

MHI  
Copy 3

FM 25-10

WAR DEPARTMENT

**BASIC FIELD MANUAL**



**MOTOR TRANSPORT**

FM 25-10

# BASIC FIELD MANUAL



## MOTOR TRANSPORT

---

Prepared under direction of the  
Chief of Field Artillery



UNITED STATES  
GOVERNMENT PRINTING OFFICE  
WASHINGTON : 1939

---

For sale by the Superintendent of Documents, Washington, D. C. - Price 20 cents

WAR DEPARTMENT,  
WASHINGTON, *September 18, 1939.*

FM 25-10, Basic Field Manual, Motor Transport, is published for the information and guidance of all concerned.

[A. G. 062.11 (12-13-37).]

BY ORDER OF THE SECRETARY OF WAR:

G. C. MARSHALL,  
*Chief of Staff.*

OFFICIAL:

E. S. ADAMS,  
*Major General,*  
*The Adjutant General.*

## TABLE OF CONTENTS

	Paragraphs	Pages
Chapter 1. General.....	1-6	1-4
Chapter 2. The driver.		
Section I. General.....	7-8	4-5
II. Preliminary instruction.....	9-22	5-12
III. Driving instruction.....	23-37	12-26
IV. Maintenance.....	38-49	26-33
V. Examination and operator's permit.....	50-51	33
Chapter 3. Marches.		
Section I. General.....	52-58	34-39
II. Types.....	59-62	39-42
III. March technique.....	63-65	42-47
IV. Organization for a march.....	66-68	47-52
V. Logistics.....	69-78	52-73
VI. Orders.....	79-84	73-75
VII. Reconnaissance.....	85-94	75-83
VIII. Defense against aircraft and mechanized forces.....	95-96	83-88
IX. Execution of the march.....	97-113	88-98
X. Traffic control, restrictions, and circulation.....	114-117	98-101
Chapter 4. Pioneer work, field expedients, and difficult operation.		
Section I. Pioneer parties.....	118-120	101-106
II. Field expedients.....	121-137	106-120
III. Difficult operations.....	138-153	120-131
Chapter 5. Military automotive maintenance.		
Section I. General.....	154	132-133
II. Echelons of maintenance.....	155-159	133-144
III. Maintenance operations.....	160-163	144-152
IV. March maintenance.....	164-169	152-155
V. Lubrication.....	170-175	156-163
VI. Inspections.....	176-179	163-166
VII. Records and reports.....	180-182	166-169
Chapter 6. Loading for movement by rail or water.		
Section I. Movements by rail.....	183-188	169-175
II. Movements by water.....	189-193	175-176
Appendix I. Schedule of instruction—Driver training.....		177-184
II. Automotive operations and maintenance sheet.....		185-186
III. Inspection report of vehicles shipped by rail or water.....		187
Index.....		189-194

## BASIC FIELD MANUAL

## MOTOR TRANSPORT

(The matter contained herein supersedes Part Two, Motors and Motor Transport (Provisional), BFM, Volume V, Transport, September 23, 1936, and TR 75-85, September 23, 1924.)

## CHAPTER 1

## GENERAL

■ 1. DEFINITION.—The term "motor transport," as used in the military service, applies to motor-propelled vehicles used for transporting military personnel, weapons, and supplies.

■ 2. SCOPE.—The principles set forth in this manual apply primarily to the operation, inspection, and maintenance of motor transport and to the training and duties of the operating and maintenance personnel. They are of general application and are not confined to any particular type of motor vehicle.

■ 3. REFERENCES.—*a. Army Regulations.*

(1) AR 30-955, Transportation of Supplies.

(2) AR 40-75, Ambulances—General Provisions.

(3) AR 730-10, Fuel and Lubricants for Motor Vehicles and Equipment Used for Training Purposes.

(4) AR 850-5, Marking of Clothing, Equipment, Vehicles, and Property.

(5) AR 850-10, Registration and Inventory of Motor Vehicles.

(6) AR 850-15, Military Motor Vehicles.

*b. Other publications.*

(1) Circulars 1-10, OQMG, Motor Transportation.

(2) Quartermaster Technical Service Bulletins.

(3) Technical Regulations.

(4) Training Regulations.

(5) Field Manuals for the arms.

(6) Manufacturers' shop repair manuals.

■ 4. EMPLOYMENT.—*a. Uses.*—Military motor transport is used for the movement of troops, matériel, and supplies in both strategic and tactical operations. All types of movements are included, from those of small units by organic transport to those of large forces by the army motor pool.

*b. Supplementary transportation.*—When commercial motor vehicles are used for emergency troop movements, special consideration must be given to their nonuniformity.

■ 5. MOTOR TRANSPORT POOLS.—In general it will be found that a pooling of effort in the use of motor transport will give the most efficient and economical results (AR 850-15).

*a. Administrative pool.*—Ordinarily, when motor transport is pooled, it is done administratively. In this type of pool, the vehicles and personnel remain with the organizations to which they are assigned and operate from the organization motor parks.

*b. Physical pool.*—In some cases the actual forming of a physical pool of vehicles and personnel is advisable. This is normally confined to the pooling of motor transport units and on rare occasions to tactical vehicles, although a large pool of vehicles will be assigned for army use in actual combat.

■ 6. REQUIREMENTS FOR EFFICIENT OPERATION.—*a. Assignment of drivers.*—A driver and, if authorized, an assistant driver should be assigned to each motor vehicle. Except for instruction, inspection, or other like purposes, the vehicle should not be operated by other drivers if it can be avoided.

*b. Vehicle abuse.*—Vehicle abuse is the chief cause of mechanical failures, excessive operating and maintenance costs, and general unsatisfactory performance of the motor vehicle and its component parts. The following forms of vehicle abuse should be prohibited:

(1) Improper use of controls, particularly gear shift, clutch, brakes, and choke.

(2) Racing engine, especially when cold.

(3) Overspeeding, particularly over rough roads and across country.

(4) Improper lubrication.

(5) Deferred maintenance, including lack of proper servicing and adjustments.

(6) Lack of systematic inspection and follow-up.

(7) Overloading and improper loading.

*c. Speed limits.*—(1) The caution plate mounted on a motor vehicle indicates the maximum safe speed for which the vehicle is designed. In no case should this speed be exceeded.

(2) Fast driving over rough, slippery, or congested roads should not be permitted.

(3) Applicable speed limits set by State or local regulations should not be exceeded.

(4) Regulated governors, when installed, should be set and sealed at the maximum speed considered safe and not to exceed that indicated on the name and caution plate.

(5) (a) Tanks and combat cars will be driven habitually on the tachometer in an appropriate gear and at not to exceed the prescribed speed in engine revolutions per minute.

(b) In the conduct of marches with columns which contain tanks or combat cars, the pace will be set by a leading vehicle at such a rate as will insure that all tanks or combat cars in the column can keep up without exceeding the prescribed economical speed in engine revolutions.

(c) When passing through towns and villages, a proper reduction in speed will be directed by the column commander, who should control the march in such manner as to insure the safety of spectators and civilian traffic and to prevent prolonged operation at low speeds in a high gear.

*d. Factors affecting operation.*—(1) Factors which materially affect the service rendered by motor vehicles should be impressed on all operating and command personnel who are concerned with the supervision, operation, maintenance, and inspection of motor-transport equipment. These factors are—

(a) Proper selection, training, and discipline of operating and maintenance personnel.

(b) Strict supervision and control of operations by commissioned personnel.

(c) Organized maintenance with adequate repair facilities and the performance of routine maintenance and inspection functions.

(d) Serviceable mechanical condition of vehicles.

(e) Recognition of the capabilities and limitations of all types of vehicles in operation.

(f) Careful reconnaissance of routes to be traveled.

(g) Recognition of the capabilities and limitations of the drivers.

(h) Training and experience of the commissioned and noncommissioned personnel.

(2) The necessity for control, for constant and intelligent supervision, and for proper selection, training, and discipline of the operating and maintenance personnel cannot be stressed too forcibly. The discipline required of personnel in organizations operating motor vehicles is that discipline which will guarantee strict adherence to the instructions received in training and will result in the proper operation and maintenance of motor transportation. Selection and training of personnel are covered in subsequent chapters.

## CHAPTER 2

### THE DRIVER

	Paragraphs
SECTION I. General.....	7-8
II. Preliminary instruction.....	9-22
III. Driving instruction.....	23-37
IV. Maintenance.....	38-49
V. Examination and operator's permit.....	50-51

#### SECTION I

#### GENERAL

■ 7. TRAINING.—The manner in which the individual drivers perform their duties determines the mobility and dependability of the motor vehicle fleet as well as that of the single vehicle. To train drivers who are competent to operate the vehicles of their organizations either alone or in convoy, a systematic and progressive course of instruction must be given. Training schedules should include a maximum of practical instruction and a minimum of class-room work. (See appendix I.)



■ 8. SELECTION OF DRIVERS.—An individual selected for training as a motor vehicle driver should be dependable, alert, sober, steady, and ambitious, and should have good judgment and mechanical sense. He should be able to drive a motor vehicle satisfactorily under military conditions by day or night. He should react quickly and properly in given test situations. He should be able to differentiate promptly between red, green, and amber lights. These tests may all be conducted in the unit.

## SECTION II

### PRELIMINARY INSTRUCTION

■ 9. RESPONSIBILITY.—The instructor should explain the object of the training to be given and the responsibility of the driver in making his organization an efficient one. This responsibility includes—

a. Operation and maintenance of motor vehicles in accordance with instructions.

b. Care and condition of vehicle tools and equipment.

c. Loads and loading.

d. Reports and records.

■ 10. ORGANIZATION OF THE MOTOR PARK.—The driver should be acquainted with the organization of the motor park and with his duties in connection therewith.

■ 11. FIRE PRECAUTIONS AND FIRE FIGHTING.—Motor vehicles, shops, and parks are constantly exposed to fires. Drivers must, therefore, be instructed in and required to comply with pertinent fire-prevention regulations. In addition they must be instructed and drilled in the use of fire-fighting equipment and in removing vehicles and other property from the danger area.

■ 12. ACCIDENT PREVENTION.—The formulation and observance of definite rules will eliminate the majority of accidents incident to the operation and maintenance of motor vehicles. These rules should include the following:

a. Place the transmission gear-shift lever in neutral and set the hand brake before hand cranking an engine or starting it with the starting motor.

*b.* Make sure the way is clear before a vehicle is moved. If the driver cannot see the road, he should be directed by a dismounted individual. This is particularly important when a vehicle is backed or is moved through bivouac areas and across country at night without lights.

*c.* Stop the engine before anyone gets under a vehicle. If it is necessary for a mechanic to work under the vehicle while the engine is running, precaution must be taken that the vehicle cannot move accidentally.

*d.* Block up a vehicle safely before the wheels are removed. Do not place reliance on jacks.

*e.* Remove the battery when a vehicle is taken into the shop for major repairs.

*f.* Provide ample ventilation for garages, shops, vehicle cabs, and vehicles carrying personnel.

*g.* Do not operate motor vehicle engines in a garage or shop longer than necessary to move the vehicle in or out, unless the vehicle is standing near wide open doors or the exhaust gases are removed through a safe outlet fixture.

*h.* In case of carbon monoxide poisoning, remove the patient to open air, keep him quiet, apply artificial respiration and warmth, and obtain medical assistance as soon as possible.

■ 13. NOMENCLATURE AND GENERAL PURPOSE OF MAJOR UNITS OF THE MOTOR VEHICLE.—Preliminary instruction should cover the nomenclature and purpose of major assemblies only, in order that the driver may become familiar with his vehicle without being confused by details. Detailed instruction in nomenclature, function, operation, use, lubrication, maintenance, and limitations of motor vehicles, and the nomenclature, care, and use of vehicular tools and equipment should be given in subsequent periods.

■ 14. MOTOR VEHICLE CONTROLS.—The day-to-day condition and the ultimate service of a motor vehicle, as well as safety to life and property, depend upon the condition and proper use of the controls. Consequently, careful instruction and supervision are necessary to insure the correct use of these important devices. The following controls should be explained and demonstrated:

*a.* Carburetor choke control (if not automatic).

- b. Carburetor throttle control, to include accelerator.
- c. Ignition switch.
- d. Spark control (if not automatic).
- e. Transmission gearshift lever.
- f. Subtransmission gearshift lever.
- g. Clutch pedal.
- h. Steering wheel.
- i. Brakes, hand and foot.

■ 15. CLUTCH, TRANSMISSION, AND BRAKES.—*a.* Drivers should familiarize themselves with the location and manipulation of the clutch pedal, the transmission gear shift lever, and the brake lever and brake pedal before actual driving instruction starts. For this purpose the motor vehicles should be blocked up securely with all wheels off the ground.

*b.* When the candidate first gets into the driver's seat, he should be required to assume the correct position; that is, sit erect, without stiffness, squarely behind the steering wheel; head erect, eyes looking to the front; hands on opposite sides of the steering wheel, on a horizontal line generally through the center of the wheel, grasping the steering wheel rim firmly but without tenseness; both feet flat on the floor boards except when actually manipulating the accelerator, the clutch and brake pedals, or the starter switch.

*c.* After the candidate has familiarized himself with the location and manipulation of the controls, the instructor should start and warm up the engine. He should then demonstrate the operation of the accelerator; coordinated movements of the accelerator, clutch pedal, and transmission gear shift lever; gear shifting, to include reverse; operation of the brake controls; manipulation of the steering wheel; and the use of the engine as a brake. Upon completion of the demonstration, the candidate should take the driver's seat and practice manipulating the controls until he becomes reasonably proficient. Careful supervision should be exercised to insure correct performance.

*d.* Careful supervision should be exercised over the following:

(1) *Engine speeds.*—The engine must not be raced. During the preliminary instruction period, the accelerator may be blocked to limit the engine speed. The accelerator should

be released when shifting gears (except when double clutching, par. 24) and depressed gradually when the load is applied to the engine.

(2) *Clutch pedal*.—To disengage the clutch, the clutch pedal should be depressed to the limit of its travel. To engage the clutch, the clutch pedal should be released gradually. The results to be anticipated if the clutch pedal is released too rapidly, and the injurious effects of allowing the foot to rest on the clutch pedal should be explained.

(3) *Transmission gear shift lever*.—The lever should be moved smoothly but firmly from one position to another and must never be forced.

(4) *Position of the feet*.—While actually driving, the right foot should rest on the accelerator and the left foot on the floor boards. *The feet should be placed on the control pedals only when the pedals are to be operated.*

(5) *Brakes*.—Brakes should be applied gradually with just enough pressure to accomplish the desired results. The braking effort of the engine should be used when retarding the vehicle speed, the clutch being disengaged in time to prevent stalling the engine.

■ 16. AID TO MOTOR VEHICLE CONTROL.—Although the devices given below cannot be classed as controls, they aid in motor vehicle control and should be explained and demonstrated.

- a. Light switches.
- b. Horn button.
- c. Rear-view mirror.
- d. Windshield wiper.
- e. Speedometer.

■ 17. INSTRUMENT-BOARD GAGES.—Gages are placed on the instrument panel in plain view of the driver to give information concerning certain assemblies and systems of the motor vehicle. The instructor should explain the purpose of each gage, give its normal reading, and tell the driver what to do when an abnormal reading is observed.

■ 18. INSPECTION BEFORE OPERATION.—A motor vehicle is not ready for service until certain items have been checked. Before moving his vehicle from its overnight parking position, the driver, under proper supervision, makes this inspection

and reports the results to his chief of section or other designated individual. The driver is held strictly responsible that all requirements are met. Items are checked as follows:

*a.* Before starting engine—

(1) The surface (ground or floor) under the vehicle for evidence of leaks.

(2) The radiator for proper amount of water and to see that air passages are open.

(3) The gasoline tank for proper amount of gasoline.

(4) The crankcase for lubricating oil, Spare oil if required.

(5) The engine for loose parts or electrical connections.

(6) Pneumatic tires, including spares, for proper inflation.

(7) The horn and all lights for proper functioning.

(8) Front axle and steering linkage.

(9) Tools and necessary equipment.

(10) Carried load for condition and distribution.

(11) Towed load for condition, attachment to prime mover, and brake connections.

(12) All transmissions and power take-offs in neutral.

(13) Drain valve in air brake storage tanks closed.

*b.* After starting engine—

(1) Fan operation.

(2) Engine for loose parts and unusual noises.

(3) Proper functioning of all dashboard instruments as engine comes to operating temperature.

(4) Action of windshield wiper.

(5) The vehicle is moved, and the clutch, transmission, steering, and brakes are tested.

■ 19. STARTING AND WARMING UP THE ENGINE.—Special attention should be devoted to the proper starting and warm-up period in order that unnecessary engine wear may be prevented. The procedure outlined below is satisfactory under average operating conditions:

*a.* Set the hand brake.

*b.* Place the transmission gear shift lever in the neutral position.

*c.* Set the choke control and the hand throttle control. Consider the peculiarities of the engine, engine temperature,

fuel, and manufacturer's instructions. Care should be taken to avoid excessive use of the choke.

d. Disengage the clutch.

e. Turn on the ignition.

f. Engage the starter switch contacts. Release the starter switch contacts as soon as the engine starts.

(1) If the starter device fails to engage the engine flywheel, release the starter switch contacts and allow the starter armature to come to rest. Try again. If the device still fails to engage, report to the chief of section or other designated person.

(2) If the starter device engages the engine flywheel and locks, release the starter switch contacts, turn off the ignition, place the transmission in high gear, release the brake, and rock the vehicle backward. If the starter device fails to disengage, place the transmission in neutral and report as above.

(3) If the starter device engages the engine flywheel and the engine fails to start after several attempts, report as above. The starter switch contacts should not be engaged for periods longer than 10 to 15 seconds.

g. If the engine is magneto equipped and hand cranking is necessary, follow the manufacturer's instructions.

h. Adjust the setting of the dash throttle control to give the desired engine speed. Release the clutch pedal.

i. Allow the engine to warm up to the proper operating temperature, opening the choke as rapidly as the engine temperature permits. *The choke should be closed, or partially closed, only as long as necessary and should never be used excessively.* The engine has reached a safe operating temperature when upon acceleration with the choke wide open there is no backfiring, and when the oil pressure needle remains below the maximum reading on the oil pressure gage scale with the engine running at its normal operating speed.

■ 20. INSPECTION DURING OPERATION.—During operation the driver should be alert to detect malfunctioning of the engine. He should be trained to detect unusual engine sounds or noises and to follow the proper procedure when they occur. He should frequently glance at the instrument panel gages

and know what to do when abnormal readings are observed. Before vehicles start on a march or are dispatched on individual missions, careful instructions should be given to drivers concerning the action to be taken when operating troubles occur. Only under exceptional circumstances should a motor vehicle be operated after trouble has developed which will prove serious if operation is continued. When in doubt, the engine should be stopped and assistance obtained. Inspection during operation applies to the entire vehicle and should be emphasized throughout the driving instruction period.

■ 21. INSPECTION AT THE HALT.—At each scheduled halt during the march or at intervals during a day's work on dispatch, the driver should make a careful inspection of his vehicle to determine its general mechanical condition. Detection and correction of defects should give reasonable assurance that the vehicle is ready for continued operation. If the defects cannot be corrected during the halt, proper disposition of the vehicle should be made so that unnecessary delay may be avoided and a major failure prevented. Drivers and maintenance personnel should make full use of halt periods to place all vehicles in condition for continued uninterrupted service. A suitable general routine, the sequence of which may be altered to suit a particular type of vehicle, is as follows:

a. Allow the engine to run a short time. Listen for unusual noises.

b. Walk around the vehicle, looking carefully for fuel, oil, and water leaks.

c. Inspect all tires for inflation, cuts, nails, stones, and indications of misalignment. On track-laying vehicles, examine tracks for adjustment and for worn, loose, broken, or missing parts. Note condition of traction devices, if used.

d. Feel brake bands, wheel hubs, and gear cases for evidence of overheating.

e. Inspect the lights, if traveling at night with lights.

f. Check the amount of fuel in the tank.

g. Check the quantity of water in the radiator.

h. Check the quantity and condition of the oil in the crankcase or oil reservoir. Add oil if necessary.

*i.* Inspect the condition of the cargo and towed load, if any.

*j.* Report promptly the result of the inspection to the chief of section or other designated individual.

■ 22. INSPECTION AFTER OPERATION.—At the conclusion of the day's work, the driver should make an inspection similar to that made at halts but more thorough and detailed. Repair operations performed by the driver are determined by his ability and the equipment available for his use. If defects cannot be corrected, they should be reported promptly to the chief of section or other designated individual. The inspection should be followed by preventive maintenance (sec. IV). A suitable routine is as follows:

*a.* Check all items included in the inspection at the halt, testing lights in all cases (par. 21).

*b.* Raise the hood and look for loose, missing, or broken parts, and indications of improper operation.

*c.* Examine grease seals for evidence of failure or over-lubrication.

*d.* Check front axle, steering gear, and linkage, and front springs for condition, alinement, and attachment.

*e.* Check rear axle and rear springs for condition, alinement, and attachment.

*f.* Examine propeller shaft for condition, tightness of connections, and foreign materials wrapped around the shaft.

*g.* Examine brake linkage for loose, worn, lost, or broken parts.

*h.* Check body bolts; tighten or replace as required.

*i.* Check tools and equipment.

*j.* Report results (par. 21 *j*).

### SECTION III

#### DRIVING INSTRUCTION

■ 23. GENERAL RULE.—Careful instruction and painstaking supervision must be the rule during the driving instruction period to insure that the driver learns the correct performance of his duties and forms the proper habits.

■ 24. GEAR SHIFTING AND USE OF CLUTCH.—*a.* Preliminary driving should be conducted on a large open field where



steering is of secondary importance. A qualified instructor should accompany each candidate to explain procedure, demonstrate application, and insure correct driver performance. Candidates should be permitted to drive at will with the transmission in the lower gear ratios until they are reasonably familiar with the operation and control of their vehicles, after which the driving should become progressively more difficult.

b. After the driver has become reasonably proficient in shifting from lower to higher gears, he should receive instruction in double clutching, the procedure for which is as follows:

(1) Disengage the clutch and shift to neutral; at the same time decelerate the engine.

(2) Engage the clutch and accelerate to an engine speed slightly in excess of that required in the lower gear to maintain the vehicle speed.

(3) Disengage the clutch and shift to the next lower gear; at the same time slightly decelerate the engine.

(4) Engage the clutch; at the same time accelerate the engine to effect clutch engagement without shock to the power transmission system.

(5) Practice double clutching until proficient in shifting from a higher to a lower gear.

c. On medium and heavy vehicles it is sometimes difficult to shift from a low gear to a higher gear without clashing the gear teeth. The clashing may be avoided by using the double-clutching procedure *without accelerating the engine during the shift*.

■ 25. USE OF TRANSMISSION AND AUXILIARY TRANSMISSION.—a. A transmission is provided so that the engine may be permitted to run at a speed at which sufficient horsepower is developed, and at the same time permit the vehicle to travel at a speed commensurate with the road and load conditions. The addition of an auxiliary transmission, sometimes included as a part of the power transmission system, increases the number of gear ratios available and permits greater flexibility in the transmission of power.

b. Drivers should understand what happens when the gear shift lever is moved and must be practiced in the

manipulation of the controls and the proper use of the transmission and auxiliary transmission. An engine should never be permitted to labor unduly when a change in transmission-gear ratios would lighten the load.

c. The auxiliary transmission normally provided on military motor vehicles has two gear ratios: high, which does not change the gear ratios provided by the main transmission; and low, which gives a greater gear reduction (higher reduction ratio) than that provided by the main transmission. The auxiliary transmission is controlled by a gear-shift lever in the driver's compartment. The high range is used for normal operation and the low range for heavy duty. *The ratios in the auxiliary transmission of most types of vehicles should not be changed when the vehicle is in motion.*

■ 26. USE OF BRAKES.—a. The brakes should be in such condition that a hard application will cause all wheels to be locked, but the driver must realize that the maximum retarding effect occurs just before the wheels lock. Intermittent applications will reduce the wear of brake linings and drums. Application of the brakes should be gradual and with just enough force to accomplish the desired result.

b. Judicious use of the braking effect of the engine will increase the serviceable life of the brake linings and drums. When the driver anticipates a stop, he should make full use of the engine braking effect, disengaging the clutch in time to avoid stalling the engine. When descending hills, a driver should use the engine as a brake by selecting and engaging the proper gear ratio, and use the intermittent application of the brakes to prevent overspeeding the engine. The ignition should not be turned off. The engine speed when descending a hill should be no greater than the speed necessary to ascend the hill when using the same transmission gear ratio. On steep hills the gear train necessary to give the desired results should be engaged before the vehicle is committed to the hill. Attempting to shift gears after the vehicle has started down a steep slope may result in a runaway vehicle.

c. At all times a driver should know the performance and the general condition of his vehicle brakes. When operating

conditions require vehicles to move through water, the brakes become very inefficient because of moisture on the brake linings and in the brake drums. If the distance to be traversed is short, considerable water may be kept out of the brake assemblies by a slight application of the brakes while the vehicle is in the water. After passing through water, the brakes should be set slightly and the vehicle operated until sufficient heat has been generated to dry the brakes.

d. Vehicle stopping distances are dependent upon the nature and condition of the road surface, the condition of the brakes, the weight of the load, and the kind and condition of tire treads. When operating at a speed of 20 miles per hour on a dry, smooth, level road free from loose material, every motor vehicle or combination of motor vehicles should be capable, at all times and under all conditions of loading, of stopping within the following distances when the foot brake is applied:

Vehicles or combination of vehicles having brakes on all wheels.....	30 feet
Vehicles or combination of vehicles not having brakes on all wheels.....	45 feet

e. Drivers should be cautioned against the use of brakes when a vehicle is skidding and when it is being operated on ice-covered roads.

■ 27. TURNING, BACKING, AND PARKING.—a. After the driver has acquired facility in starting, simple driving, and stopping his vehicle, he should be practiced in maneuvering in difficult places. The ability to turn his vehicle in a confined space, to back it accurately, and to park it properly under various conditions are essential requirements for the motor vehicle driver.

b. Turns should be made at speeds commensurate with the road, load, and traffic conditions. A vehicle driver should always give the appropriate arm, electrical, or mechanical signal in sufficient time to afford ample warning that a change in direction is to be made. Turns should start and end in appropriate traffic lanes and should be made with as little confusion to other traffic as possible. At least one hand should be kept on the steering wheel when the vehicle is in motion.

c. A driver should never back a vehicle until he is certain that the way is clear. When the driver's view is obstructed, he should act as directed by an assistant on the ground. When backing unassisted, the driver should always give warning of the movement by sounding his horn. Considerable practice is necessary to back a vehicle safely and accurately. This is particularly true when the driver is required to back a towed load.

d. Parking includes turning and forward or backward movement of the vehicle in more or less restricted spaces. Factors which should be given consideration when parking are space for maneuver of vehicle, solid standing, interference with other traffic, and cover if applicable.

e. The use of stake driving courses will permit instruction and practice without other traffic interference and will make closer supervision possible. The instruction courses shown in figures 1, 2, and 3 are recommended.

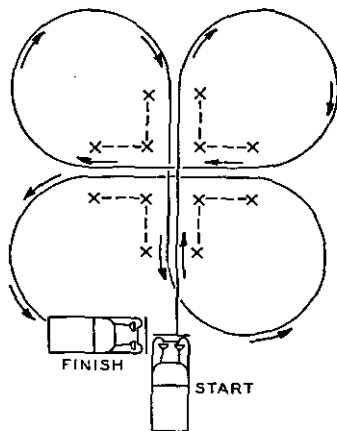

(The figure should be symmetrical, with the stakes placed to allow an over-all side clearance of approximately 18 inches.)

FIGURE 1.—Reverse turning course.

■ 28. STARTING ENGINE UNDER UNUSUAL OPERATING CONDITIONS.—a. *Gasoline boiling in carburetor.*—Some engines when stopped after having reached an operating tempera-

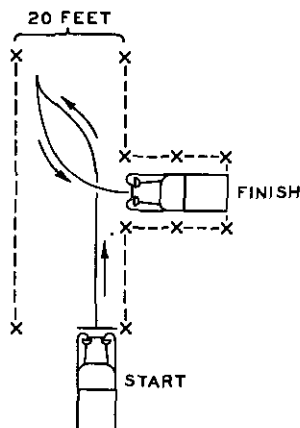

(The figure should be symmetrical, with the stakes placed to allow an over-all side clearance of approximately 18 inches.)

FIGURE 2.—Backing course.

ture radiate enough heat to cause boiling of the gasoline in the carburetor float chamber. This condition, which is not uncommon during hot weather operation, causes a rich mixture in the intake manifold. To start the engine, the hand throttle is fully opened, the carburetor choke is left in the normal operating position, and the engine started. The throttle should be adjusted to the desired engine speed only after the engine begins to run smoothly. Intermittent depression of the accelerator when the engine is not running will also produce a rich mixture in the intake manifold; the procedure outlined above should be followed in starting the engine.

*b. Vapor lock.*—Vapor lock is caused by vaporization of the fuel before it leaves the carburetor jets. This condition results in a mixture that is too lean to sustain engine operation. The best solution is to wait until the fuel cools and returns to liquid form. After liquefaction takes place, the engine may be started in the normal manner.

■ 29. SIGNALS.—*a. Drivers' arm signals.*—Before a driver changes the direction or slows the speed of his vehicle, he

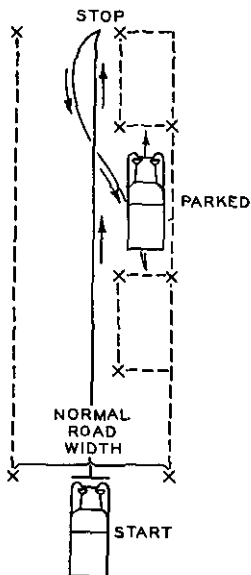

(Stakes should be placed so that when parked the vehicle will have an over-all longitudinal clearance of approximately 10 feet and a lateral clearance of approximately 3 feet.)

FIGURE 3.—Parking course.

should give the appropriate arm signal to warn other drivers of the contemplated change. Arm signals should be clearly made and should be given in time to afford ample warning. There is as yet no standard set of drivers' arm signals. Drivers of military vehicles operated in civilian traffic should use the arm signals prescribed for the locality in which the vehicle is being operated. Drivers' arm signals which are satisfactory for military use are:

- (1) *Turn right.*—Extend the left arm outward at an angle of  $45^{\circ}$  above the horizontal.
- (2) *Turn left.*—Extend the left arm outward horizontally.
- (3) *Slow or stop.*—Extend the left arm outward to an angle of  $45^{\circ}$  below the horizontal.

(4) *Pass and keep going.*—Extend the left arm horizontally and describe small circles toward the front with the hand.

b. Commands and signals commonly used in a motorized unit are:

(1) *Start engine.*—Simulate cranking.

(2) *Report when ready to move* (given by unit commander).—Extend the arm vertically, fingers extended and joined.

(3) *Ready to start.*—Senior in truck stands on running board, faces leader, and extends the arm vertically, fingers extended and joined, palm toward the leader.

(4) *Stop engines.*—Cross arms in front of body at the waist and then move them sharply to the side. Repeat several times.

(5) *Increase speed.*—Carry closed fist to the shoulder and rapidly thrust it vertically upward several times to the full extent of the arm.

(6) *Prepare to Mount.*—Extend the arm horizontally to the side, palm up, and wave the arm upward several times.

(7) *Prepare to Dismount.*—Extend the arm diagonally upward to the side, palm down, and wave the arm downward several times.

(8) *Close up.*—Extend the arms horizontally straight to the front, palms in. Move the hands together and then resume the first position. Repeat several times.

(9) *Open up.*—Extend the arms horizontally straight to the front, palms out. Move the hands outward and then resume the first position. Repeat several times.

(10) *Immediate danger.*—Use three long blasts of whistle or automobile horn repeated several times, or three equally spaced shots with rifle or pistol. The person giving the signal points in the direction of impending danger. This signal is reserved for warning of air, mechanized attack, or other immediate and grave danger.

(11) *Drivers to turn around simultaneously.*—Extend both arms horizontally toward the drivers and describe small vertical circles, then signal forward in the desired new direction. When the distance between vehicles permits and the convoy is long, this signal may be given by a motorcycle messenger passing back along the column.

c. Other authorized signals may be found in the manuals for the arms and services.

d. Electrical and mechanical signals should be used when vehicles are so equipped.

■ 30. ROAD RULES AND TRAFFIC REGULATIONS.—Observance of prescribed road rules and traffic regulations permits the movement of traffic with a maximum of safety and a minimum of confusion and control. The following general rules should be observed by all drivers:

a. Vehicles will keep to the right of the road.

b. The appropriate warning signal will be given before changing direction, slowing down, or stopping.

c. The driver will be alert and pay attention to road signs, convoy signals, and traffic directions.

d. The right-of-way will be given promptly to faster moving vehicles.

e. Speed will be reduced on dry, dusty roads.

f. Speeds for night driving, without lights, will be determined by road conditions, degree of visibility, and skill of the drivers.

g. Lights will be dimmed when meeting another vehicle, if driving at night with lights.

h. Unnecessary use of horns is prohibited.

i. A disabled vehicle will not delay unnecessarily the march of a column.

j. A vehicle will never pass traffic moving in the same direction—

(1) When going around a corner or blind curve.

(2) When ascending or descending hills unless safe passage is assured.

(3) At street intersections or crossroads.

(4) When the road is not wide enough to allow at least 2 feet between vehicles.

k. A driver who has been assigned a place in a column will not pass another vehicle in the same column unless that vehicle is disabled or he receives a signal to pass.

l. A driver when meeting and passing an oncoming vehicle will—

(1) Pass on the right giving at least half the road.

(2) Slow down if operating conditions are hazardous.



(3) Permit the vehicle having a clear road ahead to have the right-of-way.

*m.* Vehicles will be halted at railroad crossings not guarded by military personnel or civilian watchmen.

*n.* Vehicles will be slowed down to a safe stopping speed at all road intersections not covered by traffic control personnel or traffic control devices.

*o.* Vehicles will not be permitted to coast down hills with the clutch disengaged or the transmission in neutral.

*p.* Vehicles will clear the roadway before being halted.

*q.* Vehicles will not be halted on bridges, in defiles, at points where the vision of other drivers is restricted, or in such manner as to block cross traffic or entering side traffic.

*r.* During the halt—

(1) The engine will be stopped if the vehicle is to stand longer than a few minutes.

(2) All personnel will keep to the right of the vehicles.

(3) The prescribed inspection and maintenance functions will be performed (par. 21).

*s.* Passengers will not mount or dismount from moving vehicles.

*t.* State and local traffic regulations will be observed unless otherwise ordered.

■ 31. MARCHING.—*a.* Successful marching requires well-trained drivers and teamwork on the part of all elements of the command. Drivers must therefore be trained in *march organization, march formations, march regulations, camouflage and concealment of vehicles, and procedure in case of air or mechanized attack (ch. 3)*. Through instruction and the enforcement of regulations, a degree of *march discipline* is attained which enables an organization to pass over roads with a maximum of speed and safety and a minimum of interference with other traffic, and to arrive at its destination in the best possible condition.

*b.* During training in close column marching, special attention should be paid to safe driving distances between vehicles. These distances, which vary with vehicle speeds, should be prescribed initially to aid the driver in visualizing his proper place. The following rule, properly modified to meet special conditions, gives the minimum distances for

safe marching: *The distance in yards between vehicles should be twice the speedometer reading.*

c. When marching over rolling terrain, a higher rate of march and smoother marching may be attained if drivers are permitted, within maximum prescribed speed, to increase the speed of their vehicles before commencing to climb. Vehicles should be slowed down while going down grades to compensate for the distance gained when running a hill. This practice will prevent excessive jamming and will allow drivers to take advantage of power and momentum to negotiate hills without excessive shifting of gears. Running hills is particularly advantageous when march columns are made up of mixed vehicles.

■ 32. CHAINS AND TRACTION DEVICES.—Chains and traction devices should always accompany the vehicle to which they pertain. They should be kept in serviceable condition and in proper adjustment to permit installation with a minimum of delay. Chains and traction devices should be removed when the necessity for their use no longer exists in order to prevent unnecessary damage to roads.

a. *Chains.*—Chains are generally necessary in mud, sand, snow, or slush ice. Chains should not be used on ice-covered roads when they cannot bite into the ice. The following general rules apply to the application and use of chains:

(1) The chains are applied before the vehicle becomes mired.

(2) The chains are so applied that rotation of the wheel tends to close the chain fastenings. If improperly installed, rotation of the wheel opens the fastening and the chain will be lost.

(3) Fairly loose adjustment gives better traction and less tire wear than tight adjustment.

(4) On all wheel-drive vehicles without center differential or other compensating device, chains must be installed on all wheels to prevent unnecessary strain.

(5) When only single chains are provided for dual-tired wheels, they should be installed on the outside tires.

b. *Traction devices.*—(1) *Giant tire lugs.*—Giant tire lugs provided for some military motor vehicles give better traction without increasing flotation. They are made for use on

dual-tired wheels. The general rules for the application and use of chains apply, with few exceptions, to the application and use of giant tire lugs.

(2) *Traction bands*.—Traction devices such as circular and oval bands are provided for some military motor vehicles to give increased traction and flotation. Circular bands should be chained to the wheel to prevent slippage of the tires inside the band. Oval bands are used on bogie axles and should be applied and adjusted in accordance with manufacturers' instructions.

(3) *Tractor grousers*.—Grousers increase traction but do not improve the flotation qualities of the vehicle. Two general types of grousers, removable and integral, are used on tractors provided for the military service. The removable type should be applied when necessity for their use arises. The integral type grouser is a part of the track shoe and cannot be removed, but the grouser action may be eliminated by the use of street plates bolted to the track shoes.

■ 33. DIFFICULT DRIVING.—*a.* After the driver has acquired facility in driving and maneuvering, he should be taken through a series of progressively increasing difficulties, such as ditches, ruts, chuckholes, woods, slippery roads, mud, difficult curves, and up and down steep slopes until he becomes reasonably proficient in handling his vehicle under all conditions. This training should include field expedients and the application and use of chains and traction devices.

*b.* The training should start with individual performances and empty vehicles and should progress to group performances with loaded vehicles and with towed loads if used in the organization.

■ 34. NIGHT DRIVING.—*a.* Movements under cover of darkness are frequently necessary in order to escape observation and gain security. In forward areas, movements must be made without lights if casualties are to be minimized and secrecy preserved. Night movements are particularly difficult because of the limited control that can be exercised and the obstacles that must be overcome. Before such movements are undertaken, drivers should be given thorough training in marching, with and without lights.

b. Training in night driving should start with empty vehicles operated over good roads with lights. Careful instructions should be issued and the road should be well marked. After the drivers have become reasonably skilled in driving with lights, they should be required to traverse the same route without lights. Provision should be made to prevent flashing of the stop light. The routes traversed should become progressively more difficult until drivers are proficient in handling their vehicles under all probable operating conditions. During this training, special attention should be paid to march discipline, to the prevention of smoking, and the use of lights. When a movement with lights is to be continued without lights, time should be allowed to accustom drivers' eyes to the changed conditions.

■ 35. LOADS AND LOADING.—In order that vehicle capacity and cargo space may be efficiently used, it is necessary that drivers have a knowledge of loads and loading. The driver ordinarily should not be required to handle cargo during the loading and unloading operations, but he should be directly charged with the following responsibilities:

a. *Maximum authorized load not exceeded unless ordered by proper authority.*—The maximum pay load, road and cross-country, and the maximum tow load are shown on the vehicle name and caution plate. These loads should not be exceeded except in case of emergency, and then only when specially authorized. Lack of knowledge of cargo weight is not an acceptable excuse for overloading. When scales are not available and cargo weight is unknown, adherence to the following general rule will prevent overloading: The position of the rear springs should be determined with the maximum authorized load. The position of the spring ends below this line indicates that the vehicle is overloaded.

b. *Proper location and reasonable distribution within the body.*—Efficient loading insures maximum use of cargo-carrying capacity and safety in transit. One loose piece of cargo may release an entire load; and, if the load is unbalanced, the vehicle is in danger of overturning, is difficult to handle, and is a menace to traffic. The following principles should be observed for correct loading:

(1) Heavy supplies should be placed at the bottom of the load and properly distributed.

(2) In building up the load, place cargo carefully to avoid shifting and distribute the weight equally on both sides of the body.

(3) Loads should not be built up too high. High loads cause swaying and danger of overturning and make the vehicle hard to handle.

(4) If the truck is not a covered vehicle, a tarpaulin should be placed over the cargo as a protection against sun, dust, or rain.

*c. Proper securing of the load to the body or to the pintle.*—(1) Loads built up above the top of the vehicle body should be securely lashed. The equipment for lashing loads on trucks consists of two 60-foot ropes which are sufficient for any ordinary cargo. Lash hooks or rings are usually provided on the bodies of cargo-carrying vehicles. The following procedure should be followed when lashing the load:

(a) Fasten the end of one rope to one of the front lash hooks or rings.

(b) Pass the rope diagonally across the top of the load, through or under the second rope support, and pull the rope tight.

(c) Pass the rope diagonally back across the top of the load, through or under the third rope support, and pull the rope tight.

(d) Continue the process until the rear of the truck has been reached and secure the end of the rope.

(e) Using the second rope, start at the other front corner of the truck and repeat the procedure, using alternate lash hooks or rings.

(2) Towed loads are attached to their prime movers or towing vehicles by means of the lunette on the towed load placed in a pintle on the towing vehicle. The pintle latch must be closed and secured before the load is moved.

*d. Safety of the load in transit.*—After the load has been placed in or attached to his vehicle, the driver is responsible for its safety until the destination is reached.

■ 36. MAP READING.—Military motor vehicle drivers should receive sufficient instruction and training in map reading

to enable them to follow routes on marked maps, to choose routes, and to recognize terrain features represented on topographic maps. Training should include the use of commercial highway maps, military topographic maps, airplane photographs, and mosaics.

■ 37. NOMENCLATURE, FUNCTIONING, AND LUBRICATION.—Training in nomenclature started in the preliminary instruction period should continue through the actual driving period. Particular attention should be paid to functioning and lubrication. As a result of this training and the actual handling of the vehicle, the driver should be able to recognize immediately any abnormal condition, either in the engine performance or in general operation.

#### SECTION IV

#### MAINTENANCE

■ 38. GENERAL.—*a.* Proper maintenance is essential to economical operation of motor vehicles. This entails the coordination of maintenance functions. Those charged to the operating organizations embrace preventive maintenance, minor repairs, and unit replacement possible within the limits of the time available, utilizing hand tools and light portable equipment provided in Tables of Basic Allowances.

*b.* In the organization maintenance set-up, the driver and assistant driver are responsible for preventive maintenance functions within the limits of their ability and the equipment available for their use. Driver preventive maintenance functions include inspection, lubrication, tightening, servicing, and cleaning of motor vehicles, the avoidance of vehicle abuse, and the performance of emergency adjustments and repairs. Lubrication, tightening, servicing, and cleaning operations may be included under the general heading of caretaking.

*c.* Efficient enforcement of preventive maintenance is the responsibility of commanding officers of all units operating motor vehicles. In carrying out this function, definite maintenance duties will be assigned the motor vehicle operator and he will be prohibited, except in an emergency, from performing any maintenance function not specifically assigned. (See AR 850-15.)

*d.* When operating conditions are particularly arduous, better results may occasionally be obtained by relieving drivers and assistant drivers of all inspection and care-taking functions normally performed after operation and requiring the maintenance section or other designated personnel to perform the duties. This practice should be resorted to only when absolutely necessary.

■ 39. **INSPECTIONS.**—The driver is charged with the routine inspections described in paragraphs 18, 20, 21, and 22.

■ 40. **SERVICING.**—*a.* Servicing is defined as a check and necessary replenishment of gasoline, oil in crankcase, water or antifreeze in cooling system, and air in tires.

*b.* Precautions concerning the handling of gasoline must be rigidly enforced. When driver's trip tickets are used, the amount of gasoline should be entered on the ticket.

*c.* In the replenishment of oil in the crankcase, the following rules should be observed:

(1) Take every precaution to prevent dust and other foreign matter from entering the crankcase with the oil. Wipe out the oil measure, the spigot on the oil drum, the funnel, and the oil filler pipe with a clean cloth before refill oil touches any of the surfaces.

(2) Pour only the proper amount of oil into the crankcase. Do not overfill.

(3) Use the proper grade of oil for the season.

(4) Do not mix different makes of oil.

(5) Wipe off any oil spilled during refilling.

(6) When the driver's trip ticket is used, the driver enters on the ticket the amount of replacement oil used.

*d.* The water in the radiator should be maintained at the proper height below the overflow pipe. A hot engine should be allowed to cool before any considerable quantity of water is added to the radiator or the engine should be allowed to run and the water added very slowly. In freezing temperatures, if no antifreeze is used, care must be exercised to prevent freezing. When the cooling system must be drained, it is necessary in most engines that the cylinder block as well as the radiator be drained. Clean water, preferably soft, should be used to fill the cooling system. If conditions make it necessary to use dirty water, the cooling system

should be drained, flushed, and refilled with clean water at the earliest opportunity.

e. Air in tires is covered in paragraph 45.

■ 41. LUBRICATION.—*a.* In decentralized lubrication, the driver should be held responsible for the lubrication of all parts that cannot be damaged by overlubrication except those requiring special lubricants. Parts that should be lubricated by the driver include spring and spring shackle bolts, spring pivot seats, steering knuckle pivots, steering knuckle tie rod pins, steering gear connecting rod (drag-link) ends, clutch and brake pedal and brake lever pivots and linkage, accelerator linkage, door hinges and locks, tail gate hinges, and other slow motion friction surfaces.

*b.* Equipment furnished the driver includes a high pressure lubricator and an oilcan. The driver is responsible for the care and condition of this equipment.

*c.* Lubrication should be performed in accordance with a lubrication schedule and reports should be rendered by drivers when the lubrication is completed in order that proper records may be kept. Grease fittings and oil holes should be cleaned before lubricant is applied. Careful instruction and diligent supervision are necessary to assure good lubrication. Lubrication by the numbers is suggested as an effective method for teaching lubrication to untrained personnel.

*d.* Lubrication by drivers involves the use of only two types of lubricant: oil and chassis lubricant.

(1) The oil used for lubrication of linkages, hinges, etc., should be of the same grade as that used in the engine crankcase.

(2) The chassis lubricant used on spring and spring shackle bolts, steering knuckle pivots, etc., is of semifluid grease usually having a brilliant color and stringy consistency. Drivers must be taught to distinguish between chassis lubricant and other types of lubricants.

■ 42. TIGHTENING.—*a.* The distinction between tightening and adjusting must be definitely understood, otherwise drivers will undertake operations which they do not have the knowledge, experience, or equipment to perform. In general, adjustment involves placing moving parts or assemblies



in proper relative position and securing them in that position. Adjustments, except specified emergency adjustments, are prohibited to the driver.

b. When a driver discovers a loose or lost nut, bolt, screw, stud, or cotter key, he should tighten or replace it unless the adjustment of a part or assembly is affected. If adjustment is involved, report should be made to the chief of section or other designated individual.

c. A driver should be taught the correct use of the tools furnished for his use and the proper degree of tightness of the various nuts, bolts, and screws on his vehicle. If the drivers are not sufficiently skilled or if the proper tools are not furnished for their use, all tightening operations should be performed by the motor sergeant and mechanics.

■ 43. CLEANING.—a. A motor vehicle should be cleaned after operation to prevent hardening of dirt accumulations and to keep dust and other foreign particles from working into bearing surfaces. The body and exterior parts of the chassis should be washed, using a hose if available. Water should not be played on the engine as ignition troubles may result. Dirt should be wiped from the engine and its subunit assemblies. Gasoline should not be used to clean engines; cleaning solvent is recommended because of its greater safety. Gas and oil lines should *not* be polished. The use of paint on radiator cores is prohibited.

b. Vehicles should be inspected *before* being washed, because of the greater ease in detecting loose parts and assemblies, broken dust films being the best evidence of looseness. Scheduled lubrication should be performed *after* washing so that any water or dirt which has entered bearing surfaces may be forced out by the pressure of the new lubricant.

■ 44. CARE OF TOOLS AND EQUIPMENT.—The driver is responsible that tools, spare parts, pioneer equipment, chains, traction devices, towing cables, paulins, and equipment furnished with his vehicle are in their proper places, are clean, and are in condition at all times for immediate use. Any equipment which becomes unserviceable should be repaired or replaced immediately. Shortages or unserviceable equipment should be reported to the chief of section or other designated individual.

■ 45. CARE OF TIRES.—*a.* The chief responsibility of the driver in caring for tires is that of proper inflation. Tires should be inflated to recommended pressures and the pressure checked daily with a reliable gage. Air pressure cannot be determined satisfactorily by looking at the tire.

*b.* In general, tires should be removed from their wheels at least yearly to permit conditioning of wheel rim surfaces. Rim surfaces should be cleaned and covered with a protective coating to prevent rust. Wheels, including spares, should be changed periodically to secure uniform tire wear and to maintain resiliency in the spare tires.

*c.* When mounting tires on a motor vehicle, particular attention should be paid to sizes. In general, tires should be mounted in pairs. That is, tires of equal outside diameter should be mounted on the front wheels and those of equal outside diameter on the rear wheels of a 4 x 2 vehicle. However, on an all-wheel-drive vehicle without a center differential or other compensating device, all tires should have the same outside diameter. In order to maintain this condition after tires become worn, it may be necessary to transfer tires from one vehicle to another.

*d.* When mounting dual tires, the worn tire should be placed on the inside. Tires differing more than one-half inch in outside diameters should not be mounted on the same wheel or on the same axle.

*e.* Drivers should be constantly alert to detect evidence of excessive or unusual tire wear. The most common causes of excessive tire wear are—

(1) Improper inflation, including under and over inflation and bleeding.

(2) Poor driving, including fast starting and stopping and improper use of brakes.

(3) Rocks or other foreign material wedged between dual tires.

(4) Misalignment.

(5) Overloading and improper loading.

(6) Improper sizing of tires (different sized tires on the same axle, etc.).

■ 46. CARE OF STORAGE BATTERY.—The motor vehicle driver should have a general knowledge of the functioning of a storage battery. He should know the correct ammeter reading for proper functioning of the generator and the general procedure to be followed when any abnormal reading is observed. He should know how to use the storage battery so as to prolong its period of usefulness. The following care by the driver should be routine:

*a.* Keep battery terminal connections clean and tight. Remove and clean corroded connections, using a weak alkaline solution if available. Dry the connections, apply a thin coating of vaseline or soft grease, replace and tighten the connections. Corroded terminal connections reduce storage battery efficiency and overload the generator.

*b.* Keep the battery clean and and securely clamped in the battery carrier.

*c.* Inspect the height of the battery electrolyte each week during summer and each two weeks during winter seasons. If the electrolyte is below the prescribed level, report the fact to the chief of section or other designated individual.

*d.* Report any unusual performance or battery condition immediately.

■ 47. DUTIES DURING SCHEDULED MAINTENANCE AND TECHNICAL INSPECTIONS.—*a.* Before his vehicle is submitted for scheduled maintenance or technical inspection, the driver should correct such mechanical defects as are within the limits of his ability and the tools and equipment provided for his use. The vehicle should not be cleaned unless it is excessively dirty, since the dust film aids the mechanics in detecting defects.

*b.* The driver should report known mechanical defects which he is not authorized to correct and accompany his vehicle while it is undergoing scheduled maintenance or technical inspection in order to further his knowledge of the mechanical condition of the vehicle and to permit the motor officer, or his representative, to point out results of improper operation or vehicle abuse and take proper corrective action.

■ 48. REPORTS.—*a.* Driver's reports generally applicable to all arms and services operating and maintaining motor vehicles are (AR 850-15)—

(1) Driver's Report—Accident, Motor Transportation (Standard Form No. 26).

(2) Driver's Trip Ticket and Performance Record (W. D., Q. M. C. Form No. 237).

*b.* In case of injury to person or property, the driver of a motor vehicle will stop the vehicle and render such assistance as may be needed, complying with State and local regulations relative to reporting accidents. He will fill out immediately at the scene of the accident Standard Form No. 26 and deliver it to his commanding officer immediately upon return to his station. This must be done in every case regardless of how trivial the accident may appear to be or whether Government property or personnel only is injured (AR 850-15). Proper use of the accident report form protects the careful driver in that it presents data secured immediately after the occurrence of the accident and permits completion of an investigation before facts become distorted.

*c.* A properly completed driver's trip ticket furnishes valuable data for organization maintenance records as well as a written report of performance defects and emergency repairs effected. The report of defects protects the driver and puts the responsibility for repair on the shop maintenance personnel. When driver's trip tickets are not used, an oral report should be made by the driver.

■ 49. EMERGENCY ROADSIDE REPAIRS.—*a.* Emergency roadside repairs are limited by the ability of the driver and the tools, supplies, and equipment available for his use.

*b.* In performing emergency repairs, the driver should not force any part nor attempt the repair unless he is reasonably certain that he has diagnosed the trouble correctly. Tampering with mechanisms is prohibited. At the first opportunity after an emergency repair has been effected, the driver should report the fact to his chief of section or other designated individual in order that proper action may be taken. The following are examples of emergency roadside

repairs which a driver should be permitted to perform after he has received proper training:

- (1) Remove, clean, reset, and install spark plugs.
- (2) Adjust fan belt.
- (3) Remove, blow out, and install gas lines.
- (4) Tighten nuts and/or cap screws around leaky gaskets.
- (5) Tape leaks in gas or oil lines and tighten connections.
- (6) Drain and clean the sediment bowl of the carburetor or fuel pump.
- (7) Tape electrical lines.
- (8) Plug leaks in the cooling system and tighten water-pump connections.
- (9) Straighten tie rods and steering linkage.
- (10) Loosen tight brakes.

## SECTION V

### EXAMINATION AND OPERATOR'S PERMIT

■ 50. EXAMINATION (AR 850-15).—Motor vehicle operator's permits will be issued only to individuals who have satisfactorily passed an examination conducted by a qualified commissioned officer covering the following subjects:

*a. Mechanical.*—Nomenclature and functions of major units of the motor vehicle.

*b. Operation.*—(1) Actual driving of the vehicle, involving use of controls, reversing, and parking under usual conditions of traffic and terrain.

(2) Traffic regulations, road procedure, safety precautions, speed limits, and vehicle abuse.

*c. Maintenance.*—First echelon (vehicle operator's) maintenance.

■ 51. OPERATOR'S PERMIT (AR 850-15).—*a.* W. D., Q. M. C. Form No. 228 (U. S. Army Motor Vehicle Operator's Permit) will be issued by commanding officers to all enlisted and civilian operators of Regular Army motor vehicles.

*b.* Possession of a motor vehicle operator's permit should be a guarantee that the individual is a safe driver. Accordingly the permit will be immediately revoked when an accident or other cause so warrants.

## CHAPTER 3

## MARCHES

	Paragraphs
SECTION I. General .....	52- 58
II. Types .....	59- 62
III. March technique.....	63- 65
IV. Organization for a march.....	66- 68
V. Logistics.....	69- 78
VI. Orders .....	79- 84
VII. Reconnaissance .....	85- 94
VIII. Defense against aircraft and mecha- nized forces .....	95- 96
IX. Execution of the march.....	97-113
X. Traffic control, restrictions, and circu- lation .....	114-117

## SECTION I

## GENERAL

■ 52. SCOPE.—The treatment of motor marches in this manual is confined principally to those executed in the combat zone. The discussion of the tactical employment of troops during and at the termination of a motor march is confined to defensive measures necessary to combat attacks by aircraft and hostile mechanized forces. Necessary modifications of march technique to cover movements in rear of the combat zone and peacetime marches are indicated.

■ 53. KNOWLEDGE NECESSARY TO OFFICERS.—A knowledge of movement by motors has become a responsibility of officers of every grade and arm. This knowledge embraces, among other things, use of road nets, staff plans, reconnaissance, issuance of orders, march technique, defense against attack by aircraft or mechanized forces, and administrative measures.

■ 54. CHARACTERISTICS OF MOTOR MOVEMENTS.—The outstanding characteristics of modern motor movements are the tremendous distances over which immense tonnages may be transported and the great potential flexibility in the rates of march employed. The principal difficulties which such moves entail are those of control, communication, concealment, length of columns, vulnerability to attack, defense, and

dependence on technically correct supply and maintenance systems.

■ 55. **INFLUENCE OF AIR AND MECHANIZED FORCES.**—The vulnerability of large-scale motor movements to aviation and the secrecy usually desired in such moves are frequently deciding factors in the selection of a suitable method of march. The threat of attack by hostile mechanized forces is to a lesser extent responsible for the march methods adopted. Since no one method of marching will suffice to combat such threats, several types, which are discussed in section II, have been evolved.

■ 56. **MARCH DISCIPLINE AND TRAINING.**—The very nature of modern motor movements, particularly the difficulties of control and communication, the sudden changes in orders, and the high rate of movement, as well as the amount of discretion and responsibility which must be left to subordinate commanders and even drivers, makes necessary a high degree of march discipline and training.

■ 57. **PRINCIPAL ELEMENTS OF MOTOR MOVEMENTS.**—Some or all of the following elements may be essential in the successful execution of motor movements:

a. In the selection of routes, avoiding stream lines, mountain passes, and similar terrain features which may be classified as natural bottle necks.

b. Provision of suitable detachments of engineer ponton trains and pioneer troops.

c. Provision of a suitable escort to protect against attack by aircraft or mechanized forces.

d. Adoption of a type of marching giving sufficient dispersion to avoid offering a profitable target whenever both air and ground escorts are insufficient to give air and ground superiority.

e. Use of multiple columns in marching.

f. Use of the necessary control personnel and plans to permit rapid rerouting of columns in case of emergency.

g. Use of concealed bivouac or assembly areas in which to commence and terminate each movement, utilizing the minimum number of halts.

h. Use of dispersed small bivouac or assembly areas.

*i.* Prevention of massing of vehicles, particularly at the initial point, during halts, and at the entrance to bivouac or assembly areas.

*j.* Measurement of distance in *time* rather than *space* in all staff planning.

*k.* Thorough ground and air reconnaissance, to the extent time permits, of contemplated routes to include search for possible mining of roads and bridges.

*l.* Provision of suitable radio equipment.

*m.* Provision of sufficient motor maintenance facilities.

■ 58. DEFINITIONS.—*a.* *Accordion action (whip).*—The variation of distances and speeds of vehicles within a column during movement.

*b.* *Block control.*—That system of traffic control which employs the use of a suitable number of military police or other personnel for the purpose of blocking off all interfering traffic.

*c.* *Clean-up party.*—Personnel under command of an officer who remain in camp after the departure of the main body to make the final police of camp.

*d.* *Column.*—One or more march units, or serials, under one march commander, using the same route.

*e.* *Commander of troops.*—The officer in command of the unit being transported. He may be also the march or convoy commander.

*f.* *Control car.*—A car carrying an officer, normally the executive, which precedes a column and maintains the rate of march.

*g.* *Convoy.*—Any group of motor vehicles organized to operate as a military unit in contradistinction to organically motorized tactical units or service trains.

*h.* *Convoy commander.*—The officer in charge of motor transportation and operating personnel of a convoy.

*i.* *Distance.*—The space from the rear of one vehicle (including towed load, if any) to the front of the next vehicle in column; or the space from the rear element of a leading unit to the leading element of the following unit.

*j.* *Double staggered columns.*—A double column of vehicles moving in the same direction on two lanes of a road, with the



vehicles of one column driving opposite the spaces between vehicles of the other column.

*k. Entrucking and detrucking points.*—The points where the head of a truck column halts for the entrucking or detrucking of troops or supplies.

*l. Entrucking groups.*—Troops, matériel, or supplies properly disposed for loading at an entrucking point.

*m. Escort.*—Troops detailed to prevent interference with a motor movement, by hostile air forces, mechanized or other ground forces, or civilian traffic.

*n. Guard.*—An individual, preferably a noncommissioned officer, placed at an extremely sensitive point, such as a railroad crossing or a turn into or off a main road, to control traffic.

*o. Guide.*—An individual who leads or guides a unit or vehicle over a predetermined route or into a selected bivouac area.

*p. Initial point (IP).*—A point at which a moving column is formed by the successive arrival thereat of the various subdivisions of the column.

*q. March discipline.*—That quality acquired through training and experience in marching which insures adequate march control; care of equipment; obedience to march restrictions; proper conduct and performance of duty by individuals; correct formations, distances, and speeds; and effective use of cover.

*r. March graph.*—A graphical presentation of a march used in planning and controlling marches and in preparing and checking march tables.

*s. March order.*—An order issued by a commander to his subordinates covering the details of the movement.

*t. March report.*—An official report submitted at the end of a march.

*u. March table.*—A combined location and movement schedule for a march.

*v. March unit.*—A group of motor vehicles placed under a single commander to facilitate column control.

*w. Marker.*—An individual, or distinctive object, placed at a critical location to indicate a position, direction, procedure, or obstacle.

*x. Mobility.*—Facility of, or capacity for, movement.

*y. Pioneer work.*—That work executed to eliminate or reduce obstacles which are likely to delay the column.

*z. Quartering party.*—Personnel, under the command of an officer, who precede the main body on the march and lay out the camp or make arrangements for shelter of the troops.

*aa. Rate.*—The average number of miles per hour made by a column over a given period of time. It includes short halts for maintenance and change of drivers.

*ab. Regulating point.*—An easily recognizable point where the incoming motor transport column is separated into detachments for entrucking or detrucking purposes.

*ac. Release point.*—The point where a march column formation is broken up and units are turned over to their commanders.

*ad. Road block.*—An obstacle placed on a road to stop or prevent traffic on the road.

*ae. Road capacity.*—The practicable maximum number of vehicles that can pass over a given road at a given rate within a given time.

*af. Road space.*—The measurable length of a column on the road from the head to the tail.

*ag. Road time.*—The total time a marching unit occupies a given section of road.

*ah. Route marking party.*—Personnel used to mark the route and to control traffic at congested points along the selected route of march. The party precedes the march column and is usually commanded by an officer.

*ai. Serial.*—One or more march units, preferably with the same march characteristics, placed under one commander for march purposes.

*aj. Shuttling.*—A system for moving troops or supplies when more than one trip is required to complete the move.

*ak. Speed.*—A definite momentary quantity, referring to an individual vehicle, measured in miles per hour.

*al. Strip map.*—A section or strip, cut or reproduced from a map, showing diagrammatically a definite route to be followed or area to be crossed.

*am. Time distance.*—The distance to a point measured in time. It is found by dividing the road distance to the point by the rate of march.

*an. Time interval.*—The interval of time between march units or serials, usually measured from head to head.

*ao. Time length.*—The time required for a column to pass a given point.

*ap. Trail car.*—A car which follows the tail of a column and which transports an officer whose duty it is to transmit information to the march commander concerning the location of the trail car and the number and status of disabled vehicles.

## SECTION II

### TYPES

■ 59. INFILTRATION (TYPE I).—Careful planning, a high state of training, and continuous control are necessary for the successful execution of a movement by this method.

*a. Description.*—Vehicles are dispatched at irregular intervals from concealed bivouacs, either singly or a few at a time over a marked route leading to another concealed bivouac or to an assembly area. The rate of flow should approximate the traffic density in the general area where the movement is being made. The picture from the air should be one of normal routine traffic.

*b. Advantages.*—This type of march provides, during daylight, the most protection from a hostile air force. It presents no profitable targets for mass aerial attack or artillery fire. It provides a fair degree of secrecy, because of the small number of vehicles seen by an air observer at any one time. It offers the same advantages during moves made at night. Cross traffic offers no problem.

*c. Disadvantages.*—Although the rate of march is normal, the column length is longer and a longer time is required to complete the movement. On dark nights when moving in areas where lights are forbidden, the route must be marked with luminous markers, since the distance between vehicles precludes watching the vehicle ahead. Time should be available for very careful marking of the route, as well as for

necessary road blocking, to prevent vehicles going astray. Control difficulties increase with the obscureness of the route.

*d. Uses.*—This is a satisfactory type of movement when secrecy is desired and *when there is no possibility of troops entering combat before completion of the march.*

■ 60. CLOSE COLUMN (TYPE II).—*a. Description.*—In this type of march the maximum capacity of the route is utilized. The column may or may not be divided into march units of 25 to 50 vehicles. When so divided, usually companies, troops, or batteries, and exceptionally battalions, are designated as march units. Drivers maintain minimum safe driving distances from the vehicles ahead. These distances vary with the speed. When used, march units may maintain sufficient time interval or distance from the unit ahead to stabilize speed and permit smooth marching. Where a two-, three-, or four-lane road is available, double staggered columns of this type may be employed.

*b. Advantages.*—The time length of the column in this case is as short as it is possible to make it, consistent with high speeds. Control is the best obtainable. Intercolumn communication is easier. The column is on the road the shortest possible time. This method also makes the maximum use of road capacity and friendly aircraft protection. It is valuable for short moves which can be completed before enemy air units have time to strike.

*c. Disadvantages.*—This method does not provide passive protection from aerial observation and attack. Strength and type of organization are apparent to aerial observation. In many cases, the vehicles arrive faster than they can be employed tactically. When this type of column possesses sufficient time length, it also provides profitable targets for mechanized forces.

*d. Uses.*—This type of movement is applicable, in forward areas, to moves made with an escort of friendly aviation. It is especially adapted to large-scale high-speed movement in rear areas where time and distance factors preclude the chances of discovery and attack. It is also useful during night moves. When time has been insufficient for proper route marking, march units and vehicles may be closed up and the speed reduced. The drivers are close enough to the

vehicles ahead to follow hooded tail lights. It is useful, during either daylight or darkness, for moving small organizations (less than 40 to 50 vehicles) which do not present profitable targets, where secrecy is not essential, and where the number of available markers is limited.

■ 61. OPEN COLUMN (TYPE III).—*a. Description.*—This method is a compromise between types I and II (pars. 59 and 60). Distances between vehicles, however, are increased; usually a minimum of 100 yards is prescribed. Increased distances between march units may also be employed.

*b. Advantages.*—This formation does not present a profitable target for massed aerial attack or for attack by mechanized forces. No two vehicles will come simultaneously under the fire of hostile machine guns or within the bursting radius of enemy bombs. Hence it forces hostile aircraft to aim bombs. It gives sufficient dispersion to provide secrecy from flares during night marches without lights. As to column time length, this is a compromise between the other two types of marching. The same comment is applicable to control, communication, and time on the road. Because of the distance between march units, it is easier to direct units to alternate routes in case of emergency.

*c. Disadvantages.*—No secrecy is possible in moves of this type during daylight. Some losses will be suffered during aerial and mechanized attacks. The time length of the column makes it slower than a closed column.

*d. Uses.*—When moves must be made during combat in broad daylight, without air pursuit escort, and when time is so important that lack of secrecy and reasonable losses from attack are acceptable, this method is applicable. This formation offers reasonable protection coupled with speed on any small move in which secrecy is not essential. It may be used to good advantage on moonlight nights, since the dispersion is sufficient to prevent simultaneous bombing of two or more vehicles. On dark nights this amount of dispersion provides secrecy, since a flare will pick up only one or two vehicles. In general this type is used where combat is imminent.

■ 62. OTHER TYPES.—Many other terms are in use to describe march methods, such as combat team marching and

shuttling. The types of marching already described are equally applicable to these various specific examples of marching. The same methods apply to marching when out of range of enemy aviation and mechanized forces. Similarly, all three methods can be successfully applied to peacetime marches. In times of peace and in marching in combat rear areas, however, the selection of type is determined by other factors, such as the density of population of the march area, road net, ruggedness of terrain, weight of loads, and training of drivers. It should not be forgotten that, for supply convoy work in rear areas with trained and responsible personnel, the individual dispatch of vehicles as practiced in commercial fleets is often the most efficient method.

### SECTION III

#### MARCH TECHNIQUE

■ 63. INFILTRATION (point to point).—*a. Object.*—The objective sought is the movement of a group of vehicles from one concealed area to another, presenting the picture of routine traffic en route.

*b. March unit.*—The individual vehicle becomes the march unit.

*c. Formation for the march.*—The formation for the march resolves itself into a problem of carefully coordinated dispatching of vehicles from all the small (battalion) bivouac areas which feed each route used. Vehicles should be dispatched singly or in small groups at irregular intervals. The optimum rate of flow to afford secrecy should approximate five vehicles per mile.

*d. Speeds and distances between vehicles.*—These are under the control of the drivers, each of whom is an individual march unit commander in this case. To prevent undue racing and bunching up, a running speed and a maximum speed should be prescribed separately for light, medium, and heavy vehicles. A maximum speed of 10 miles per hour faster than the running speed furnishes ample latitude under normal conditions.

*e. March control.*—March control is effected by traffic control of the route or routes of march. If the march is of

considerable length, the route should be subdivided into divisions, over each of which route markers are posted and control points established. Over routes where other traffic is moving, the route markers should wear prominent identifying brassards. It may be possible to use wooden or metal route markers to supplant and reduce marker personnel. Divisions of the route should be interconnected by telephone or radio. Officers should be stationed at critical control points. Motorcycle messenger service should be available at these points. Flags should be used by control personnel to signal drivers to slow down, stop, etc. At night when lights are not permitted, luminous markers must be employed. *Drivers should be issued road or strip maps or map substitutes. Control point personnel must be prepared to divert traffic to alternative routes in case of bombing of bridges, severe shelling, or similar reasons. Blocking of cross traffic may become necessary.*

*f. Bivouac or assembly areas.*—Vehicles of different organizations may arrive at their destination (bivouac or assembly area) somewhat intermingled after a march of this type. Whether intended or not, certain vehicles will arrive late. It is extremely important, therefore, that sufficient route markers bearing large organizational markers (fig. 4) be posted at the end of the route. Drivers may thus readily find their own bivouac areas. Otherwise, massing of vehicles will result, nullifying all previous efforts to obtain secrecy of movement.

■ 64. CLOSE COLUMN.—*a. Object.*—The object sought is the utilization of the march route at its maximum capacity while moving at relatively high rates of march.

*b. Mechanics of movement of a column of vehicles.*—(1) If a motor column paced by a vehicle setting a constant speed is moved over a level road, the whole column will move at a constant speed provided each driver maintains a fixed distance from the vehicle ahead. Practically there will be no variation in the length of the column and no accordion action.

(2) A column of any length, however, will cover simultaneously many radically different stretches of road and incidents of terrain which cannot all be traversed at the

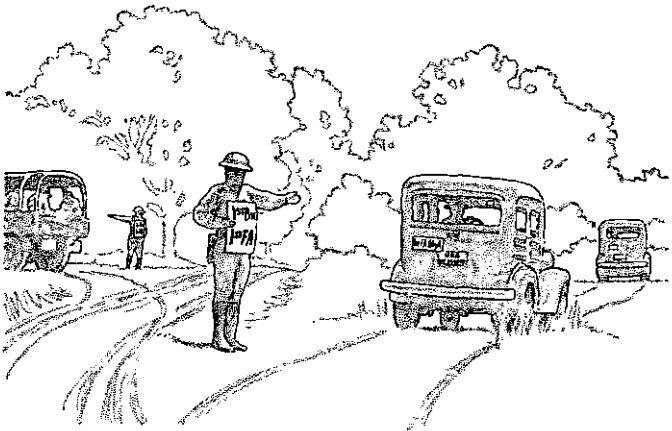

FIGURE 4.—Markers at a bivouac area.

same speed, such as hills, changes in road surface, sharp curves, dust clouds, mud, and slippery roads. The result is that different parts of the column are moving simultaneously at different speeds; for example, a column passing over a hill. Vehicles ascending a fairly steep slope lose speed, shift gears, and gradually ascend the hill. As each vehicle reaches the top, it resumes its speed in order to close on the vehicle ahead. A gap occurs in the column on the far side of the hill and the column has elongated. Vehicles close up at the foot of the hill. If the hill is short, this accordion action passes back through the column without causing much trouble. If the hill or obstacle is long, a very serious condition results; on the far side of the hill a large gap occurs sparsely filled with vehicles racing to catch up and resume their places in column, while short of the hill a long and constantly increasing mass of vehicles comes to a dead stop. All methods of column marching are attempts to alleviate or localize such violent accordion action caused by unavoidable incidents of terrain.

*c. Fixed-distance march method.*—In this case, fixed distances are prescribed between vehicles and between march units. This method does not provide sufficient column flex-



ibility to permit it to close freely to absorb delays and to react freely to recover from them. To a lesser extent the same criticism results from attempts to prescribe fixed speeds for the heads of march units. The column is still too inflexible. The result is excessive accordion action and elongation of the column.

*d. "Follow me" march method.*—In this method a speed is prescribed for the leading vehicle of the column. No march units are designated. Instead, each driver throughout the column is ordered to keep closed on the vehicle ahead to what in his judgment is the limit of safety. A maximum speed limit for vehicles in regaining lost distance is also prescribed.

*e. Time-control march method.*—Essential elements of this method are as follows:

(1) *March graph.*—For each march route a graph is constructed. It may be based on actual reconnaissance (time permitting). Lacking time for reconnaissance the graph is constructed by estimation, using a road map and knowledge of local road conditions. In this manner, rates of march suitable to each section of the route are determined. (See par. 75.)

(2) *Control car.*—An officer experienced in marching, other than the column commander, is designated to regulate column speed. He selects a vehicle to lead the column which has performance characteristics of the slower vehicles in the column. He sets a column speed which will produce a rate of march in conformity with the march graph. If, however, weather or other conditions arise which prove that the rate of march indicated on the graph is not feasible, he does not hesitate to alter it accordingly. His vehicle is designated the control car.

(3) *March units.*—March units must be designated for each column. The company, troop, or battery (25 to 50 vehicles), or exceptionally the battalion, is the most satisfactory march unit. The use of march units commanded by officers moving against time instead of distance makes possible an intelligent stabilization of speed throughout the column. The additional advantages of the employment of march units are less wear and tear on transport, fewer acci-

dents, less driver fatigue, better control of units, smoother marching, and greater rate of march.

(4) *Time intervals.*—Time intervals are prescribed between march units. They are usually measured from the head of one unit to the head of the following unit. Thus the march unit commander is concerned only with regulating his time behind the control car, even though the march unit ahead is out of sight. Time intervals normally are so calculated as to allow from one-half to one minute between the tail of one march unit and the head of the following march unit. For instance, a time interval of 4 minutes would be required to allow 1 minute from the tail of one march unit of 30 vehicles to the head of the following march unit ( $30 \times 0.1 + 1.0$  minute) (par. 70b). Under certain road conditions or with inexperienced drivers, the time allowance from the tail of one march unit to the head of another may well be increased to 2 or 3 minutes. *The ideal way to have the column move is to so adjust the time interval between march units that each vehicle will pass over any given piece of road at the same speed as the control car.* Every 15 or 20 minutes the officer riding the control car notes the time as he approaches a marker. The marker may then be informed of the correct time by having the control car officer call the time in passing or toss to the marker a piece of paper or small blackboard on which the time is written. The marker then informs march unit commanders of the time as they pass. Units possessing proper radio equipment may require the control car to announce by radio its passage of markers or prominent landmarks. The march unit commanders, knowing the time interval between march units as well as their position in column, may glance at these boards and tell at all times how they are running with respect to the control car. This permits the march unit commander considerable latitude in stabilizing the speed of his unit.

(5) *Intervehicular distance.*—In order to permit maximum flexing of the column, no rigid distances should be set between vehicles. However, minimum safe distances are prescribed. They vary with the vehicle speed, being a function of braking distance. A rule of thumb follows: *Under*

*favorable operating conditions the minimum safe driving distance, in yards, is approximately twice the speedometer reading.*

(6) *Column commander.*—Once the column is in motion it is very difficult for the column commander to exercise command. It is desirable that he be near the head of the column to make decisions as different situations arise. One or more of the following aids may be used to exercise command: motorcycle messengers, radio, aircraft if available, and control points.

■ 65. *OPEN COLUMN.*—The technique described above (par. 64e) applies with equal force to open-column marching, since the only difference is the increased distances between march units and between vehicles. These increased distances in themselves make for smoother and easier marching. Time interval between the tail of one march unit and the head of the following march unit is usually set at from 2 to 5 minutes. Minimum intervehicular distances usually vary from 100 yards to one-tenth of a mile. The primary purpose of these increased distances is to minimize possible losses from aerial or mechanized attacks in this type of marching.

#### SECTION IV

#### ORGANIZATION FOR A MARCH

■ 66. *COMMAND.*—*a. Organic motorized tactical units.*—Movements of organic motorized tactical units are made under the direction and supervision of unit commanders.

*b. Organic motorized trains.*—Organic motorized trains carrying equipment and supplies likewise move under the direction and supervision of the train commander who is the senior officer or noncommissioned officer present in the units comprising the train.

*c. Nonorganic vehicles.*—Movements of troops in vehicles that are not a part of their unit equipment are usually commanded by the senior troop commander present. His staff acts as a convoy staff. The motor-transport officer acts as a member of the commander's technical staff. However, if the troop movement is being handled by the staff of a

higher headquarters as a part of a large move, the arrangement is usually as follows:

(1) The transportation units are organized, staffed, and commanded on orders issued by the higher headquarters.

(2) The convoy commander moves his vehicles to previously planned entrucking points. He is responsible for the technical operation of the transportation and the movement of the column. Orders to the convoy-operating personnel will be given only by the convoy commander and his assistants.

(3) The commander of troops will exercise no control over the operations of the column except in a tactical emergency. He is responsible for the administration and discipline of the troops transported.

■ 67. CLASSIFICATION OF CONVOYS.—Convoys may be classified as follows:

a. According to their loads, they are known as *troop or supply convoys*.

b. According to their type of vehicles, they are classified as *light, medium, or heavy convoys*.

c. According to the service of their vehicles, they may be classified as—

(1) *Train convoys* made up from trains.

(2) *Provisional convoys* made up from either military vehicles not ordinarily formed as such, or vehicles from nonmilitary sources.

■ 68. ORGANIZATION OF MOTOR MOVEMENTS.—In motor movements of both tactical units and convoys in the combat zone, the organization into columns, serials, and march units is determined by the mission, the tactical situation, the road net, and the equipment of the units concerned. Logistical considerations, for instance, may dictate the separation of tactical units into speed columns and heavy columns.

a. *Type of march*.—The type of march to suit the tactical situation may affect the organization of the movement. For instance, secrecy may dictate a movement by infiltration where identity of units is sacrificed.

b. *Action imminent*.—Whenever a move terminates in areas where action is imminent, tactical organization takes precedence over all other considerations. Here the cohe-

sion and unity of action possible only to an organization knit together by association and arduous training becomes all important.

*c. Variations.*—With the many variations of march organization open to the staff planning the move, the final choice should be made only after a careful study of the particular situation.

*d. Details.*—The details given below must be considered in planning a motor movement. Depending on the conditions under which any particular movement is made, it may be practicable to combine one or more of the groups outlined.

(1) *Reconnaissance party.*—Where practicable, reconnaissance prior to any motor movement is advisable. The functions, equipment and formation of this group are considered in section VII.

(2) *Pioneer work.*—The necessary pioneer work in preparing the route is usually accomplished by engineer troops. Lacking these, this important work must be performed by the units making the march. The requirements for this work vary greatly. They are negligible when moving over primary highways but become extremely heavy when moving over routes recently in possession of the enemy. In any case an estimate must be made of the necessary personnel, tools, material, and time for elimination and reduction of obstacles. Pioneer work is covered in chapter 4.

(3) *Route marking.*—Proper route marking, especially if the infiltration type of march is employed, is important. Even though the primary highway signs, flags, and luminous markers have their proper uses, a certain amount of personnel is usually necessary for marking the route. The detail should be carefully organized and instructed. Their interrelation with personnel delegated by higher headquarters is covered in section III; their duties are covered in section VII.

(4) *Traffic control.*—To provide for such contingencies as bombing of bridges, artillery fire, and changes in orders, all of which necessitate rapid rerouting, a series of control points interconnected by communication may be necessary. Under other circumstances, traffic personnel such as military po-

lice and motorcycle messengers may be required to supplement the route marking detail.

(5) *Quartermaster party*.—The early dispatch of a quartermaster party is important. Its mission is to lay out the bivouac or assembly areas at the march destination and to guide units as they arrive at a selected release point to these exact areas. It also prepares a plan for suitable disposal of available anti-tank weapons for the antitank defense of the area, as well as similar provisions for the anti-aircraft defense. Suitable personnel for this party usually include an assistant S-3 and one other officer from the battalion staff, an agent or guide from each company or battery, and the necessary enlisted men, drivers, and mechanics. In moves of a division, regimental representatives only will be required.

(6) *Command and communication*.—(a) The exercise of command over a long, fast-moving motor column is difficult compared to that of columns composed of foot elements and animals. The sudden attacks to which it is subject and the destruction of bridges and roads all combine to make reliable communication agencies a necessity. When the tactical situation prohibits the use of radio, airplanes and motor messengers must be depended upon for transmission of orders. When the use of radio is permissible, provision should be made to make full advantage of it.

(b) A chain of control points connected by radio or commercial telephone or telegraph is often a necessity, particularly when infiltration moves are in progress. Traffic personnel may also be employed to assist in communication. Two command echelons should be organized. The forward echelon should consist of the column commander, part of his headquarters personnel, and representatives from each battalion or similar unit. In moves of a division, regimental representatives only would be required. The commander with his echelon is free to move where he chooses. Because of the length of the column, it is usually impossible for him to make passages of the column, and his echelon will usually be found near the head of the column. In certain situations he may move directly to the new assembly area. It is important that he be far enough to the front to render decisions as the situation requires.

(c) The second echelon will consist of the executive officer, the remainder of the headquarters staff not elsewhere employed, and representatives from each subordinate unit. The second echelon, in case of marches of the infiltration type, will at first supervise the dispatch of vehicles and later patrol a sufficient part of the route or routes to insure proper movement of vehicles. In movement of a column or columns the executive or his representatives will ride in control cars at the heads of columns, directing the speed and routes to be followed. This group is also responsible that the time the control car passes markers or prominent landmarks is made known to march unit commanders every 15 to 20 minutes, either by use of radio, time blackboards, or announcement by the marker by voice. Their other duties are to take charge of the arrangements for any unforeseen detouring, to take necessary action in case of mechanized or aircraft attack, to superintend the halting and refueling of the columns, and to enforce march discipline.

(7) *Motor maintenance.*—Maintenance of motor transportation is a vital function of command. Supplies, tools, and trained officers and mechanics must be available and must be properly distributed for the march. Their functions include inspection of vehicles prior to the start and at each halt. Details are covered in chapter 5.

(8) *Supply.*—The usual supply functions must be provided for, including gas and oil. Details are covered in section V.

(9) *Evacuation of bivouac areas and supervision of the tail of columns.*—The proper supervision of evacuation of bivouac areas and of the rear of moving columns must be delegated to specified officers and men, since the length and speed of columns prevent these functions from being executed by members of the column proper.

(a) *Clean-up party.*—Sufficient personnel to inspect bivouac areas and halt sites after they are vacated by the column and to correct and report any deficiencies must be provided. In peacetime where camp sites are leased, it would be the function of the officer with this party to complete the necessary paper work with the property owners.

(b) *Salvage of disabled vehicles.*—Another function of this group is the salvage of disabled vehicles. Salvage is covered in detail in section IV, chapter 5.

(c) After completing his duties at the bivouac areas, the officer in charge and his detail join the tail of the column or columns just ahead of the motor maintenance section. His car usually carries a significant flag or marker to indicate it is the last unit in the column. His duties then are the supervision of the picking up of markers, caution flags, etc.; the investigation of accidents en route; and the inspection of damage to roads and bridges in peacetime.

(10) *Escorts.*—Air and ground escorts to guard against air and mechanized attacks are provided for in the original plan. In the plans for antimechanized defense it may become necessary to reorganize all units present which are capable of antitank defense by splitting them up and inserting sections in column intervals.

## SECTION V

### LOGISTICS

■ 69. **GENERAL.**—Troops making a march are concerned first with the provisions of the warning order and the march order. Before these orders can be issued, careful planning by the staff is essential. Among other considerations, a thorough study of the logistics involved must be made to keep the march smooth and in step with a logical sequence of events and to insure that the requirements laid down for the troops are within the capabilities of personnel vehicles, and roads. The logistics found in this section are basic, apply to all motorized marches, and furnish the data necessary in planning a successful march.

■ 70. **ROAD SPACE AND TIME LENGTH.**—*a.* Road spaces for halted vehicles or those moving at rates of 5 miles per hour or less, day or night, are shown graphically in figure 5. At these rates, road spaces remain approximately constant. At rates above 5 miles per hour, road spaces vary with the rates and it is more practical to use time lengths.

*b.* Time lengths for close columns are, for all practical purposes, constant at rates over 5 miles per hour, since



greater speeds largely offset the increased distances between vehicles.

(1) The time length of a column of vehicles using the "follow me" march method may be computed by allowing .08 minute per vehicle. Thus a column of 300 vehicles would have a time length of  $300 \times .08$ , or 24 minutes.

(2) The time length of a column of vehicles using march units, marching at minimum safe driving distances, may be computed by allowing .08 minute per vehicle and .5

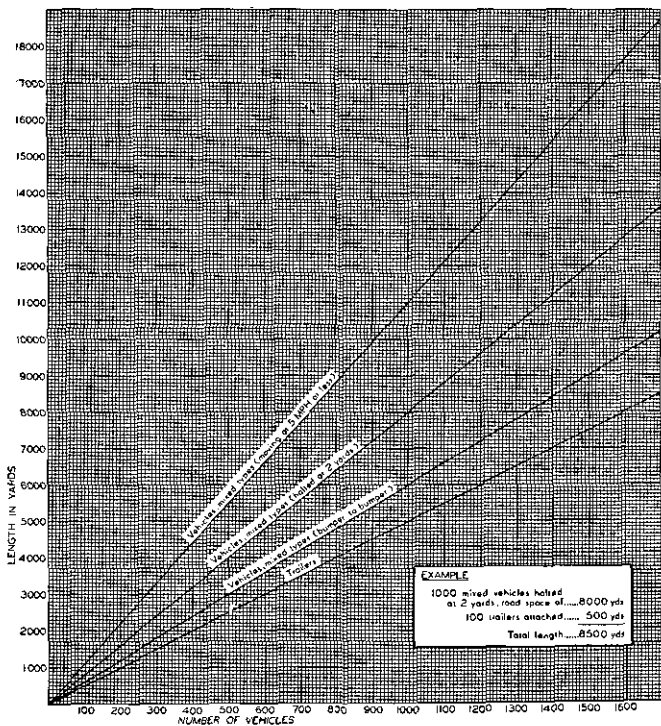

(Road space for vehicles moving at 5 m. p. h. or less is based on 5 yards' distance between vehicles.)

FIGURE 5.—A road space chart for rates up to 5 m. p. h.

minute between march units. Thus a column of 300 vehicles organized into 12 march units would have a time length of  $300 \times .08 + 12 \times .5 = 30$  minutes. For practical purposes, approximately the same result may be obtained by merely allowing .1 minute per vehicle. This automatically provides for the distance between march units. Thus 300 vehicles have a time length of  $300 \times .1 = 30$  minutes. The estimate of .1 minute per vehicle (600 vehicles per hour) must be reduced when adverse driving conditions are to be encountered. In case it is desired to figure time length for composite elements moving at rates under 5 miles per hour, figure 6 may be used. Knowing the road space of any unit, it is possible to arrive at the time length for its various rates of march.

■ 71. AVERAGE DAY'S MARCH AND RATES OF MARCH.—*a.* When tactical considerations do not interfere and during peacetime, the following may be used as a guide in planning an average day's march:

Preparation for the start of the convoy.....	1 hr.
(Includes time for breakfast, inspection of vehicles, and breaking camp.)	
Running time.....	7 to 8 hrs.
(Includes all halts except the noon halt.)	
Halt for lunch and refueling of vehicles...	1 hr.
(This halt is not considered in planning wartime marches.)	
Inspection and servicing of vehicles after arrival at camp.....	1 hr.

*b.* The rate of march to be adopted and the mileage to be expected for the day will vary according to conditions encountered en route. Average rates and lengths of marches for various types of motor columns under varied conditions are shown in the form following:

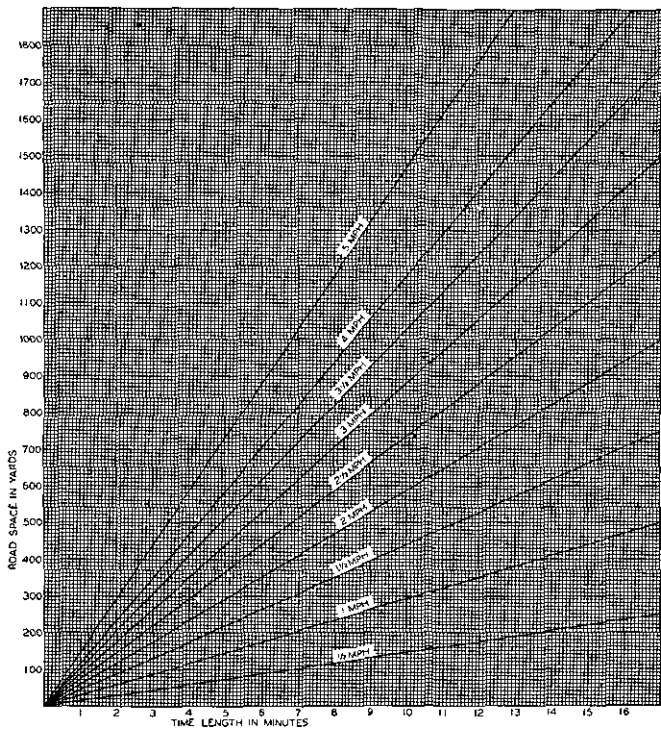

FIGURE 6.—A time length chart for rates up to 5 m. p. h.

## AVERAGE RATES AND APPROPRIATE LENGTHS OF MARCHES

Type of transport composing column (AR 850-15)	On primary roads			On hilly primary roads and secondary roads			Cross country <sup>a</sup>			Average day's march of a column (miles) <sup>c</sup>
	Day	Night		Day	Night		Day	Night		
		Lights	No lights		Lights	No lights		Lights <sup>b</sup>	No lights <sup>b</sup>	
Passenger vehicles and ½-ton trucks.....	30	30	5-15	25	25	5-15	10	3	3	40
Trucks, light.....	25	25	5-15	20	20	5-15	8	3	3	35
Trucks, medium.....	20	20	5-15	15	15	5-15	8	3	3	30
Trucks, heavy and extra heavy.....	20	20	5-15	15	15	5-15	8	3	3	25

<sup>a</sup> Cross-country rates assume use of traction devices when necessary. One-fourth to ½ hour is required to apply these.

<sup>b</sup> When routes have been previously reconnoitered these rates may be raised to 5 m. p. h.

<sup>c</sup> Forced marches of approximately twice the minimum distance may be made in a day. When trucks tow trailer loads in excess of one-half their gross weight, the rate will decrease approximately 5 m. p. h. on primary roads day and night with lights.

Above rates include 10-minute halts every 2 hours.

■ 72. **LOADING CAPACITIES.**—*a.* In computing the capacities of vehicles for carrying troops in a shuttle movement, normal loads of the vehicles must be deducted on one of the forward trips if the equipment of the organization is to be moved. Figure 7 gives the number of vehicles needed to transport personnel. These loading capacities are based principally on standard body dimensions. A check of actual capacities should be made before a march of any magnitude is planned.

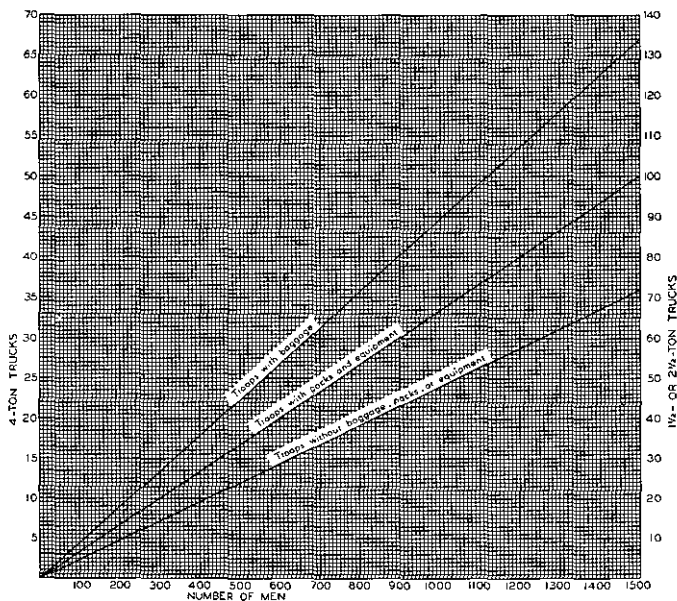

FIGURE 7.—Number of trucks required for troop movement by motor transport

*b.* Other loads frequently transported are as follows: Carts, all types (with loads), or 37-mm. guns: Four per light-cargo truck and six per 4-ton truck.

75-mm. artillery: One gun and one limber, or one caisson and one limber per 2½- to 4-ton truck.

Animals: Six horses or mules per 2½- to 4-ton truck, with special body.

■ 73. **LOADING TIME.**—Time required for loading and unloading:

	<i>To load</i>	<i>To unload</i>
Personnel only.....	15 minutes	10 minutes
Matériel or animals, or both, and personnel.....	30 minutes	15 minutes

After receipt of orders to move troops, the time required to place motor transport in condition to leave the location at which it receives its orders is as follows:

Trucks empty.....	15 minutes.
Trucks loaded with supplies.....	1 hour.

■ 74. **ROAD CAPACITIES AND DOUBLE STAGGERED COLUMNS.**—*a.*

In any movement of troops, one important factor which a commander is vitally interested in knowing is how long it will take to move his force from one point to another over a given road. This is particularly true of mass movements of troops into an area when the road net is limited. If the move is to be conducted in multiple columns, the road capacity of each route must be determined. Road capacity may be defined as the maximum practical number of vehicles that can pass over a given stretch of road at a given rate within a given time assuming that the road is empty of vehicles at the beginning and end of the period. Traffic bottlenecks and obstructions affect the maximum capacity of roads.

*b.* For the simultaneous movement of two columns of vehicles along a two-lane, one-way road, double staggered columns offer the best solution. This method permits the vehicles of each column to maintain safe driving distances within their respective columns. Usually no vehicle is driving abreast of any other vehicle. Both columns can maintain a fair rate of march, and obstructions that do not block more than one lane may be passed by permitting the vehicles in the obstructed column to momentarily pull over into the gap between vehicles of the unobstructed column until the obstacle is passed. In addition to the advantage of increasing the number of vehicles that can be moved over a road in a given time, double staggered columns have the advantage of reducing to one-half the time length of a column, thereby lessening interference with cross traffic and

permitting an increased use of the road by other traffic. It must be understood, however, that marching with double staggered columns has definite limitations and disadvantages. Where prolonged bottlenecks in the route occur frequently or when obstructions block more than one lane of the highway, the rate of march is decreased materially. The maximum march efficiency is obtained when both columns are made up of vehicles of the same march characteristics and the road is free of all obstructions. When obstructions occur in either lane, drivers will have difficulty in cutting in without loss of distance or reducing speed. Vehicles, except motorcycles, cannot move up and down the column.

c. The preceding discussion pertains only to roads reserved for military traffic. Although civilian traffic will seldom be a serious factor in war, frequently there will be times when military traffic is superimposed on other mixed traffic. In such a case, double staggered columns cannot be used unless the road is at least three or four lanes in width. Convoys will ordinarily then be limited to one column with distances between vehicles, march units, and serials great enough to accommodate existing traffic. To determine the road capacity available for military use under such circumstances, it is necessary to find out what mixed traffic to expect on the particular route and subtract it from the maximum road capacity. This must be done at various points along the highway wherever traffic conditions change. Cross traffic will operate to decrease the road capacity greatly, hence every effort should be made to avoid it by arranging for police escorts; by the use of underpasses, viaducts, and traffic circles; by avoiding congested areas; and by scheduling cross traffic to conform with halts.

■ 75. MARCH GRAPHS AND MARCH TABLES.—*a.* The field order for a march may be accompanied by a march table, particularly when the details of the march are not subject to change and can be foreseen. The march table affords a convenient means of transmitting to subordinates the many details pertaining to the march, the inclusion of which in the body of the field order would tend to complicate it or make it unduly lengthy.

b. Preparing a march graph is the simplest method of obtaining data required for a march table or order. The approximate location at any hour of the head or tail of each serial can be readily obtained from it, providing the march proceeds as scheduled. The march graph is prepared on cross-section paper, using one sheet for each route. The vertical scale to the left, with point of origin at the bottom, serves as a distance scale in miles and should show the relative locations along the route of towns, crossroads, or other terrain features which may be used as critical points. The horizontal scale serves as a time scale in hours, beginning at the left with the earliest hour at which the first serial may start the march.

c. A serial is represented on the graph by a horizontal line, drawn to scale, equal to its time length. This line is plotted opposite the place, on the vertical scale, from which the serial begins the march; that is, the initial point. The left of the line is plotted above the hour, on the horizontal scale, at which the serial begins the march. From this left end a line may be drawn at a slope representing the rate of March (at 15 m. p. h. the slope equals 15 miles on the vertical to 1 hour on the horizontal scale). This sloping line represents the march of the head of the column. Where this line intersects the horizontal line from a critical point along the route, we get a point, which, if projected on the time scale, will show the time the head arrives at such point. A line drawn from the right end of the horizontal line representing the time length of the serial and parallel to the line representing the head of the column will represent the tail of the serial, and time of clearances may be obtained as explained for the head of the serial.

d. If the hour at which a march must be completed is the only time factor known, the graph may be constructed starting with the tail of the column at the destination and working back to obtain the hour of starting for the head of the column. The graphs of all serials may be adjusted to allow for crossing columns or other interferences and the need for and the means of such adjustments may be visualized.



e. A march unit, after receiving a march table from higher headquarters, may find it necessary to prepare a detailed march table (page 62) or to construct a march graph suitable for column control. This graph shows halts, expected delays, and changes in the rate of march incident to road and traffic conditions. When preceded or followed by another serial, half the time interval between serials is available to each. This time boundary and the critical points prescribed in the march table limit the time zone in which the march of the serial may be plotted.

## FORM FOR DETAILED MARCH TABLE AND FOR RECONNAISSANCE OFFICER'S WORK SHEET

-----  
(Date)
 Organization-----  
 Place-----  
 Head to pass IP at-----  
 Time (distance) between units-----

Maps:

IP:

## ----- DETAILED MARCH TABLE (and work sheet for reconnaissance officers)

-----  
(Date)

(1) <sup>a</sup>	(2)	(3)	(4) <sup>a</sup>	(5) <sup>a</sup>	(6)	(7)	(8) <sup>b</sup>	(9) <sup>b</sup>	(10) <sup>a</sup>
Route or check points	Dis- tance from last point	Total miles from IP	Speed- ometer reading	Esti- mated road speed	Time from last point	Total time	Clock time	Head passes at indicated time after starting	Remarks
IP			M. p. h.	Min.	Hr. Min.	Hr. Min.	Hr. Min.		

<sup>a</sup> When used as a work sheet, Rcn. O. makes entries here while traveling.<sup>b</sup> Not used as a work sheet.

(Front side)

## Use as detailed march table

1. *IP*.—The *IP* is the initial or starting point of the convoy.
2. *Head of leading unit (serial) passes IP at* -----The clock time for the head of the first section (serial) is placed in the space provided.
3. *Time (distance) between units (serials)* -----A convoy may run with either a designated distance or a time interval between sections or serials. The designated time interval or distance is placed in the blank space as shown.
4. *Column 1*.—Cities, towns, crossroads, road junctions, and other readily recognizable check points along the route are placed in this column.
5. *Column 2*.—The distance from the preceding point is placed in this column.
6. *Column 3*.—The total distance from the *IP* is placed in this column.
7. *Column 4*.—This column is for the unit or serial commander. The speedometer reading at the *IP* is registered on the first line. The speedometer reading for the next point on the route can then be computed by adding to this speedometer reading the distance shown in column 2. This can be done in advance for each check point on the route.
8. *Column 5*.—The running speeds prescribed for the different stretches of road are placed in this column.
9. *Column 6*.—The time from the last preceding point is placed in this column.
10. *Column 7*.—This column shows the total number of minutes and hours from the starting point.
11. *Column 8*.—This column is for use of the unit or serial commander. The clock time when the head of a group passes the *IP* is entered, and then the hour when the head should pass other points on the route is obtained by adding to the starting hour the time shown in column 6.
12. *Column 9*.—In order to operate a column on a time schedule, control points, each of which the head of the serial should pass at a calculated time interval after starting from the *IP*, are designated. The time for passing these control points is placed in this column.
13. *Column 10*.—In this column data regarding the type and condition of the route, highway numbers, milestones, police escorts, refueling or halting points, grades, and all other information that could possibly be of value are recorded. Here also should be given data on how detours can be made if the road is found blocked or tactical necessity requires. The possibility of cross-country movement along all parts of the route should also be given here, as well as data showing how the convoy can best be reversed if that suddenly becomes necessary.

*Use as work sheet for reconnaissance officers*

(Omit columns 8 and 9)

*As he obtains data regarding a route, the reconnaissance officer uses columns 1, 4, 5, and 10. When convenient, columns 2, 3, 6, and 7 may be completed.*

*Note*.—Form used should be at least legal size paper (8 by 13 inches).

(Reverse side)

*f. Example.*—(1) The 1st Field Artillery Brigade has been directed to move the 1st Field Artillery (75-mm gun, truck-drawn, equipped with light trucks) and the 3d Field Artillery (155-mm howitzer, truck-drawn, equipped with medium trucks as prime movers) from their present locations, areas A and B to areas C and D (fig. 8), on September 15, 19—, under the following restrictions:

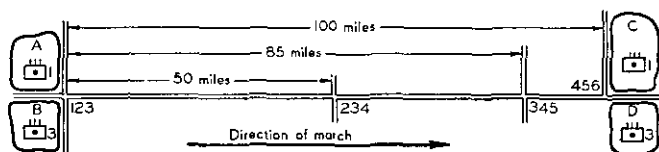

FIGURE 8.—Sketch of a day's march.

(a) The road CR 123-RJ 456 is available for the movement, but CR 234 is reserved for cross traffic except during the period 5:00 to 7:00 p. m.

(b) No daylight movement is permitted beyond CR 345, and movement after dark must be without lights on vehicles beyond that point.

(2) Figure 9 is the march graph used by the staff of the 1st Field Artillery Brigade in planning the march of the brigade. The march table (page 66) is issued as an annex to the march order. Figure 10 is the march graph prepared by the 3d Field Artillery for the control of its column.

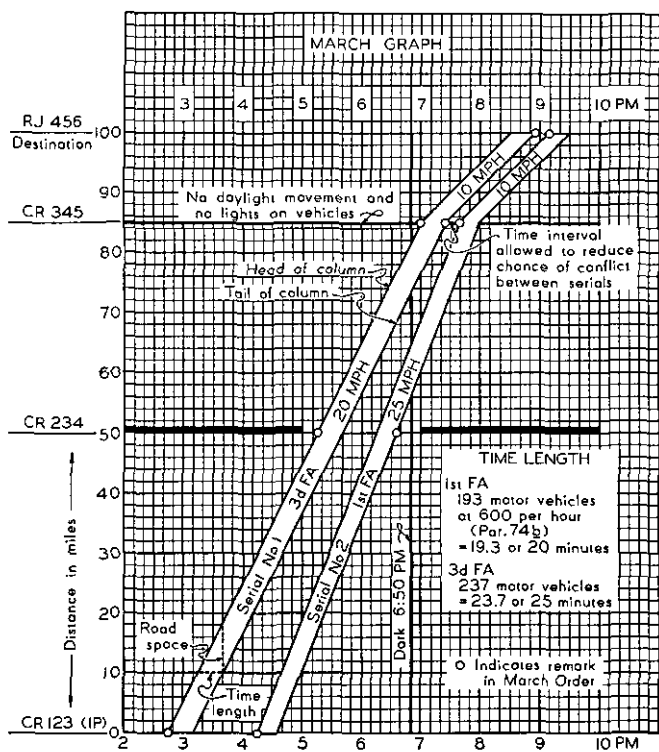

FIGURE 9.—March graph, 1st Field Artillery Brigade.

## MOTOR TRANSPORT

## Annex No. 1 to FO 7, 1st FA Brig

## MARCH TABLE

Sept. 15, 19—

Serial No.	Unit and commander	Present location	Route	Location by 10:00 p. m. Sept. 15	Remarks
1	3d FA....	Area B..	CR 123 to RJ 456.	Area D..	Head of column will pass CR 123 (IP) at 2:45 p. m., Sept. 15, and will not reach CR 234 prior to 5:05 p. m. or CR 345 prior to 6:55 p. m. Tail of column will pass CR 345 prior to 7:30 p. m. and RJ 456 prior to 9:00 p. m.
2	1st FA....	Area A..	CR 123 to RJ 456.	Area C..	Head of column will pass CR 123 (IP) at 4:15 p. m., Sept. 15, and will not reach CR 345 prior to 7:35 p. m. or RJ 456 prior to 9:05 p. m. Tail of column will pass CR 234 prior to 6:55 p. m.

By command of Brigadier General "1st FA Brig":

X  
Lt. Col., FA  
Ex

Official:  
Y  
Maj, FA  
S-3

## NOTES

1. Note that times given in the march table vary from those shown on the graph except for the IP. This is to allow for minor irregularities in rates and to offset the time consumed by halts for rest.

2. Where remarks are few, as in this case, they may be included in paragraph 3 of the march order.

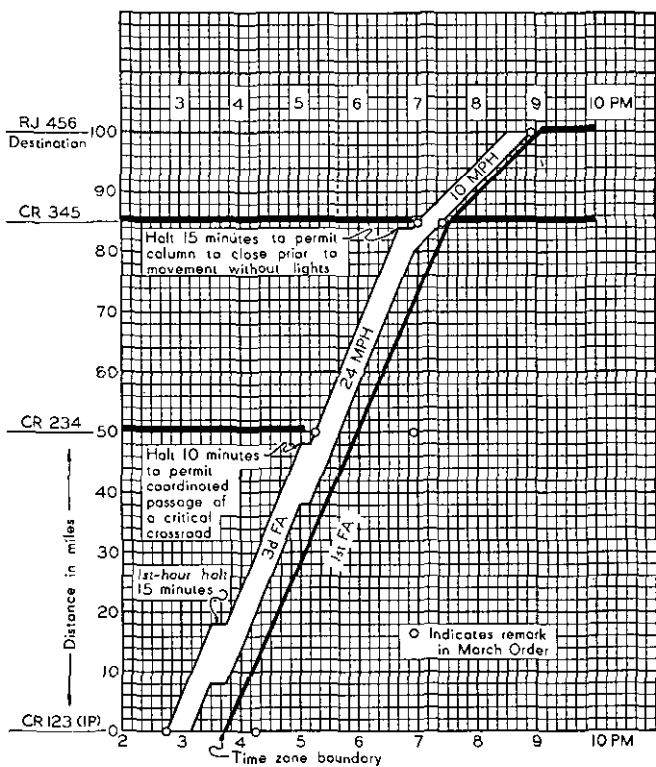

FIGURE 10.—March graph, 3d Field Artillery.

■ 76. ENTRUCKING AND DETRUCKING.—Prior plans should be made designating the regulating points, initial point, and entrucking and detrucking points, including the personnel to man them and the methods of entrucking and detrucking.

*a. Regulating points.*—A regulating point should be an easily recognizable terrain feature from which the distribution and movement of groups of vehicles to various entrucking and detrucking points are regulated. Designated personnel meet an incoming truck column at the regulating point and conduct the trucks of each of the groups into which the column splits to designated entrucking or detrucking points. After entrucking is accomplished, the personnel will guide these groups to the initial point in time for departure.

*b. Initial point (IP).*—An initial point is some readily recognizable terrain feature, such as a crossroad, located at the place where the separate units of a troop movement come together in passing out of an area. A staff officer of a unit being moved is stationed at the IP to insure that groups leave the area in the prescribed order. The place in column is designated for each unit, a time schedule is prepared, and the units should normally move past the IP in their proper places without halting.

*c. Entrucking and detrucking points.*—These points are well-defined terrain features located within or convenient to assembly areas of troops being moved. Detrucking points are located so as best to facilitate the clearing of the area by the truck column after detrucking is completed. When a highway is used by other traffic, detrucking should be done on a side road and the order should prescribe the method of moving out after detrucking is completed. In entrucking on narrow streets or roads, it is advisable to stop traffic and permit entrucking without traffic interferences.

*d. Entrucking and detrucking groups.*—(1) These groups consist of troops, matériel, and supplies entrucked (detrucked) at an entrucking (detrucking) point, and include the vehicles used. There should be as few entrucking and detrucking points as the situation permits. The number of entrucking or detrucking points used depends on how widely scattered the troops are when the motor transportation that is



to carry them arrives. Each movement is a different problem, and the methods of entrucking and detrucking must be worked out in advance if a movement is to go smoothly.

(2) Entrucking groups, including organically motorized groups that are to move as part of the column, are numbered serially in the order in which they are to clear the IP. The order in which entrucking groups clear is designated in the entrucking table by the convoy commander. The prime consideration is the order in which he desires his units to move or to arrive at their destination. The order in which the motor transport units re-form is a secondary consideration, although, whenever it is practicable, both this and tactical considerations should be coordinated. This usually can be done, and entrucking plans should accordingly preserve the initial order of vehicles whenever possible. Detrucking groups are numbered serially according to the order in which they pass the regulating point at the destination.

*e. Methods of entrucking.*—When trained and experienced troops are to be entrucked, it is sufficient to indicate to each subordinate unit the location of entrucking points and the number and capacity of the vehicles assigned to them. Counting off men into vehicle loads and designating trucks to carry them may be left to the troop officers. When entrucking must be accomplished under difficult conditions or with inexperienced troops, a method that insures rapid and orderly loading is to use assistant vehicle drivers as guides to lead the men to their proper trucks.

*f. Entrucking tables.*—Planning of moves is facilitated by the use of an entrucking table. The form (page 70) illustrates such a table, showing the essential provisions for the move. In case the movement is complex, a work sheet similar to that shown on page 71 will be of assistance in arriving at the data required for the entrucking table. These tables are only a means by which to plan a movement and should be tempered with the practical considerations involved.

ANNEX NO. ----- TO FIELD ORDERS NO -----

Maps:

Title  
Place  
Date and hourENTRUCKING TABLE <sup>a</sup>

1	2	3	4	5	6	7	8	9	10
Group No.	Troops <sup>b</sup>	Motor transport as- signment	REGULATING POINT and date and hour head passes same	Route from regu- lating point to entrucking point	ENTRUCKING POINT and hour head reaches same	Hour entrucking begins	Hour head leaves entrucking point	Route from en- trucking point to initial point	INITIAL POINT and hour head passes same

(Authentication)

(Signature)

Column clears initial point at -----

<sup>a</sup> This form will be used for a detrucking table by substituting detrucking for entrucking.<sup>b</sup> It should be shown what elements (e. g., foot troops, carts, rolling kitchens, animals) of each tactical unit noted in this column are to be moved by motor transport.

RP = Regulating point  
 EP = Entrucking point  
 IP = Initial point

## WORK SHEET FOR PREPARATION OF ENTRUCKING TABLE

1	2	3		4	5	6	7	8	9	10	11
Group No. (order of clearance of IP)	Number of trucks assigned	Time-length of motor transport (minutes)		Hour head passes RP. (For group 1; hour head of column arrives at RP plus delay of head of column at RP) <sup>a</sup>	Time-distance RP to EP (minutes)	Hour head arrives at EP (4+5)	Time-distance EP to IP (minutes)	Time that group is held at EP before entrucking begins (minutes) <sup>b</sup>	Hour entrucking begins (6+8)	Hour head leaves EP. To column 9 add 15 minutes, if loading personnel only; add 30 minutes, if loading personnel, animals, and equipment	Hour head of group passes IP (7+10) <sup>c</sup>
		In	Out								

<sup>a</sup> For succeeding groups add to the hour at which the head of preceding group passes RP the "in" time-length of the preceding group (column 3) plus additional delay, if any, of the group considered.

<sup>b</sup> For first group in any column solve equation 1 below; if result is positive, enter value in column 8; if negative, enter zero. For second and succeeding groups, solve equation 2.

Equation 1:  $x = T - t + L - 1$ , in which—

$x$  = Time, in minutes, that group is to be held at EP before entrucking begins.

$T$  = Time-distance of longest route through area, RP to IP (columns 5 and 7).

$t$  = Time-distance of group considered, RP to IP (columns 5 and 7).

$L$  = Total "in" time-lengths of groups preceding the group that moves over the longest route.

$1$  = Total "out" time-lengths of group preceding the group that moves over the longest route.

Equation 2:  $x = B - A$ , in which—

$x$  = Time, in minutes, that group is to be held at EP before entrucking begins.

$A$  = Time group arrives at EP (column 6), plus time allowed for loading, plus time-distance EP to IP (column 7).

$B$  = Time head of preceding group passes IP (column 11) plus "out" time-length of preceding group (column 3).

<sup>c</sup> To find hour last group clears area, add last entry in column 3 to last entry in column 11.

■ 77. SHUTTLING.—Any shuttling movement to work smoothly should be graphed and a march table made from the graph. To facilitate a prompt start of the movement, an entrucking table should be used for the first serial to avoid confusion and delay. A study should be made so that the column may be easily and quickly reversed. Time to accomplish this should be allowed. There are four ways in which shuttling may be performed:

a. By transporting troops of each serial the entire distance from the initial point to the destination. This method is normal. It is easier on the troops than the other methods, but is slower.

b. By transporting the troops of the first serial from the initial point to a previously reconnoitered "turn around" short of the destination, from which point the troops of the first serial proceed by marching while the convoy returns to form another serial. Meanwhile the troops of the second and remaining serials have proceeded without motor transportation from the initial point toward the destination. When met by the returning convoy, the troops of the second serial are picked up and transported by motor to the "turn around," where they dismount and proceed as did the troops of the first serial. This process is repeated until the troops for the last serial are met and transported all the way to the destination. This method of shuttling is used when time is pressing.

c. By having the convoy return all the way to the initial point for troops of subsequent serials after having unloaded the preceding serial at a previously reconnoitered "turn around" short of the destination. This method results in a greater saving of time than the first method but is more fatiguing to troops.

d. By transporting the troops of the first serial all the way from the initial point to the destination, where the convoy turns around and returns for troops of subsequent serials which have meanwhile proceeded from the initial point along the route of march. This method has the same advantages and disadvantages as the third method.

■ 78. SUPPLY.—a. The essential items of operating supplies are gasoline and lubricants. The quantities necessarily de-

pend upon type of vehicle, number of vehicles, distance to be covered, and to a lesser degree the roads and weather.

b. Each unit should determine how many gallons of gasoline and lubricants it consumes for each mile of operation. In a company or battery of mixed equipment the average mileage of each group becomes known; for example, ten trucks average 10 miles per gallon, five passenger cars average 15 miles per gallon, two motorcycles average 40 miles per gallon. Then all ten trucks consume 1 gallon per mile, all five passenger cars consume .33 gallon per mile, and two motorcycles consume .05 gallon per mile. The organization consumes 1.38 gallons per mile. In computing the averages, allowance should be made for warming up and other idling periods. Other operating supplies may be computed in a similar manner.

c. With the figure based on consumption per mile submitted to higher headquarters for each lower unit, the requirements become known and are easily applied to any given distance. Appropriate modifications must be made when continued low-gear operation which might change this average condition is anticipated. In case vehicles are assembled for convoy or other transport needs, the number of vehicles of each type, their average mileage expectations, and gas tank capacity should be ascertained. The quantity of supplies may then be closely calculated. Application of these data will dictate when the vehicles need refilling and how much each vehicle should take to complete the march. Provisions may be made to refill at the appropriate time.

d. Local purchases of rations, operating supplies, and rentals are covered in pertinent Army Regulations. An officer appointed as supply officer or agent disbursing officer for a motor march should contact the local quartermaster and disbursing officer in advance for instructions.

## SECTION VI

### ORDERS

■ 79. IMPORTANCE.—The importance of proper orders for motorized movements must be impressed on all concerned. These orders cannot be improvised. They are the expression

of carefully laid plans for the preparation, organization, and systematic control of the move.

■ 80. **FORM AND TYPE.**—As is the case in other military operations, the form and type of order best adapted to the particular situation is employed. Ordinarily a march order is in the conventional fire-paragraph form, complete with annexes. Under other circumstances oral fragmentary orders suffice.

■ 81. **WARNING ORDERS.**—Warning orders usually precede the movement or march order. They should be issued as soon as information of a move is received.

■ 82. **ORDERS FROM HIGHER HEADQUARTERS.**—Where a march is a part of a larger movement, the logistical study necessary to make full use of the road net usually results in fairly detailed orders from higher headquarters. Time limits on movements, zones of movement, or even routes, as well as numerous other details, appear in the order. If corps or army transportation is detailed to supplement that of a smaller unit, specific orders pertaining to one specific move may accompany it. On the other hand it may be assigned during a given period under general instructions only. If the orders received from higher authority are not in specific detail, a motor column commander with the aid of his staff must work out the applicable details before issuing his own orders.

■ 83. **STAFF PLANS.**—The logistical study necessary to the formulation of a movement order is discussed in section V.

■ 84. **PRINCIPAL ITEMS INCLUDED.**—The composition of orders is the subject of other training literature. The principal items to be included in a march order, when applicable, are as follows:

a. So much of the situation as is necessary to a clear understanding of the mission.

b. A concise statement of the mission.

c. Organization for the march, showing the composition and the commander of each element.

d. Instructions to security detachments, reconnaissance and pioneer (demolition) elements, marker and traffic-control detachment, and maintenance and evacuation elements: place and time of departure, mission, special instructions, method of rejoining, and method of communication with the main body.

*e.* Instructions to main body: Place and time of departure, method and rate of march, control information, route or routes, regulating points, cross road interferences, and destination. In case of supply convoys, include location, nature, bulk, and tonnage of supplies, receiving agency, special runs, and disposition of convoy when movement is completed.

*f.* General instructions: road restrictions, alternate routes and detours, light restrictions, precautions during halts, special instructions regarding march discipline, location and identification of assembly areas and entrucking and detrucking points, manning and mounting of anti-aircraft and anti-mechanized weapons, special purpose roads, and priority.

*g.* Administration and supply details: railheads, distributing point, replenishment of gas and oil, messing, evacuation of personnel and vehicles, and special communication instructions such as radio use and frequencies.

*h.* Date and hour of opening new command post and of closing the old one, and positions en route.

## SECTION VII

### RECONNAISSANCE

■ 85. GENERAL.—*a.* The length of columns and the limited tactical mobility of a large number of motor vehicles render motor movements particularly vulnerable. Early and timely reconnaissance is therefore especially important for motor movements. Because of the extremely diverse conditions as to time, assistance from higher headquarters, etc., under which motor movements are made, this subject is treated in broad outline only.

*b.* Air reconnaissance is imperative during each motorized move of any consequence to give warning of impending hostile air and mechanized attack.

*c.* Important motor movements must be covered by mechanized vehicles. They supplement the air reconnaissance directed against surprise mechanized attacks.

*d.* Route reconnaissance to prevent delays is most important.

■ 86. ROUTE RECONNAISSANCE.—*a. General situations.*—There are two general situations under which route reconnaissances

are made. First, the move is part of a large-scale movement which has been planned and coordinated by higher headquarters. Under such conditions, route reconnaissance and repair usually have been accomplished by engineer troops. However, route reconnaissance must precede every motor column, since enemy bombing or weather conditions produce constant and sudden changes in roads and routes. Second, there is the opposite situation in which the units are making the move on their own resources. This is usually the case in peacetime marches.

*b. Detailed duties.*—The detailed purposes of route reconnaissance are as follows:

(1) Where a zone of action only has been indicated, the selection of suitable routes is of primary importance. Detailed information as to the nature and condition of roads, their surface, grades, and width is important. Particular attention is paid to the existence of road mines and blocks and gassed areas.

(2) Alternative routes are selected. If given by higher headquarters, they are reconnoitered and studied.

(3) In addition, when time permits, a complete set of detours for both main and alternative routes should be worked out so that if anything keeps the column from continuing on its selected route it can be detoured without delay. On certain routes detours may involve a reversal of the convoy column. Places where this can be done must be studied out beforehand and checked by actual reconnaissance. Unforeseen delays in motor movements are inexcusable on the part of reconnaissance personnel unless due to acts of the enemy or acts of nature which cannot be foreseen. Even then the reconnaissance officer must have a plan for reducing the delay to a minimum.

(4) Bridges, viaducts, and underpasses are inspected for condition and possible loading with explosives and their dimensions and capacities noted.

(5) Obstacles, to include fords, difficult places in the road, soft terrain, etc., are noted.

(6) If a pioneer detail is not present but is to follow, an estimate of the men, tools, material, and time required to eliminate or reduce the obstacles becomes necessary.



(7) Detours around congested areas are sought when possible.

(8) The selection of bivouacs and assembly areas is usually necessary.

(9) The selection of halt sites for small units is usually directed.

(10) Particularly for peacetime marches, information on the following points of a supply nature is necessary. In such cases the supply officer should accompany the reconnaissance officer.

(a) Places procurable and hours of distribution of fuel, lubricants, parts, rations, or other supplies to be obtained en route.

(b) Repair and replacement facilities for armament and vehicles.

(c) Evacuation and hospital facilities.

(d) The use of ferries and bridges, with toll charges.

(11) When time is limited, the reconnaissance officer may be charged with and provided with facilities for—

(a) Route marking.

(b) Necessary pioneer work.

■ 87. MEANS AND EQUIPMENT.—Means and equipment for reconnaissance must be drawn up to suit the particular case.

*a. Personnel.*—The officers and men selected for this duty must be intelligent, have a sense of direction, possess facility with maps, and have retentive memories and good vision.

*b. Vehicles.*—Sufficient light vehicles, preferably with good cross-country performance, are a requisite. Speedometers of these vehicles should be checked. A mechanic, with a few parts, should be with the party.

*c. Communication.*—Communication facilities in the form of radio and motorcycles are important.

*d. Maps.*—Suitable maps are provided.

*e. Aircraft.*—If time is limited, certain types of aircraft are valuable. They increase the radius of action of the reconnaissance party.

*f. Additional details.*—Pioneer detachments and route-marking details may be included in the reconnaissance party.

■ 88. INSTRUCTIONS.—Instructions for reconnaissance should cover the following points:

a. The routes to be reconnoitered, in each case specifying a definite distance or definite destination.

b. The nature of the information desired.

c. Where the report is to be made and the time limit within which the information is to be delivered.

d. Personnel and equipment available.

e. Data as to the type of loads and vehicles of which the march will be composed.

■ 89. **NORMAL PROCEDURE.**—a. After first studying such information as may have been given out by higher headquarters, the reconnaissance officer makes a map reconnaissance followed by the route reconnaissance. If an actual route reconnaissance is not practicable, movement schedules may be prepared from maps alone. An actual advance reconnaissance of the route should be made, however, even if the reconnaissance party precedes the convoy column by no more than a few minutes.

b. The operations and supply officers may accompany the reconnaissance officer. If the operations officer remains behind, he prepares the movement schedules and march graphs from a map study, checking his work later against the new information obtained by the reconnaissance officer.

c. A work sheet such as shown on page 62 is useful for recording data obtained on reconnaissance. During the actual reconnaissance, the officer checks and notes all data required by his instructions, and, when time permits his return before the beginning of the march, those data necessary to form a march table.

■ 90. **FORDS.**—Fords are inspected for passability, particularly with reference to depth, condition of bottom, and strength of current. The exact route through the ford is carefully marked.

■ 91. **BRIDGES.**—a. Bridges should be carefully checked whenever there is any question of their condition or capacity. If found damaged or weak, a detour must be found or the bridge must be strengthened. In general, division loads can be carried on all Federal, State, and county bridges.

b. The following formulas allow a large factor of safety in determining the capacity of small bridges:

(1) For *wooden stringers* (bridge timbers) :

$$W = \frac{50bD^2}{L}$$

in which

$W$  is the concentrated safe load, in pounds, on one stringer.

$b$  is the breadth of the stringer, in inches.

$D$  is the depth of the stringer, in inches.

$L$  is the span, in feet (distance in feet between stringer supports).

(2) For *steel stringers* (average breadth of I-beams is considered; the large factor of safety allows for special shapes) :

$$W = \frac{1000D^2}{L}$$

in which

$W$  is the concentrated safe load, in pounds, on one stringer.

$D$  is the depth of the stringer, in inches.

$L$  is the span, in feet (distance in feet between stringer supports).

To be of equal capacity the flooring should be at least as thick in inches as the stringers are apart in feet.

c. The first step in the examination is a general survey to determine the condition and soundness of the timbers and metal parts. Timbers are examined by striking, boring, and by driving nails to determine the extent of any unsoundness; an estimate is made of the size of sound timber remaining. Fastenings such as nails, bolts, rods, and rivets are considered. The wash at footings and approaches and the general vertical and horizontal alinement of the whole structure must be examined. Repair expedients are discussed in chapter 4. When passing through country filled with enemy sympathizers a careful examination for sabotage should be made. Accurate information of the gross axle weights of the heaviest loads in the column, distances between axles, and overall heights and widths must be available for bridge reconaissance.

■ 92. CONGESTED AREAS.—*a. General.*—When a column is to pass through cities of considerable size or other congested areas under either civil or military control, arrangements

should be made to obtain guides or a police escort to protect and direct the column. A thorough reconnaissance may indicate that the route can be simplified or shortened by the use of detours to avoid traffic congestion or by the use of the marked routes over high-grade paving used by civilian traffic. However, it still may be necessary to mark the route in great detail. These considerations indicate that reconnaissance officers should precede the column a sufficient distance to permit such action. When time does not permit such detailed reconnaissance, it may be advisable to telegraph or telephone ahead, requesting police guides, and stating the place and hour of arrival, length of column, and destination or general route to be taken after passing through the city. When practicable, arrival at large cities should be so timed as to permit passage when normal traffic is at the minimum.

*b. Information obtained by reconnaissance officer.*—(1) On peacetime marches, all municipal regulations affecting the march of the column while in the city.

(2) Approximate time required to pass through the city.

(3) Length of columns and distances desired between vehicles.

(4) Speed to be maintained and point at which normal speed may be resumed.

(5) Whether the column can be divided and sent over two or more routes when passing through the city.

(6) The location of suitable camp sites or billets if the command is to halt in the area.

■ 93. PIONEER WORK.—The pioneer work with which the reconnaissance officer may at times be charged is covered in chapter 4.

■ 94. ROUTE MARKING.—The reconnaissance officer may also be charged with route marking.

*a. Markers.*—Markers should be placed at all points where the column may go astray, and where congestion, delay, or accident may occur.

*b. Guards.*—Wherever railroad crossings or lefthand turns into a main highway occur or one way obstacles are found, a noncommissioned officer should be stationed.

*c. Guides.*—Wherever organizations leave the road and travel over short stretches of difficult ground into a bivouac

or assembly area, it may be preferable to employ guides to lead the column. If guides are to return to bring their organizations in after dark, they should go over the route slowly, observing every detail that will mark the route in darkness. Pieces of white cloth or paper will assist at night in identifying points.

*d. Instructions.*—Instructions to markers, guides, and guards should be concise and complete, and care must be taken that their orders are thoroughly understood. They should be carefully instructed in the proper use of standard arm signals and flags in proper route marking (fig. 11).

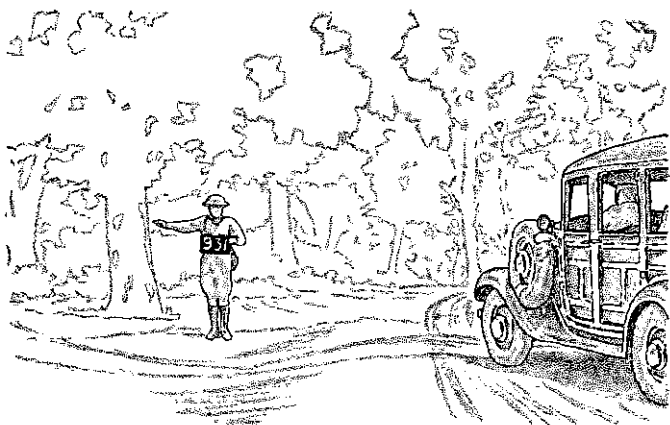

FIGURE 11.—A route marker.

*e. Procedure.*—(1) The following is a satisfactory procedure for posting and collecting marker personnel for motorized units:

(a) Before starting out to mark the route the reconnaissance officer distributes the reconnaissance detail in reconnaissance vehicles in such a manner as to leave one vehicle empty.

(b) The detail moves out sufficiently far in advance to permit marking the route without interfering with the marching column.

(c) Assume that the reconnaissance officer has three reconnaissance vehicles in the order A, B, C, from front to rear, and that B and C each carry five markers while A carries only the reconnaissance officer and driver. Let point X be the position of the first marker to be posted (fig. 12).

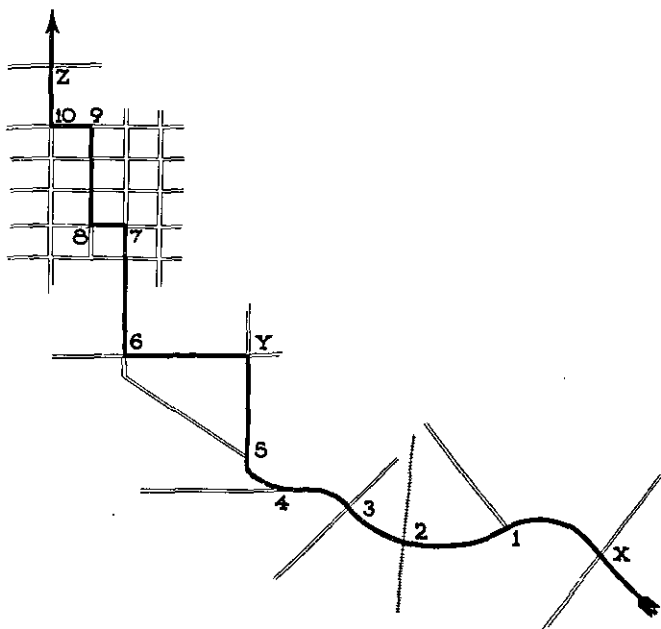

FIGURE 12.—Route marking.

(d) On or before reaching point X, the reconnaissance officer gives to the driver of vehicle A instructions for marking point X. The driver parks the empty vehicle and assumes his position as marker. The reconnaissance officer then mounts vehicle B, now at the head of the column, where he will be able to control the movement of the reconnaissance party and be in position to give instructions to the next marker. In a similar manner markers 1, 2, 3, 4, and 5 from reconnaissance vehicle B are posted in order.

(e) Reconnaissance vehicle B is left at point Y, the driver acting as marker for that point; the detail proceeds, posting markers from reconnaissance vehicle C in the same manner.

(f) When the march column clears point X reconnaissance vehicle A follows and picks up markers 1, 2, 3, 4, and 5; it then joins the rear of the column in a position just ahead of the last motor officer or repair truck. In a like manner, when the column clears point Y, reconnaissance vehicle B follows and picks up markers 6, 7, 8, 9, and 10 in turn. These loaded reconnaissance vehicles remain at the rear of the column until a halt or other condition permits them to pass the column and rejoin the reconnaissance officer.

(2) The personnel used for marking may be reduced by the use of flags and signs in daylight. Where flags are used they must have a prearranged code. Their meaning must be understood by all concerned, particularly the drivers. Signs should be large enough for the driver to see as he passes. They may be placed on a flat surface or merely consist of an arrow, indicating direction, painted on the ground.

(3) During darkness, markers should be equipped with flashlights which have been covered with one or two thicknesses of blue denim. Luminous markers or improvised marker lights, such as kerosene or lard bombs, or candles or waste oil placed in cans, may be used at narrow or dangerous places where no change of direction is involved.

(4) If markers are numbered consecutively from the beginning to the end of the route, the reconnaissance officer and his assistants will have a means of checking whether any marker has been missed. The error will be detected shortly after it occurs and only a short distance will have to be traveled to pick up the missing man. A distinctive marking or flag should be placed on the last vehicle in the column so that members of the marking detail will surely identify the end of the column.

## SECTION VIII

### DEFENSE AGAINST AIRCRAFT AND MECHANIZED FORCES

■ 95. PROTECTION AGAINST AIRCRAFT.—Any marching column must adopt every possible means of defense, both passive and

active, to minimize losses, reduce delay in movement, and discourage attack aviation.

*a. Passive defense.*—Passive measures may be adopted to include the following:

(1) *Concealment.*—Concealment is practically impossible during a daytime march, even if air superiority is obtained. Marches at night and during periods of poor visibility afford the closest approach to concealment while marching. Certain measures should be taken at all times to conceal, as far as possible, indications of movement which would disclose unnecessarily a favorable attack target for aircraft. It should be possible to conceal from the air indications of extreme activity, at both the entrucking and detrucking points by utilizing available cover, by spreading the activity over a large area, by avoiding the grouping of vehicles, by keeping non-essential movement to the minimum, by designating the avenues of travel, by avoiding halts at the start of a march or prior to going under cover at the termination of the march, and by controlling the use of lights.

(2) *Dispersion.*—A column with increased distances on the road presents an unfavorable target for attack aviation because of its lack of density. It forces attack aviation to make each vehicle an individual target and prevents the destruction of more than one vehicle by a single bomb.

(3) *Deception.*—Sudden changes in the direction of march, sending out the vehicles in small groups with a time interval and increased distances, and mixing small groups of vehicles in the normal traffic give an air observer the impression that the target is too transient for attack and deceive him as to the extent of the movement.

(4) *Halts.*—Normal halts should be planned, where practicable, to be made in areas of winding roads and wooded stretches, since straight line air attacks are avoided and concealment is facilitated. Halting the vehicles during an attack increases the probability of hits by anti-aircraft weapons and often prevents the wrecking of a vehicle as a result of the driver being injured or the vehicle being rendered uncontrollable. If ample warning is given of an impending attack, vehicles may be driven to concealment, the straight line appearance of a column and the density broken, and the anti-



aircraft fire rendered more effective. On the other hand, continual halts may adversely affect the movement, and it may be better to continue the march, with increased distances, and suffer the losses.

(5) *Security*.—Security measures include the posting of air observers throughout the column and the use of observation planes.

(a) The posting of air observers places the responsibility for warning on one individual, whose sole duty is continuous observation. This is important because of the short length of time a low-flying attack airplane is visible. Each observer on a vehicle should be assigned a specific direction.

(b) Observation aviation properly employed will in most cases be able to give timely warning of the approach of enemy attack aviation. This warning may be transmitted by radio, pyrotechnic signals, dropped messages, or wing signals.

(6) *Speed*.—Rapidity of movement may often save a column from the danger of attack. It takes an appreciable length of time for observation airplanes to report a column and have the attack airplanes dispatched. Usually a column which will be exposed only two hours need have little fear of an organized attack. Transient attack airplanes are always a danger.

b. *Active defense*.—Active defense includes the employment of weapons.

(1) Antiaircraft machine guns or automatic rifles should be used to protect the head, the tail, and interior portions of the column. The weapons to protect the ends of the column should precede and follow at about 600 yards on a straight road. Other sections of these weapons should be 100 yards ahead and behind the column for protection at sharp road bends. Additional weapons should be loaded and ready for use.

(2) All weapons suitable for firing at low-flying airplanes should be manned wherever air attack is possible. Training in the proper use of all light weapons, both from moving and stationary mounts, is essential. During halts there should be no lessening of the readiness of the command for active defense, full advantage being taken of the terrain.

(3) Antiaircraft defense detachments, posted in advance for area defense of defiles or areas favorable to attack, are important security measures.

■ 96. DEFENSE AGAINST MECHANIZED UNITS.—The term mechanized unit as used herein includes all units equipped with armored combat vehicles, whether they be scout cars, armored cars, combat cars, or tanks. The term antimechanized defense embraces all measures for security and defense, both active and passive, against units equipped with armored combat vehicles. The following measures for reconnaissance, security, delaying action, and resistance should be applied to any marching column where danger of attack from mechanized units exists.

*a. Reconnaissance.*—(1) Reconnaissance agencies operate in those directions from which a command may be threatened by a mechanized attack in order to give timely warning of any danger. It is therefore necessary in pertinent cases to have detailed reconnaissance made of the front, rear, and flanks of a marching column. The usual means which are at the disposal of or can be made available to a commander of a march column are aircraft, scout cars, and cavalry.

(2) Airplane observation is essential to give timely warning and permit the defense to operate to its fullest extent. Scout cars, cavalry, or designated vehicles should be organized in groups and so controlled that an encounter with mechanized units will permit the return of at least one of the vehicles. For long columns, the flank reconnaissance detachments should be so organized that the ground is under observation at fairly frequent intervals of time and a mechanized force will not be able to infiltrate to a favorable area unnoticed. This entails several parallel reconnaissance units in addition to the reconnaissance of the connecting road net.

*b. Security.*—(1) The antimechanized weapons available include the .50 caliber machine guns and antitank guns for direct fire, and the division artillery for interdictions, concentrations, and direct fire. Attack aviation may be most effectively employed against mechanized units while out of artillery range and in movement to and from an assembly area. The security elements armed with appropriate weapons can be spread through the column with a heavy grouping of

weapons in the advance and rear guards. If one or both flanks are exposed, all or part of this antimechanized detachment may be assigned to a flank column or detached as a flank guard to provide security along some well-defined terrain line.

(2) Planning the route of march to take advantage of the normally protected areas along the line of communication and around supply establishments will permit more effective grouping and handling of the security detachments, particularly when mechanized units threaten a flank.

(3) Motor convoys operating back of the front should receive protection by suitable escort or by an outpost system along the exposed flank or flanks.

(4) Thorough map reconnaissance and prior road reconnaissance, if practicable, will enable a commander to plan alternative routes in case of attack. The speed of a motor column may be utilized to advantage by either traversing quickly the threatened area or by changing the direction of march and organizing a rear detachment of mobile road blocks to effect continuous delay and permit escape. Careful planning will at times permit a commander to select a route limited by natural barriers to a few avenues of approach, and a high degree of security may be obtained by proper use of obstacles and demolitions. During halts, full use should be made of terrain lines or features which restrict operation of mechanized vehicles, and security detachments and observers should immediately be placed in positions of readiness. Guns placed on vehicles should be capable of firing from them.

*c. Delaying action.*—Upon contact the security detachments should construct road blocks and defend them with their weapons. A road block can usually be constructed from materials available, such as trees, wire, or even trucks placed crosswise on the road. The selection of the ground for the construction of road blocks should be such that the ground adjacent to the block will not permit a ready detour. Demolitions, road mines, and gas should be utilized to their fullest extent. Hand grenades may be employed effectively on certain mechanized units if dropped from above or exploded under the vehicle.

*d. Resistance.*—When combat is inevitable the command should be prepared for active defense. The degree of surprise dictates the method of resistance. It varies from no warning, when each local commander utilizes to the fullest extent the means immediately available, to a well-organized defense when ample warning is given. The more timely the warning the greater should be the readiness for action. The defense must be organized from two viewpoints, local protection of the troops nearest the enemy and protection of the command as a whole. Vehicles are stopped and the road is cleared, troops dismount, artillery goes into position, and anti-tank weapons are placed in concealed positions to cover the terrain over which the enemy's mechanized vehicles must advance.

## SECTION IX

### EXECUTION OF THE MARCH

■ 97. **GENERAL.**—While no distinction is made as to type of march in the majority of subjects treated in this section, most of the problems are of marching columns rather than of marches of the infiltration type.

■ 98. **TIME OF STARTING.**—The tactical situation determines the time of starting for marches made in the combat zone. The important factors are the prompt organization and the timely dispatch of the reconnaissance party, pioneer detail, route-marking party, and other necessary traffic-control personnel. Organization should take place immediately upon receipt of the warning order. The reconnaissance party, together with other necessary personnel, should be dispatched as soon as sufficient pertinent information is available or in sufficient time to permit them to accomplish their mission without delaying the march column.

■ 99. **COLD-WEATHER MARCHING.**—Marches executed in cold weather must be preceded by proper warming up of engines (at least 140° F.) and freeing of tires from ice before any unit is allowed to move out to the initial point.

■ 100. **ENTRUCKING.**—In a large movement of troops by trucks, the necessary coordination is effected by detailed staff plans which take the form of entrucking and detrucking

tables. In small moves, when the column is acting independently, the following methods apply:

a. In a cargo convoy the loads may be loaded sometime prior to the start of the march, while in a troop movement the personnel are entrucked just prior to departure. Tactical necessity may outweigh consideration of the comfort of the men as well as the rated tonnage capacity of the trucks. Movements made in this manner usually begin from a bivouac. Since this usually means the occupation of a considerable area, the problem becomes one of getting the troops and the trucks together promptly. When troops are bivouacked within 2 miles or less of the vehicles, it will ordinarily be more expeditious to march the troops to the vehicles for entrucking. For distances in excess of 2 miles, time will be saved by moving the vehicles to unit assembly areas. The vehicles allocated to each march unit of the column are parked in dispersed formation for protection against air attack and artillery fire. The troops to be carried on each truck are formed and are conducted to the truck by a guide.

b. When an infiltration move is in progress, loaded march units remain in the bivouac area with the vehicles dispersed until dispatched. *A column is never formed halted on the road.*

■ 101. INITIAL POINTS.—For data on initial points, regulating points, and entrucking formations, see section V. Some readily recognizable terrain feature is designated as an initial point. The march order may designate the time each march unit passes this point. In difficult country, guides on motorcycles or in light vehicles should be provided to lead march units to the initial point. March units should not break cover and stand massed at the initial point waiting for the hour of departure. There should be no halting at initial points under any circumstances.

■ 102. RATES OF MARCH AND SPEEDS.—See sections II, III, and V.

■ 103. COMMAND, COMMUNICATION, AND CONTROL.—See sections III and IV.

■ 104. CONGESTED AREAS.—See paragraph 92 and section X.

■ 105. HALTS.—Halts for moves of less than 3 hours' duration are unnecessary. Halts for large columns usually are pre-

scribed in orders from higher headquarters. In such cases, halts at the end of the first hour cannot be made, since part of the column is not on the road. For smaller columns, where the choice lies with the column commander, a halt of 15 minutes at the end of the first hour should be made. Thereafter, a halt of 10 minutes every 2 hours is sufficient. During peacetime a noon halt of 30 to 40 minutes for lunch may be added. During combat this invites air attack. Drivers and assistant drivers change duties at halts.

*a. Selection of halting places.*—Halting places may be selected in advance by the reconnaissance party. Care is taken, when possible, to select halting points in the country where the halted column will least interfere with other traffic. When there is a choice, wide rather than narrow stretches of the route are best. To avoid halting a convoy on a narrow country road, it is advisable to delay regular halt periods for as much as a half hour or more until a better place is reached. When a column starts from a populous area, its first halt should be delayed until the country is reached. Likewise, when it is practicable, halts in peacetime should not ordinarily be made in villages or towns unless there is a special reason therefor. Crossroads, railroad crossings, and similar points are avoided as far as possible. If such a point lies within the halt area of a column, the leader of the sections near the crossing sees to it that his vehicles park in such a manner that the crossing is well cleared. It is also undesirable to halt so that any part of a column rests on steep grades or hill crests. Shade for personnel and water for filling radiators and for washing are desirable at all halts, especially at halts for meals and refueling. A column should, if practicable, be halted so that approaching traffic has at least 100 yards clear view before reaching the columns. The tail of a column must never be halted so that it is hidden from view by the crest of a hill. If necessary, the last vehicle is parked on the crest of the hill.

*b. Method of halting.*—During marches in the combat zone vehicles will not close up upon halting. Similarly, march units will retain their distances from the units ahead. During peacetime marches or wartime marches executed out of range of enemy aircraft this requirement may be waived.

Upon halting, vehicles will pull as far to the right of the road as conditions permit. It is usually best, unless the shoulders of the road are plainly substantial, to keep at least the left wheels on the pavement.

*c. Duties at halts.*—When a halt is made, each driver or assistant driver at once proceeds to make the inspection required in paragraph 21. Personnel except those servicing vehicles remain off the road and to the right of vehicles. They must not loiter between vehicles. Servicing personnel should be constantly on the alert for passing vehicles and should clear the road as soon as their duties permit. A traffic guard should be posted at the heads and tails of columns or subdivisions thereof. A traffic guard should have a red flag during daylight and a shielded red lantern at night. His duty is to slow down, halt, or pass traffic.

■ 106. REFUELING.—The average military or similar commercial vehicle carries enough gasoline in its tank to last 150 miles. Hence on longer runs vehicles must be refueled. This should be done so that no time is lost. Halts for other purposes should be used for refueling whenever possible. Refueling should be accomplished during a day's run before there is any possibility of exhaustion of fuel by any vehicle in the column. If done too early, however, a second refueling may be necessary. The process of refueling should be efficient and should cause little inconvenience to other traffic.

*a. Methods.*—Gasoline is made available to convoys on the road from—

- (1) Tank trucks equipped with spigots and cans.
- (2) Tank trucks equipped with pumps.
- (3) Filling stations equipped with pumps.
- (4) Trucks carrying containers of fuel.
- (5) Containers of fuel carried by each vehicle.

*b. Separate containers.*—Of the five methods given in *a* above the last two are by far the most efficient for refueling a column of any size. Whenever it is practicable, every vehicle should carry its own extra gasoline supply. Failing this, the supply of fuel in 5- or 10-gallon containers which can be passed out rapidly down the length of a column is next best.

*c. Tank trucks.*—Refueling may be accomplished in three ways when tank trucks are used:

(1) Tank trucks may be spotted at intervals along the column. When this is done, drivers carry filled cans to their respective vehicles.

(2) Tank trucks may be spotted off the road at the heads of sections. When this is done, the vehicles of each section move in turn beside the tank trucks where they are refueled by can or pump.

(3) Tank trucks may themselves move along the column from vehicle to vehicle, halting every few trucks when refueling is done by can, or at every truck if by pump.

*d. Fire precautions.*—The engine must be cut off and there must be no smoking on or near a vehicle while it is being refueled.

*e. Vehicles of combat units.*—The vehicles of combat units and those of any unit moving in the theater of operations should be kept filled whenever it is practicable.

*f. Refueling at the end of a run.*—Vehicles are refueled immediately after the end of a run in the manner most practicable.

■ 107. MESSING.—*a.* The messing of personnel on a motor march differs little from that of other troops on the march. Motorized units carry their kitchens with them or utilize field ranges installed in trucks. Troops transported in non-organic motor vehicles are likely to have their own messing facilities with them. On one-day trips or shorter moves, the meal en route is usually a cold lunch, although it is preferable to serve a hot meal whenever circumstances permit. When cold lunches are carried, hot coffee can generally be served from thermos jugs or cans.

*b.* The supply officer is charged with the supply of food during a motor movement. During times of peace he must often obtain foodstuffs locally. In order to facilitate buying and delivery, the supply officer or other agent officer should precede the column when possible; he may accompany the reconnaissance officer or advance agent.

*c.* In group motor-vehicle movements where roads may be available only during a limited period and where 10 minutes are equivalent to 5 miles, delays are costly. Messing, refueling, and servicing must be accomplished on schedule. Supply for group motor-vehicle movements must be carefully planned



and precisely executed. A disorganized system presages an inefficient movement.

■ 108. ACCIDENTS.—*a. In war.*—In time of war the maintenance truck traveling in rear of a serial or convoy stops and gives assistance to a vehicle that meets with an accident. The remainder of the column continues on its route. If an accident blocks the route, the occupants of vehicles in rear clear the way at once, assist the occupants of the damaged vehicle, and then resume their run. The medical officer assists injured as directed by the column commander.

*b. In peace.*—(1) Accidents, however trivial, which result in injury to an individual or damage to property, are reported as soon as possible to the column commander. He or his representative investigates the accident at once, military urgency permitting, sees that the medical officer takes care of any injured, and after giving orders for the disposition of injured and dead, questions witnesses, takes their names and addresses, and when possible takes their sworn statements. The driver unless too seriously injured fills out a driver's accident report form.

(2) In an accident that involves injury to civilians, the injured person or persons should be given first-aid treatment, rendered every other assistance, and taken immediately to the nearest hospital, civil or military.

(3) In case of injury to military personnel when no medical officer is with the column, the injured person or persons are given first aid and taken to the nearest military hospital. If a civil hospital is nearer and an injury is so serious that the soldier's life would be endangered by transporting him to a more distant military hospital, he may be taken to a civil hospital for emergency treatment. In this event the next higher military superior must be notified immediately, giving full details.

(4) Officers and other military personnel at the scene of an accident obtain all information they can regarding injuries to persons, so that full information can be given to the commanding officer charged with appointing a board of officers to investigate the accident or injury.

■ 109. REVERSING DIRECTION.—*a. Methods.*—Circumstances may demand that a column reverse its direction. There are three methods:

By following a route that circles back.

By having all vehicles move up and consecutively turn around (left-about) on the same spot.

By a simultaneous turning of all vehicles on the road.

(1) *Circling back.*—The first method is simple and requires only an available route for circling back. Roads are not necessary for this method when the terrain is firm and passable. A column, for example, can circle out into a field and back to the road. It may be necessary to make a gap in a fence or fill in a side ditch, but either would take far less time than a roundabout detour. Property rights must be respected except when the exigencies of war require otherwise.

(2) *Consecutive left-about* (countermarch).—Crossroads, road forks, or other suitable places are used for "turn-arounds." It is easier and more expeditious for a long column to reverse direction by sections. On a narrow road it may be necessary for each vehicle to turn and back around. As soon as the leading vehicle completes the turn, it moves out in the new direction as from a halt. Other vehicles follow in turn at road distance.

(3) *Turning simultaneously.*—On wide roads or other suitable ground, vehicles may turn simultaneously without confusion. A trained group of drivers with light cars or trucks can execute such a turn easily and rapidly, provided there is no great amount of other traffic. A turn of this kind is best accomplished without closing up the column. A car or motorcycle is sent back down the column to signal each driver to turn his vehicle around. On receiving the signal, each driver slows down and turns his vehicle around with due regard to other traffic, and then resumes running speed in the new direction.

*b. Interference with other traffic.*—(1) There should be as little interference with other traffic as possible except when the urgency warrants such interference. Thus in time of peace it is usually best for a column to move by circling around on a detour, even at the cost of several extra miles.

This cannot be done in war if there is any possibility of interfering with other columns on other roads.

(2) On a four-lane highway with heavy traffic, a column can best reverse direction by consecutive left-about. Other traffic uses the center lanes and passes through the intervals between the consecutively turning vehicles of the column.

(3) Countermarching on a three-track road requires that other traffic be halted in the center lane for a safe distance above and below the point of countermarch until all vehicles have turned around. The more points of turning used, the sooner the whole column is reversed and the less other traffic is delayed.

(4) On roads where traffic is heavy, simultaneous turning by an entire column requires other traffic to be halted ahead and in rear of the convoy.

■ 110. MAINTENANCE PERSONNEL.—Particular attention should be paid to the proper organization of motor maintenance personnel for the task at hand. During long daylight marches part of the maintenance personnel should be permitted to sleep, since it will usually be necessary for them to work all night in order to have vehicles in shape to resume the march the next morning. The same holds true for night marches. In brief, whenever extended consecutive marches are to be made, the maintenance crew must be augmented by all available apprentices and two shifts or reliefs must be organized.

■ 111. WRECKS.—Trucks or passenger cars involved in collisions or turn-overs, wrecked by shell fire, or otherwise badly disabled must be immediately removed from the road. A road bottle neck not only delays traffic in both directions but often causes other accidents. Roads must be kept clear of obstructions. For further details on disposition of disabled vehicles see section IV, chapter 5.

■ 112. BIVOUAC OR ASSEMBLY AREAS.—a. A motor movement under tactical conditions terminates in unit assembly areas either for the purpose of deploying for combat or for establishing a bivouac. For reasons of security, the movement should be practically continuous from the start to the occupation of assembly areas. Large wooded areas and towns make the best assembly areas.

b. Assembly areas should be large enough to accommodate units in dispersed formation, and as far as possible should provide cover and concealment from ground and air. They should be readily accessible to motor vehicles from the route of movement. Hard standing should be provided for heavy vehicles. Vehicles should be dispersed within the assembly area with a minimum distance or interval of 75 yards between any two vehicles. This is considered adequate to present an unremunerative target to hostile aircraft and artillery. Congestion is a constant source of danger. Camouflage and concealment, while always sought, are not satisfactory substitutes for dispersion.

c. Assembly areas are assigned to subordinate units by the commander of each next higher echelon. Each unit commander or his representative at the forward echelon of command posts guides with signs to mark assembly areas and routes thereto. As each truck arrives at the entrance of its assembly area it leaves the route of march and is directed by markers or guides to its position. Detrucking takes place only after each vehicle has stopped in its dispersed location.

d. Signs conspicuously displayed along roads should indicate the location of command posts. Congestion of vehicles near command posts must be avoided and guards or guides must be provided to prevent it.

e. While in assembly areas, all units provide their own local security against air and ground forces. This must be continuous from the arrival of the first vehicle until the area is vacated. Provision is made to protect assembly areas against tanks. Whether further security measures, such as the establishment of an outpost with motor outguards, are taken will depend upon the situation.

f. To avoid delay in issuing orders, representatives of platoon, company, and battalion units must be immediately assembled upon entering an assembly area and remain at the next higher headquarters.

g. After assembly areas have been occupied, each truck moving therein at night will be preceded by a man on foot to avoid running over sleeping personnel.

■ 113. NIGHT MARCHES.—a. Owing to the increasing frequency and importance of night marches, it is imperative that

units be given considerable practical experience therein prior to entering the combat zone. Operation at night when lights are permitted differs from daylight operation only in the measures which must be taken to overcome the adverse influences which darkness exercises upon ease of control and avoidance of accident. In general, speed must be reduced, vigilance of drivers increased, and special measures taken to mark the route. Advance daylight reconnaissance should be made whenever possible. Night marches without lights are particularly difficult for motor columns, especially when made over rough or poor roads. Practicable speeds will vary widely from that possible on good roads on a moonlight night to that of men on foot individually guiding vehicles across a bad stretch of road. Great detail is required in making reconnaissance and in marking routes.

b. Markers (individuals, distinctive signs, caution lights) should, if practicable, be posted prior to darkness, but in any event well in advance of the column. Organizations must provide their own markers not only on marches of their own units but also on combined troop movements where the main column splits up into smaller units moving to separate destinations. In such cases military police are usually not available. A marker thus posted should wear or carry a distinctive organization emblem or marker. He should know how many vehicles are to be directed past his post, as well as the route to be taken by these vehicles.

c. To aid drivers in following in column, each vehicle should be equipped with two night marching lights or with large white markers (about 2-foot square) either attached to or painted on the tail gate. Windshields must be opened. Tail and stop lights are covered. Special precautions are taken to maintain close contact between units in columns. On very dark nights it will become necessary to reduce the distance between march units to the distance between vehicles.

d. *On night marches the strictest march discipline must be enforced* to prevent accidents, to prevent units from becoming lost, and to prevent use of lights and matches. Constant effort is necessary to prevent drivers from becoming drowsy. This may be accomplished by relief every 2 hours,

by dismounting and exercising them during the halts, and by serving hot coffee. Drivers who do not see well at night must be relieved immediately.

## SECTION X

### TRAFFIC CONTROL, RESTRICTIONS, AND CIRCULATION

■ 114. GENERAL.—Orders for traffic control, road restrictions, and circulation are essential both in large movements of vehicles and in areas where traffic conditions are heavy and are ordinarily issued by commanders of large units. Careful planning will permit satisfactory traffic circulation even though the roads are poor and few. The object of traffic control is to prevent accidents; relieve congestion and interference; enforce traffic regulations as to speed, direction of movement, double banking, and use of restricted roads; and assist the troops by indicating direction and giving information. The personnel which usually can be made available include engineers, reconnaissance personnel, military police, and march or vehicle personnel.

■ 115. METHOD OF TRAFFIC CONTROL.—Two distinct methods of traffic control, known as "area control" and "organizational control," are in use. In these methods either the point system, in which fixed traffic-control posts and stations are used, or the block system, in which a suitable advance traffic escort is used to block off interfering traffic, may be employed.

*a. Area control.*—In areas where mass movements of vehicles become so great that they overburden the existing road net or where the road net is poor, coordination of all traffic movements in that area by one authority must be resorted to in order to eliminate congestion and confusion. Under this system one officer is charged with the responsibility of controlling all traffic within his area. With the assistance of a staff and a specialized traffic-control force, he exercises control over the area through the point system of traffic control and through traffic patrols employing the block system. The traffic-control posts are manned by traffic policemen and have wire, radio, or other communication with a master control station. From this master control station traffic orders covering the various phases of control, restriction, and

circulation are issued to all control posts. Large movements of troops are so directed as to best utilize the road net. Traffic priorities are arranged and column movements are coordinated to avoid conflicts. Entrucking and detrucking areas are organized. If for any reason a particular route is rendered impassable, traffic is rerouted to its destination via the best available alternate route.

*b. Organizational control.*—Under this system the organization commander (or the convoy commander in the case of a convoy) is responsible for the control of his organization (or convoy) on the march. Control is exercised mainly through the march order. Control is further exercised by the use of strip or road maps, route markers, guides, unit control stations, signs, and escorts employing the block system of traffic control. Traffic-control personnel for the above uses are taken from the organization itself or from the personnel of the convoy. Procedure in route marking and use of signs and guides is covered in section VII.

*c. Application to various types of marching.*—Control in the three methods of marching is executed as follows:

(1) *Infiltration.*—This type of march may be controlled by either method of traffic control or by a combination of the two. In areas where coordinated area control is established, the area traffic officer normally exercises control. In this case advance arrangements for the move should be made with him. Where coordinated traffic control is not established, the march must be conducted under organizational control. If the march is long, the route should be subdivided into divisions over each of which route markers are posted or control points are established. On routes where considerable traffic is moving, distinctive markers should be provided. Divisions of the route should be interconnected by telephone, radio, or other means of communication. Officer control stations should be established at critical points. Flag signals should be announced to permit signaling to drivers to slow down or stop at control points. Drivers should be issued strip or other maps. Control stations must be prepared to divert traffic to alternative routes when the necessity therefor arises.

(2) *Close column and open column.*—Coordinated area control is well suited to these types of marches. In areas where coordinated control exists, arrangements normally are made in advance with the area traffic officer. Lacking area control the move is controlled by the organization itself. For a detailed discussion on the use of the control car, formations of march units, time intervals between march units, and distances between vehicles, see section III.

■ 116. **TRAFFIC RESTRICTION.**—This applies to any stipulation placed on traffic movements, whether for the purpose of maintaining secrecy or facilitating the circulation of traffic. Restrictions may be prescribed by higher headquarters or may be dictated by the unit commander. In certain situations it may be advisable to designate areas in which traffic of certain classes is not to operate during daylight hours, and areas in which vehicles are not to use lights at night. It may be necessary to reserve particular roads for specified units for stated lengths of time, or to restrict certain roads to the exclusive use of traffic in one direction.

■ 117. **TRAFFIC-CONTROL PERSONNEL.**—*a.* Traffic-control personnel include all persons whose duties are connected with influencing the flow of traffic, whether military or civilian. Although the traffic control in cities is usually taken over by military police during time of war, there are frequent occasions when troops on the march will pass through areas under control of civilian police. Where this contact with traffic agencies occurs, military traffic personnel cooperate to the fullest extent with civilian authorities. Military traffic control personnel includes four classes: engineers charged with road reconnaissance, personnel from the various arms charged with road reconnaissance, military police on traffic duty, and column personnel used for traffic duty.

*b.* Engineers charged with road reconnaissance initiate and maintain a system of reconnaissance, road marking, and inspection in large units. This usually occurs as soon as an area is occupied by an advancing force. It includes recommendations on traffic restriction and circulation. Engineers also post road signs to warn against dangerous points and impassable sections and to give necessary information concerning maximum bridge loads and use of bridges. They



execute whatever pioneer work they can in the time available. All available pertinent information on routes and roads is published by the engineers for the benefit of troops. Mutual exchange of road information is continuous.

c. Personnel from the various arms charged with route reconnaissance mark routes, execute limited pioneer work, and collect and disseminate road information for the use of the troops. They may be specially deputized to act as military police on traffic-control duty.

d. Military police on traffic duty may be stationed at specific control points or may act as traffic patrols. Those at control points direct traffic in a manner similar to that used at busy city intersections. They enforce traffic regulations, act as route markers, and disseminate traffic information. Military police on patrol duty in addition to discharging the duties mentioned above escort large columns on the march and investigate accidents. All military police habitually operate under direction of an officer's control station.

e. Convoy personnel used for traffic duty operate under the direction of the officer in charge of the convoy. They habitually precede the column with the route marking party in motorcycles, scout cars, passenger cars, or light trucks. They prepare the route for the convoy by directing traffic at busy intersections, acting as route markers or guides, posting traffic signs, and executing limited pioneer work.

## CHAPTER 4

### PIONEER WORK, FIELD EXPEDIENTS, AND DIFFICULT OPERATIONS

	Paragraphs
SECTION I. Pioneer parties .....	118-120
II. Field expedients .....	121-137
III. Difficult operations.....	138-153

#### SECTION I

#### PIONEER PARTIES

■ 118. MISSION.—The mission of a pioneer party is to perform such road work as is required to make the route passable.

■ 119. EQUIPMENT.—Personnel and equipment for pioneer parties are based on an estimate of the road work that will be required.

a. Each vehicle in the military service should carry some pioneer tools and equipment to assist in crossing difficult terrain. These will vary according to Tables of Basic Allowances. In general, the allowances will permit the following equipment per vehicle:

- 1 pick
- 1 shovel
- 1 tow chain or cable
- 1 prolonge
- 1 axe
- 1 bucket
- 1 set skid chains
- 1 set wheel lugs, improvised grouser ropes, or other traction device

b. One or more vehicles in a march unit should carry additional equipment for the pioneer party. This equipment is usually carried on the trouble trucks of organizations not equipped with transportation for this purpose. The following will serve as a guide for loading a pioneer truck:

- 1 winch with 300 feet of cable (or equivalent block and tackle if winch is not available)
- 2 towing bars
- 2 shovels
- 1 pick
- 2 axes
- 1 sledge
- 2 heavy iron stakes or crowbars (about 4 feet)
- 1 rectangular log block (suitable for deadman, or wheel block) having two chains attached, long enough to fasten to tow hooks or body frame so that it cannot be rolled over when used to block wheels
- 300 feet 12-gage wire
- 1 saw, crosscut, 2-man
- 2 tow chains (about 15 feet)
- 1 block and tackle (with 300 feet 1-inch rope)

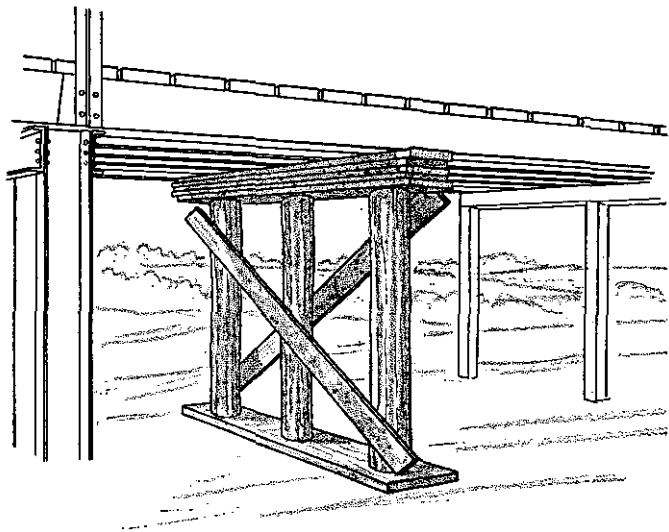

① Bent.

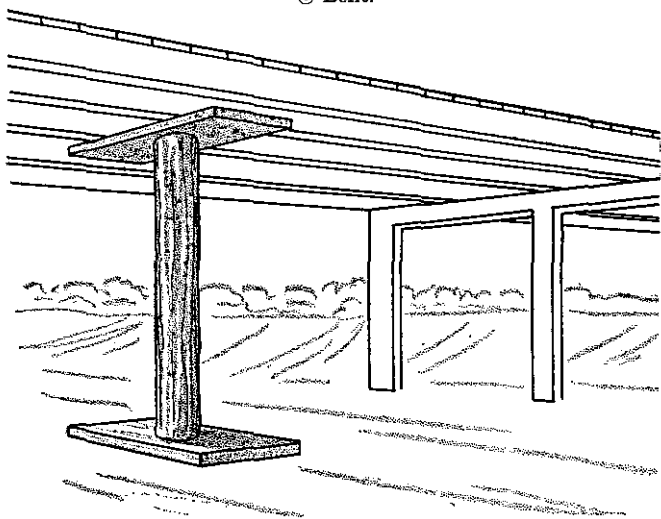

② Single support.

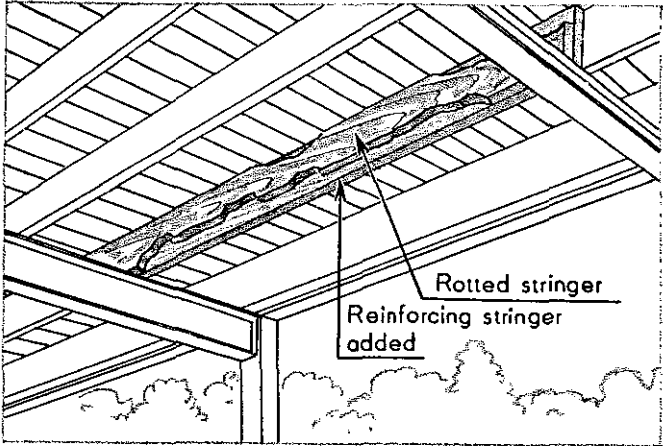

⊙ Added stringer.

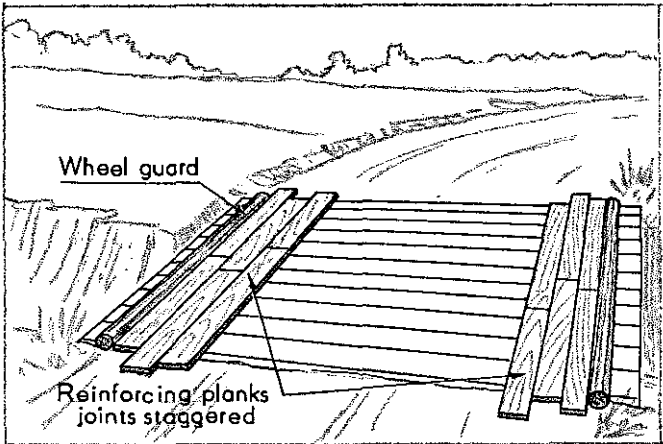

⊙ Additional planking and wheel guards.

FIGURE 13.—Reinforcing bridges.

- 4 wheel mats, rope or canvas
- 2 prolonges

2 I-beams large enough to be used as stringers across an 8-foot span, or enough planks or other bridging materials for the same purpose

1  $\frac{3}{8}$ -inch or larger cable 300 feet long

500 pounds decontaminating material

1 apparatus, demustardizing

■ 120. DUTIES.—The principal operations performed by a pioneer party are as follows:

a. Large obstacles such as rocks, logs, stumps, trees, and holes which cannot be detoured are eliminated.

b. Soft surfaces such as sand, marshes, or loose soil are strengthened by covering with logs, planks, brush, rocks, wheel mats, cornstalks, hay, or like materials. Sand may be covered with chicken netting or tar paper.

c. Ice-covered winter roads are covered with sand or dirt.

d. Ravines and ditches are made passable by breaking down steep banks sufficiently so that running boards, lower parts of the chassis, overhanging front or rear portion of the body, or the spade of a towed gun trail will not hang on the banks. When wet, the bottoms of ditches are strengthened to withstand the wheel impact and spin of heavy vehicles. Logs, rocks, brush, sacks of dirt, etc., are used to fill in; planks or logs are used to bridge across. These materials are secured so that they cannot be displaced.

e. Shallow stream crossings with good approaches and solid bottoms are chosen. Steep approaches are cleared straight down so that there will be no danger of side slipping. Traction is increased where banks are soft or slippery. If this cannot be done sufficiently with brush, hay, etc., ramps may be built with poles. Loose dirt is never added on slippery approaches, in holes, or on steep ascents, because it reduces traction. Rocky creek bottoms are checked carefully against dangerous obstructions. If there are holes or if the bottom is soft, rocks, brush in fascines, or logs are used to fill in and increase flotation.

f. On steep ascents or descents or where a deep crossing is required tackle is placed in position.

g. Bridges which are found to be weak (par. 91) are usually strengthened by the addition of a bent, a single support, or stringers. Where there is danger of loads breaking through

the flooring, additional planks are laid along the wheel tracks to distribute the load. Joints are staggered and planks are nailed down. Wheel guides of heavy timbers, ties, or poles are secured near the safe edge of the bridge to prevent vehicles from running off. (Fig. 13.)

*h.* Rafts are usually built for crossing navigable waters where bridges, engineer equipment, or commercial ferries are not available. Simple rafts large enough to ferry trucks and their towed loads can be built from boats, oil drums, logs, and timbers. Twenty-five 50-gallon drums floated between the cross timbers of a platform will give a capacity of about 10,000 pounds. The outside or end drums may best be lashed to the platform. Care must be taken that the drums are sealed. In crossing a flowing stream a raft may best be utilized as either a trail or flying ferry. In the first method the raft is attached so it will slide along a cable which is run across the river and fastened to either bank. In streams where the current is faster the raft is attached to a long cable which is anchored upstream. In either method ropes are attached from both shores to pull the ferry back and forth.

*i.* Barbed-wire entanglements are cut out and towed away by means of a smooth wire or chain passed around them. In an emergency a truck can go through entanglements under 4 feet high with a fairly good chance of success but with some damage.

*j.* Sections of road and bridges which have been sprayed with persistent chemical agents are decontaminated. Where decontamination is not immediately practicable, detours are selected.

## SECTION II

### FIELD EXPEDIENTS

■ 121. TRACTION DEVICES (fig. 14).—The use of traction devices such as chains, lugs, traction bands, and dual wheels is covered in paragraph 32.

■ 122. TROUBLE TRUCK.—Although equipment in different types of motorized units will vary, each organization should have one trouble truck, usually equipped with a winch. The use of the winch or trouble truck is governed by the following principles:

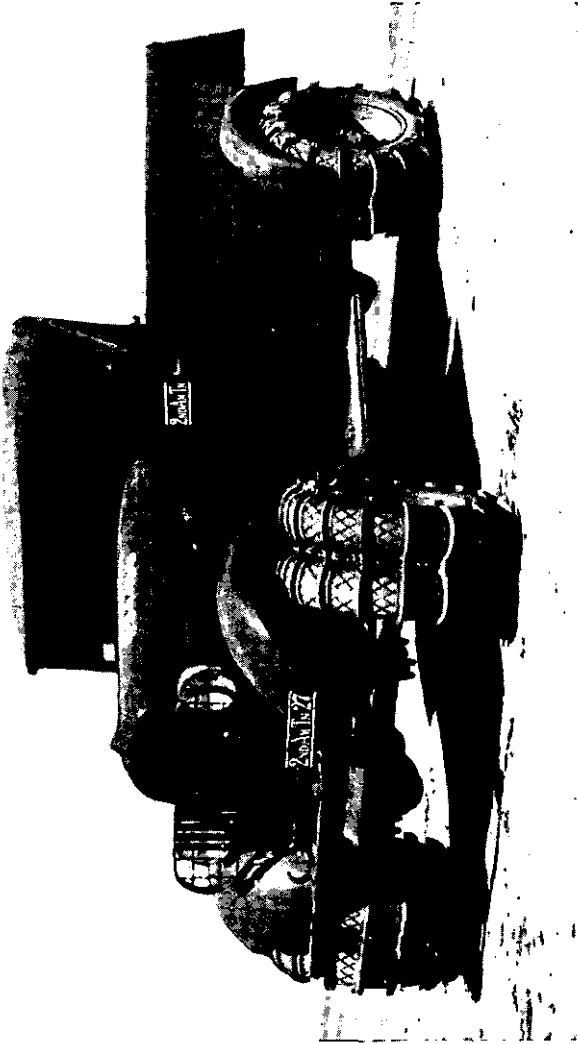

① Giant lugs.



② Traction bands.

FIGURE 14.—Traction devices.



*a.* Although normally placed at the rear of the column, when need for the winch truck can be anticipated, the truck should be brought forward and taken across the obstacle as the first vehicle.

*b.* When necessary, the winch truck is backed across an obstacle under the assisting power of the winch with cable attached to a deadman or tree. The power of the drive wheels should assist the winch, but the gears must be so chosen that the wheels will cover ground faster than the winch cable is pulled in.

*c.* The same principle should be applied when pulling in a vehicle with the winch; that is, the towed vehicle should assist with its maximum traction. The best power combination generally results if the winch is operated in the highest gear that will give sufficient power and the towed truck is pulling in lowest gear.

*d.* After the winch truck has crossed an obstacle, the cable may be run out, the winch locked, and the truck used as a towing vehicle, or the truck may be halted and the winch utilized.

*e.* When the winch is used on a difficult pull, the winch truck may be held in place by use of the brakes, wheel blocks, or by anchoring to a tree or deadman. Traction devices will assist in holding the vehicle in place.

*f.* Certain precautions are necessary in the proper use of the winch cable. Whenever the towing cable is slipped over the ground it should be protected by placing pieces of wood under it. Power must be applied to the cable gradually. As a precaution against the lashing ends of a broken cable, all men should stand clear before the winch cable is tightened.

■ 123. HOIST ATTACHMENT AND WRECKING CRANE.—*a.* A hoist attachment may be issued to units. This equipment is intended primarily for use with the maintenance section. It may be mounted in either the trouble truck or the tender carrying the equipment of the maintenance section.

*b.* A wrecking crane (fig. 15) may be improvised to serve the same purpose as the hoist attachment. The crane is installed so that it extends over the tail gate approximately 4 inches. The winch cable is placed over the crane only when necessary to get an upward towing lift.

c. Either the hoist attachment or the wrecking crane will assist in towing a disabled vehicle in an elevated position when the steering mechanism or the axle is damaged. They may often be of use to give a towing lift on a mired vehicle. Care must be taken not to attempt to lift too heavy loads, which will nose-up the hoisting vehicle.

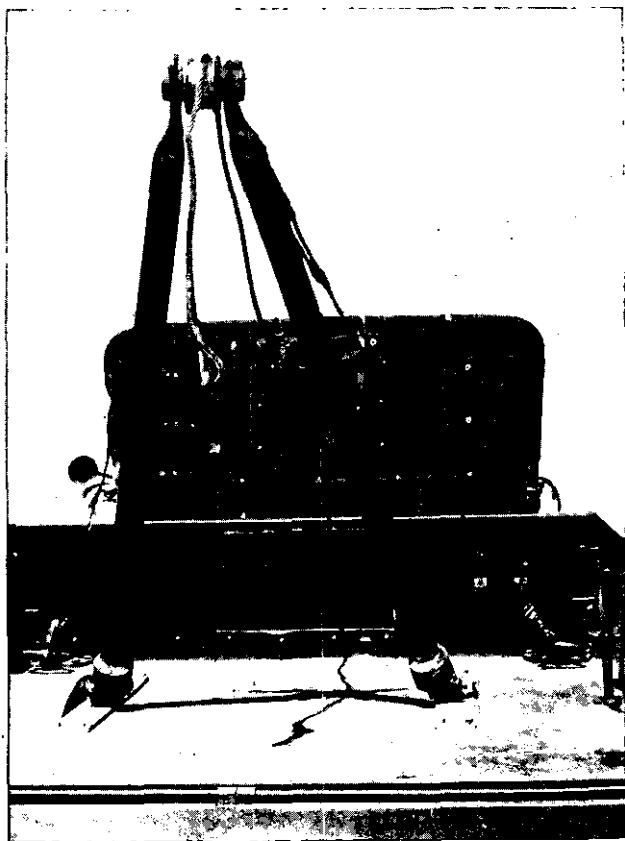

① In position for use.

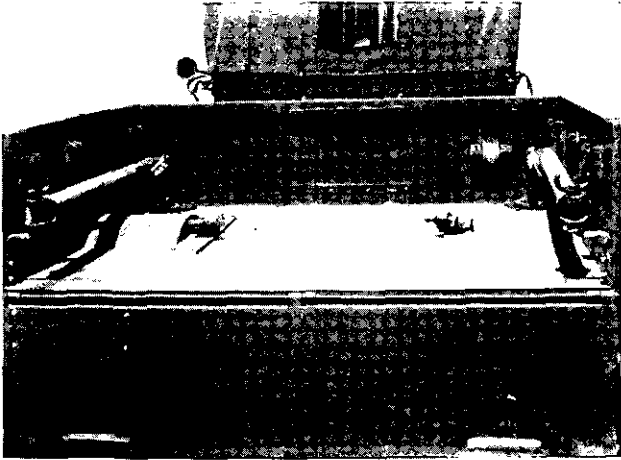

⊙ In traveling position.

FIGURE 15.—Wrecking crane.

■ 124. TRACK-LAYING TRACTORS.—Where available, tractors will serve as powerful towing expedients. They have good flotation and powerful traction. Once the tracks begin to slip, the clutch should be quickly disengaged and the tractor moved out in the opposite direction. A new trial is then made on new footing, inserting a tow chain or cable between the tractor and towed load if necessary. The tractor has little if any more hill-climbing ability than a truck. When needed as a tow in such cases it should be moved to a position where it can pull without climbing a steep slope.

■ 125. GROUSER BARS (fig. 16).—For track-laying vehicles, grouser bars may be improvised. A grouser bar is installed across both tracks by means of the grousers after the vehicle is stalled in a mired position. The vehicle is rolled over it and the bar removed before it strikes the back of the vehicle. A pole or piece of timber may be secured across the tracks to serve the same purpose.

■ 126. GROUSER ROPES OR CHAINS, AND LUG PLATES (fig. 17).—Improvised single grouser ropes or heavy single chains may

be carried when a driver is operating a passenger vehicle alone. If the vehicle stalls on a muddy road, the traction of one or more wheels may be increased by the use of these devices. Makeshifts such as a short piece of rope or web belts may be used for the same purpose in case of an emergency. These should be applied only after chains have failed to give sufficient traction.

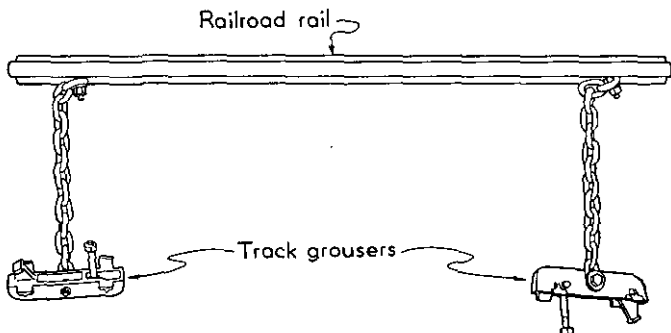

FIGURE 16.—Grouser bar.

■ 127. WHEEL MATS.—Flat mats improvised by braiding together strands of rope, or pieces of heavy canvas, with ropes attached to the four corners are useful to place under the wheels where the going is soft. When a vehicle is stalled with wheels slipping, wheel mats may be used by attaching them to the wheels at one end, or they may be laid down in front of the wheels with the end away staked down. To increase traction over a soft or slippery spot, one or several of these mats may be tied end to end. They may then be staked down or maneuvered ahead of the wheels. Sacks or, in an emergency, blankets and like articles may be used to serve the same purpose.

■ 128. TOW CHAINS OR CABLES.—Tow chains or cables should be about 25 feet long and should have a hook on one end and a ring or loop on the other. Cables and chains  $\frac{3}{8}$  to  $\frac{1}{2}$  inch give sufficient strength.

■ 129. SPREADER BARS (fig. 18).—To prevent the frame from being bent inward in front, improvised spreader bars should

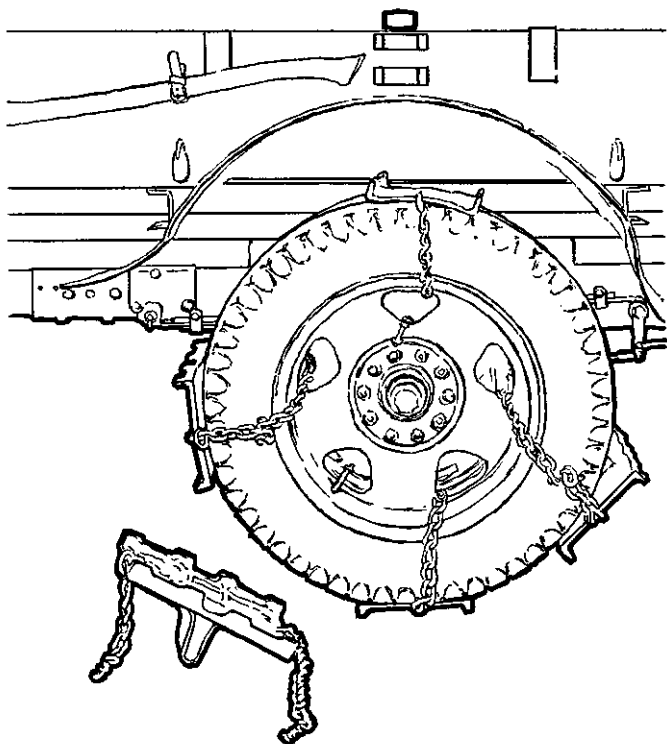

FIGURE 17.—Lug plate.

always be used to attach a cable or tow chain to both tow hooks.

■ 130. PROLONGES.—A prolonge is made from a piece of rope about 30 feet long by making a loop at one end. With this, man power or a tow from another vehicle may be most efficiently and quickly applied. A detail of men may drop a prolonge over a tow hook before a vehicle is completely stalled and help it past a difficult point. Tow ropes can most safely be attached to tow hooks, pintles, or around the spring shackle. Knots easily untied, such as the clove hitch with

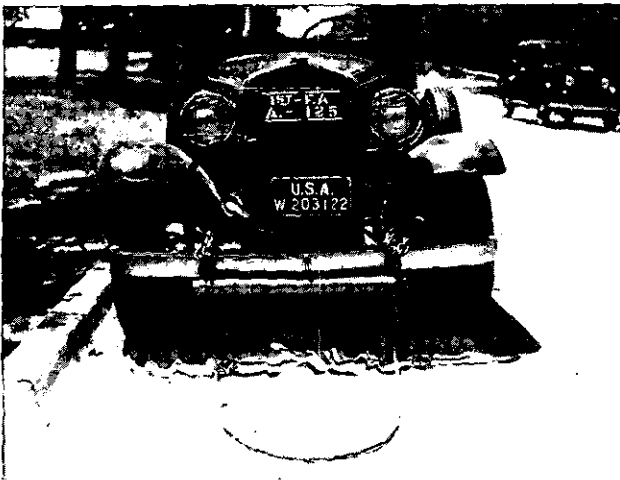
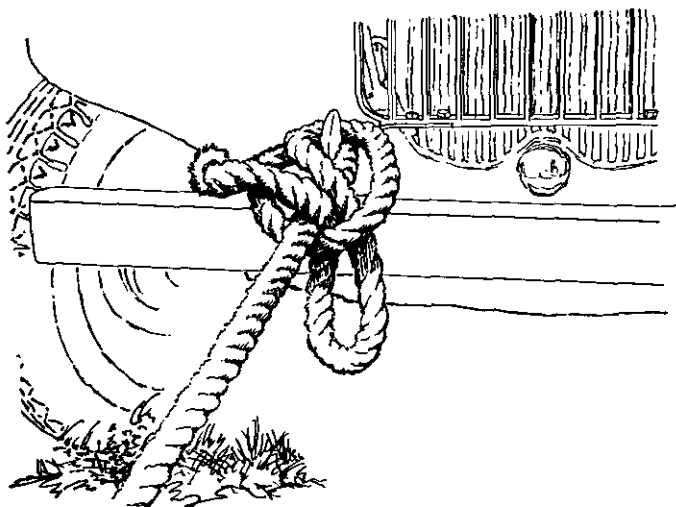
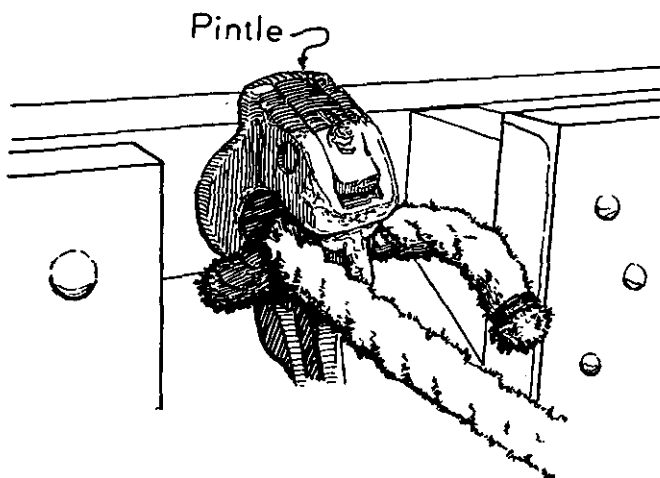

FIGURE 18.—Spreader bar.

end left through to form a bow, should be used. The double Blackwall knot for attachment to tow hooks and the single Blackwall knot for attachment to the pintle are the easiest to untie, but may occasionally slip. (Fig. 19.) A 1-inch rope will safely stand a tension of about one ton. Larger or smaller ropes increase or decrease in safe tension limits by 500 pounds for each  $\frac{1}{8}$ -inch difference in size from a 1-inch rope. The vehicle being towed should always assist with its own power.



① Clove hitch (end not pulled through).



② Single Blackwall knot.

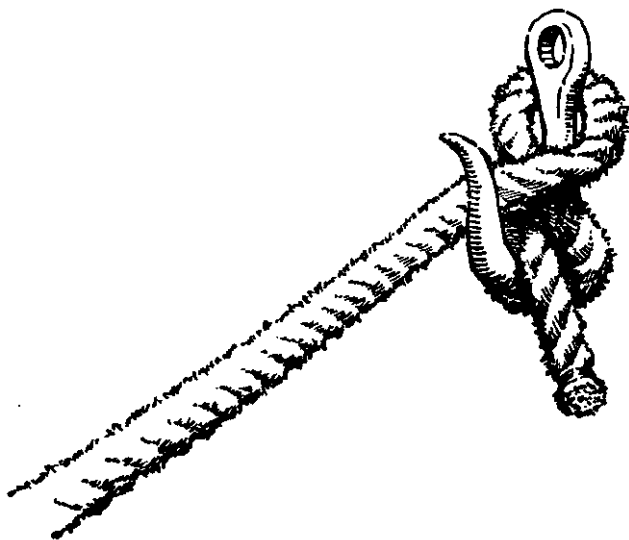

③ Double Blackwall knot.

FIGURE 19.—Knots.

■ 131. **BLOCK AND TACKLE.**—Where a winch truck is not available, a block and tackle is carried in the trouble truck. Attached to a tree, anchored stake, or deadman it is useful to multiply the towing power of either manpower or a towing vehicle.

■ 132. **TOWING BARS** (fig. 20).—Towing bars are used when a vehicle is to be towed.



FIGURE 20.—Towing bar.

■ 133. **A-FRAME** (fig. 21).—An A-frame is an expedient which combines both a lift and a tow. It is easily constructed with two poles approximately 12 feet long and two tow chains or cables. Holes are dug as supports for the foot of the frame,



or a cross chain or plank is used to prevent the poles from spreading. Care must be taken to place the A-frame far enough away from the towed vehicle so that, when it is lifted over, the foot of the legs will not damage the front of the vehicle. This simple device is a useful expedient when a wrecking crane or hoist attachment is not available to lift a vehicle out of and over a ditch or hole. It is also of use when a heavy vehicle is completely mired.

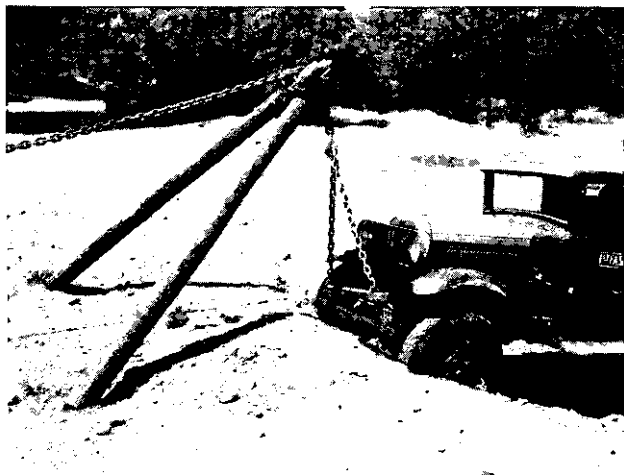

FIGURE 21.—A-frame.

■ 134. DEADMAN INSTALLATION (fig. 22).—The principle of installing a deadman is to utilize as much surface of undisturbed earth as possible and to prevent the tendency to rotate out of position. To get the best results the following points are essential:

*a. Position.*—A position for the deadman is best if chosen at least a yard behind a natural crest or mound. It should be far enough back so that it will not interfere with the vehicles clearing the obstacle and the attached cable or chain will not exert an upward pull.

*b. Digging.*—A hole is dug about 1 foot deep and long and wide enough for the deadman. The bank in the direction of pull is cut straight and is slanted away about  $15^\circ$  to the vertical. The bottom of the hole is cleared at a right angle to this bank. To assist in strengthening the top edge of the hole on the side in the direction of pull, two stakes are usually driven on either side of the cable at a slightly greater angle to the vertical than the bank. They are driven flush with the slanted bank near the top. A trench for the cable is cut from the hole through the crest of the hill or mound. This should be slightly deeper than the bottom of the hole at the beginning and should continue out in a descending slope.

*c. Cable attachment.*—A rectangular tie or larger timber of the type used for a wheel block is most suitable for the deadman, since it presents the maximum surface to oppose the direction of pull. The cable or chain is attached to the deadman so that the largest dimension is vertical and the pull on the cable is exerted along the bottom surface.

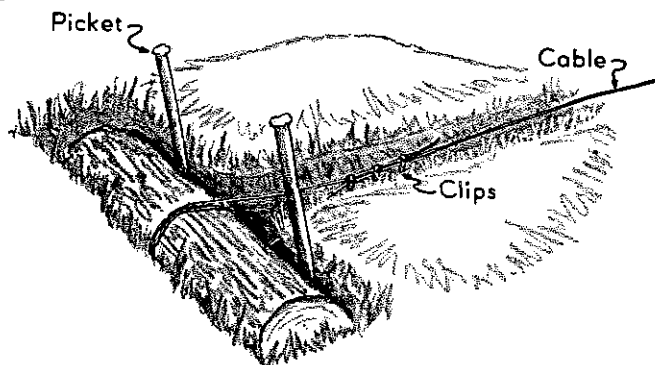

FIGURE 22.—Deadman.

■ 135. ANCHORED STAKE (fig. 23).—Two stakes and a rope lashing may be used to quickly install an anchored stake which will withstand considerable tension. The first stake is driven into the ground at a little greater than a right angle from the direction of pull. The second stake is driven at an angle slightly closer to the ground at 3 to 6 feet away from

the direction of pull. A rope is used to anchor the top of the first stake to the bottom of the second. In order that this rope will not slip down on the first stake, it is first tied to the bottom of the second, then wrapped over itself with a one-half clove hitch at the top of the first stake. The rope then is passed around the second and another half clove hitch is completed over the first, wrapping the rope around below the first hitch. This lashing is completed a number of times before the rope is secured to the second stake. A third stake may then be used to twist the lashing tight, after which it is driven into the ground.

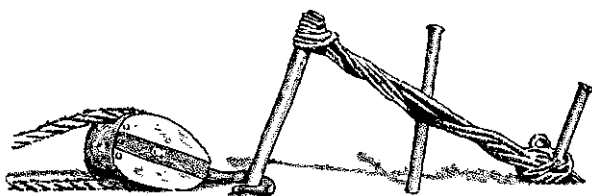

FIGURE 23.—Anchored stake.

■ 136. NIGHT-LIGHTING DEVICES.—*a.* Military vehicles should be equipped with night-lighting devices for use in night operation without lights. For those vehicles not so equipped, an improvised covering may be installed to permit only a dull glow of light.

*b.* Luminous paints which emit a faint glow in darkness may be used to replace night-lighting devices and may also be used on panels temporarily placed on the ground to guide a unit at night.

■ 137. MECHANICAL EXPEDIENTS.—The usual limitations for repair of the vehicle by the driver are stated in chapter 2. However, the following repairs can be made in the field in case of an emergency:

*a.* Broken spring leaves are splinted by means of strong pieces of wood or metal held in place with wire. One or several tent pins may be used. If necessary, a block of wood is secured between the frame and axle to prevent spring action. When necessary, displacement of the axle is prevented by running a wire around the front spring hanger and the axle.

b. When the light fuze is burned out, it may be temporarily replaced with tinfoil. This should be done only after the short in the system has been corrected.

c. A fan belt may be replaced with rope or the old one fastened together with wire. Friction tape may be wrapped around the belt to hold it in place.

d. When water has shorted the ignition system, it should be wiped away from the spark plugs. The wires should then be removed from the distributor head and wiped dry.

### SECTION III

#### DIFFICULT OPERATIONS

■ 138. POINTS TO BE OBSERVED.—In difficult operations the following points should be observed by officers and noncommissioned officers:

a. The column leader should have a good driver and a vehicle in good mechanical condition.

b. On approaching doubtful crossings or steep hills, a quick reconnaissance to determine the best route is made on foot ahead of the first vehicle.

c. Guards are dropped where drivers in rear should be cautioned.

d. While moving, a driver is given freedom in the operation of his vehicle within the limits prescribed by the commander to insure safe and efficient operation of the column.

e. When a vehicle is stalled, the driver must be given advice and help. A decision is required at once as to whether or not it can be moved by the next vehicle or by men at hand. If it cannot be moved without holding up the column, it is left for the crew with the trouble truck.

f. The column must be kept moving. When the road is blocked, a new route around is immediately found for other vehicles.

g. When the column comes to a halt, officers and section leaders should move forward to assist in carrying out the above principles.

■ 139. POWER, MOMENTUM, TRACTION, AND FLOTATION.—The ability of a motor vehicle to negotiate difficult terrain depends upon its power, momentum, traction, and flotation. A

Proper appreciation of these related factors will assist military personnel in the choice of a practical expedient to meet most road difficulties.

*a. Power* in any gasoline-propelled vehicle depends primarily upon maintaining sufficient engine speed. A shift to a lower gear allows the application of more power, but with a loss of forward momentum.

*b. Momentum* is the energy stored up by the weight in motion of the vehicle. It increases with the speed of the vehicle.

*c. Traction* is the maximum wheel or track thrust that may be applied to the ground surface without slipping.

*d. Flotation* is the ability of a wheel or track to ride the ground surface.

■ 140. ASCENDING STEEP SLOPES.—*a. Approaching normal hill.*—On approaching the usual hill, the leading driver should select a sufficiently low gear and proceed to the top without attempting to race his engine to keep up the normal rate of march. The driver of each succeeding vehicle closes up as the ascent begins and loses distance as the vehicle ahead picks up speed at the crest.

*b. Approaching difficult hill.*—Where the grade is slippery or the slope particularly steep, the leading driver on approaching the hill should select a sufficiently low gear and continue on to gain the maximum momentum which his load and the condition of the road permit. The driver of the next vehicle should slow up and halt before he arrives at the approach. He should wait long enough to see that the vehicle ahead has cleared the crest. The driver of each succeeding vehicle should close up, halt, and follow only after being certain that the vehicle ahead will negotiate the hill.

*c. Overcoming failure.*—On a steep ascent, stalling usually occurs because of either power or traction failure. Four solutions are presented: another run in a lower gear may be made, the load may be decreased or increased, traction devices may be added, or towing power may be applied.

(1) *Taking another run.*—If a driver has failed to give his vehicle the maximum momentum practical on the approach or if a shift has been made at the last moment in an effort

to increase the power, the driver is usually at fault. Another trial, with the maximum momentum practicable or with a lower gear ratio, may succeed.

(2) *Increasing or decreasing load.*—If power fails with maximum momentum and the lowest gear ratio, the load may be decreased. However, if failure is due to loss of traction and flotation is good, sufficient traction may be gained by increasing the load. This is usually done by loading men over the driving axle or axles. This solution will often be successful on vehicles with two-wheel drives, and on other vehicles not loaded but with heavy towed loads. On nontowing vehicles having front-wheel drives, the addition of more than the normal load is seldom advisable, because these vehicles will have sufficient traction to pull to the limit of their power.

(3) *Applying traction devices.*—If the road is soft or slippery, chains or other traction devices should be installed.

(4) *Applying towing power.*—Usually the most expeditious method of getting over a difficult ascent is to apply towing power, utilizing manpower, the winch, or another vehicle.

(a) If the hill or critical ascent is short, the use of man power applied through prolongs is usually the quickest and most practical method.

(b) If the hill is long and a winch truck is available, it should go up first and then pull the other vehicles over.

(c) If one truck can be pulled over, a long cable or chain may be used to connect each vehicle in turn so that each helps the next over the ascent.

(d) Towed loads may be disconnected and pulled up separately. If necessary, several vehicles may be connected in tandem to pull up a towed load.

*d. Failure precaution.*—As a precaution, when a vehicle stalls on a hill, the driver should not shift gears until he has tested the brakes by disengaging the clutch gradually. After the brakes have been tested and found to hold, the driver should shift to reverse and back the vehicle down the hill or to the side of the road in gear.

■ 141. DESCENDING STEEP SLOPES.—Descents should be approached similarly to ascents. The following principles should be observed:

*a. Choosing descent.*—Very steep slopes should be descended straight down, so that in case sliding occurs the vehicle will not get out of control. All personnel except the driver should be dismounted.

*b. Braking.*—Hills should always be descended in gear. The correct gear for the descent of a steep slope should be chosen during the approach and should not be changed until the bottom of the hill is reached. As a rule, the same gear is required in going down a hill as would be used in coming up the same hill. A sufficiently low gear should be selected so that the brakes need not be used. However, when necessary, brakes should be applied intermittently, being careful not to lock the wheels. In the descent of a hill, no attempt should be made to maintain the normal rate of march by racing the engine. *The ignition should not be turned off.*

*c. Assistance.*—Outside assistance should be given to vehicles descending steep slopes. It may be applied as follows:

(1) By manpower through the use of prolonges or block and tackle. A rope may often be snubbed around a tree or post.

(2) By use of another vehicle on top of the hill, moving forward in lowest gear, connected by chain, cable, or rope to the vehicle descending.

(3) By use of the winch, the cable being run out in gear, the descending truck operating in the lowest gear.

(4) By setting brakes on towed loads and attaching a safety rope or tackle. When necessary, towed loads should be disconnected and let down separately.

■ 142. MUDDY ROADS.—The usual muddy road that will be encountered is soft and slippery on the surface, while underneath it is generally hard or will pack sufficiently to support a vehicle. Soft spots will allow spinning wheels to quickly dig in. The following principles are applicable to negotiating this type of muddy going:

*a. Traction aids.*—Chains usually give the best aid to traction and prevent skidding.

*b. Gear.*—In general, the highest gear that will give sufficient power is selected. As the loss of momentum and the

sudden application of increased power at a critical point start the wheels to spin, the need for a gear reduction must be anticipated.

*c. Momentum.*—Momentum should be maintained across slippery places and up grades. Usually when slipping occurs, the speed of engine should immediately be decreased so that the wheels can take hold.

*d. Choice of track.*—Old ruts are the hardest packed and should generally be chosen. This principle usually holds for all vehicles following. The exception to this rule is covered in paragraph 143. Where road centers are high, ruts should be straddled or a new track should be made.

*e. Procedure on stalling.*—Once a vehicle has come to a complete stall in mud, the clutch is disengaged at once. No new trial is attempted until an outside check-up is made. Proper procedure for quickly extricating a stalled vehicle is dependent upon judgment and experience. The following possibilities are suggested:

(1) *Dismounting personnel.*—If personnel are carried, they should dismount and try to push the vehicle out. Often the lightened load and this applied power will be sufficient. In making a try with outside aid, the driver should apply power to the wheels gradually by easing in the clutch. This trial should not be continued to such an extent that the wheels dig in.

(2) *Selecting best way out.*—Usually a vehicle can be moved backward for a new trial easier than it can be moved forward.

(3) *Use of manpower.*—If prolonges and sufficient men are available, an immediate attempt should be made to move the vehicle by manpower.

(4) *Applying nearest suitable tow.*—If a light tow will probably succeed, the next suitable vehicle ahead or behind may be used. Often the next vehicle can be detoured and used for a tow. Where the vehicle has slid off a highly crowned road, men with prolonges attached to the sides may assist in helping the vehicle back onto the road.

*f. Stalled vehicle.*—(1) Where the vehicle is found to be hopelessly stalled, a winch, tractor, vehicles in tandem, or a block and tackle must be used.



(2) Where a vehicle operating alone becomes stalled in mud, the driver and any personnel that may be with him are dependent on one of the following methods of extricating it:

(a) *Improving traction.*—Any additional traction devices such as wheel mats, lug plates, or grouser ropes may be applied. Often one or more drive wheels must be jacked up and traction and flotation increased by placing brush, boards, rocks, or similar material under the wheels. When possible, a pole used as a lever inserted under the hub or in place of the wheel cap is the easiest method of raising the wheels.

(b) *Digging out.*—Ditches dug in the direction that the wheels are expected to move assist in moving the vehicle out. When wheels are in deep ruts, usually cross ditches dug at an angle to the ruts with dirt thrown into the ruts are necessary to carry the wheels back on to a straddle position over the rut.

(c) *Windlass method.*—The windlass method of having a dual-wheel truck pull itself out of a bad mud hole is simple and rather certain of success. A single long cable with loops on each end, or two tow cables, and four stakes are required. The vehicle may be pulled out either backward or forward. Two anchored stakes are installed on the bank at the same distance apart as the wheels and directly in front of or behind the vehicle. The loop ends of the cables are taken in between the tires of each dual wheel and secured by passing the loop between the spokes and over the hub. The cables are then attached to the anchor stakes. The vehicle is then pulled out on its own power by allowing the cable to wind up between the dual wheels whenever slipping occurs.

(d) *Pole method.*—A similar principle may sometimes be applied by inserting a pole as a track between the dual wheels that are slipping. This method may be made more efficient with track-laying vehicles by attaching the pole to the track. The vehicle is rolled over it and the attachment is removed before strain is placed on the track.

**CAUTION:** Because of the danger of slipping under the vehicle, personnel should be cautioned against pushing on the side of a moving vehicle that has slipped into the ditch from a high crown road or on a vehicle that has slipped into old wheel ruts.

■ 143. SWAMPY OR BOGGY GROUND.—Where water has been standing for a considerable time and swamp grass has grown, a surface crust has formed on top of a bottomless soil. Certain variations in principles and procedure apply in this exceptional type of muddy going.

*a. Avoiding swamps.*—Boggy or swampy soil may usually be avoided. Every effort should be made to move over the highest ground available.

*b. Traction devices.*—The addition of dual wheels in front, traction bands, and any other aids which increase the wheel surface in contact with the ground are a distinct advantage.

*c. Personnel dismount.*—Personnel should dismount and assist with prolongs at critical points.

*d. Maintaining momentum.*—The main requirement in moving over a boggy piece of ground is to move over it rapidly without stopping. Wheel spinning should be kept at a minimum.

*e. New tracks selected.*—The grassy crust may carry one vehicle but may not support another in the same track. Therefore each vehicle should follow a separate track. A guide should precede each vehicle on foot, locating the hard ground and guiding the driver carefully over the best route.

*f. Stalling.*—When a vehicle comes to a traction stall, the clutch should be disengaged at once. No attempt should ever be made to move it without outside power.

*g. Towed loads.*—To pull towed loads, several trucks may sometimes be hooked in tandem; or they may be pulled abreast, with the towed load attached by a pulley sliding on a cable between the two trucks.

■ 144. GUMBO AND OTHER STICKY SOILS.—Gumbo and other sticky soils present a problem similar to that of boggy ground. In addition these soils give little traction and stick to the tires and wheels in great masses. Boards, shovels, knives, and the like may be fastened to cut the mud from the wheels. Whenever possible, old, hard-packed roads should be selected through these areas.

■ 145. PASSING THROUGH SAND.—Flotation in sand increases more or less below the surface. Usually sand will support a vehicle moving rapidly. However, traction is very limited because wheels are continually slipping. As soon as a drive

wheel begins to spin it digs in fast. Although the difficulties in passing through sand vary between those described in paragraphs 142 and 143, several additional principles are possible in overcoming traction failures in sand:

*a. Increasing tire surface.*—In exceptional circumstances air pressure may be decreased in the tires to give sufficient flotation.

*b. Digging vehicle out.*—When the sand is somewhat encrusted below the surface, the vehicle will continue to creep while the wheels spin. As long as the vehicle continues to move, the wheels may be kept slowly spinning, allowing the vehicle to dig itself out.

*c. Using same track.*—In order to reduce road friction, vehicles should follow exactly the tracks of the vehicle ahead.

*d. Making roads.*—Hog or chicken wire fencing staked on the surface of sand will usually make a satisfactory surface for movement of motor vehicles.

■ 146. DRIVING ON SNOW AND ICE.—On soft snow flotation is at a minimum, while on ice traction is at a minimum. In addition to many of the principles already listed in paragraph 142, the following are applicable to winter driving:

*a. Traction aids.*—Chains on all wheels are usually the best safeguard in normal winter driving. However, on ice they add little or no traction and are apt to give a false feeling of security, because they increase skidding.

*b. Moving over fresh snow.*—When breaking freshly fallen snow, manpower should be readily available to push the first vehicle or to tow it with prolonges where the snow is deep. Other vehicles, following exactly in track, usually move under their own power if they are able to gain momentum in approaching difficult slopes and crossings.

*c. Braking.*—The engine should be used as a brake. The driver shifts to a lower gear when more braking power is needed. When used, brakes should be applied lightly and released quickly if skidding begins.

*d. Accelerating.*—Rapid acceleration should not be attempted, as it may cause one drive wheel to spin, thus losing traction or causing skidding.

*e. Overcoming skidding.*—If skidding occurs, the brake or clutch should not be touched. The accelerator should gradually be released. The front wheels are turned in the same direction the hind wheels are skidding, so that the vehicle will be carried forward with momentum in a straight line parallel to its original path.

*f. Holding vehicles on road.*—Where necessary, men with prolonges may hold vehicles on dangerous icy roads.

■ 147. CROSSING DITCHES AND DEEP RAVINES.—*a. Narrow or shallow ditches.*—Ditches in width up to nearly the diameter of the tire and wider shallow ditches should always be traversed at an angle, so that the drive wheel on one side will take hold of the far edge of the ditch at the same time that the opposite wheel is going into it. As this angle of crossing is a severe strain on the frame, springs, and driving mechanism, personnel should be dismounted to assist by pushing at the critical point. Ditches must be crossed slowly.

*b. Wide ditches or ravines.*—When a ditch is wider than the diameter of the tire and deeper than the running board or undercarriage clearance, no attempt should be made to pass it until the banks are thrown in and the bottom filled up. Such ditches should be crossed at right angles. If they are wet, they should be approached slowly and the vehicle speeded up without wheel slipping just as the front wheels cross the lowest point.

■ 148. FORDING SHALLOW STREAMS.—Fordings should be attempted only after careful reconnaissance. The following points are to be observed:

*a. Cross slowly.*—As a rule nothing is to be gained by attempting to use momentum in crossing streams. They should be crossed slowly in a low gear.

*b. Disconnect fan.*—If there is any danger of the water surging or splashing to the fan, it should be disconnected for the crossing, usually by loosening a bolt and raising the generator.

*c. Dry brakes.*—After crossing a stream brakes should be applied intermittently until dry enough to hold.

*d. Check lubrication.*—At the first opportunity wheels, crankcase, universal joint, differential, transmission, and sub-transmission should be checked for proper lubrication.

■ 149. DEEP-STREAM CROSSINGS.—When the situation demands that streams too deep for fording be crossed, the first consideration should be to obtain ponton bridges, bridging materials, ferries, or rafts. However, even if none of these are available, motor vehicles can be taken across streams of almost any depth without serious damage if suitable precautions are taken. The tackle and tow indicated in figure 24 are used. The vehicle must be properly prepared for submersion by closing all openings and removing such parts as will be seriously harmed or rendered inoperative by moisture. After crossing, the vehicle should be thoroughly serviced and water removed from units.

■ 150. BRIDGES.—Speed caution signs should be carefully observed, as well as the signs showing maximum capacity. When the capacity of a bridge is not sufficient, the towed load should be pulled across separately. Track-laying vehicles should be started across a bridge so that they will not have to be turned, because steering them places a severe strain on the bridge.

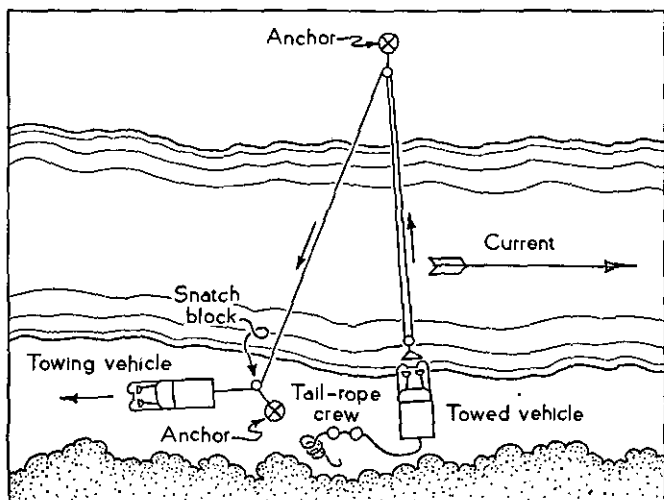

FIGURE 24.—Tackle for deep stream crossing.

■ 151. DRIVING ON CURVES.—Skidding on slippery curves is avoided by a reduction of speed before the vehicle goes into the turn. The importance of this consideration depends upon two factors:

a. Centrifugal force, which tends to throw a vehicle to the outside of a curve, varies as the square of the speed.

b. When the brakes are applied the weight of the load is shifted from the rear wheels to the front wheels, reducing the traction on the rear wheels and increasing the tendency to skid. When the brakes on a towed load are not applied, the tendency to skid is increased.

■ 152. NEGOTIATING TURNS WITH A TOWED LOAD.—If a curve is too sharp for a truck and towed load, it is usually possible to

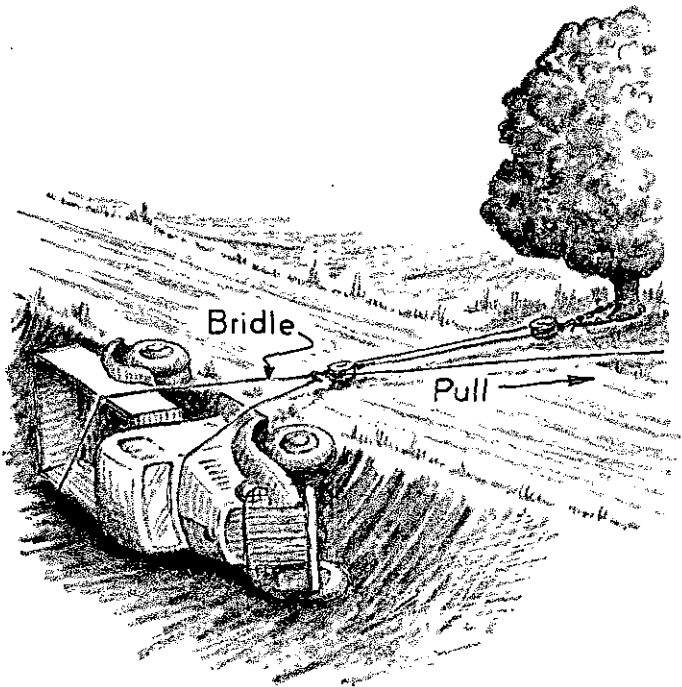

FIGURE 25.—Righting an overturned vehicle.

uncouple the truck and drive it around the turn, and then by use of a tow cable or block and tackle to pull the towed load around the turn.

■ 153. RIGHTING AN OVERTURNED VEHICLE (fig. 25).—In order to get a maximum leverage on an overturned vehicle, a cradle of two ropes should be passed over the body of the vehicle, one in front of the windshield and the other in rear of the center of the vehicle. Both should preferably be tied to the body frame or spring shackle. Brakes should be applied before the vehicle is righted. Any of the towing means may be used on the ropes. Holding lines should be used to prevent damage to the vehicle from settling too rapidly. Before the vehicle is moved under its own power necessary oil and gas, battery and radiator water should be replaced, and a careful inspection should be made to determine the damage done.

## CHAPTER 5

### MILITARY AUTOMOTIVE MAINTENANCE

SECTION	Paragraphs
I. General.....	154
II. Echelons of maintenance.....	155-159
III. Maintenance operations.....	160-163
IV. March maintenance.....	164-169
V. Lubrication.....	170-175
VI. Inspections.....	176-179
VII. Records and reports.....	180-182

## SECTION I

## GENERAL

■ 154. BASIC PRINCIPLES.—*a.* The Army system of automotive maintenance is based on—

(1) Scheduled preventive maintenance operations, unit replacements, repairs, and inspections with the primary objective of economical, uninterrupted vehicle service.

(2) Systematic detection and correction of incipient causes of vehicle casualties before they occur and the operations necessary to maintain satisfactory day-to-day operating condition of motor vehicles.

*b.* The principle of unit replacement rather than major repair of a unit while installed in the vehicle is practiced in all cases where such assembly is available. Where minor repair only is required and can be made without dismantling the unit or removing the unit from the vehicle, the unit replacement principle is not followed. When an unserviceable unit is removed it is subjected to an operation termed unit major repair, requiring dismantling and rebuilding of the unit. The rebuilt unit is rendered available as an exchange unit assembly.

*c.* Within the motor maintenance system of operating organizations will be included only the tools, equipment, and personnel which are necessary to insure combat efficiency. It will be predicated upon—

(1) Close and adequate support by the supply service motor maintenance units.

(2) Meeting the normal needs of operation (not the unusual needs).

(3) Minimum decentralization within the regiment.

(4) The expectation of a certain proportion of motor-vehicle casualties. The available elements essential to maintenance will determine in each case whether these casualties will be repaired by the organization or by the supporting service.

(5) Replacement of vehicles which cannot be repaired within the time element in the particular situation.

*d.* The necessity for economy in peacetime affects all phases of motor vehicle maintenance in garrison service, but this



necessity must not be allowed to obscure the proper conception of field maintenance. Care must be exercised by all personnel to retain the distinction between the proper functions and scope of the motor maintenance of operating organizations and those of the supporting services under field conditions, and to avoid the error of carrying into the field the scope of maintenance imposed by economy requirements in garrison. In addition, sufficient training in garrison will be conducted, using only the motor maintenance equipment which will be available in the field to keep the field motor maintenance upon a high plane of efficiency.

## SECTION II

### ECHELONS OF MAINTENANCE

■ 155. GENERAL.—There are, in general, four divisions of Army maintenance called the first, second, third, and fourth echelons (AR 850-15).

*a. Responsibility.*—The first and second echelons of maintenance are the responsibility of the using arms and services, while the third and fourth echelons are the responsibility of the supply services.

*b. Essential elements.*—There are four elements essential to maintenance functions: Personnel, equipment, supplies, and time. The work to be performed in the various echelons is limited by restrictions of one or more of these elements.

*c. Functioning.*—The succeeding paragraphs of this section are devoted to the detailed functioning of the first and second echelons and to a broad presentation of the third and fourth echelons.

■ 156. FIRST ECHELON—DRIVER AND ASSISTANT DRIVER.—The first echelon maintenance is drivers' maintenance. It covers the simple operations that can be trusted to the skill of the average driver using tools and supplies available on the vehicle. These operations may include: Drivers' inspections; servicing (replenishment of gasoline, oil, water, antifreeze, and air); cleaning, lubrication, except items requiring special lubricants, equipment, or technical knowledge; tightening or replacement of nuts, bolts, screws, and studs; preparation of the vehicle for maintenance operations and for command

and technical inspections; and care of tools and equipment of the vehicle to include the storage battery. Further details under first echelon maintenance are discussed in chapter 2.

■ 157. **SECOND ECHELON.**—The second echelon maintenance is that maintenance other than first echelon maintenance performed by the using arms and services. It embraces preventive maintenance, minor repairs, unit replacements, and inspections within the limits of time available. When vehicles are pooled or are in one special organization, the first and all the second echelon functions are combined. On the other hand when a company or battery of a regiment has vehicles assigned to it, the second echelon functions are usually divided between the company or battery and the regiment. The organization to which the vehicles are assigned is responsible for first echelon maintenance and certain portions of the second echelon, limited as hereafter provided, by the tools, light portable equipment, parts, and mechanics authorized. The regiment, on the other hand, with its separate maintenance section, performs the operations requiring either more skill or special tools.

*a. Company or battery.*—(1) *Unit commander.*—The unit commander is directly responsible for the first and part of or all the second echelon maintenance. He normally has the assistance of a motor officer, a motor sergeant, and motor mechanics. The success of preventive maintenance will depend upon the judgment, energy, common sense, and ability not only of that unit commander but also of his subordinates. The state of training, discipline, and morale of the latter also will have a direct bearing upon operating efficiency. In order to insure a high state of operating efficiency the unit commander must—

(a) Separate, so far as possible, the operating and maintenance functions of his personnel and establish definite responsibility for each function.

(b) Establish and maintain uniformly high standards for all work.

(c) Make vehicles available for maintenance operations.

(d) Enforce a simple but thorough method of record keeping.

(e) Conduct schools to insure uniform training of drivers and mechanics, and to supply replacements for personnel losses.

(f) Provide necessary lubrication, maintenance, and inspection guides.

(g) Establish and enforce routine scheduled maintenance operations.

(h) Make such inspections as are necessary to insure the proper coordination and functioning of all personnel.

Maintenance is a function of command. Continued successful operation by a motorized unit requires that the personnel in command positions give to the activities of maintenance the time and effort necessary to meet the needs of operation. Unusual operating efforts require unusual maintenance efforts if the command is to retain its efficiency in movement. Although a unit commander may properly delegate authority to his motor officer, considerable active, personal control is necessary to maintain any group of vehicles in a high state of operating efficiency. In unusual conditions provision should be made to divide the work into shifts, so that the maintenance personnel may have an opportunity for rest. A practical division of duties and responsibility is given below:

(2) *Motor officer.*—The motor officer should be selected from those officers having either special motor training or aptitude. He should be familiar with all the peculiarities of his vehicles and should be able to inform his seniors at any time of the exact condition of each vehicle. He is responsible to his immediate commander for the technical operation and maintenance of the vehicles. His duties include—

(a) Organizing and supervising the maintenance, repair, and servicing of vehicles.

(b) Instructing the drivers and assistants until they are fully qualified.

(c) Being in charge of all caretaking.

(d) Inspecting before leaving park, on the road, at the halt, at the end of the march; inspecting vehicles in storage; and making maintenance inspections.

ORGANIZATION WITHIN THE COMPANY OR BATTERY FOR  
SECOND ECHELON MAINTENANCE

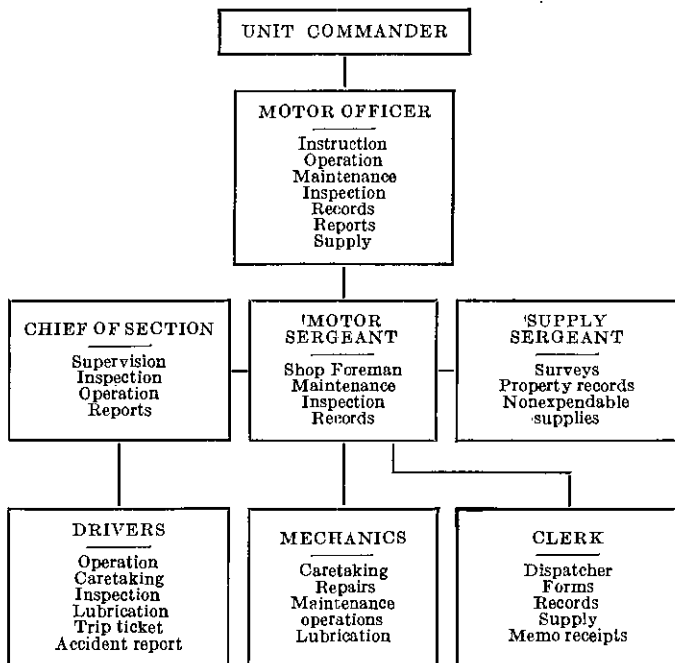

- (e) Assisting in making command inspections.
- (f) Seeing that all parts and supplies are procured.
- (g) Routing vehicles to a higher echelon.
- (h) Supervising the keeping of forms and records.
- (i) Instructing all maintenance personnel in their duties.
- (j) Spot checking all maintenance operations.
- (k) Carefully watching the lubrication services and checking the lubricants for type and condition.
- (l) Having all fire hazards removed.
- (m) Observing the drivers, whenever practical.
- (n) Directing the transfer of loads in case of break-down.

(o) Giving proper instruction in case any personnel is left behind on a march.

(p) Giving proper instructions to expedite any road repair or rescue.

(q) Riding usually at the tail of the column.

(3) *Motor sergeant*.—The motor sergeant should be selected for his knowledge, mechanical skill, and his aptitude for organization and supervision. He allots the work to mechanics and inspects their work both during the actual performance and when the job is completed. He should be well versed in quickly and accurately diagnosing mechanical failures and should be able to give the mechanics proper instructions for corrective action. He should be trained in field expedients and should be able to get the vehicles through when stalled or in bad going. He should be present with the vehicles from the time of the arrival of the first driver until the last vehicle is in, and he should remain with them until they are all ready to operate again. His duties include—

(a) Principal assistant to motor officer.

(b) Direct charge of the park.

(c) Directing the work of mechanics and, if so assigned, the drivers.

(d) Closely supervising and checking the work of mechanics in scheduled maintenance.

(e) Assisting, as directed, in inspections.

(f) Observing operation of vehicles on the march, and supervising road adjustments, repairs, and rescues of stalled vehicles.

(g) Personally checking or designating a mechanic to check all vehicles immediately upon any halt and upon completion of the day's march. Particular attention is paid to excessively heated parts, such as gears and brakes.

(h) Reporting evidences of neglect, abuse, or carelessness to the motor officer.

(i) Keeping or supervising the keeping of the record of repairs, adjustments, fuel, and supplies.

(j) Supervising starting of engines to see that they start promptly and are warmed up properly.

(k) Riding usually at the tail of the column.

(4) *Chiefs of sections.*—Chiefs of section direct the march of their sections and require drivers to comply with instructions as to gear, speed, distances, safety, and similar matters. Their duties include—

(a) Responsibility for and directing caretaking by drivers.

(b) Reporting vehicle troubles and faults to the motor sergeant.

(c) Responsibility for the replenishment of gasoline, oil, water, and other operating supplies.

(d) Riding usually in the first vehicle of the section.

(5) *Mechanics.*—The number of mechanics allotted to the various units is given in the Tables of Organization. It is based on the number of vehicles to be maintained. Mechanics make repairs and adjustments under the direction of the motor sergeant. They perform the operations of scheduled maintenance, assist chiefs of section in caretaking when so detailed, and observe vehicles on the march. One mechanic usually rides with the motor officer and the others ride in the unit repair truck.

(6) *Tools and equipment.*—The Tables of Basic Allowances prescribe the tools and equipment. For each general automobile mechanic the allowance is one set of hand tools consisting of about fifty items. Included are a canvas tool bag; box end, engineer, pipe, socket, and crescent wrenches; hammers; punches; screwdrivers; files; drifts; feeler gauge; chisels; pliers; and several other items. This set is issued to each mechanic on memorandum receipt from the unit supply sergeant; the mechanic should carry his set of hand tools with him wherever he is required to ride. In addition to the tool sets of the mechanics, the motorized battery, company, or similar unit is allowed a "unit equipment set." Other "unit equipment sets" are available for issue to second echelon units if provided for in the Tables of Basic Allowances. A "mechanic's truck" or repair truck is usually allotted to each unit for carrying mechanics, tools and equipment, and parts and operating supplies.

(7) *Spare parts and supplies.*—In order to prevent the dissipation of spare units and parts, the stock is generally limited to that required for the discharge of necessary mainte-

nance functions. The stock required will vary with the number, makes, and types of vehicles as well as with the conditions of operation, such as cold, dust, sand, and mud. Parts and supplies of the following type are usually stocked and carried: Spark plugs, condensers, fuzes, lamps, fan belts, ignition cable, radiator hose and clamps, miscellaneous gaskets, gas and oil lines and fittings, battery cables, lubrication fittings, water-pump packing, gas tank and radiator caps, and assorted hardware, to include bolts, nuts, washers, pins, and screws.

*b. Regiment.*—In most arms and services there is provided by the Tables of Organization a regimental second echelon maintenance organization. The personnel are a part of the headquarters company, battery, or like unit of the regiment and are administered by the commanding officer of that unit. The regimental commander is directly responsible for the operation of the regimental second echelon. If a regimental motor officer is not provided for by the Tables of Organization, the regimental commander should designate a staff officer or other qualified officer to act as such. Normally the Tables of Organization provide a regimental motor officer, regimental motor sergeant and assistant, motor supply personnel, general automobile mechanics, and a clerk. When all the vehicles of the regiment are physically pooled and all maintenance functions are performed by the regimental second echelon, additional personnel, such as dispatcher, truck masters, and extra mechanics, will normally be provided. The organization is generally such that the personnel as well as tools, equipment, and supplies are readily decentralized into battalion sections in case such decentralization becomes necessary.

(1) *Regimental motor officer.*—The regimental motor officer must be a highly trained full-time motor officer to command the motor-maintenance personnel and supervise its functions. When all or part of the maintenance is decentralized to the battery, company, or similar unit, technical supervision of this maintenance personnel by the regimental motor officer is a prime requisite. Although each unit commander is responsible for his own vehicles and personnel, the regimental commander can expect a uniformly high stand-

ard of operation and maintenance throughout his regiment only by exerting close technical supervision. The regimental motor officer as a representative of the regimental commander must be cooperative and diplomatic with the subordinate unit commanders. He must instill a feeling of assistance and cooperation and must be careful to avoid assuming command of the unit maintenance personnel. He must furnish technical information to the units. Such information will normally be given in the form of guides for maintenance and lubrication operations as well as through informal meetings and schools with all maintenance personnel of the regiment in attendance. The regimental motor officer checks on maintenance of the units by calling without prior notice for designated vehicles from the units for maintenance operations and maintenance inspections. Information thus obtained, together with general observation of vehicles brought in for routine repair and observation of the organization maintenance personnel while at work, will indicate the quality of maintenance being performed by each unit. Where unsatisfactory maintenance is observed, the regimental motor officer will inform the unit commander concerned and make recommendations for correction. When improvement cannot be obtained through this method, report should be made to the regimental commander. His duties include—

(a) Being in charge of the regimental motor maintenance section or platoon.

(b) Coordinating and consolidating all requests for third echelon repairs. Cooperating with third echelon shops on requirements for repairs.

(c) Supervising replacements and maintenance operations.

(d) Making maintenance inspections as required.

(e) Supervising the keeping of motor-vehicle operation and maintenance records.

(f) Coordinating and consolidating all requisitions for motor transport parts and supplies, other than those handled by the unit supply officer.

(g) Supervising the supply and issue of motor transport supplies within the regiment, other than those handled by the unit supply officer.



- (h) Keeping a record of expenditure of funds allotted.
- (i) Checking upon the units to prevent the hoarding of parts and supplies to the detriment of other units.
- (j) Prorating the budget allowance in money value for cleaning and preserving material and parts, as directed by regimental commander.
- (k) Keeping in touch with all maintenance establishments that operate with the organization.
- (l) Preparing all records and reports in regard to motor transportation required to be forwarded to higher headquarters.
- (m) Supervising the unit motor schools.
- (n) Keeping in touch with the utilization and circulation of vehicles of the units.
- (o) Assisting the commanding officer in making command inspections.
- (p) Notifying all organizations of the location of his repair facilities in the field.
- (q) Riding at the tail of the column, ordinarily allowing none to fall behind him, except those vehicles beyond repair. In time of peace he makes suitable arrangements for repair or salvage of vehicles so damaged that towing is not practicable.
- (r) Examining driver candidates, and keeping record of and issuing W. D., Q. M. C. Form No. 228 (U. S. Army Motor Vehicle Operator's Permit), in accordance with AR 850-15.
- (s) Preparing scheduled maintenance guides for the various units under his technical supervision, as well as for the regimental maintenance section's operation.
- (t) Keeping unit commanders informed as to the efficiency of maintenance of their motor vehicles.
- (u) Insuring that information issued in technical service bulletins or regulations reaches all maintenance personnel in the regiment.
- (v) Making frequent visits to the unit motor maintenance personnel to render such assistance and advice as may be needed.

(2) *Regimental motor sergeant.*—The regimental motor sergeant is the principal assistant of the regimental motor

officer. He is in direct charge of the mechanics and assigns and supervises their work. He coordinates the duties of the supply personnel with those of the maintenance personnel. He prepares the maintenance records and reports required. In the absence of the regimental motor officer, he takes over his duties, establishes the maintenance set-up in the field, and notifies all organizations of his location.

(3) *Regimental motor mechanics.*—The regimental motor mechanics should be among the best qualified mechanics in the regiment, thus making the services of the best mechanics available to all units.

(4) *Regimental supply officer.*—The regimental supply officer is directly charged with the procurement and issue of fuel, lubricants, antifreeze solutions, cleaning and preserving materials, and similar items directly to the operating units. He should utilize the services of the regimental motor officer in preparing recommendations as to the quantity and quality of operating supplies and the quantity of maintenance supplies. The duties of the regimental motor officer in no way change the duties and responsibilities of the regimental supply officer.

(5) *Tools and equipment.*—Tools and equipment allotted regimental maintenance units are prescribed in the Tables of Basic Allowances. Each mechanic is allotted a set of hand tools of the same type as are furnished company or battery mechanics. Each regimental section or platoon is allowed one or more "unit equipment sets." In general, these sets include the same items as are allowed the battery, company, or similar unit, plus tools and equipment for more extensive and technical operations.

(6) *Spare parts and supplies.*—The bulk of the spare units, parts, and supplies for the entire regiment is carried in the regimental section or platoon. This prevents dissipation of the stock available and yet allows any portion of it to be readily available to the organizations. The stock required will vary with the number, makes, and types of vehicles, as well as with the conditions of operation. The supply of parts, units, and supplies requires careful planning and close cooperation with the supply agencies to insure the prompt service necessary for efficient operation.

Ordinarily an unserviceable unit is replaced by a spare unit, if one is available, and the damaged unit is then returned by the regiment to the third echelon for exchange. The authorized stock of maintenance and operating supplies should at all times be available in the second echelon. In addition to the parts and supplies usually carried in the battery, company, or similar unit maintenance establishments, the regimental maintenance platoon carries accessory assemblies and certain other high-mortality parts.

■ 158. **THIRD ECHELON.**—Third echelon maintenance is that normally performed in the field by quartermaster and ordnance personnel. It embraces principally the replacement of unserviceable unit assemblies by similar unit assemblies held in third echelon stock. Unit replacement will be practiced in all cases, unless it is unmistakably obvious that a minor repair or replacement of a subunit assembly or part is all that is required, that this repair or replacement can be made without removal of the unit assembly from the vehicle or without disassembly of the unit, and that the supplies required are on hand or are quickly and readily obtainable. In addition to unit replacement, the third echelon supports and extends maintenance facilities to the using arms and services by making repairs involving the use of medium mobile shop equipment and by the services of general mechanics and a limited number of trade specialists; by the supply of unit assemblies and parts to the second echelon; and by the evacuation to the third and fourth echelon shops of vehicles which require repairs beyond the scope of second and third echelon facilities. The third echelon shop normally is located out of range of hostile medium artillery but not farther than 10 miles from the front line, near routes of ingress and egress, and with suitable parking space. In the division, the third echelon shop is established by the light maintenance company of the quartermaster regiment for vehicles issued by the Quartermaster Corps. It is organized and equipped to provide immediate decentralized support to motorized organizations so situated as to require special support.

■ 159. **FOURTH ECHELON.**—The fourth echelon maintenance is that normally performed in the rear areas by the quartermaster or ordnance personnel. It embraces the tear-down

and repair of any or all unit assemblies which are used in the motor vehicles of the command to which the fourth echelon shop is assigned. Essentially this consists of major unit repair. It also includes salvage and reclamation service.

### SECTION III

#### MAINTENANCE OPERATIONS

■ 160. DEFINITIONS.—*a. Repairs.*—Repair consists of adjusting, tightening, replacing, or reconditioning any part, subassembly, or assembly of a motor vehicle.

*b. Adjustments.*—Adjustment consists of placing parts, subassemblies, or assemblies in correct working relation to each other and securing them in that position. Examples of adjustments are wheel bearing clearance, fan-belt tension, spring-shackle tension, breaker-point clearance, brake clearance, and clutch-pedal clearance.

*c. Tightening.*—Tightening consists of drawing up nuts and screws where adjustment is not involved. Examples of parts to be tightened are body bolts, body screws, bumper bolts, fender and running-board nuts, and floor-board bolts or screws. This is usually the duty of the driver; therefore, a clear distinction should be made between tightening and adjusting. The latter requires knowledge, experience, and often special tools and is usually performed by fully qualified repair personnel.

*d. Replacing.*—Replacing consists of exchanging any part, subassembly, or assembly, and placing them in proper adjustment. Examples of parts which may be replaced are distributor heads, oil and gas lines, radiator hose, mufflers, oil filters, brake parts, carburetors, generators, batteries, and transmissions.

*e. Reconditioning.*—Reconditioning consists of restoring any part, subassembly, or assembly to a state of serviceability. Examples of reconditioning are turning down armatures, re-facing valves, welding broken parts, patching tubes, and re-boring cylinders.

■ 161. SCHEDULED OPERATIONS.—In order to maintain the vehicles in as near perfect operating condition as possible, scheduled maintenance operations followed by maintenance

inspections are necessary. These should be positive operations performed in accordance with a definite schedule based on time, mileage, or a combination of both. This schedule must be planned well in advance and coordinated with anticipated demands for vehicles. Maintenance personnel should have available for their use a guide for the various maintenance operations modified to meet the requirements of different types and makes of vehicles or particular operating conditions. Scheduled maintenance operations for all vehicles, except those special purpose and combat vehicles for which maintenance operations are prescribed in service manuals and handbooks, are divided into five general classifications as follows:

*a. Daily.*—Daily maintenance consists of cleaning, servicing, tightening, and emergency repairs. Cleaning, servicing, and tightening are duties of the driver under the direct supervision of the chief of section and under the technical supervision of the motor maintenance personnel. In general, the daily repairs will be of an emergency nature or will be based upon defects reported on the drivers' daily trip tickets and the reports of supervisory personnel. After an examination of these reports the work will be allotted to the various mechanics according to their ability, or it will be sent to the regimental or higher echelon shop. Except in an emergency, a vehicle will not be dispatched for work before the defects are corrected.

*b. Weekly.*—Weekly maintenance is a continuation and a check of the drivers' daily maintenance. It will be performed at least once each week by the driver under the direct supervision of the chief of section and under the technical supervision of the motor maintenance personnel. When the vehicles are idle, only certain operations need be performed. On the other hand, under extreme operating conditions it might be necessary to perform all the operations every other day to assure proper and uninterrupted vehicle service. Operations to be performed should include the following: The maintenance in conjunction with the inspection after operation as outlined in paragraph 22, the servicing, tightening, and cleaning operations as outlined in paragraphs 40 to 43; the care of tools, equipment, tires, and storage batteries as

outlined in paragraphs 44 to 46; and the report to the motor officer of any defects observed but not corrected.

c. *Lubrication*.—Lubrication operations should be performed by designated personnel in accordance with a lubrication guide furnished with each type of vehicle. This guide represents the minimum requirements and must be increased to meet severe operating conditions. Technical service bulletins are issued from time to time covering changes in lubricants recommended in the manufacturers' guides (sec. V).

d. *Monthly (1,000-mile)*.—This maintenance operation is normally performed by the company, battery, or similar unit mechanics under the supervision of the motor sergeant. A record is made to show the defects that could not be corrected, the time of accomplishment, the mechanic who performed the operation, and the officer who made the maintenance inspection. This record should be retained until the semiannual (6,000-mile) maintenance operations and technical inspection, at which time it may be disposed of as the unit commander sees fit. Pertinent data from the record are entered in the vehicle service record. A guide for this maintenance, which should be modified as necessary for a particular type of vehicle, follows. Tolerances and clearances might well be added. Items marked with an asterisk (\*) may require tools and parts not available or authorized, in which case the defect should be corrected by the next higher echelon:

(1) *Road test.*

- (a) 1. Bring engine to operating temperature and examine for smoke or fumes. Examine condition of oil on measuring stick. Observe any evidences of blow-by or leaks.
2. Test horns, lights, windshield wiper, and other safety devices.

(b) *Drive vehicle.*

1. Test for proper steering.
2. Observe engine for power delivery, acceleration, and unusual noises.
3. Test clutch action. Stop and investigate unusual noises.
4. Test gear sets and final drives for ease of shifting and unusual noises.

5. Test brakes for equalization, stopping distance, pedal travel, and pedal "feel."

6. Observe action of instruments on dash.

7. Observe the final drive and power transmission units while another person drives or while the vehicle is blocked up with the wheels off the floor. Note any overheating of units.

(c) Check lubrication levels after return to motor park.

(2) *Maintenance operations, general.*

(a) Clean and tighten storage battery, terminals, and carrier bolts. Test battery and refill to proper level.

(b) Tighten body bolts, fenders, running boards, splash pan joints, bumpers, brush guards, head lamp brackets, mirrors, tow hooks, pintles, body parts, radiator shell, and hardware.

\* (c) Repair body injuries.

(d) Replace unserviceable instruments or safety devices.

(e) Adjust lights.

(3) *Wheels, brakes, and springs.*

\* (a) Replace worn brake lining.

(b) Correct overlubrication or leakage of lubricant.

(c) Remove looseness or bind from wheel bearings.

(d) Tighten wheel stud nuts.

(e) Correct any leaks in hydraulic or air brake system.

(f) Fill master cylinder to proper level.

(g) Centralize and adjust brakes.

(h) Replace unserviceable shock absorbers and linkage; replenish fluid.

(i) Repair broken or loose spring hold-down bolts, rebound clips, and center bolts. Tighten loose shackle bolts.

(j) Correct any malfunctioning of the brake system.

(4) *Steering mechanism.*

(a) Remove by adjustment or repair any excessive play in:

1. Steering knuckle bearings.

2. Tie rod ends.

\*3. Bushings.

4. King pin wedge bolts.

5. Drag link or connecting link.

6. Pittman arm on sector shaft.

7. Steering gear.

(b) Tighten attachment of steering mechanism to frame, and of steering column to body.

(c) Replace any excessively worn or bent parts.

(d) Tighten, replace, or properly secure all lock washers, cotter keys, nuts, and similar items.

\*(e) Adjust wheel stops when turning radius is incorrect. (Note any wear on drag link.)

(f) Lubricate entire mechanism while front wheels are off the floor. Turn wheels from side to side to insure distribution of lubricant and to ascertain whether or not the entire mechanism works freely.

(5) *Driving axles.*

(a) Tighten loose driving flange nuts and cap screws.

(b) Tighten and properly secure all assembly, pinion carrier, cover plate, spring seat, and other bolts and nuts.

\*(c) Correct any leakage of lubricant.

\*(d) Remove any excessive play or backlash.

(6) *Clutch, transmission, transfer case, propeller shafts, and universal joints.*

(a) Adjust incorrect clutch free travel and floor clearance.

\*(b) Repair defective reverse shifter stop, and malfunctioning shifter mechanisms.

(c) Tighten all loose bolts and nuts, assembly support, carrier, and cover plate.

\*(d) Correct any leakage of lubricant.

(e) Correct misalignment of universal joints.

\*(f) Repair all fractures.

\*(g) Replace excessively worn spline and universal joints.

\*(h) Repair all evidences of slackness, looseness, or leakage.

(i) Open clutch housing drain vent.

(j) Repair or replace muffler or tail pipe.

(7) *Cooling system.*

(a) Tighten radiator supports, braces, and attachment of shell to core.

(b) Adjust fit of hood on shell and fit of hood locks.

(c) Replace unserviceable hose and hose clamps.



- \*(d) Correct all evidences of water leakage.
- (e) Adjust incorrect fan-belt tension; replace unserviceable fan belt.
- (8) *Fuel system.*
  - (a) Clean dirty sediment bowls.
  - \*(b) Correct any leakage in or around the fuel pump.
  - (c) Tighten connections; repair or replace leaking lines.
  - \*(d) Correct any malfunctioning of fuel pump.
- (9) *Engine.*
  - (a) Service all air filters; replace oil filter if required.
  - (b) Tighten engine mountings, flywheel housing, oil pan, flywheel cover, timing-case cover, manifolds, accessory attachments, and other bolts and nuts.
  - \*(c) Correct all breakage, cracks, or leaks.
  - (d) Set manifold heat valve to seasonal adjustment.
  - \*(e) Repair unserviceable breaker points.
  - (f) Replace all damaged wiring.
  - \*(g) Correct malfunctioning generator or starter.
  - \*(h) Correct generator output.
  - (i) Adjust noisy valves.
  - \*(j) If on the road test any missing occurs, the entire ignition system should be carefully checked and spark plugs removed, examined, cleaned, reset, and serviceable ones reinstalled.
  - \*(k) Remove causes of other knocks, noises, and unsatisfactory engine performance. (Vacuum gauge is valuable for diagnosis of troubles).
  - (l) Repair looseness in any controls.
- (10) *Road test.*—Check repairs.
- (11) *Record.*—Prepare a record as follows:
  - (a) *Defects not corrected.*

<i>Unit</i>	<i>Defect</i>

(b) *Mechanic's and motor sergeant's certificate—*

I have performed the maintenance operations as outlined in the guide for monthly (1,000-mile) maintenance operations, and so far as can be determined this vehicle can be expected

to give 30 days, or 1,000 miles, of satisfactory service, except as indicated under defects.

Date \_\_\_\_\_ Signature \_\_\_\_\_ Signature \_\_\_\_\_  
 (Mechanic) (Motor sergeant)

*(c) Maintenance inspection certificate—*

I certify that I have performed the maintenance inspection on this vehicle as required by AR 850-15 and that it can be expected to give 30 days or 1,000 miles of satisfactory service.

Date \_\_\_\_\_ Signature \_\_\_\_\_  
 (Motor officer)

*e. Semiannual (6,000-mile) maintenance operations.—*

These maintenance operations are normally performed by the regimental second echelon of maintenance. Under extremely severe operating conditions certain items may have to be checked every two or three months. An instructional guide similar to that used for the monthly (1,000-mile) maintenance operations should be drawn up. These maintenance operations differ from the monthly operations in that all accessory units and some other parts are disassembled, cleaned, inspected, and lubricated. They are then repaired or exchanged if necessary. Semiannual (6,000-mile) maintenance operations are thus more complete than are those performed monthly or every 1,000 miles, and should assure reasonable vehicle service if the monthly (1,000-mile) maintenance operations are carefully performed. If a shop card is not made out to show the repairs, the mechanic, the items not corrected, and the completion of the inspection, a record similar to that used in conjunction with the monthly (1,000-mile) maintenance operations should be prepared and retained until after the technical inspection. Maintenance operations that should normally be included in the 6-month (6,000-mile) service are—

(1) *Records* to include inspection of vehicle repair and operating records for the past six months (6,000 miles), followed by a road test similar to the monthly (1,000-mile) maintenance.

(2) *Engine tune-up* to include check of oil and air filters, a vacuum and compression test, cleaning of oil pan and interior

of engine, adjustment of valves, adjustment of spark plugs, reconditioning of ignition wiring, generator servicing, starter servicing, ignition servicing, carburetor servicing, and check of tightness and serviceability of all parts and accessories.

(3) *Fuel system* to include examination and servicing of fuel pump, gas lines, carburetor, and tank.

(4) *Cooling system* to include radiator service and check of thermostat, fan belt, and water pump.

(5) *Instruments and electrical systems* to include check, service, or replacement of horn, lights, wiring, windshield wiper, and dash instruments.

(6) *Clutch, transmission, and transfer case* to include clutch travel and floor clearance, reverse shifter stop, transmission and transfer case supports, grease seals, tightness, and lubrication.

(7) *Propeller shafts and universal joints* to include slackness, free movement of spline joints, grease seals, and lubrication.

(8) *Driving axles* to include back lash, inspection, lubrication, and adjustment of wheel bearings, spring clips, spring hold-down bolts, spring shackles, driving flanges, leaks, grease seals, and lubrication.

(9) *Steering mechanism* to include attachment of steering mechanism and column, pitman arm, play in steering mechanism, steering linkage, steering stops, turning angle of front-drive axle, and lubrication.

(10) *Front end* to include spring hold-down bolts, rebound clips, shackles, shock absorbers, lubrication and adjustment of wheel bearings, tie rods, and tires for wear and alignment.

(11) *Wheels and brakes* to include hub bolts, grease seals, brake lining, brake linkage and lines, and brake cylinders.

(12) *General* to include storage battery, body and attachments, curtains, muffler, and tail pipe.

(13) *Engine check* by bringing engine up to operating temperature and checking results of engine tune-up for quietness; idling speed; acceleration; and leaks in carburetor, fuel pump, gas lines, cooling system, oil pressure lines, and oil seals.

(14) *Road test*.

(15) *Record* of operation.

■ 162. **NEW VEHICLES.**—During the break-in period, new vehicles usually require special maintenance operations. War Department instructions, if issued for the particular vehicle, and the manufacturer's recommendations should be followed. Prior to operating the vehicle and again at the end of the break-in-period, a complete mechanical inspection is made. All shortages, defective parts, and malfunctions are entered on the inspection report and action taken to replace or correct them.

■ 163. **COMPANY OR BATTERY AND REGIMENTAL SECOND ECHELON REPAIRS.**—The following examples do not indicate all the operations performed but show some of the common ones. Circular 1-10, OQMG, covers the operations in detail for the entire second echelon.

*a. Company or battery.*—(1) *Adjustments.*—Wheel bearings, pedal clearances, steering gear and linkage, fan belt, water pump, spring shackles, and lights.

(2) *Replacements.*—Carburetor, generator, distributor cap and rotor, fuel pumps, batteries and cables, manifolds, instruments and switches, oil lines and filters, and brake shoes.

*b. Regiment.*—(1) *Adjustments.*—Steering geometry, voltage regulator, carburetors, generators, valve tappets, and timing.

(2) *Replacements.*—Tie rods, distributor points, valve springs, carburetors, thermostats, fuel pump diaphragm, and governors.

#### SECTION IV

#### MARCH MAINTENANCE

■ 164. **GENERAL.**—Maintenance while on a march presents special problems, although, in general, the principles already described apply. The speed maintained, especially on long marches, causes disabled vehicles to become separated from their units by considerable distances in a very short time. This must be considered in making decisions concerning the vehicles and any personnel left with them, especially on sections of road which will soon pass to the control of other units. Personnel and maintenance facilities may become so far separated from their respective units as to en-

danger their return. Because of the unpredictable nature of marches near the enemy, every opportunity for motor maintenance should be used, even if it is impossible to complete the work at one time.

■ 165. MAINTENANCE PERSONNEL.—Where marches of tactical units are involved, each organization will have the maintenance personnel allowed by Tables of Organization, and possibly some attached third echelon personnel. Maintenance personnel of batteries, companies, or similar units normally ride at the tail of their respective units, while the regimental motor maintenance personnel ride at the tail of the regiment.

■ 166. EQUIPMENT, SPARE PARTS, AND SPARE UNITS.—The repair equipment available consists of the tools and equipment allotted by Table of Basic Allowances for each organization. The parts and units carried should be sufficient to cover all malfunctions and failures that experience has shown will probably occur. Where small organizations such as batteries, companies, or similar organizations operate by themselves, sufficient spare units should be furnished from the regimental second echelon or from the third echelon.

■ 167. REPAIR PROCEDURE.—*a.* During marches, roadside repairs to disabled vehicles are frequently temporary in character. The necessity of keeping the vehicles under control often requires hasty repairs sufficient only to complete the trip. Upon reaching its destination, the vehicle should be repaired properly. When a vehicle drops out of its battery, company, or similar unit, the maintenance personnel at the tail of the unit attempt to diagnose the trouble quickly.

*b.* If the diagnosis shows that the vehicle needs a minor repair only, a mechanic with a kit of tools and spare parts is dropped off with the vehicle. In all cases where the vehicle is towing a gun or transporting troops its tactical cargo or tow is removed and loaded or attached to another vehicle. The driver always remains with the vehicle unless ordered by competent authority to abandon it. When a vehicle drops out, it is driven, pushed, or towed off and well to the right of the road, so that other vehicles may pass around without halting. If the vehicle is repaired by the mechanic who was dropped off, it resumes the march at the maximum authorized speed to rejoin the rear of the last unit that has passed.

It does not take its customary place in column but remains at the rear of the first unit ahead until the next halt. If march orders so permit, it then doubles the column and proceeds to its organization. If the mechanic is unable to make the repair, the vehicle is either repaired or towed by the regimental motor-maintenance platoon bringing up the rear of the column.

c. If the mechanical crew of the battery, company, or similar unit decides that immediate repair is not possible, the vehicle may be towed and repairs made later, or it may be abandoned to regimental motor maintenance or to a higher echelon. The decision in all cases is made by the motor officer or, in his absence, by the motor sergeant. This demands considerable practical knowledge and training. Under certain circumstances it is advisable to tow the vehicle until a more suitable place for making repairs can be located. Many considerations, such as type of repair, road, weather, traffic conditions, and distance from bivouac, have a bearing on the motor officer's decision. For example, the regimental motor-maintenance organization should tow a vehicle with a burned-out bearing when only an hour or so from the bivouac. Yet if the same failure should occur shortly after departure from a bivouac, or in the mountains with a heavy load, the repair should be made on the spot if the parts required are available. When repair personnel are working by the side of the road, warning guards, signs, or flags must be put out unless the vehicle is completely off the road. At night, red lanterns should be utilized. Whenever a battery, company, or similar unit maintenance crew stops to diagnose the trouble of a vehicle that has fallen out, care must be exercised that the whole crew does not become separated from its organization. If such were the case, the unit would have no maintenance personnel with it to care for the remaining vehicles of the organization. Maintenance personnel should always be with the organization when it arrives in bivouac, to assist in the inspection, repair, and servicing of the organization vehicles.

■ 168. TOWING DISABLED VEHICLES.—Arrangements in any column for towing disabled vehicles will depend upon the type of vehicle, road conditions, type of march, and other con-

siderations. Certain vehicles may march at the tail of the column for this particular purpose. Some vehicle or vehicles near the rear of each organization should be designated as towing vehicles, if vehicles for that particular purpose are not available, so that when a vehicle falls out a towing vehicle near the rear will halt to tow it if towing is required. Such an arrangement prevents confusion and possible loss of a vehicle for the lack of a towing vehicle. These towing vehicles should be provided with tow bars, tow ropes, or tow chains.

■ 169. ABANDONING VEHICLES.—*a.* When vehicles on the march become disabled and for some reason are not towed or are not capable of being towed with vehicles within the organization, they may be abandoned either temporarily or permanently.

(1) When the abandonment is temporary, the driver and possibly a mechanic are left with the vehicle. In the combat zone consideration must be given to the possibility of not recovering the personnel and facilities thus detached. If a gun prime mover fails, the gun should be coupled to any available vehicle and accompany its organization. Every effort should be made to remove to other vehicles all essential combat equipment prior to abandonment of the vehicle. A driver left with a vehicle awaiting maintenance or salvage personnel should be given explicit orders concerning the removal of the load.

(2) If the abandonment is permanent, the proper steps should be taken to comply with orders covering such action. Vehicles should be tagged to show the reason of their un-serviceability. In time of active operations, supply services will provide measures making it convenient to turn over to them any disabled vehicles. When vehicles are left for the disposition of the supply services, the commander should make arrangements for replacements as soon as possible. When operating units abandon vehicles, the supply service concerned must be furnished accurate reports as soon as practicable of the location and general condition of such vehicles.

*b.* In all cases when a disabled vehicle constitutes a road obstruction it will be removed from the road.

## SECTION V

## LUBRICATION

■ 170. GENERAL.—*a.* Lubrication is one of the most important duties charged to personnel of organizations operating motor vehicles. It is an essential part of preventive maintenance; to a great extent it determines serviceability of parts and assemblies; it materially influences repair and operation costs; and it is one of the most important factors affecting dependable mobility and useful vehicle life. Training, supervision, supplies, and equipment are required for the performance of correct lubrication.

*b.* Correct lubrication provides and maintains under all conditions of operation a suitable oil film between friction surfaces where necessary.

■ 171. METHODS.—*a.* Lubrication operations may be decentralized or centralized. In either case the unit commander assigns definite responsibility for these functions. The motor officer, assisted by the motor sergeant, prepares lubrication schedules, supervises lubrication, and makes frequent inspections to assure himself that all vehicles are properly lubricated. Good teamwork must be developed if the desired results are to be accomplished.

(1) *Decentralized lubrication.*—This method is particularly applicable to field service operations, and will give excellent results when personnel are properly trained and supervised and lubrication schedules are carefully followed. Responsibility is divided as follows:

(a) The driver performs the prescribed driver's lubrication functions (pars. 40 and 41).

(b) The mechanics perform special lubrication to include gear cases, steering gear housing, wheel bearings, universal joints, starting motor, generator, distributor, clutch release bearing, water pump, fan, air cleaner, and changes of crank-case oil.

(c) Chiefs of sections or truck masters are charged with direct supervision of driver lubrication. They should make frequent inspections to insure correct lubrication in accordance with the lubrication schedule.



(2) *Centralized lubrication.*—When this method is employed, all lubricating functions are carried on at a central point and drivers are relieved of all responsibility for lubrication except the replenishment of crankcase oil. When centralized lubrication is applied to a small fleet, responsibility for correct lubrication should be charged to one qualified individual; when the fleet is too large to be lubricated correctly by one individual, assistants should be provided and definite responsibilities should be assigned to each. Vehicles should be sent to the central station when lubrication is required, and should be accompanied by the driver. The driver's services should be utilized to expedite the work. Centralized lubrication is not recommended for field service operations.

b. When motor vehicles are detached from their organizations for such periods of time that they will miss their scheduled lubrication service, provision should be made for the performance of the lubrication functions. This should be accomplished in one of the following ways:

(1) Send qualified personnel and the necessary supplies and equipment with the vehicles.

(2) Arrange for the vehicles to be lubricated by other units.

(3) Provide the necessary supplies and equipment, and direct the driver to perform the lubrication.

■ 172. SCHEDULES.—*a.* Lubrication schedules should be prepared for each make of vehicle assigned to an operating unit. When more than one type vehicle of the same make is assigned, usually one schedule can be devised which, with a few exceptions, will apply to all types of the same make. The schedule or chart furnished by the manufacturer should form the basis for organization lubrication schedules and should be modified to conform to approved recommendations. When the manufacturer's or approved recommendations are not available, schedules should be devised by experienced personnel and steps immediately taken to obtain approved recommendations.

b. Lubrication periods recommended by the manufacturer are generally too infrequent to provide correct lubrication for military motor vehicles and should be modified to meet

operating conditions. In general, the chassis and slow-motion parts should be lubricated after every 7 days or 50 hours of vehicle operation, the crankcase oil should be checked frequently and changed after 500 to 1,000 miles of operation, especially if operated for considerable periods across country or in low gear. The gear lubricants should be checked weekly and changed seasonally, unless operating mileage requires more frequent changes. Severe operating conditions may require immediate attention to lubrication in order to prevent unnecessary wear of parts and assemblies and to assure dependable vehicle performance with reasonable operating and maintenance costs. This is particularly true when vehicles are operated under conditions which permit water to enter bearings and gear cases. Supply of proper lubricants, properly trained personnel, energetic supervision, and strict application of lubrication schedules are necessary to achieve correct lubrication.

■ 173. RECORDS.—A complete record of lubrication should be kept. Responsible personnel should report when lubrication duties have been completed in order that proper entries may be made.

■ 174. LUBRICANTS.—*a. General.*—Lubricants used on military motor vehicles should conform to the recommendations of vehicle manufacturers or of the supply services concerned. When these recommendations are inconsistent, technical service bulletins published by the supply services and local regulations should govern the use of lubricants. When no recommendations are furnished by the manufacturer or the supply service concerned, the selection and use of the proper lubricants should be based on the experience of qualified personnel. During field service it may be impossible to supply a complete assortment of lubricants which meet the above recommendations and it will be necessary to make the best use of those available. The inspection of lubricants is one of the duties of the regimental motor officer.

*b. Types and uses.*—Correct lubrication of motor vehicles requires the use of several types of lubricants and the application of each type in accordance with a lubrication schedule. Types of lubricants and their general uses are as follows:

(1) *Lubricating oils*.—Lubricating oils used on military motor vehicles are exclusively mineral oils obtained by distilling crude petroleum oils. They are characterized by physical properties such as viscosity, viscosity index, flash point, and pour point. They should be used in accordance with the approved recommendations. In general, oils are employed to lubricate engine bearings; starting motors; generators; slow-moving surfaces such as brake pedal pivots and brake linkage, door hinges, and locks; some fan bearings; some water pumps; and some transmissions. Different makes of oils should not be mixed.

(2) *Gear lubricants*.—Gear lubricants are heavy bodied oils, pure mineral oil or pure mineral oil to which materials have been added, used for the lubrication of parts where a strong oil film is required. In general, they are employed for the lubrication of final drives and differentials, transmissions, auxiliary transmissions, transfers, steering gear housings, some wheel bearings, and some universal joints. Approved recommendations should be followed. The following types of gear lubricants are available:

(a) *Fluid gear oils*.—These are pure mineral oils. They are heavier in body than oils used in the engine crankcase, but are usually not so highly refined. These oils are comparable to steam cylinder oil, a dark-colored, heavy-body oil. They are used for the lubrication of gear trains, steering gears, and universal joints where pressures and temperatures are moderate.

(b) *Compound gear lubricants*.—These are blends of mineral oil and soap. The soap, usually a soda type, acts as a filler, but does not increase the lubricating properties of the oil. Normally, compounded gear lubricants are used instead of fluid gear oils when tooth wear has taken place or when the gear housings will not retain a fluid oil.

(c) *Extreme pressure (EP) lubricants and hypoid lubricants*.—These lubricants are mineral oils combined with certain soaps and/or chemicals to increase the oil film strength. They are required for the proper lubrication of final drives where high-unit pressures, combined with severe squeezing action, prevail. A pure mineral oil or a compounded gear lubricant does not provide an oil film strong enough to prevent

metal-to-metal contact under these operating conditions. Hypoid lubricants must be used to lubricate hypoid final drives. Different types of gear lubricants, different makes of EP, or different makes of hypoid lubricants should not be mixed. EP lubricants and hypoid lubricants, being chemically active, are harmful to some metals and are susceptible to chemical changes during use; therefore they should be used in accordance with accepted practice.

(3) *Greases*.—Greases are usually made by compounding mineral oil with a soap. The load-carrying properties of greases, except graphite grease, are determined by the oil used in compounding the grease. Greases are used to lubricate surfaces where pure mineral oil or gear lubricants cannot be retained. The following types of greases are used.

(a) *Chassis lubricant*.—Chassis lubricant or pressure gun grease is usually made by compounding a light oil with a soap. It is available in a variety of consistencies. The consistency may be determined by either the oil or the soap, or both, used in compounding and should not be used as an index to the lubricating and load carrying properties of the grease. Consistency affects ease and manner of application. Chassis lubricants have a natural tendency to spread readily over the bearing surfaces, to cling to them, and to resist the action of water. They are used at practically all points on a motor vehicle that are equipped with pressure grease fittings, with a few exceptions such as water pumps, universal joints, and wheel bearings.

(b) *Cup grease*.—Cup grease has a higher consistency than chassis-lubricant but is not heat resistant. Since the development of special greases there is little or no use for cup grease for the lubrication of motor vehicles.

(c) *Water-pump grease*.—Water-pump grease is usually made by mixing tallow with cup grease. It is not readily soluble in water and has a melting point considerably higher than the boiling point of water. This grease was especially developed for water pumps with gland packings.

(d) *Sodium soap (fiber) greases*.—Mineral oil combined with sodium soap produces greases known as fiber or fibrous greases. These greases are stringy or fibrous in nature, but there is no fibrous material actually present in the grease.

Fiber greases have a high melting point and a very strong tendency to cling to bearing surfaces, making them particularly suitable for the lubrication of parts and assemblies where centrifugal force tends to throw out the lubricant. They are usually soluble in water, thus limiting their use to parts or assemblies that are practically free from the action of water. The general uses of fiber grease are universal joints, wheel bearings, clutch-release bearings, and some drive axle universal joints.

(4) *Miscellaneous lubricants and fluids.*—(a) *Spring lubricant.*—Graphite grease, a mixture of grease and graphite, is generally used for the lubrication of spring leaves. It is not to be used for general lubrication purposes.

(b) *Penetrating oil.*—This oil is used principally to get into places that have become very dry or rusty, such as brake linkage and nuts or bolts that cannot be loosened or tightened with a reasonable amount of force.

(c) *Petrolatum or vaseline.*—Petrolatum or vaseline is used to coat battery terminals and connections to reduce corrosion. It is also used to lubricate the fiber block on the movable breaker point arm in the distributor housing.

(d) *Kerosene.*—Kerosene may be used to thin engine lubricating oil in very cold weather. Approved recommendations should be followed closely when it is necessary to resort to this practice.

(e) *Cleaning solvent.*—Cleaning solvent is a compound fluid used for washing engines, parts, and assemblies. It is not highly inflammable; however, it should be employed with caution when used for cleaning hot engines. When cleaning solvent is not available kerosene may be used.

(f) *Alcohol.*—Hydraulic-brake parts should be cleaned with denatured alcohol. Gasoline, kerosene, cleaning solvents, and oils are harmful to these parts and must not be used for this cleaning.

■ 175. MEANS OF APPLICATION.—Lubricants are applied to the motor vehicle by employing the equipment provided by Tables of Basic Allowances.

a. *Lubricating oils.*—Oil should be placed in the engine crankcase through the crankcase breather or crankcase filler pipe. *Extreme care should be taken to prevent dirt and other*

*foreign materials from entering the crankcase. Oil measures and funnels should be scrupulously clean. Oil is applied to other required surfaces by using an oil or squirt can.*

*b. Gear lubricants.*—Gear lubricants should be introduced into gear cases through their filler pipes. If a gear lubricant bucket with pump is available it should be used to expedite the work. Care should be taken to prevent overfilling, and the level should be checked after the mechanism has been warmed in operation.

*c. Chassis lubricants.*—Chassis lubricants should be applied by using a high-pressure hand gun or a power-operated grease gun. Lubrication fittings should be cleaned before the grease is applied. Grease should be forced through the bearing until clean grease is visible on both ends of the bearing.

*d. Cup grease.*—Cup grease is applied by removing, filling, replacing, and screwing down the grease cups.

*e. Water-pump grease.*—Water-pump grease, when required, should be applied by using a pressure hand gun or by using the grease cup, depending on the lubrication fitting. When the hand gun is used, care must be taken that the pump housing and the gland packings are not damaged.

*f. Fiber greases.*—Fiber greases should be applied to universal joints and clutch release bearings by using a low-pressure hand grease gun or by using the grease cups provided. Care should be taken that grease seals are not damaged. To lubricate wheel bearings, the wheels should be removed, the old grease removed, and the bearings cleaned, dried, and inspected. The bearings should then be dipped or coated with engine lubricating oil (in order to cause the grease to adhere to the balls or rollers) and repacked with the grease. Care should be taken that the correct amount of lubricant is used and that the wheel bearings are properly adjusted. Close adherence to approved recommendations is essential.

*g. Miscellaneous lubricants and fluids.*—(1) *Spring lubricant.*—If the spring is provided with a spring cover, the lubricant should be applied with a grease gun. If no cover is provided, the spring should, when necessary, be removed, disassembled, cleaned, and thoroughly lubricated. Partial

lubrication may be achieved by jacking up the vehicle, separating the spring leaves, and applying lubricant between the leaves with a putty knife.

(2) *Penetrating oil*.—If supplied in small quantities, the penetrating oil will usually be furnished in a can, similar to a squirt can, ready for use. If furnished in quart or larger containers, the oil should be removed from its container, as required, and applied with a squirt can.

(3) *Pétrolatum or vaseline*.—Petrolatum or vaseline should be applied with a brush or by using small quantities applied by hand.

(4) *Cleaning solvent*.—Cleaning solvent should be used with a stiff bristle brush or applied by an air-operated cleaning gun. Metal brushes should never be used when cleaning an engine.

## SECTION VI

### INSPECTIONS.

■ 176. **GENERAL**.—A thorough and comprehensive system of inspections is a primary requisite for the satisfactory operation of motor vehicles. Inspection has as its purpose the detection of deficiencies of mechanical condition, quality of maintenance operation, appearance, servicing, and operation of motor vehicles, and the recommendation of corrective measures to prevent recurrence of such deficiencies. While the appearance of the vehicle as a whole is of some concern, the important inspection is that which covers the normal adjustments and mechanical condition of operating units, and that which investigates the lubrication requirements of a vehicle with a view to maintaining the standards of reliability and performance originally built into the vehicle. Such inspections are classified as command, maintenance, and technical inspections.

■ 177. **COMMAND INSPECTIONS**.—It is the duty of all commanders to make regular and frequent inspections of their motor vehicles and of the operating and maintenance activities of their commands.

■ 178. **MAINTENANCE INSPECTIONS**.—Maintenance inspections are a part of scheduled maintenance operations (par, 161)

and normally should be performed by personnel of the operating organization during and upon completion of these operations.

*a. Daily inspections.*—Daily maintenance inspections normally are made by the chief of section under the supervision of company, battery, or similar unit officers. They consist in checking and supervising the work of the vehicle operator in his performance of daily maintenance operations.

*b. Weekly inspections.*—Weekly maintenance inspections normally are made by the chief of section under supervision of company, battery, or similar unit officers. They consist of checking and supervising the work of the vehicle operator in his performance of weekly maintenance operations. In addition, the chief of section should examine the less accessible places, looking for rust spots, leaks, breaks, and excessive or deficient lubrication. The serviceability and completeness of tools and other equipment should be thoroughly checked. A guide for his weekly inspection should be drawn up and issued to him to fit the particular vehicle or vehicles he is assigned. A suggested guide is as follows:

Accident report.....  
 Appearance.....  
 Battery.....  
 Body bolts and screws.....  
 Bows.....  
 Brakes.....  
 Broken metal.....  
 Bumper and tow hooks.....  
 Canvas.....  
 Chains.....  
 Condition of motor.....  
 Curtain fasteners.....  
 Doors.....  
 Driver's permit.....  
 Extinguisher.....  
 Fender bolts.....  
 Fenders.....  
 Floor boards.....  
 Glass.....



Handle and latches	-----
Hood fasteners	-----
Horn	-----
Insulating material	-----
Keys	-----
Leaks on ground	-----
Lights	-----
Lubrication	-----
Mats	-----
Rear-view mirror	-----
Running boards	-----
Running gear	-----
Seat brackets	-----
Servicing	-----
Special mountings	-----
Springs	-----
Steering	-----
Straps	-----
Tail gate	-----
Tires:	
Cuts	-----
Inflation	-----
Unusual wear	-----
Tool brackets	-----
Tools	-----
Traction devices	-----
Upholstering	-----
Wheel lugs	-----
Windshield wiper	-----
Defects to be corrected:	
	-----
	-----
	-----
	-----
	-----
	-----
	-----
	-----
	-----
	-----

c. *Lubrication inspections.*—All lubrication operations performed by the driver normally are inspected by the chief of section. The motor sergeant inspects all lubrication, includ-

ing that performed by the driver, if any, and that performed by unit maintenance personnel.

*d. Monthly (1,000-mile) inspections.*—The monthly (1,000-mile) maintenance inspection is a check on company, battery, or similar unit maintenance. It normally is made by the motor officer of that unit but may be made by the regimental, battalion, or similar unit motor officer. Before reporting a vehicle to the motor officer for maintenance inspection, the motor sergeant assures himself that the work of his mechanics has been properly performed and that no items have been overlooked. The motor officer spot checks such items as he believes necessary, including those that are inaccessible or frequently neglected. He should make a short road test of the vehicle.

*e. Six-months (6,000-mile) inspections.*—The six-months (6,000-mile) maintenance inspection is a check on the maintenance work performed by the regiment, battallion, or similar unit. It will be made by the unit motor officer, assisted by qualified enlisted personnel, upon completion of the six-months (6,000-mile) maintenance operation in a manner similar to that described for the monthly (1,000-mile) maintenance inspection.

■ 179. TECHNICAL INSPECTIONS.—Technical inspections are made by fully qualified technical personnel of the supply services to determine the vehicle condition. These inspections are covered in AR 850-15 and in Circular 1-10, OQMG. W. D. Q. M. C. Form No. 260 is used.

## SECTION VII

### RECORDS AND REPORTS

■ 180. GENERAL.—In maintaining a fleet of motor vehicles, certain reports and records are indispensable. They must be simple and complete, and must be prepared by qualified personnel. The regimental motor officer should periodically assemble all personnel of the regiment who prepare these records and reports, and explain and demonstrate the proper yet simplest manner of keeping them. Posting of all reports daily or at proper intervals should be enforced by supervisory personnel, and a careful check should be

maintained by the commanding officers of all units operating and maintaining motor transportation. Records often clearly indicate items that require attention. Usually low gasoline or oil mileage might indicate poor motor-vehicle performance or unauthorized disposition of gas or oil by the driver. Excessive repairs might indicate careless driving. The records as a whole keep the organization commander informed of the general condition of the vehicles and assist him in making timely request for overhaul and replacement.

■ 181. REPORTS AND RECORDS REQUIRED BY REGULATIONS.—*a. Driver's Report—Accident, Motor Transportation (Standard Form No. 26).*—This form will be carried on every military motor vehicle. Its use is described in paragraph 48 b.

*b. Investigating Officer's Report—Accident, Motor Transportation (Standard Form No. 27).*—The officer designated to investigate an accident will submit his report on this form (AR 850-15).

*c. U. S. Army Motor Vehicle Operator's Permit (W. D., Q. M. C., Form No. 228).*—This permit must be in the possession of the vehicle operator at all times when he is operating the motor vehicle (pars. 50 and 51).

*d. Motor Vehicle Technical Inspection Report (W. D., Q. M. C., Form No. 260).*—This form will be used in recording the technical inspections required by AR 850-15. (See par. 179.)

*e. Driver's Trip Ticket and Performance Record (W. D., Q. M. C. Form No. 237).*—No vehicle will be dispatched unless a trip ticket accompanies the vehicle. Drivers should be required to complete the form in full detail. These forms provide information required in the vehicle service record books. It is sometimes more convenient to make up a form for local use.

*f. Motor Vehicle Service Record Book (W. D., Q. M. C. Form No. 248).*—This record will be kept for every quartermaster motor vehicle in operation. It constitutes the service record of the vehicle and will be transferred with it. Instructions relative to the posting of this record are contained in the book itself. This is a most important record, and must be accurately and promptly posted.

*g. Ordnance Motor Book (W. D., O. O. Form No. 5956).—*This record will be kept for every ordnance vehicle in operation. It constitutes the service record of the vehicle and will be transferred with it. Instructions relative to the posting of this record are contained in the book itself. This is a most important record, and must be accurately and promptly posted.

*h. Other forms.—*Other prescribed forms are—

(1) Data for U. S. Registration Number (W. D., Q. M. C. Form No. 220).

(2) Motor Vehicle Transfer Form (W. D., Q. M. C. Form No. 221).

(3) Report of Motor Vehicles on Hand (W. D., Q. M. C. Form No. 252).

(4) Report of Changes of Motor Vehicles (W. D., Q. M. C. Form No. 253).

(5) Gasoline and Lubricant Issue Slip (W. D., Q. M. C. Form No. 231).

(6) Motor Vehicle Operation and Maintenance Cost Record (W. D., Q. M. C. Form No. 222).

(7) Dispatching Record (Motor Pools) (W. D., Q. M. C. Form No. 254).

■ 182. SPECIAL FORMS.—Special forms necessary or beneficial in keeping the above records or making the above reports should be obtained from the supply services charged with third and fourth echelon maintenance functions when available. Otherwise such forms or charts must be prepared by the second echelon, normally under the direction of the regimental motor officers. Included are such forms as—

*a. Automotive operations sheet.—*A major part of the data for the motor vehicle record book is abstracted from the driver's trip tickets. Where the entries on this record book are made monthly, a bulky stack of trip tickets accumulates before the entries can be made in the record book. To obviate this condition and to require all operating, inspection, and maintenance data to be consolidated up to date, the operations sheet may be utilized. One of these is required for each vehicle, and is an invaluable aid to the

maintenance personnel. A type operations sheet is shown in appendix II.

*b. Preventive maintenance operations guides.*—These should be similar to the guide shown in paragraph 161.

*c. Lubrication guides.*—A lubrication guide should be prepared for each class and type of vehicle.

*d. Unserviceable vehicle tags.*—This tag, conspicuously attached to a vehicle, indicates a disabled vehicle and provides a ready means of locating the trouble.

## CHAPTER 6

### LOADING FOR MOVEMENT BY RAIL OR WATER

	Paragraphs
SECTION I. Movements by rail.....	183-188
II. Movements by water.....	189-193

#### SECTION I

#### MOVEMENTS BY RAIL

■ 183. REFERENCES.—Information concerning rail movements may be found in the following publications:

AR 30-930.

AR 30-935.

AR 30-940.

AR 30-945.

AR 30-955.

Handbook for Quartermasters.

■ 184. GENERAL PROCEDURE.—*a.* In case of shipment of individual motor vehicles or where the organization does not accompany its transportation, vehicles are turned over to the quartermaster for shipment. In this case the quartermaster is responsible for furnishing the necessary personnel and material for loading and blocking equipment.

*b.* In organized rail movements of troops and their transportation, organizations are grouped and their vehicles are loaded and blocked by their own personnel on suitable railroad cars. Vehicles are usually shipped on flat cars (36 feet to 60 feet in length), gondolas (36 feet to 60 feet in length),

or special box cars (usually 50 feet in length) designed for the handling of motor vehicles. Automobile cars or flat cars with wooden floors are the most desirable types because of the ease of loading and blocking.

c. For tactical organizations being moved by rail, the necessary administrative orders are issued by the commander of the tactical organization through his staff covering details of methods of loading. Normally a quartermaster officer is charged with the responsibility of making the necessary arrangements with the railroad company for the type and number of cars required and point and time of delivery. Sufficient notice should be given this officer to allow him ample time to procure the equipment. If the tactical organization is isolated, the supply officer of the organization is responsible for making the necessary arrangements with the railroad company. The inspection and preparation of railroad equipment before and after loading, such as removing brake handwheels, is accomplished by railroad employees. Whenever it is possible to do so, permanent teams should be used for loading and blocking. Because of their increasing familiarity with their particular jobs, these teams will be more efficient and will accomplish more work than would different teams for each organization. In the long run this procedure will result in a saving of time and labor.

■ 185. PREPARATION OF MOTOR VEHICLES FOR LOADING.—*a.* All preparations not interfering with the operation of the vehicles should be executed prior to the delivery of the vehicles to the loading point.

*b.* If troops are not traveling on the same train with their vehicles, all loose property should be packed and secured in boxes, tool boxes should be locked, and hoods should be sealed down with railroad car seals. If troops do travel on the same train with their vehicles, it is not necessary to secure loose property against theft, but in any case a guard should be provided to watch the vehicles and prevent pilferage.

*c.* When motor vehicles are shipped individually, gasoline is drained from tanks. When vehicles are shipped with troops, in order to expedite unloading, gasoline normally is not drained from vehicles.

*d.* Tires should be inflated to at least 10 pounds above normal pressure in order to avoid sagging or shifting of motor vehicles in blocks.

*e.* Radiators should be drained when there is a possibility of freezing during shipment.

*f.* Batteries should be disconnected.

*g.* Tops, end and side curtains, paulins, and cushions should be secured against wind and weather. Windshields and windows should be closed, doors closed and lashed.

*h.* In order to insure that vehicles have been properly prepared for shipment a systematic inspection should be made with the aid of a check sheet similar to that shown in appendix III.

■ 186. FACILITIES FOR LOADING MOTOR VEHICLES (figs. 26 and 27).—Whenever possible, vehicles are loaded and unloaded by their own power over permanent end ramps or platforms. Movement from one car to another along the length of the train is made possible by cross-over plates or spanning platforms. When no permanent ramps are available, improvised means must be used. Railroad ties are generally available and make excellent building material for this use. Any improvised means of loading must be carefully inspected for safety before it is used. If vehicles must be shipped in gondolas that do not have drop ends, a crane with sling, frequently obtainable from the railroad, is very useful in loading. In the case of shipments in side-door box cars, a dolly-type jack must be used to warp the vehicles into position within the car. In any event, advance loading details should be sent ahead to prepare the loading facilities and have them ready when the vehicles arrive at the entraining point.

■ 187. SECURING MOTOR VEHICLES TO CARS.—*a.* In securing or blocking a vehicle, three motions of the vehicle must be eliminated: lengthwise, sidewise, and bouncing motions.

*b.* Material for this blocking on wooden-floored cars should not be less than 2 by 4 inches. Blocks cut from 6- by 6-inch or 8- by 8-inch material are preferable. Figure 28 illustrates the blocking of a vehicle to prevent sidewise and lengthwise movement and securing of a vehicle to prevent bounce. To further control body bounce resulting from flexing of springs,

straps should be placed over the springs in addition to straps over the axle. Materials best suited for this purpose are strap iron ( $\frac{3}{8}$  inch up to 2 inches), burlap, or rope. When rough timber is used in blocking, canvas, cloth, or burlap should be placed between the tires and the blocks to reduce wear on tires. Blocking should be done snugly to eliminate all play. Frequent inspections should be made to insure that blocking does not come loose. In addition to blocking, brakes should be set and the vehicle placed in low gear.

c. In case the floors of cars are of metal, blocking from side and end walls is required. Material 2 inches by 4 inches is well suited for this purpose.

d. Due to their heavy weight, tanks and combat cars cannot be anchored to the floors of railroad cars as easily as other motor vehicles. When shipped by rail they should be loaded by pairs on a car, facing each other, and then suspended on a triangular ramp built of railroad ties or logs which is anchored to the floor. This can be done by running the vehicles up the opposite sides of the ramp and then coupling the towing clevises together. The transmissions should remain in neutral and the tanks left suspended over the ramp, thus insuring the absorption of sudden jars in train operation by the suspended tanks or combat cars. Side rails should be provided to prevent the loads shifting laterally while in transit.

■ 188. DETRAINING.—Detraining is similar to loading, with obvious modifications. Careful planning will help avoid confusion. It is usually advisable to run vehicles forward to unload, because backing off the ramps may result in accidents. In order to expedite detraining, advance unloading parties should be sent ahead whenever possible to make necessary preparations. After unloading and servicing, a systematic inspection should be made using a check sheet similar to the one used in preparing the vehicle for shipment.



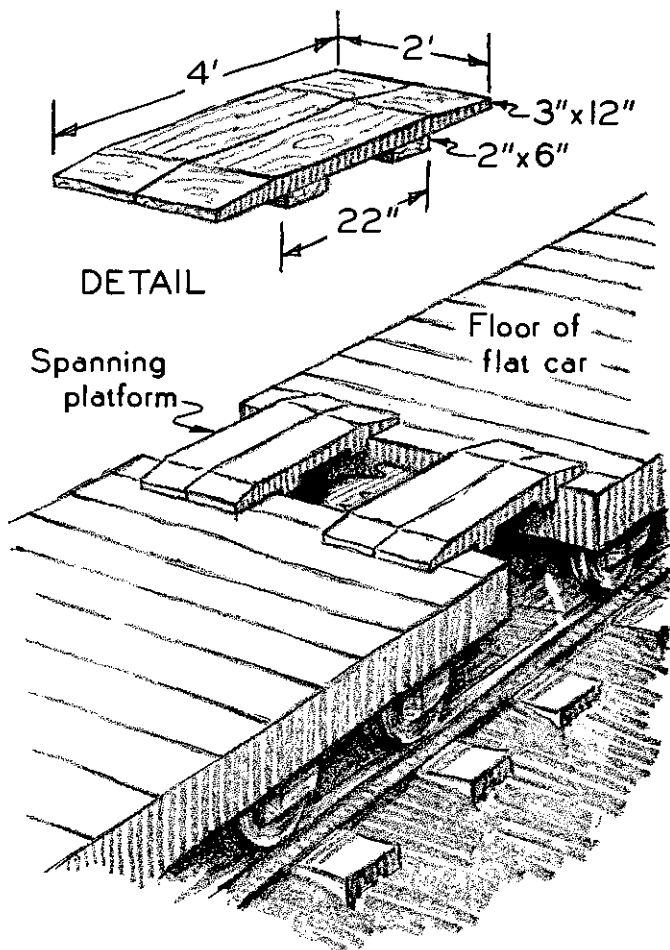

FIGURE 26.—Spanning platform.

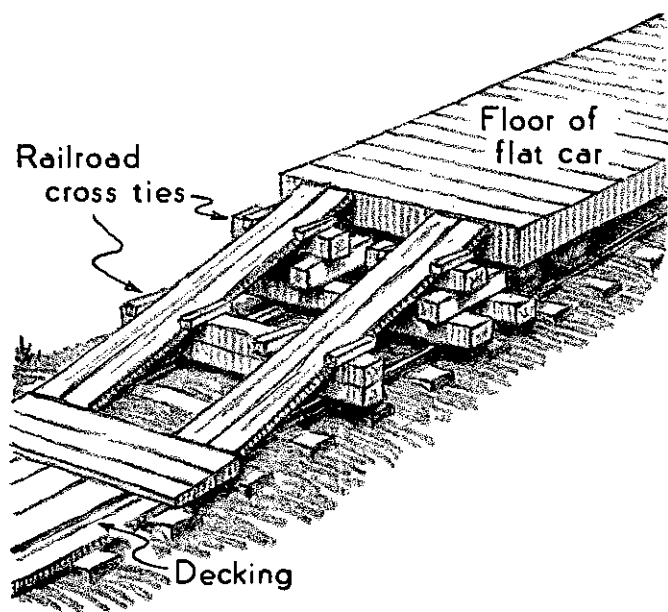

FIGURE 27.—Improvised ramp.

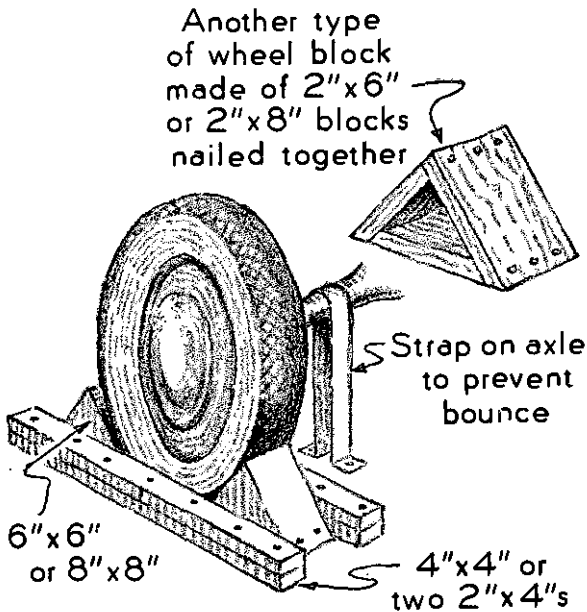

FIGURE 28.—Blocking of vehicles.

## SECTION II

## MOVEMENTS BY WATER.

- 189. GENERAL PROCEDURE.—Preparation of vehicles for water shipment is accomplished by military personnel. Loading and securing of vehicles is accomplished by the ship's personnel under the direction of the transport's officer and with the use of the transport's loading rigging. After loading, movement of vehicles into position on board should be done by the regular military drivers under the vehicles' own power. Because of the dovetailing of the duties of ship's crew and military personnel, close coordination is essential between the ship's officer and the officer in charge of loading.
- 190. PREPARATION FOR SHIPMENT BY TRANSPORT.—Preparation of a vehicle for water shipment is, with obvious modifica-

tions, the same as that laid down for rail shipment. Since the vehicle, after being loaded, is moved into position on board under its own power, gasoline and water are not drained and the battery is not disconnected until the vehicle is in its final position. Preparation of tires, tops, curtains, cushions, and loose property is the same as for rail shipment. Because of a greater tendency for parts to rust during water shipment, special attention must be given to rust prevention. All exposed bright metal parts and exposed working parts should be greased, motors should be turned over by cranking several turns about every 3 days, and under conditions especially likely to cause rust, motors should be slushed with oil inserted through spark-plug openings. As in the case of rail shipments, an inspection with the aid of a check list should be conducted to insure that the vehicle is properly prepared for shipment (appendix III).

■ 191. FACILITIES FOR LOADING.—Loading vehicles on board is accomplished by ship's personnel with the use of the ship's loading rigging. This usually consists of a boom rigged with a block and a winch. Vehicles are raised from the dock and lowered into the hold by means of a sling.

■ 192. SECURING VEHICLES ON BOARD.—Vehicles placed below decks, where there are usually wooden floors, are blocked and secured as described for rail shipping on flat cars. On deck or on other metal floors, vehicles must be lashed in place with stout rope. In either case lengthwise, sidewise, and bouncing motion of the vehicle must be eliminated. Miscellaneous loose equipment should be boxed and secured to avoid shifting which would damage vehicles. After the vehicles are completely secured, the hatches are sealed. Frequent inspections should be conducted, especially during rough weather, to insure that the blocking and lashing is holding and that the vehicles are riding without damage.

■ 193. UNLOADING.—Unloading is conducted by the same personnel and with the same equipment as loading. After the vehicles have been serviced, an inspection with the aid of a check list should be made to insure that the vehicle is properly prepared to resume operation.

## APPENDICES

---

- APPENDIX I. Schedule of instruction—Driver training.  
II. Automotive operations and maintenance sheet.  
III. Inspection report of vehicles shipped by rail or water.
- 

### APPENDIX I

#### SCHEDULE OF INSTRUCTION—DRIVER TRAINING

1. The following schedule of instruction is designed primarily as a guide for the training of drivers who are to operate prime movers with towed loads, but with obvious modifications it will be satisfactory for the training of drivers for any military motor vehicle. The training includes conferences, demonstrations, and practical periods, and is terminated with a qualification examination. The continuity of instruction may be changed to meet local conditions if related conferences and practical periods are coordinated.

1ST PERIOD (2 hours).

*a. Conference.*

- (1) Responsibility of drivers.
- (2) Motor-park organization.
- (3) Personnel and general duties.
  - (a) Unit commander.
  - (b) Motor officer.
  - (c) Motor sergeant.
  - (d) Mechanics.
  - (e) Chiefs of section or truck master.
  - (f) Drivers.
- (4) Fire prevention and fire fighting.
  - (a) Precautions against fire. (AR 850-15 and local orders.)

## MOTOR TRANSPORT

- (b) Proper methods of fighting fires.
  - 1. Gasoline and oil fires—Fire extinguishers, blankets, sand, and chemicals.
  - 2. Other fires.
- (c) Location of fire-fighting equipment.
  - 1. In and around motor park.
  - 2. On the motor vehicle.
- (d) Method of reporting fire—Location of telephones, how and whom to call.

(5) Accident prevention.

- (a) Precautions against accidents.
- (b) Carbon monoxide poisoning.
- (c) Whom to call to get assistance.

(6) The reconnaissance truck or pick-up truck.

- (a) Use.
- (b) General nomenclature.
- (c) Vehicle equipment.
- (d) Characteristics.

b. Questions on material covered during the period.

2D PERIOD (light vehicle, 3 hours).

a. *Conference and demonstration.*

(1) Vehicle controls and their use.

- (a) Steering wheel.
- (b) Foot brake pedal.
- (c) Hand brake lever.
- (d) Spark control.
- (e) Ignition switch.
- (f) Choke.
- (g) Hand throttle.
- (h) Foot accelerator.
- (i) Starter switch.
- (j) Transmission gearshift lever.

(2) Driver position.

b. *Practical.*—Have drivers assume correct position and familiarize themselves with the location and manipulation of controls. (Engine *not* running.)

c. *Conference and demonstration.*

- (1) Inspection prior to starting engine.
- (2) Proper method of starting engine, to include cold-weather starting.

## MOTOR TRANSPORT

- (3) Proper warm-up of engine.
- (4) Inspection after starting engine.
- (5) Driver's arm signals.
- (6) Signals for control of the unit.
- (7) Positions of the gearshift lever.
- (8) Proper use of the clutch, accelerator, gearshift lever, and brakes to start, change gears, and stop the vehicle.

*d. Practical.* (Vehicles to be blocked with all wheels off the ground. A qualified instructor to be assigned to each vehicle.)

- (1) Inspection prior to starting engine, by the numbers.
- (2) Students mount, assume correct position, and familiarize themselves with controls.
- (3) Start and warm up engines.
- (4) Inspection after starting engine, by the numbers.
- (5) Drivers shift transmission into each of the several ratios at will.
- (6) Drivers shift into designated speeds and change direction on signal of instructor. Students give proper arm signals. Repeat until drivers are reasonably proficient.
- (7) Stop engines.

*e. Conference and demonstration.*

- (1) Inspection during operation.
- (2) Inspection at the halt.
- (3) Driver's trip ticket.

*f. Questions on material covered during the period.*

3D PERIOD (light vehicle, 3 hours).

*a. Conference and demonstration.* (Reconnaissance trucks or pick-up trucks to be on a large unobstructed field prior to the conference or to be driven to the field by the assistant instructors.)

- (1) Inspection prior to leaving park.
- (2) Proper procedure to put vehicle in motion.
- (3) Proper method of shifting gears and appropriate gear to use.
- (4) Proper method for stopping vehicle.
- (5) Proper method for backing vehicle.

## MOTOR TRANSPORT

- (6) Duties of assistant driver.
  - (7) Rules of the road.
  - (8) Arm signals for various maneuvers limbered.
    - (a) Explain movements.
    - (b) Distance, interval, guides.
  - (9) Issue trip ticket.
- b. Practical.*
- (1) Inspection prior to starting engine, by the numbers.
  - (2) Inspection after starting engine, by the numbers.
  - (3) Inspection prior to leaving park, by the numbers.
  - (4) Preliminary driving. Students, accompanied by qualified instructors, drive at will to familiarize themselves with the manipulation and performance of their vehicles.
  - (5) Form vehicles in column and maneuver by arm signals.
  - (6) Form line and halt.
  - (7) Inspection at the halt, by the numbers.
- c. Conference.*—How to form park.
- d. Practical.*
- (1) Caretaking.
  - (2) Inspection after caretaking.
  - (3) Completion of trip ticket.
- e. Question drivers.*

NOTE.—In all succeeding periods where operation is involved, include the following, if applicable:

- Issue of trip ticket.
- Inspection prior to starting engine.
- Inspection after starting engine.
- Inspection prior to leaving park.
- Inspection during operation.
- Inspection at halt.
- Forming park.
- Caretaking.
- Inspection after caretaking.
- Completion of trip ticket.



## MOTOR TRANSPORT

### 4TH PERIOD (light vehicle, 3 hours).

#### *a. Conference and demonstration.*

- (1) Nomenclature and functioning of vehicle units and assemblies with particular attention to lubrication.

(To be carried on through the remainder of the course or until drivers are qualified in this subject.)

- (2) Weekly inspection.
- (3) Lubrication.

#### *b. Practical.*

- (1) Inspections.
- (2) Driving.
- (3) Caretaking.

### 5TH PERIOD (cargo trucks, 3 hours).

#### *a. Conference and demonstration.*

- (1) Vehicle characteristics.
- (2) Double clutching.
- (3) Gear range (auxiliary transmission-transfer case).
  - (a) Purpose.
  - (b) Use.
  - (c) Location and operation of shift lever.
- (4) Four-speed transmission—Positions of gear-shift lever.

#### *b. Practical.—Driving.*

### 6TH PERIOD (cargo trucks, 3 hours).

#### *a. Conference and demonstration.*

- (1) Cross-country driving.
- (2) Driving through water.
- (3) Changing tires and repairing tubes.
- (4) Application of traction devices.
- (5) Accident report.

#### *b. Practical.—Cross-country driving, fairly difficult.*

### 7TH PERIOD (prime movers and towed loads, 3 hours).

#### *a. Conference and demonstration.*

- (1) Vehicle characteristics.
- (2) Loads, loading, and lashing.
- (3) Coupling.
- (4) March formations, signals, and distances.
- (5) Rules of the road.

## MOTOR TRANSPORT

*b. Practical.*—Maneuvers, followed by a short road march on good roads.

NOTE.—Drivers' inspections must include towed load.

8TH PERIOD (prime movers and towed loads, 3 hours).

*a. Conference and demonstration.*

(1) Action right, left, front, and rear, with arm signals.

(2) Couple.

*b. Practical.*

(1) Couple and uncouple, at will.

(2) Maneuvers limbered.

(3) Road march.

9TH PERIOD (prime movers and towed loads, 3 hours).

*a. Conference.*

(1) Traffic regulations.

(2) Road marches.

(a) Distances.

(b) Speeds.

(c) Route markers.

(d) March regulations.

(3) Passage through cities and congested areas.

*b. Practical.*—Road march on good roads.

10TH PERIOD (prime movers and towed loads, 3 hours).

*a. Conference and demonstration.*

(1) Difficult draft.

(2) Field expedients.

*b. Practical.*

(1) Cross-country driving, difficult.

(2) Occupation of position.

(3) Disposition of vehicles during firing.

(4) Camouflage.

11TH PERIOD (prime movers and towed loads, 3 hours).

*a. Conference.*

(1) Driving in traffic.

(2) Review rules of the road.

(3) Review traffic regulations.

(4) Map reading.

*b. Practical.*—Road march in traffic.

12TH PERIOD (prime movers and towed loads, 3 hours).

## MOTOR TRANSPORT

a. *Conference*.—Roadside repairs.

(1) Normal.

(2) Emergency.

(3) Action upon return to park.

b. *Practical*.—Road march in traffic.

13TH PERIOD (prime movers and towed loads, 3 hours).

a. *Conference*.—Night marching.

(1) With lights.

(2) Without lights.

b. *Practical*.—Night march, with lights, fairly good roads.

14TH PERIOD (prime movers and towed loads, 3 hours).

*Practical*.—Night march, without lights, same road as 13th period.

15TH PERIOD (prime movers and towed loads, 3 hours).

*Practical*.—Night march, cross-country, with lights.

16TH PERIOD (prime movers and towed loads, 3 hours).

*Practical*.—Night march, cross-country, without lights.

17TH PERIOD (prime movers and towed loads, 8 hours).

*Practical*.—March over varied terrain.

18TH PERIOD (prime movers and towed loads, 6 hours).

*Practical*.

a. Night march over varied terrain.

b. Occupation of position.

c. Disposition of vehicles.

19TH PERIOD (3 hours).

a. *Conference and demonstration*.—Preparation of vehicle for 1,000-mile scheduled maintenance.

b. *Practical*.—Preparation of vehicle for 1,000-mile scheduled maintenance.

20TH PERIOD (4 hours).

*Demonstration and practical*.—1,000-mile scheduled maintenance.

21ST PERIOD (2 hours).

*Demonstration and practical*.—Complete lubrication of vehicle.

22D PERIOD (2 hours).

a. *Conference and demonstration*.—Formal inspection.

b. *Practical*.—Formal inspection.

23D PERIOD (2 hours).

Examination, theoretical, for driver's permit.

## MOTOR TRANSPORT

24TH PERIOD (2 hours).

Examination, practical, for driver's permit.

2. If personnel are selected carefully, the 76 hours of instruction in the training schedule will turn out drivers who are capable of good performance under all reasonable operating conditions. If more or less time is available for instruction, the schedule should be changed generally as follows: With more time available, increase the driving time; with less time available, decrease the conference time.

APPENDIX II

AUTOMOTIVE OPERATIONS AND MAINTENANCE SHEET

Make----- Body----- U. S. A. Reg. No. -----  
 Organization----- Org. No. ----- Speedometer reading 1st of month.-----

Month of.....	1	2	3	4	5	6	7	8	9	10	11	12	13	14	15	16	Fwd
Brt. Fwd.																	
Daily mileage.....																	
Gasoline, gallons.....																	
Engine oil, quarts.....																	
Crankcase drained (mileage).....																	
Tires and tubes, cost.....																	
Units, parts, materials, supplies, and temporary labor charges, cost.....																	
Weekly maintenance operations.....																	
Lubrication operations and inspection.....																	
Monthly (1,000-mile) maintenance operations and inspection.....																	
Six-month (6,000-mile) maintenance operations and inspection.....																	

*Automotive operations and maintenance sheet—Continued*

Month of.....	Br. Fwd.	17	18	19	20	21	22	23	24	25	26	27	28	29	30	31	Total
Daily mileage.....																	
Gasoline, gallons.....																	
Engine oil, quarts.....																	
Crankcase drained (mileage).....																	
Tires and tubes, cost.....																	
Units, parts, materials, supplies, and temporary labor charges, cost.....																	
Weekly maintenance operations.....																	
Lubrication operations and inspection.....																	
Monthly (1,000-mile) maintenance operations and inspection.....																	
Six-month (6,000-mile) maintenance operations and inspection.....																	

### APPENDIX III

## INSPECTION REPORT OF VEHICLES SHIPPED BY RAIL OR WATER

When vehicles are shipped by rail or water an inspection should be made before and after shipment to insure that the vehicle has been properly serviced. The inspection should be systematic and recorded on a check list similar to the following:

*a. Cooling system.*

- (1) Pet cocks on block left open .....
- (2) Pet cocks on radiator left open .....
- (3) Pet cocks cleared (insert wire) .....

*b. Fuel system.*

- (1) Gas tank drained .....
- (2) Engine run until remaining gas is used up .....
- (3) Sediment bowl drained .....
- (4) Fuel pump and carburetor drained (if possible) ...

*c. Storage battery.*

- (1) Positive cable disconnected and taped .....
- (2) Positive cable tied away from battery .....

*d. Tires.*

- (1) Inflated to 10 pounds more than normal .....
- (2) Spare tire locked .....

*e. Miscellaneous.*

- (1) Ignition switch off .....
- (2) Gear shift in low gear .....
- (3) Parking brake set .....
- (4) Hood closed and sealed .....
- (5) Tops, curtains, paulins, and cushions secured .....
- (6) Windshield closed and fastened .....
- (7) Windows closed tight .....
- (8) Doors closed, latched, and lashed .....
- (9) Keys in small cloth bag tied to steering wheel .....
- (10) Tagged for destination .....
- (11) Rust-preventive measures complete .....
- (12) Loose parts boxed and secured .....
- (13) Tool box locked .....
- (14) Parts missing .....
- (15) Damages .....
- (16) Guard posted and familiar with duties .....





## INDEX

	Paragraph	Page
A-frame .....	133	116
Abandoning vehicles.....	169	155
Accident prevention.....	12	5
Accidents to vehicles.....	108	93
Aids to motor vehicle control.....	16	8
Air forces, influence.....	55	35
Aircraft, protection against.....	95	83
Anchored stake.....	135	118
Application of lubricants.....	175	161
Assembly areas.....	112	95
Automotive operations and maintenance sheet.....	App. II	185
Auxiliary transmission, use.....	25	13
Average day's march.....	71	54
Backing vehicles.....	27	15
Bivouac areas.....	112	95
Block and tackle.....	131	116
Boggy ground.....	143	126
Brakes.....	15	7
Use of.....	26	14
Bridges:		
Inspection.....	91	78
To cross.....	150	129
Care of storage battery.....	46	31
Care of tires.....	45	30
Care of tools and equipment.....	44	29
Chains and traction devices.....	32	22
Characteristics of motor movements.....	54	34
Cleaning vehicles.....	43	29
Close column type movement.....	60, 64	40, 43
Clutch.....	15	7
Use.....	24	12
Cold-weather marching.....	99	88
Command inspections.....	177	163
Command of march movements.....	66	47
Composition of orders.....	84	74
Congested areas, passing of columns through.....	92	79
Controls, motor vehicle.....	14	6
Convoys, classification.....	67	48
Curves, to drive on.....	151	130
Deadman installation.....	134	117
Defense against mechanized units.....	96	86
Definitions.....	1, 58, 160	1, 36, 144
Detraining motor vehicles.....	188	172
Detrucking.....	76	68

	Paragraph	Page
Disabled vehicles, to tow.....	168	154
Discipline and training.....	56	35
Ditches, to cross.....	147	128
Double staggered columns.....	74	58
Driver training, schedule of instruction.....	App. I	177
Drivers:		
Reports.....	48	32
Responsibility.....	9	5
Selection.....	8	5
Signals.....	29	17
Training.....	7	4
Driving:		
Difficult.....	33	23
Night.....	34	23
Duties of pioneer parties.....	120	105
Echelons of maintenance.....	156-159	133-143
Elements of motor movements.....	57	35
Emergency roadside repairs.....	49	32
Employment.....	4	2
Engine:		
To start and warm up.....	19	9
To start under unusual conditions.....	28	16
Entrucking.....	76, 100	68, 88
Equipment:		
Care.....	44	29
Pioneer parties.....	119	102
Repair.....	166	153
Examination for operator's permit.....	50	33
Facilities for loading vehicles for shipment—		
By rail.....	186	171
By water.....	191	176
Fire precautions and fire fighting.....	11	5
Flotation, motor vehicles.....	139	120
Fords, inspection.....	90	78
Form and type of orders.....	80	74
Forms, special, for records and reports.....	182	168
Functioning of vehicle.....	37	26
Gear shifting.....	24	12
Graphs, march.....	75	59
Grouser bar.....	125	111
Grouser ropes and chains.....	126	111
Gumbo soil.....	144	126
Halts.....	105	89
Hoist attachment.....	123	109
Ice, to drive over.....	146	127
Importance of orders.....	79	73
Infiltration type movements.....	59, 63	39, 42
Initial points.....	101	89

	Paragraph	Page
Inspection:		
After operation.....	22	12
At the halt.....	21	11
Before operation.....	18	8
Command.....	177	163
During operation.....	20	10
Maintenance.....	178	163
Routine.....	39	27
Technical.....	179	166
Duties during.....	47	31
Inspection report of vehicles shipped, rail or water.....	App.III	187
Instrument-board gages.....	17	8
Load, towed, to turn with.....	152	130
Loading capacities.....	72	57
Loading vehicles for shipment—		
By rail.....	184	169
By water.....	191	178
Loading time.....	73	58
Loads and loading.....	35	24
Logistics.....	69	52
Lubricants.....	174	158
Application.....	175	161
Lubrication.....	37, 41, 170	26, 28, 156
Methods.....	171	156
Records.....	173	158
Schedules for.....	172	157
Lug plates.....	128	111
Maintenance.....	38	26
Basic principles.....	154	132
Duties during scheduled.....	47	31
Echelons.....	155-159	133-144
Inspections.....	178	163
March.....	164	152
Operations.....	161	144
Personnel.....	110, 165	95, 153
Map reading.....	36	25
March:		
Average day's and rates.....	71, 102	54, 89
Graphs and tables.....	75	59
Movements:		
Close column.....	60, 64	40, 43
Infiltration.....	59, 63	39, 42
Open column.....	61, 65	41, 47
Other types.....	62	41
Speeds.....	102	89
Time of starting.....	98	88
Marches, night.....	113	96
Marching.....	31	21
Cold weather.....	99	88
Mechanical expedients.....	137	119
Mechanized forces, influence.....	55	35
Mechanized units, defense against.....	96	86
Messing.....	107	92

	Paragraph	Page
Method of traffic control.....	115	98
Methods of lubrication.....	171	156
Mission of pioneer parties.....	118	101
Momentum of vehicles.....	139	120
Motor movements:		
Characteristics .....	54	34
Elements .....	57	35
Organization .....	68	48
Motor park, organization.....	10	5
Motor vehicles:		
Abandoning .....	169	155
Controls .....	14	6
Disabled, to tow.....	168	154
Inspection report of shipped.....	App. III	187
Maintenance operations.....	161	144
New.....	162	152
To right overturned.....	153	131
Movements by rail:		
Detraining .....	188	172
Loading vehicles.....	186	171
Preparation of vehicles for.....	185	170
Procedure .....	184	169
Securing vehicles to cars.....	187	171
Movements by water:		
Loading vehicles .....	191	176
Preparation of vehicles for.....	190	175
Procedure .....	189	175
Securing vehicles on board.....	192	176
Unloading.....	193	176
Night driving.....	34	23
Night lighting devices.....	136	119
Night marches.....	113	96
Nomenclature of motor vehicle.....	13, 37	6, 26
Open column type movements.....	61, 65	41, 47
Operation, requirements .....	6	2
Operations of maintenance, scheduled.....	161	144
Operator's permit.....	51	33
Examination for.....	50	33
Orders:		
Composition.....	84	74
Form and type.....	80	74
From higher headquarters .....	82	74
Importance of.....	79	73
Staff plans.....	83	74
Warning .....	81	74
Organization of motor movements.....	68	48
Organization of motor park.....	10	5
Overturned vehicles, to right.....	153	131
Parking vehicles.....	27	15
Personnel:		
Maintenance .....	110, 165	95, 153
Traffic control.....	117	100

	Paragraph	Page
Pioneer parties:		
Duties .....	120	105
Equipment .....	119	102
Mission .....	118	101
Pioneer work of reconnaissance officers .....	93	80
Pools .....	5	2
Power of motor vehicles .....	139	120
Preparation of motor vehicles for shipment—		
By rail .....	185	170
By transport .....	190	175
Prolonges .....	130	113
Protection against aircraft .....	95	83
Rates of march .....	71, 102	54, 89
Ravines, to cross .....	147	128
Reconnaissance .....	85	75
Normal procedure .....	89	78
Route .....	86	75
Records:		
Of lubrication .....	173	158
Required by regulations .....	181	167
Special forms .....	182	168
References .....	3, 183	1, 169
Refueling .....	106	91
Repairs:		
Echelon .....	163	152
Emergency roadside .....	49	32
Procedure .....	167	153
Reports:		
Drivers .....	48	32
Required by regulations .....	181	167
Special forms .....	182	168
Requirements for operation .....	6	2
Responsibility of drivers .....	9	5
Reversing direction .....	109	94
Road capacities .....	74	58
Road rules .....	30	20
Road space for halted vehicles .....	70	52
Roads, muddy .....	142	123
Route marking .....	94	80
Sand, to pass through .....	145	126
Schedule of instruction, drivers .....	App. I	177
Schedules of lubrication .....	172	157
Scope of manual .....	2, 52	1, 34
Securing motor vehicles for shipments—		
By rail .....	187	171
By water .....	192	176
Selection of drivers .....	8	5
Servicing vehicles .....	40	27
Shuttling .....	77	72
Signals, drivers' .....	29	17
Soils, gumbo and sticky .....	144	126
Snow, to drive on .....	146	127
Spare parts and units .....	166	153
Speeds of march .....	102	89

	Paragraph	Page
Spreader bars .....	129	112
Staff plans .....	83	74
Starting engine .....	19, 28	9, 16
Steep slopes:		
To ascend .....	140	121
To descend .....	141	122
Storage battery, care .....	46	31
Streams:		
To cross .....	149	129
To ford .....	148	128
Supplies, operating .....	78	72
Swampy ground .....	143	126
Tables, march .....	75	59
Technical inspections .....	179	166
Duties during .....	47	31
Tightening operation .....	42	28
Time length for column of vehicles .....	70	52
Time of starting march .....	98	88
Tires, care .....	45	30
Tools, care .....	44	29
Tow chains and cables .....	128	112
Towing bars .....	132	116
Traction, motor vehicles .....	139	120
Traction devices .....	32, 121	22, 106
Tractors, track-laying .....	124	111
Traffic control:		
Method .....	115	98
Personnel .....	117	100
Traffic regulations .....	30	20
Traffic restriction .....	116	100
Training of drivers .....	7	4
Transmission .....	15	7
Use .....	25	13
Trouble truck .....	122	108
Turning vehicle .....	27	15
Turns, to negotiate with towed load .....	152	130
Unloading vehicles shipped by water .....	193	173
Warning orders .....	81	74
Wheel mats .....	127	112
Wrecking crane .....	123	109
Wrecks .....	111	95