

MHI
Copy 3

Army Military History Institute
Fort Mifflin Barracks, Pa. 17018
FM 25-10

WAR DEPARTMENT

BASIC FIELD MANUAL

MOTOR TRANSPORT

March 12, 1942

MHRC
COPY

FM 25-10

BASIC FIELD MANUAL



MOTOR TRANSPORT



**UNITED STATES
GOVERNMENT PRINTING OFFICE
WASHINGTON : 1942**

WAR DEPARTMENT,
WASHINGTON, March 12, 1942.

FM 25-10, Basic Field Manual, Motor Transport, is published for the information and guidance of all concerned.

[A. G. 062.11 (5-15-41).]

BY ORDER OF THE SECRETARY OF WAR:

G. C. MARSHALL,
Chief of Staff.

OFFICIAL:

J. A. ULIO,
Major General,
The Adjutant General.

DISTRIBUTION:

B and H 1, 2, 6, 7 (5); R (10); Bn (5); C 5, 11, 17 (10);
IC 2, 4, 6-10 (10).

(For explanation of symbols see FM 21-6.)

TABLE OF CONTENTS

	Paragraphs	Page
CHAPTER 1. General -----	1-6	1
CHAPTER 2. Driver.		
Section I. General-----	7-8	5
II. Preliminary instruction-----	9-19	6
III. Maintenance by driver-----	20-34	14
IV. Driving instruction-----	35-47	23
V. Examination and operator's permit-----	48-49	34
CHAPTER 3. Motor march.		
Section I. General-----	50-54	35
II. Types of march-----	55-59	41
III. March technique-----	60-71	53
IV. Orders-----	72-75	71
CHAPTER 4. Traffic management.		
Section I. General-----	76-82	75
II. Elements of traffic management-----	83-85	77
III. Reconnaissance-----	86-96	78
IV. The traffic plan-----	97-104	85
V. Execution of traffic plan-----	105-113	89
VI. Traffic aids-----	114-117	95
VII. Logistical data-----	118-134	103
CHAPTER 5. Protective measures.		
Section I. General-----	135-143	125
II. Antiaircraft defense-----	144-148	128
III. Antimechanized defense-----	149-153	132
IV. Protection against chemical agents-----	154-158	138
V. Handling of explosives and inflammable liquids-----	159-163	142
VI. Security detachments-----	164-171	144
CHAPTER 6. Pioneer work, field expedients, and difficult operations.		
Section I. Pioneer parties-----	172-174	150
II. Field expedients-----	175-186	157
III. Difficult operations-----	187-203	166
CHAPTER 7. Military automotive maintenance.		
Section I. General-----	204	179
II. Organization for maintenance-----	205-209	180
III. Echelons of maintenance-----	210-215	193
IV. March maintenance-----	216-221	207
V. Lubrication-----	222-227	210
VI. Inspections-----	228	216
VII. Records and reports-----	229-230	219
CHAPTER 8. Loading for movement by rail or water.		
Section I. Movements by rail-----	231-232	223
II. Movements by water-----	233-237	224
APPENDIX I. List of references -----		226
II. Schedule of instruction—Driver training-----		227
III. Road test procedure (short form)-----		235
IV. Written examination for driver-----		240

TABLE OF CONTENTS

Appendix	Page
V. Regulations concerning shipment of explosives and gasoline by truck-----	242
VI. Inspection report of vehicles shipped by rail or water-----	245
VII. Daily report—Status of motor vehicles (9:00 AM) -----	247
VIII. Automotive operations and maintenance sheet -----	248
IX. Standard form—Driver's aptitude test-----	249
INDEX-----	255

BASIC FIELD MANUAL

MOTOR TRANSPORT

(This manual supersedes FM 25-10, September 18, 1939, including section II, Training Circular No. 66, War Department, 1941.)

CHAPTER 1

GENERAL

■ 1. DEFINITION.—The term “motor transport” as used in this manual applies to motor vehicles used for transporting military personnel, weapons, equipment, and supplies, excluding essentially combat vehicles such as tanks, scout cars, and armored cars.

■ 2. SCOPE.—The general fundamentals set forth in this manual apply primarily to the operation, inspection, maintenance, and management of motor transport and to the training and duties of the operating, maintenance, and traffic personnel.

■ 3. REFERENCES.—The references listed in appendix I should be consulted in conjunction with the study of this manual.

■ 4. EMPLOYMENT.—*a. Uses.*—Military motor transport is used for the movement of troops, matériel, and supplies in all kinds of operations. All types of movements are included, from those of small units by organic transport to those of large forces by the army motor pool.

b. Supplementary transportation.—When commercial motor vehicles are used for emergency troop movements, special consideration must be given to their nonuniformity in performance, carrying capacity, and maintenance requirements.

■ 5. MOTOR TRANSPORT POOLS.—In general, it will be found that a pooling of effort in the use of motor transport will give the most efficient and economical results (AR 850-15).

a. Administrative pool.—In this type of pool, the vehicles and personnel remain with the organizations to which they are assigned and operate from the organization motor parks.

b. Physical pool.—In some cases, the actual grouping of vehicles and personnel from various organizations is advisable. This is normally confined to motor transport units and on rare occasions to tactical vehicles.

■ **6. REQUIREMENTS FOR EFFICIENT OPERATION.**—*a. Assignment of drivers.*—A driver and an assistant driver should be assigned to each motor vehicle. Except for instruction, inspection, or like purposes, the vehicle should not be operated by other drivers if it can be avoided.

b. Prevention of vehicle abuse.—Vehicle abuse is the chief cause of mechanical failures, excessive operating and maintenance costs, and general unsatisfactory performance of the motor vehicle and its component parts. The following forms of vehicle abuse should be prohibited:

(1) Improper use of controls, particularly gear shift, clutch, brakes, and choke.

(2) Racing engine, especially when cold.

(3) Overspeeding, particularly over rough roads and across country.

(4) Improper lubrication.

(5) Deferred maintenance, including lack of proper servicing and adjustments.

(6) Lack of systematic maintenance inspection and follow-up.

(7) Overloading and improper loading.

c. Speed limits.—(1) The caution plate mounted on a motor vehicle indicates the maximum safe speed for which the vehicle is designed.

(2) The table which follows indicates normal speed limits for individual vehicles under favorable conditions. For march rates see chapter 4.

Vehicle	In towns	Open high-way
		<i>mph</i>
Trucks	Conform to local speed limits	35
Command trucks (½-ton).....do.....	45
Light passenger vehicles.....do.....	50
Motoreycles.....do.....	50

(3) Fast driving over rough, slippery, or congested roads will not be permitted.

(4) Applicable speed limits set by State or local regulations will not be exceeded. Should emergency conditions require otherwise, appropriate arrangements will be made with local traffic authorities.

(5) Regulated governors, when installed, will be set and sealed at the maximum speed considered safe and not exceeding that indicated on the caution plate.

(6) Vehicle equipped with a tachometer will be driven habitually in an appropriate gear and not to exceed its prescribed speed in engine revolutions per minute.

(7) In the conduct of marches, the pace will be set by a leading vehicle at such a rate that the slowest vehicle in the column can keep up without exceeding safe and economical speeds.

(8) When passing through towns and villages, a proper reduction in speed will be directed by the column commander, who should control the march in such manner as to insure the safety of spectators and civilian traffic and to prevent prolonged operation at low speeds in a high gear. All such movements necessarily require coordination with local traffic authorities so as to permit the passage of entire serials through "stop" streets or intersections controlled by signal lights without the necessity of a stop by each individual vehicle.

d. Factors affecting operation.—(1) Proper selection, training, and discipline of operating and maintenance personnel.

(2) Strict supervision and control of operations by commissioned and noncommissioned personnel.

(3) Organized maintenance with adequate repair facilities and the performance of routine maintenance and inspection functions.

(4) Serviceable mechanical condition of vehicles, including safety devices.

(5) Recognition of the capabilities and limitations of all types of vehicles in operation.

(6) Careful reconnaissance of routes to be traveled.

(7) Recognition of the capabilities and limitations of the drivers.

(8) Training and experience of the commissioned and non-commissioned personnel.

(9) Recognition of the capabilities and limitations of the road net.

(10) Limitations imposed by the tactical plan and enemy activity.

CHAPTER 2

DRIVER

	Paragraphs
SECTION I. General	7-8
II. Preliminary instruction.....	9-19
III. Maintenance by driver.....	20-34
IV. Driving instruction.....	35-47
V. Examination and operator's permit.....	48-49

SECTION I

GENERAL

■ 7. TRAINING (see TF 11-228).—*a.* The proper training of drivers is the responsibility of all unit commanders. To train drivers who are competent to operate the vehicles of their organizations either alone or in column, a systematic and progressive course of instruction must be given. Training schedules should include a maximum of practical instruction and a minimum of classroom work.

b. (1) Methods of instruction should follow those prescribed in FM 21-5, which include the following steps or phases:

- (*a.*) Preparation on the part of the instructor.
- (*b.*) Explanation.
- (*c.*) Demonstration or illustration.
- (*d.*) Application or practice to acquire skill in execution.
- (*e.*) Examination or test, to determine progress or proficiency.
- (*f.*) Discussion, to point out correct or incorrect methods of execution.

(2) To attain the maximum progress, it is best to provide an instructor for each three students, all to function under a senior instructor. The students alternate in driving; those not driving observe the instruction of, or the execution by, the student who is driving. (See app. II.)

■ 8. SELECTION OF DRIVERS.—*a.* The individuals selected for drivers should be of average size or larger, be moderate in habits, alert, dependable, intelligent, and have good judgment. In addition, they should possess the following qualifications:

(1) An accident-free driving record in case of previous experience.

(2) Normal vision without glasses (visual acuity correctable with glasses to not less than 20/30 acceptable).

(3) Average depth perception.

(4) Normal vision at night.

(5) Normal hearing.

(6) Normal reaction time.

(7) Ability to differentiate between red, green, and amber lights.

b. Through observation and test, the unit commander should determine the aptitude of prospective drivers before any instruction is given, eliminating at the start, most of the men who are inherently unsuitable. (See app. IX for examples of aptitude tests.) In doubtful cases, information obtained through observation and test should be supplemented by that obtained from station surgeon, former employers, or traffic officials. (See TM 31-300.)

SECTION II

PRELIMINARY INSTRUCTION

■ 9. RESPONSIBILITY.—The instructor should explain the object of the training to be given and the responsibility of the driver in making his organization an efficient one. This responsibility includes—

a. Operation and maintenance of motor vehicles in accordance with instructions.

b. Care, condition, and use of vehicle tools and equipment.

c. Loads and loading.

d. Reports and trip tickets.

■ 10. ORGANIZATION OF MOTOR PARK.—The driver should be acquainted with the organization of the motor park and with his duties in connection therewith.

■ 11. FIRE PRECAUTIONS AND FIRE FIGHTING.—Motor vehicles, shops, and parks are constantly exposed to fires. Drivers must, therefore, be instructed in the use of fire-fighting equipment and required to comply with pertinent fire-prevention regulations. (See app. V.)

■ 12. ACCIDENT PREVENTION.—The formulation and observance of definite rules will eliminate the majority of accidents incident to the operation and maintenance of motor vehicles. These rules should include the following:

a. Place the transmission gear shift and power take-off levers in neutral, and set the hand brake before hand cranking an engine or starting it with the starting motor.

b. Make sure the way is clear and no personnel is endangered before a vehicle is moved. If the driver cannot see the road, he should be directed by a dismounted individual, who should precede the vehicle at a safe distance. This is particularly important when a vehicle is backed or is moved through bivouac areas and across country at night without lights.

c. If it is necessary for a mechanic to work under the vehicle while the engine is running, make sure that the vehicle cannot move accidentally, and that there is no loose clothing that can catch on moving parts.

d. Block up a vehicle safely before the wheels are removed.

e. In order to prevent accidental shorts, remove or disconnect the battery when the engine is being cleaned.

f. To avoid carbon monoxide poisoning, provide ample ventilation for garages, shops, vehicle cabs, and vehicles carrying personnel.

g. Do not operate motor vehicle engines in a garage or shop longer than necessary to move the vehicle in or out, unless the vehicle is standing near wide open doors or the exhaust gases are removed through a safe outlet pipe.

h. In using trouble lights near engine or under hood, be sure wire guard is not bent, and that light cannot fall and be broken.

i. The driver will not smoke while vehicle is in motion.

■ 13. NOMENCLATURE AND GENERAL PURPOSE OF MAJOR UNITS OF MOTOR VEHICLE.—Preliminary instruction should cover the nomenclature and purpose of major assemblies only, in order that the driver may become familiar with his vehicle without being confused by detail.

■ 14. SIGNALS (see TF 11-262).—a. Before a driver changes the direction or slows the speed of his vehicle, he should give the appropriate arm signal to warn other drivers of the con-

templated change. Arm signals should be clearly made and should be given in time to afford ample warning.

b. The following arm signals are prescribed for military use:

(1) *Turn right.*—Extend the left arm outward at an angle of 45° above the horizontal.

(2) *Turn left.*—Extend the left arm outward horizontally.

(3) *Slow or stop.*—Extend the left arm outward to an angle of 45° below the horizontal.

(4) *Start engine.*—Simulate cranking.

(5) *Report when ready to move* (given by unit commander).—Extend the arm vertically, fingers extended and joined.

(6) *Ready to start.*—Senior in truck stands on running board, faces leader, and extends the arm toward him, fingers extended and joined, palm toward the leader.

(7) *Stop engines.*—Cross arms in front of body at the waist and then move them sharply to the side. Repeat several times.

(8) *Increase speed.*—Carry closed fist to the shoulder and rapidly thrust it vertically upward several times to the full extent of the arm.

(9) *Decrease speed.*—Extend arm horizontally from the shoulder on to front and move arm up and down vertically about 24 inches; continue motion as long as a decrease in speed is desired.

(10) *Prepare to mount.*—Extend the arm horizontally to the side, palm up, and wave the arm upward several times. *Mount*—same signal with both arms.

(11) *Prepare to dismount.*—Extend the arm diagonally upward to the side, palm down, and wave the arm downward several times. *Dismount*—same signal with both arms.

(12) *Close up.*—Extend the arm horizontally to the side, palm to the front, then describe a 2-foot vertical circle. Each driver repeats.

(13) *Open up.*—Extend the arm horizontally to the side, palm to the front, then move the arm down to a vertical position and up to the horizontal, describing a 90° arc. Each driver repeats.

(14) *Pass and keep going.*—Extend the left arm horizontally and describe small circles toward the front with the hand.

(15) *Immediate danger*.—Use three long blasts of whistle, vehicular horn, siren or klaxon repeated several times, or three equally spaced shots with rifle or pistol. The person giving the signal points in the direction of impending danger. This signal is reserved for warning of air or mechanized attack, or other immediate and grave danger. At night the alarm signal will be supplemented by voice warning to indicate direction of danger.

(16) *Drivers to turn around simultaneously*.—Extend the arm downward, palm to the front. Then move the arm in a continuous motion sideward and upward, and sideward and downward, describing a 180° arc. Each driver repeats.

c. Special signals for ceremonies and drills may be found in the manuals for the arms and services.

d. In addition to the prescribed arm signals, electrical and mechanical signals should be used when vehicles are so equipped.

■ 15. ROAD RULES AND TRAFFIC REGULATIONS FOR DRIVERS (see TF 11-262).—Observance of prescribed road rules and traffic regulations permits the movement of traffic with a maximum of safety and a minimum of confusion and traffic direction. The following general rules will be observed by all drivers:

a. Keep to the right of the road.

b. Give the appropriate warning signal before changing direction, slowing down, or stopping.

c. Keep on the alert for road signs, column signals, traffic directions, bad spots in road, and side roads.

d. Give the right-of-way promptly to faster moving vehicles.

e. Reduce speed on dry, dusty roads.

f. If driving at night with lights, dim your lights when meeting another vehicle.

g. Use horn only when necessary.

h. If your vehicle is disabled, pull to the right of the road and signal the succeeding vehicles to pass.

i. At intersection of roads of parallel importance, give the vehicle on the right the right-of-way.

j. In absence of traffic policeman, signs, or traffic lights, vehicles on a primary road have right-of-way over those on a secondary road.

k. Do not pass another vehicle in your column unless that vehicle is disabled or you are ordered or signaled to do so.

l. Do not pass traffic moving in the same direction as your own—

(1) When going around a corner or blind curve.

(2) When ascending or descending hills unless you can see safe passage is assured.

(3) At street intersections or crossroads.

(4) When the road is not wide enough to allow at least 2 feet between vehicles.

m. When meeting and passing an oncoming vehicle you will—

(1) Pass on the right giving at least half the road.

(2) Slow down if operating conditions are hazardous.

(3) Permit the vehicle having a clear road ahead to have the right-of-way.

n. Halt at railroad crossings not guarded by military personnel or civilian watchmen, and proceed in low gear when safe.

o. Slow down to a safe stopping speed at all road intersections not covered by traffic control personnel or traffic control devices. Drivers will determine by actual test with maximum load the speed at which a right turn can be made without crossing center of road and without "screeching of tires," and will always conform to this speed when approaching an intersection.

p. Do not coast down hills with the clutch disengaged or the transmission in neutral.

q. Clear the roadway before halting.

r. Do not halt on bridges, in defiles, at points where the vision of other drivers is restricted, or in such manner as to block cross traffic or entering side traffic.

s. During the halt—

(1) Stop your engine if the vehicle is to stand longer than a few minutes.

(2) When dismounted keep to the right of the vehicles, and off the traveled part of the road.

(3) Perform the prescribed inspection and maintenance functions (par. 33).

t. Obey the State and local traffic regulations unless otherwise ordered.

u. Under blackout conditions, conform strictly to all restrictions on the use of lights.

■ 16. CHAINS AND TRACTION DEVICES.—Chains and traction devices should always accompany the vehicle to which they pertain. They should be kept in serviceable condition and in proper adjustment to permit installation with a minimum of delay. Chains and traction devices should be removed when the necessity for their use no longer exists, in order to prevent unnecessary damage to roads and wear on tires, chains, and traction devices.

a. Chains.—Chains are generally necessary in mud, sand, snow, or slush-ice. Chains should not be used on ice-covered roads when they cannot bite into the ice. The following general rules apply to the application and use of chains:

(1) Chains are applied before the vehicle becomes mired.

(2) Chains are so applied that rotation of the wheel tends to close the chain fastenings. If improperly installed, rotation of the wheel opens the fastening and the chain will be lost.

(3) Fairly loose adjustment gives better traction and less tire wear than tight adjustment.

(4) On all-wheel-drive vehicles without center differential or other compensating torque device, chains must be installed on all wheels to prevent unnecessary strain.

(5) When only single chains are provided for dual-tired wheels, they should be installed on the outside tires.

b. Traction devices.—(1) Traction devices temporarily convert a truck into a vehicle having many of the cross-country capabilities of a tractor. Training with them should be conducted frequently under conditions favorable to their use, such as in sand or mud.

(2) If traction devices which are applied to individual wheels cannot be tightened sufficiently to prevent slippage of the wheel inside the device, they should be chained to the wheel.

(3) When traction devices are applied on a 6-wheel, 6-wheel-drive (6 x 6) truck, it is preferable, under most conditions, to use an oval-band coupling around the middle and rear wheels rather than individual devices on each of these wheels. The truck then becomes a half-track vehicle with exceptionally low ground pressure.

■ 17. USE OF WINCH.—The operation, use, and care of the winch are discussed in Motor Transport Technical Service Bulletin No. Z-10, Quartermaster Corps. These subjects, and also the use of the block and tackle with the winch, should be covered during drivers' instruction. In addition, practice in the use of the winch should be worked in during the periods devoted to cross-country driving.

■ 18. LOADS AND LOADING.—In order that vehicle capacity and cargo space may be efficiently used, it is necessary that drivers have a knowledge of loads and loading. The driver ordinarily should not be required to handle cargo during the loading and unloading operations, but he should be directly charged with the following responsibilities:

a. Maximum authorized load not exceeded unless ordered by proper authority.—The maximum pay load, road and cross country, and the maximum tow load are shown on the vehicle name and caution plate. These loads should not be exceeded except in case of emergency, and then only when specially authorized. Lack of knowledge of cargo weight is not an acceptable excuse for overloading. In order to prevent overloading when cargo weight is unknown and scales are not available, the driver must determine in advance the level of the rear spring ends under maximum authorized load. Any load that depresses the springs below that level is an overload.

b. Proper location and reasonable distribution within body (see fig. 1).—Efficient loading insures maximum use of cargo-carrying capacity and safety in transit. One loose piece of cargo may release an entire load; and, if the load is unbalanced, the vehicle is in danger of overturning, is difficult to handle, and is a menace to traffic. The following principles should be observed for correct loading:

(1) Heavy supplies should be placed at the bottom of the load and properly distributed.

(2) In building up the load, place cargo carefully to avoid shifting, and distribute the weight equally on both sides of the body.

(3) Loads should not be built up too high. High loads cause swaying and danger of overturning and make the vehicle hard to handle.

(1) Headed barrels - pyramid loading; tail gate lowered and tarpaulin partially cut to reveal manner of loading.

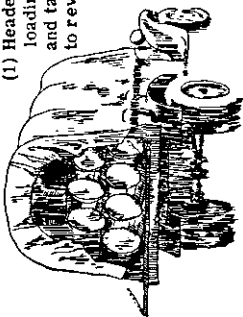

(2) Bags and bundles - pyramid loading; tail gate lowered and tarpaulin partially cut to reveal manner of loading.

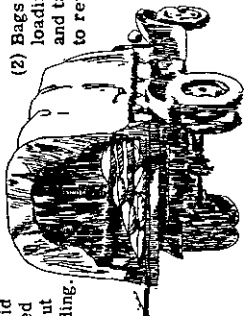

(3) Improper loading - load not balanced; tail gate not shown to reveal details of loading.

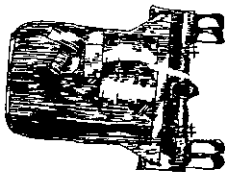

(4) Keeping weight or cargo off tail gate and preventing shifting of load; cutaway view showing load support inside vehicle.

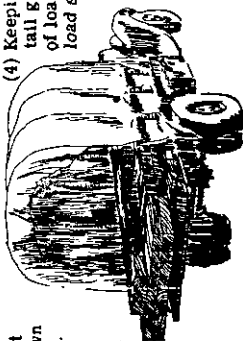

FIGURE 1.—Loading of vehicles.

(4) If the truck is not a covered vehicle, a tarpaulin should be placed over the cargo as a protection against sun, dust, or rain.

c. Proper securing of load to body.—(1) The safety of loads on cargo vehicles is dependent upon proper distribution within the body and the protection offered by the tarpaulin in combination with its rear and front curtains. Cargo lashing is only required in connection with loads of great length or height.

(2) Towed loads are attached to their prime movers or towing vehicles by means of the lunette on the towed load placed in a pintle on the towing vehicle. The pintle latch must be closed and secured before the load is moved. Safety chains, when available, should be used. Care should be taken in regard to hooking up the electrical connections for lights and brakes on trailers.

d. Safety of load in transit.—After the load has been placed in or attached to his vehicle, the driver is responsible for its safety until the destination is reached.

e. Projecting loads.—The rearmost extension of a load that extends beyond the tail gate must be marked with a red flag.

f. Explosives and inflammable liquids.—The driver is responsible for proper handling and transport of explosives and inflammable liquids. (See app. V.)

■ 19. MAP READING.—Military motor vehicle drivers should receive sufficient instruction and training in map reading to enable them to follow routes on marked maps, to choose routes, and to recognize terrain features represented on topographic maps. Training should include the use of commercial highway maps, military topographic maps, military road maps, airplane photographs, and mosaics.

SECTION III

MAINTENANCE BY DRIVER

■ 20. GENERAL.—*a.* Proper maintenance is essential to economical operation of motor vehicles. This entails the coordination of maintenance functions. Those charged to the operating organizations embrace preventive maintenance, minor repairs, and unit replacement possible within the lim-

its of the time available, utilizing hand tools and light portable equipment provided in Tables of Basic Allowances.

b. In the organization maintenance set-up, the driver and assistant driver are responsible for preventive-maintenance functions within the limits of their ability and the equipment available for their use. Driver preventive-maintenance functions include servicing, lubrication, tightening, cleaning and washing, care of tools and equipment, care of tires, care of storage battery, and above all *correct driving*. In this connection the technical manual issued with each truck will be studied carefully.

c. Efficient enforcement of preventive maintenance is the responsibility of commanding officers of all units operating motor vehicles. In carrying out this function, definite maintenance duties will be assigned the motor vehicle operator and he will be prohibited, except in an emergency, from performing any maintenance function not specifically assigned. (See AR 850-15.)

d. When operating conditions are particularly arduous, better results may occasionally be obtained by relieving drivers and assistant drivers of all inspection and care-taking functions normally performed after operation and requiring the maintenance section or other designated personnel to perform the duties. This practice should be resorted to only when absolutely necessary.

■ 21. SERVICING.—a. Servicing is defined as the check and necessary replenishment of gasoline, oil in crankcase, water or antifreeze in cooling system, and air in tires.

b. Safety precautions concerning the handling of gasoline must be rigidly enforced.

c. In the replenishment of oil in the crankcase, the following rules should be observed:

(1) Take every precaution to prevent dust and other foreign matter from entering the crankcase with the oil. Wipe out the oil measure, the spigot on the oil drum, the funnel, and the oil filler pipe with a clean cloth before refill oil touches any of the surfaces.

(2) Pour only the proper amount of oil into the crankcase; do not overfill.

(3) Use the proper grade of oil for the season.

(4) Wipe off any oil spilled during refilling.

d. The water in the radiator should be maintained at the proper height below the overflow pipe. An overheated engine should be allowed to cool before any considerable quantity of water is added to the radiator, or the engine should be allowed to run and the water added very slowly. In freezing temperatures, if no antifreeze is used, care must be exercised to prevent freezing. When the cooling system must be drained, it is necessary in most engines that the cylinder block as well as the radiator be drained. Clean water, preferably soft, should be used to fill the cooling system. If conditions make it necessary to use dirty water, the cooling system should be drained, flushed, and refilled with clean water at the earliest opportunity.

e. Tire inflation is discussed in paragraph 26.

■ 22. LUBRICATION (see TF 25-76 and FS 10-39).—*a.* A full discussion of lubrication in general will be found in section V, chapter 7. This paragraph pertains only to the responsibilities of the driver under the system of decentralized lubrication. In decentralized lubrication, the driver should be held responsible for the lubrication of all parts that cannot be damaged by overlubrication, except those requiring special lubricants. Parts that should be lubricated by the driver include spring and spring shackle bolts, spring pivot seats, steering knuckle pivots, steering knuckle tie rod pins, steering gear connecting rod (drag link) ends, clutch and brake pedal and brake lever pivots and linkage, accelerator linkage, door hinges and locks, tail gate hinges, and other slow motion friction surfaces.

b. Equipment furnished the driver includes a high pressure lubricator and an oilcan.

c. Lubrication should be performed in accordance with a lubrication schedule prepared by organization mechanic or motor sergeant, and reports should be rendered by drivers when the lubrication is completed in order that proper records may be kept. Grease fittings and oil holes should be cleaned before lubricant is applied. Careful instruction and diligent supervision are necessary to assure good lubrication. Lubrication by the numbers is suggested as an effective method for teaching lubrication to untrained personnel.

d. Lubrication by drivers involves the use of only two types of lubricant—oil and chassis lubricant.

(1) The oil used for lubrication of linkages, hinges, etc., should be of the same grade as that used in the engine crankcase.

(2) The chassis lubricant used on spring and spring shackle bolts, steering knuckle pivots, etc., is of semifluid grease usually having a brilliant color and stringy consistency.

■ 23. TIGHTENING.—*a.* The distinction between tightening and adjusting must be definitely understood, otherwise drivers will undertake operations which they do not have the knowledge, experience, or equipment to perform. In general, adjustment involves placing moving parts or assemblies in proper relative position and securing them in that position. Adjustments, except specified emergency adjustments, are prohibited to the driver. On the other hand, tightening consists of drawing up nuts and screws when adjustments are not involved.

b. When a driver discovers a loose or lost nut, bolt, screw, stud, or cotter key, he should tighten or replace it unless the adjustment of a part or assembly is affected. If adjustment is involved, report should be made to the chief of section or other designated individual.

c. A driver should be taught the correct use of the tools furnished for his use and the proper degree of tightness of the various nuts, bolts, and screws on his vehicle. If the drivers are not sufficiently skilled, or if the proper tools are not furnished for their use, all tightening operations should be performed by the motor sergeant and mechanics.

■ 24. CLEANING.—*a.* A motor vehicle should be cleaned after operation to prevent hardening of dirt accumulations and to keep dust and other foreign particles from working into bearing surfaces. The body and exterior parts of the chassis should be washed, using a hose if available. Water should not be played on the engine as ignition troubles may result. Dirt should be wiped from the engine and its subunit assemblies. Gasoline will never be used as a cleaning agent; cleaning solvent is recommended because of its greater safety. Gas and oil lines should *not* be polished, since pressure incident to polishing is apt to loosen or break the joints. The use of paint on radiator cores is prohibited, as it retards the cooling action of air streams passing through the core.

b. Unless the vehicles are very dirty, they should be inspected *before* being washed. This facilitates the detection of loose parts and assemblies, because broken dust films are the best evidence of looseness. Scheduled lubrication should be performed *after* washing so that any water or dirt which has entered bearing surfaces may be forced out by the pressure of the new lubricant.

c. The decontamination of vehicles after a gas attack is discussed in FM 21-40.

■ 25. CARE OF TOOLS AND EQUIPMENT.—The driver is responsible that tools, spare parts, pioneer equipment, chains, traction devices, towing cables, paulins, fire extinguisher, and other equipment furnished with his vehicle are in their proper places, are clean, and are in condition at all times for immediate use. Any equipment which becomes unserviceable should be repaired or replaced immediately. Shortages or unserviceable equipment should be reported to the chief of section, motor sergeant, or other designated individual.

■ 26. CARE OF TIRES (see TM 31-200).—a. The chief responsibility of the driver in caring for tires is that of proper inflation. Tires should be inflated to recommended pressures and the pressure checked daily with a reliable gage. Air pressure cannot be determined satisfactorily by looking at the tire.

b. Wheels, including spares, should be changed periodically to secure uniform tire wear and to maintain resiliency in the spare tires.

c. Drivers are also responsible for changing of tires and in emergencies, the cold patching of tubes. When mounting tires on a motor vehicle, particular attention should be paid to sizes. In general, tires should be mounted in pairs. That is, tires of equal outside diameter should be mounted on the front wheels and those of equal outside diameter on the rear wheels of a 4 by 2 vehicle. However, on an all-wheel-drive vehicle without a center differential or other compensating device, all tires should have the same outside diameter. In order to maintain this condition after tires become worn, it may be necessary to transfer tires from one vehicle to another.

d. When mounting dual tires, the worn tire should be placed on the inside. Tires differing more than $\frac{1}{2}$ inch in

outside diameters should not be mounted on the same wheel or on the same axle.

e. Drivers should be constantly alert to detect evidence of excessive or unusual tire wear. The most common causes of excessive tire wear are—

(1) Improper inflation, including under and over inflation and "bleeding" (loss of air from slow leaks and missing valve caps).

(2) Poor driving, including fast starting and stopping and improper use of brakes.

(3) Rocks or other foreign material wedged in tire treads and between dual tires.

(4) Misalignment, due to loose wheel lugs, or incorrect alinement of front wheels.

(5) Overloading and improper loading.

(6) Improper sizing of tires (different sized tires on the same axle).

■ 27. CARE OF STORAGE BATTERY (see TF 25-75).—The motor vehicle driver should have a general knowledge of the functioning of a storage battery. He should know the ammeter reading which indicates proper functioning of the generator and the general procedure to be followed when any abnormal reading is observed. He should know how to use the storage battery so as to prolong its period of usefulness. The following care by the driver should be routine:

a. Keep battery terminal connections clean and tight. Remove and clean corroded connections, using a weak alkaline solution if available. Dry the connections, apply a thin coating of vaseline or soft grease, replace and tighten the connections. Corroded terminal connections and battery cables reduce storage battery efficiency and overload the generator, and should be replaced.

b. Keep the battery clean and securely clamped in the battery carrier.

c. Inspect the height of the battery electrolyte each week during the summer season and every 2 weeks during the winter season. If the electrolyte is below the prescribed level, report the fact to the chief of section or other designated individual.

d. Report any unusual performance or battery condition immediately.

■ 28. DUTIES DURING SCHEDULED MAINTENANCE AND TECHNICAL INSPECTIONS.—*a.* Before his vehicle is submitted for scheduled maintenance or technical inspection, the driver should correct such mechanical defects as are within the limits of his ability and the tools and equipment provided for his use. The vehicle should not be cleaned unless it is excessively dirty, since the dust film aids the mechanics in detecting defects.

b. The driver should report known mechanical defects which he is not authorized to correct and accompany his vehicle while it is undergoing scheduled maintenance or technical inspection in order to further his knowledge of the mechanical condition of the vehicle and to permit the motor officer, or his representative, to point out results of improper operation or vehicle abuse and take proper corrective action.

■ 29. REPORTS.—*a.* Driver's reports generally applicable to all arms and services operating and maintaining motor vehicles are (AR 850-15)—

(1) Driver's Report—Accident, Motor Transportation (Standard Form No. 26).

(2) Driver's Trip Ticket and Performance Record (W. D., Q. M. C. Form No. 237).

b. In case of injury to person or property, the driver of a motor vehicle will stop the vehicle and render such assistance as may be needed, complying with State and local regulations relative to reporting accidents. He will fill out immediately at the scene of the accident Standard Form No. 26 and deliver it to his commanding officer immediately upon return to his station. This must be done in every case regardless of how trivial the accident may appear to be or whether Government property or personnel only is injured (AR 850-15). Proper use of the accident report form protects the careful driver in that it presents data secured immediately after the occurrence of the accident and permits completion of an investigation before facts become distorted.

c. A properly completed driver's trip ticket furnishes valuable data for organization maintenance records as well as a written report of performance defects and emergency repairs effected. The report of defects protects the driver and facilitates repair by shop maintenance personnel. When driver's trip tickets are not used, an oral report should be made by the driver.

■ 30. EMERGENCY ROADSIDE REPAIRS.—*a.* Emergency roadside repairs are limited by the ability of the driver and the tools, supplies, and equipment available for his use.

b. In performing emergency repairs, the driver should not force any part nor attempt the repair unless he is reasonably certain that he has diagnosed the trouble correctly. Tampering with mechanisms is prohibited. At the first opportunity after an emergency repair has been effected, the driver should report the fact to his chief of section or other designated individual in order that proper action may be taken. The following are examples of emergency roadside repairs which a driver should be permitted to perform after he has received proper training:

- (1) Remove, clean, reset, and install spark plugs.
- (2) Adjust fan belt.
- (3) Remove, blow out, and install gas lines.
- (4) Tighten nuts.
- (5) Tape leaks in gas or oil lines and tighten connections.
- (6) Drain and clean the sediment bowl of the carburetor or fuel pump.
- (7) Tape electrical lines.
- (8) Plug leaks in the cooling system and tighten water-pump connections.
- (9) Loosen tight brakes, subject to inspection by organization mechanic at first opportunity.
- (10) Change tires and put cold patches on tubes.

■ 31. DRIVER'S INSPECTION BEFORE OPERATION.—A motor vehicle is not ready for service until certain items have been checked. Before moving his vehicle from its overnight parking position, the driver, under proper supervision, makes this inspection and reports the results to his chief of section or other designated individual. The driver is held strictly responsible that all requirements are met. Items are checked as follows:

a. Before starting engine.

- (1) Surface (ground or floor) under the vehicle for evidence of leaks.
- (2) Radiator for proper amount of water and to see that air passages are open.
- (3) Crankcase for proper amount of lubricating oil. Add oil if required; spare oil should be carried for use in emergencies.

- (4) Engine for loose parts or electrical connections.
- (5) Gasoline tank for proper amount of gasoline.
- (6) Fan belt for proper tension, and for fraying, or splitting.
- (7) Drain valve in air-brake storage tanks closed.
- (8) Hand brake set and all transmissions and power take-offs in neutral.

b. After starting engine and during warm-up period.

- (1) Proper functioning of all gages on instrument panel, including air-pressure gage, as engine comes to operating temperature.
- (2) Horn and all lights for proper functioning.
- (3) Action of the windshield wiper.
- (4) Fan operation.
- (5) Engine for loose parts and unusual noises.
- (6) Front axle and steering linkage.
- (7) Tools and necessary equipment, including fire extinguisher.
- (8) Carried load for condition and distribution.
- (9) Towed load for condition, attachment to truck, and brake connections.
- (10) Pneumatic tires, including spares, for proper condition and inflation.
- (11) Wheels for tightness.
- (12) Springs for condition.
- (13) Recheck for water, oil, and gasoline leakage.
- (14) Move vehicle and test the clutch, transmission, steering, and brakes.

■ 32. DRIVER'S INSPECTION DURING OPERATION.—*a.* During operation the driver should be alert to detect malfunctioning of the engine and all operating assemblies, including clutch, the power transmission system, and brakes. He should be trained to detect unusual engine sounds or noises and to follow the proper procedure when they occur. He should glance frequently at the instrument panel gages and know what to do when abnormal readings are observed. The most common abnormal readings are—

- (1) Ammeter showing discharge when engine is running.
- (2) Oil pressure gage showing abnormally high or low readings, or the needle fluctuating.
- (3) Temperature gage reading 200° F.

(4) Gasoline gage failing to show correct amount of gasoline.

(5) Air gage reading less than 70 pounds.

b. A motor vehicle will not be operated after trouble has developed which will prove serious, if operation is continued. When in doubt, the engine should be stopped and assistance obtained. Inspection during operation applies to the entire vehicle and should be emphasized throughout the driving instruction period.

■ 33. DRIVER'S INSPECTION AT HALT.—At each scheduled halt during the march, or at intervals during a day's work on dispatch, the driver should make a careful inspection of his vehicle to determine its general mechanical condition, reporting defects which he cannot correct. A suitable general routine, the sequence of which may be altered to suit a particular type of vehicle, is as follows:

a. Allow the engine to run a short time; listen for unusual noises.

b. Check all items included in the "inspection before operation" (par. 31).

c. Feel brake bands, wheel hubs, and gear cases for evidence of overheating.

d. Report promptly the result of the inspection to the chief of section or other designated individual.

■ 34. INSPECTION AFTER OPERATION.—At the conclusion of the day's work, the driver should make an inspection similar to that made at halts, but more thorough and detailed. If defects cannot be corrected, they should be reported promptly to the chief of section or other designated individual. A suitable routine is as follows:

a. Check all items included in the inspection at the halt (par. 33).

b. Check body bolts; tighten or replace as required.

c. Drain air tanks to extent necessary to blow off condensed moisture.

SECTION IV

DRIVING INSTRUCTION

■ 35. GENERAL RULE.—Careful instruction and painstaking supervision must be the rule during the driving instruction period to insure that the driver learns the correct performance

of his duties and forms the proper habits. A driving course, properly laid out and organized, will be of great aid to instructors and will be used when time and facilities permit. (See app. II.)

■ 36. MOTOR VEHICLE CONTROLS.—The day-to-day condition and the ultimate service of a motor vehicle, as well as safety to life and property, depend upon the condition and proper use of the controls. Consequently, instruction and supervision, as well as continued practice, are necessary to insure the correct use of these important devices. The following controls should be explained and demonstrated:

- a. Carburetor choke control (if not automatic).
- b. Carburetor throttle control, to include accelerator.
- c. Ignition switch.
- d. Spark control (if not automatic).
- e. Transmission gearshift lever.
- f. Transfer gearshift lever.
- g. Clutch pedal.
- h. Steering wheel.
- i. Brakes, hand and foot.
- j. Power take-off and winch controls.
- k. Front wheel declutching lever.

■ 37. AIDS TO MOTOR VEHICLE CONTROL.—Although the devices given below cannot be classed as controls, they aid in motor vehicle control and should be explained and demonstrated.

- a. Light switches.
- b. Horn button.
- c. Rear view mirror.
- d. Windshield wiper.
- e. Speedometer.
- f. Blackout devices.

■ 38. INSTRUMENT BOARD GAGES.—Gages are placed on the instrument panel in plain view of the driver to give information concerning certain assemblies and systems of the motor vehicle. The instructor should explain the purpose of each gage, give its normal reading, and tell the driver what to do when an abnormal reading is observed.

■ 39. STARTING AND WARMING UP ENGINE.—a. Special attention should be paid to the proper starting and to the warm-up period in order that unnecessary engine wear may be pre-

vented. In this connection, the Technical Manual (manufacturer's instructions) furnished with the vehicle will be followed closely. In general, the following procedure is satisfactory:

(1) Make the prescribed inspection before starting engine (par. 31a), including setting the hand brake and placing all transmissions and power take-offs in neutral.

(2) Set the choke control (unless automatic), and the hand throttle control. Consider the peculiarities of the engine, engine temperature, fuel, and manufacturer's instructions. Care should be taken to avoid excessive use of the choke.

(3) Disengage the clutch.

(4) Turn on the ignition.

(5) Engage the starter switch contacts. Release the starter switch contacts as soon as the engine starts.

(a) If the starter device fails to engage the engine flywheel, release the starter switch contacts and allow the starter armature to come to rest. To avoid damaging the electric starter assemblies, always make sure that engine has not been started before depressing starter switch. Try again. If the device still fails to engage, report to the chief of section or other designated person.

(b) If the starter device engages the engine flywheel and locks, release the starter switch contacts, turn off the ignition, place the transmission in high gear, release the brake, and rock the vehicle backward. If the starter device fails to disengage, place the transmission in neutral and report as above.

(c) If the starter device engages the engine flywheel and the engine fails to start after several attempts, note whether or not the ammeter needle fluctuates, then report as above.

(6) If the engine is magneto equipped and hand cranking is necessary, follow the manufacturer's instructions.

(7) While the engine is running, adjust the setting of the dash throttle control to give the desired engine speed. Release the clutch pedal.

(8) Allow the engine to warm up to the proper operating temperature, releasing the choke as rapidly as the engine temperature permits. *The choke should be used only as long as necessary and should never be used excessively.* The engine has reached a safe operating temperature when upon acceleration there is no backfiring, and when the oil pressure needle remains below the maximum reading on the oil pressure gage:

scale with the engine running at its normal operating speed. In case an abnormal reading is noted, an immediate report should be made.

b. Some engines, when stopped after reaching an operating temperature, radiate enough heat to cause boiling of the gasoline in the carburetor float chamber. This condition, which is not uncommon during hot weather operation, causes a rich mixture in the intake manifold. To start the engine, the hand throttle is fully opened, the carburetor choke is left in the normal operating position, and the engine started. The throttle should be adjusted to the desired engine speed only after the engine begins to run smoothly. Intermittent depression of the accelerator when the engine is not running will also produce a rich mixture in the intake manifold; the procedure outlined above should be followed in starting the engine.

■ 40. MANIPULATION OF CONTROLS.—a. Drivers should familiarize themselves with the location and manipulation of the clutch pedal, the transmission gear shift lever, and the brake lever and brake pedal before actual driving instruction starts.

b. When the candidate first gets into the driver's seat he should be required to assume the correct position; that is, sit erect, without stiffness, squarely behind the steering wheel; head erect, eyes looking to the front; hands on opposite sides of the steering wheel, on a horizontal line generally through the center of the wheel, grasping the steering wheel rim firmly but without tenseness; both feet flat on the floor boards except when actually manipulating the accelerator, the clutch and brake pedals, or the starter switch. *The feet should be placed on the control pedals only when the pedals are to be operated.*

c. After the candidate has familiarized himself with the location and manipulation of the controls, the instructor should start and warm up the engine. He should then demonstrate the operation of the accelerator; coordinated movements of the accelerator, clutch pedal, and transmission gear shift lever; gear shifting, to include reverse; operation of the brake controls; manipulation of the steering wheel; and the use of the engine as a brake. Upon completion of the demonstration, the candidate should take the driver's seat and under careful supervision, practice ma-

nipulating the controls until he becomes reasonably proficient. In this phase of instruction, the motor vehicle should be blocked up securely with wheels off the ground.

■ 41. GEAR SHIFTING AND USE OF CLUTCH.—*a. General.*—Preliminary instructions in driving should be conducted on a large, open field where steering is of secondary importance. Candidates should be permitted to drive at will with the transmission in the lower gear ratios until they are reasonably familiar with the operation and control of their vehicles, after which the driving should become progressively more difficult.

b. Shifting from lower to higher gear.—In shifting from a lower to a higher gear without double clutching, the following operations are performed:

(1) Disengage the clutch and at the same time release the accelerator. The operation of the clutch and the importance of completely disengaging it should be understood.

(2) Shift to the next higher gear. The gear shift lever should be moved smoothly but firmly; it should never be forced.

(3) Engage the clutch and at the same time accelerate the engine.

(a) The clutch must be released gradually from the time it starts to engage until it is fully engaged. Since the clutch action takes place during a relatively short movement of the pedal, the driver must know the point at which engagement starts. He can then increase the engine speed to balance the engine load. He must also know the injurious effects of allowing the foot to remain on the clutch pedal ("riding the clutch").

(b) The engine should be accelerated enough to move the load off smoothly, but it should not be raced. During the preliminary instruction period, the accelerator may be blocked to prevent excessive engine speed.

c. Shifting from higher to lower gear.—After the driver has become reasonably proficient in shifting from lower to higher gears, he should receive instruction in shifting from higher to lower gears, using double clutching. The procedure is as follows:

(1) Disengage the clutch and shift to neutral; at the same time decelerate the engine.

(2) Engage the clutch and accelerate to an engine speed slightly in excess of that required in the lower gear to maintain the vehicle speed.

(3) Disengage the clutch and shift to the next lower gear; at the same time slightly decelerate the engine.

(4) Engage the clutch; at the same time accelerate the engine to effect clutch engagement without shock to the power transmission system.

(5) Practice double clutching until proficient in shifting from a higher to a lower gear.

d. Shifting gears on medium and heavy trucks.—On medium and heavy vehicles it is sometimes difficult to shift from a low gear to a higher gear without clashing the gear teeth. The clashing may be avoided by using the double clutching procedure *without accelerating the engine during the shift.*

■ 42. USE OF TRANSMISSION AND AUXILIARY TRANSMISSION.—*a.*

A transmission is provided so that the engine may be permitted to run at a speed at which sufficient horsepower is developed, and at the same time permit the vehicle to travel at a speed suitable for the road and load conditions. The addition of auxiliary transmission, usually included as a part of the power transmission system on 4- and 6-wheel-drive vehicles, increases the number of gear ratios available and permits greater flexibility in the transmission of power.

b. The driver should understand what happens when the gear shift lever is moved and must be practiced in the manipulation of the controls and the proper use of the transmission and auxiliary transmission. He should be instructed to shift gears at the proper time so that the engine will never be permitted to labor unduly when a change from a higher to a lower gear would lighten the load. If his vehicle is equipped with a tachometer, he should know the proper engine speeds for efficient operation.

c. The auxiliary transmission normally provided on military motor vehicles has two gear ratios: high, which does not change the gear ratios provided by the main transmission; and low, which gives a greater gear reduction (higher reduction ratio) than that provided by the main transmission. The auxiliary transmission is controlled by a gear shift lever in the driver's compartment. The high range is

used for normal operation and the low range for heavy duty. *The ratios in the auxiliary transmission of most types of vehicles should not be changed when the vehicle is in motion.*

■ 43. USE OF BRAKES.—*a.* The brakes should be in such condition that a hard application will cause all wheels to be locked, but the driver must realize that the maximum retarding effect occurs just before the wheels lock. Intermittent applications will reduce the wear of brake linings and drums. Application of the brakes should be gradual and with just enough force to accomplish the desired result.

b. Judicious use of the braking effect of the engine will increase the serviceable life of the brake linings and drums. When the driver anticipates a stop, he should make full use of the engine braking effect, disengaging the clutch in time to avoid stalling the engine. When descending hills, a driver should use the engine as a brake by selecting and engaging the proper gear ratio, and use the intermittent application of the brakes to prevent overspeeding the engine. The ignition should not be turned off. The engine speed when descending a hill should be no greater than the speed necessary to ascend the hill when using the same transmission gear ratio. On steep hills the gear train necessary to give the desired results should be engaged before the vehicle is committed to the hill. Attempting to shift gears after the vehicle has started down a steep slope may result in a runaway vehicle. In descent of long, steep hills, the vehicle should be halted occasionally to avoid too rapid cooling of engine when used as a brake.

c. At all times a driver should know the performance and the general condition of his vehicle brakes. When operating conditions require vehicles to move through water, the brakes become very inefficient because of moisture on the brake linings and in the brake drums. If the distance to be traversed is short, considerable water may be kept out of the brake assemblies by a slight application of the brakes while the vehicle is in the water. After passing through water, the brakes should be set slightly and the vehicle operated until sufficient heat has been generated to dry the brakes. Brakes should be thoroughly cleaned after extended driving in soft mud.

d. Vehicle stopping distances are dependent upon the nature

and condition of the road surface, the condition of the brakes, the weight of the load, and the kind and condition of tire treads. When operating at a speed of 20 miles per hour on a dry, smooth, level road free from loose material, every motor vehicle or combination of motor vehicles should be capable, at all times and under all conditions of loading, of stopping within the following distances when the foot brake is applied:

(1) Vehicles or combination of vehicles having brakes on all wheels—30 feet.

(2) Vehicles or combination of vehicles not having brakes on all wheels—45 feet.

e. Drivers should be cautioned against the use of brakes when a vehicle is skidding, and when it is being operated on ice-covered or wet surfaces. Such surfaces afford little gripping action for tires. A sharp application of the brakes will lock the wheels, causing the vehicle to skid. The braking action of the engine should be used to the utmost, declutching only in time to prevent stalling the engine.

■ 44. TURNING, BACKING, AND PARKING.—*a.* After the driver has acquired facility in starting, simple driving, and stopping his vehicle, he should be practiced in maneuvering in difficult places. The ability to turn his vehicle in a confined space, to back it accurately, and to park it properly under various conditions are essential requirements for the motor vehicle driver.

b. Turns should be made at speeds commensurate with the load, road, and traffic conditions. The driver should always give the appropriate arm, electrical, or mechanical signal in sufficient time to afford ample warning that a change in direction is to be made. He should keep at least one hand on the steering wheel when the vehicle is in motion. Turns should be made with as little confusion to other traffic as possible. On 2-lane highways, all turns should start and end in the right lanes. On multiple-lane highways, right turns should start and end in the extreme right lanes; left turns should start and end in the lane just to the right of the center line. The driver should place his vehicle in the proper lane some distance before reaching the turn in order to avoid the possibility of accidents.

c. A driver should never back a vehicle until he is certain that the way is clear. When the driver's view is obstructed, he should act as directed by an assistant on the ground.

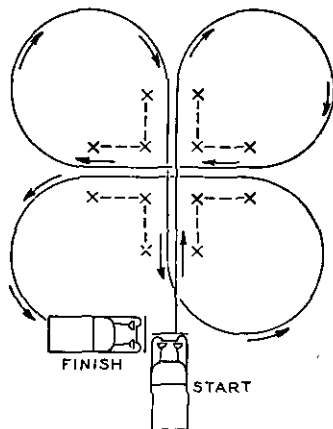

(The figure should be symmetrical, with the stakes placed to allow a side clearance of approximately 18 inches on the turn. Actual placement of the stakes should be determined from the performance of a pilot vehicle, since the total space required for the turn depends upon the type of vehicle used.)

FIGURE 2.—Reverse turning course.

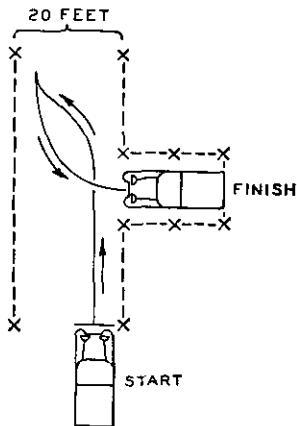

(The figure should be symmetrical, with the stakes placed to allow an over-all side clearance of approximately 18 inches at the finish. The entering lane should be wide enough to permit the movement if it is executed correctly.)

FIGURE 3.—Backing course.

When backing unassisted, the driver should always give warning of the movement by sounding his horn. Considerable practice is necessary to back a vehicle safely and accurately. This is particularly true when the driver is required to back a towed load.

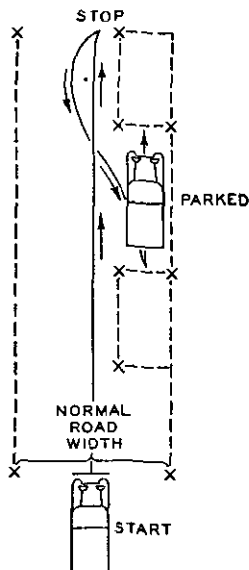

(Stakes should be placed so that when parked the vehicle will have an over-all longitudinal clearance of approximately 10 feet and a lateral clearance of approximately 3 feet.)

FIGURE 4.—Parking course.

d. Parking includes turning and forward or backward movement of the vehicle in more or less restricted spaces. Factors which should be given consideration when parking are space for maneuver of vehicle, solid standing, interference with other traffic, and cover if applicable.

e. The use of driving courses outlined by stakes will permit instruction and practice without interference with other traffic and will make closer supervision possible. The instruction courses shown in figures 2, 3, and 4 are recommended.

■ 45. DIFFICULT DRIVING.—a. After the driver has acquired facility in driving and maneuvering, he should be taken

through a series of progressively increasing difficulties, such as ditches, ruts, chuckholes, woods, slippery roads, mud, difficult curves, and up and down steep slopes until he becomes reasonably proficient in handling his vehicle under all conditions. This training should include field expedients and the application and use of chains and traction devices. (See ch. 6.)

b. The training should start with individual performances and empty vehicles and should progress to group performances with loaded vehicles, and with towed loads if used in the organization.

■ 46. NIGHT DRIVING.—*a.* Movements under cover of darkness are frequently necessary in order to escape observation and gain security. In forward areas, movements must be made without lights if casualties are to be minimized and secrecy preserved. Before such movements are undertaken, drivers should be given thorough training in marching, with and without lights.

b. Training in night driving should start with empty vehicles operated over good roads with lights. Careful instructions should be issued, and the road should be well marked. After the drivers have become reasonably skilled in driving with lights, they should be required to traverse the same route without lights. Provision should be made to prevent flashing of the stop light. The routes traversed should become progressively more difficult until drivers are proficient in handling their vehicles under all probable operating conditions. During this training, special attention should be paid to march discipline, to the prevention of smoking, and the use of lights. When a movement with lights is to be continued without lights, 15 to 20 minutes should be allowed to accustom drivers' eyes to the changed conditions.

■ 47. MARCHING.—*a.* Successful marching requires well-trained drivers and teamwork on the part of all elements of the command. Drivers must therefore be trained in march organization, march formations, march regulations, camouflage and concealment of vehicles, and procedure in case of air or mechanized attack (chs. 3, 4 and 5). Through instruction and the enforcement of regulations, a degree of march discipline is attained which enables an organization to pass over roads with a maximum of speed and safety, and a minimum

of interference with other traffic, and to arrive at its destination in the best possible condition.

b. During training in close-column marching (see par. 57), special attention should be paid to safe driving distances between vehicles. These distances, which vary with vehicle speeds, should be prescribed initially. The controlling element in the determination of safe driving distance is the ability to avoid collision with the vehicle ahead without the excessive or sudden use of brakes. During the early stages of training, the following rule, properly modified to meet special conditions, gives distances that are considered adequate for safe marching: *The distance in yards between vehicles should be twice the speedometer reading.*

SECTION V

EXAMINATION AND OPERATOR'S PERMIT

■ 48. EXAMINATION (AR 850-15).—Motor vehicle operator's permits will be issued only to individuals who have satisfactorily passed an examination conducted by a qualified commissioned officer. Suitable types of examination are shown in appendixes III and IV. The following subjects should be included:

a. *Mechanical.*—Nomenclature and functions of major units of the motor vehicle.

b. *Operation.*—(1) Actual driving of the vehicle, involving use of controls, reversing, and parking under usual conditions of traffic and terrain.

(2) Traffic regulations, road procedure, safety precautions, speed limits, vehicle abuse, and reading of road maps.

c. *Maintenance.*—First echelon (vehicle operator's) maintenance.

■ 49. OPERATOR'S PERMIT (AR 850-15).—a. W. D., Q. M. C. Form No. 228 (U. S. Army Motor Vehicle Operator's Permit) will be issued by commanding officers to all operators of military motor vehicles, and will indicate the type of vehicle the holder is qualified to drive.

b. Possession of a motor vehicle operator's permit should be a guarantee that the individual is a safe driver. Accordingly the permit will be immediately revoked when an accident or other cause so warrants.

CHAPTER 3

MOTOR MARCH

	Paragraphs
SECTION I. General.....	50-54
II. Types of march.....	55-59
III. March technique.....	60-71
IV. Orders.....	72-75

SECTION I

GENERAL

- 50. **SCOPE.**—This chapter is concerned principally with the internal management of the individual motor column.
- 51. **DEFINITIONS.**—*Arrival time.*—The time at which the head of a column, or specified element thereof, arrives at a designated point.
- Control point.*—A definite, easily identified and described location along a route of march, at which information and instructions are given and received in order to facilitate and regulate supply or traffic.
- Clearance time.*—The time at which the tail of a column, or specified element thereof, completes passage by a designated point.
- Column.*—One or more march units, or serials, under one commander using the same route.
- Column commander.*—The senior officer with the column or the person designated by him to exercise command.
- Control car.*—The car which precedes a column, or element thereof, and sets the rate of march.
- Control officer.*—An officer, usually the executive or second in command, who rides at the head of a column, or element thereof, and regulates the rate of march.
- Convoy.*—A group of motor vehicles temporarily organized to operate as a column for the purpose of transporting non-organic troops or supplies, in contradistinction to organically motorized tactical units or supply trains.
- Distance.*—The space from the rear of one vehicle (including towed load, if any) to the front of the next vehicle in the column; or the space from the rear element of a march

unit or serial to the leading element of the following march unit or serial.

Double staggered column.—A two-lane column of vehicles moving in same direction so arranged that the vehicles in one lane are opposite the spaces between vehicles in the other lane. (See fig. 7.)

Double banking.—The act of overtaking and passing, or parking or moving abreast of, other traffic headed in the same direction on a roadway.

Entrucking point or detrucking point.—An easily recognizable location where the head of a motor column, or element thereof, halts for the loading, or unloading, of troops or supplies.

Escort.—Troops detailed to prevent interference with a motor movement by hostile air forces, by mechanized or other ground forces, or by other traffic.

Guard.—An individual placed at a danger point, such as a railroad crossing or a turn into or off a main road, to prevent traffic accidents.

Guide.—An individual who leads or directs a unit or vehicle over a predetermined route or into a selected locality.

Headway.—The interval of *time* between individual vehicles, march units, serials, or columns, measured from head to head as they pass a given point.

Initial point (IP).—An easily recognizable point at which a column, or element thereof, is formed by the successive arrival thereat of its various subdivisions.

Lead.—Linear spacing between the heads of successive vehicles, serials, march units, or columns.

March graph.—A time-space diagram used in planning and controlling marches and in preparing or checking march tables or march control tables.

March order.—An order issued by a commander, covering the details of a march.

March table.—A composite list showing the general-organization and time and space schedule for a march movement. (See par. 130.)

March unit.—One or more motor vehicles under a single commander for purposes of march control. A company, troop, battery, or similar organization normally forms the march unit.

- Marker.**—An individual, distinctive sign, or notice placed at a critical location to indicate a position, direction, procedure, or obstacle.
- Park.**—An area used for the purpose of servicing, maintaining or parking vehicles.
- Pioneer work.**—Rough, hasty construction or demolition tasks executed to facilitate the movement of friendly troops or to impede the movement of hostile troops.
- Rate of march.**—The average speed of a column over a period of time including short periodic halts.
- Regulating point.**—An easily recognizable location where an incoming motor column, or element thereof, is separated into groups for movement to assembly or bivouac areas, or to entrucking or detrucking points.
- Release point.**—A location at which specified elements of a column revert to control of their respective commanders.
- Road block.**—Any obstacle which delays or prevents traffic movement on the road.
- Road space (RS).**—The total length of roadway occupied by a column or element thereof.
- Road time.**—The total time a column, or element thereof, requires to clear a given section of road. (Road time= $\frac{\text{time length}}{\text{time distance}}$ between ends of the given section of road.)
- Serial.**—One or more march units, preferably with same march characteristics placed under one commander for march purposes.
- Shuttling.**—A method of moving troops and matériel in repeated trips by same motor vehicles.
- Speed.**—A rate of travel, usually measured in miles per hour.
- Speedometer multiplier (sm).**—Any number by which the speedometer reading in miles per hour is multiplied to determine intervehicular lead in an open column (see par. 58).
- Strip map.**—A sketch or map, either schematic or drawn to scale, delineating a route to be followed; sometimes in the form of a section or strip, cut or reproduced from a map.
- Time distance.**—The time required to move from one point to another at a given rate of speed.
- Time-gap.**—The interval of time between successive vehicles, march units, serials, or columns as they move past a fixed point, measured from tail to head.

Time length (TL).—The time required for a column, or element thereof, to pass a given point.

Traffic block.—Any use of a section of roadway by vehicles or traffic which prevents the passage of other vehicles or traffic in a specified direction.

Traffic bottleneck.—A section of traveled roadway having a greater traffic density, or a smaller traffic capacity, than that of the roadway or roadways leading thereto.

Traffic capacity.—The maximum traffic flow attainable with close column marching on a given roadway, using all available lanes.

Traffic density.—The number of vehicles per unit length of roadway (e. g., 75 per mile).

Traffic flow.—The number of vehicles that pass a given point within a given period of time (e. g., 500 vehicles per lane per hour).

Trail car.—The car carrying the trail officer.

Trail officer.—An officer, usually the motor maintenance officer, who rides at the rear of a column, or element thereof. (See par. 60 for duties of a trail officer.)

Turn-around.—A locality where the direction of march may be reversed.

Vehicle commander.—Usually the senior officer or man riding in the vehicle.

■ 52. COMMAND.—*a. Organically motorized tactical units.*—Movements of organically motorized tactical units are made under the direction and supervision of the senior commander in the column.

b. Organic supply column.—Motorized columns carrying organic equipment and supplies likewise move under the command of the senior officer or noncommissioned officer present in the column, and each individual vehicle is commanded by the senior officer or man riding therein.

c. Convoys.—Movements of troops or supplies in nonorganic vehicles are in absence of orders to the contrary, commanded by the senior line officer present. In this case the motor-transport officer accompanying the vehicles acts only as technical adviser to the commanding officer of troops. However, if the troop or supply movement is being handled by the staff of a higher headquarters as part of a large move, command arrangements are as follows:

(1) The motor-transport units are organized, staffed, and a commander of troops and a convoy commander are designated, by the higher headquarters ordering the move.

(2) The convoy commander designated by such orders is responsible both for the technical operations of vehicles and for the movement of the column. Orders to convoy-operating personnel in this case are given only by the convoy commander and his assistants.

(3) The commander of troops exercises no control over the movements of the convoy or of individual vehicles, except in a tactical situation; then the decision rests solely with him. The troop commander is in all situations responsible for the administration and discipline of the troops being transported.

(4) Whenever a tactical situation can be foreseen, the senior combat troop commander will be placed in command of the convoy, the motor-transport officer acting as his technical adviser.

■ 53. ORGANIZATION.—*a. General.*—The organization of a motor column depends primarily on the tactical and traffic conditions likely to affect its movement. The main column may be organized into serials and march units to facilitate column control. The management of the main column is handled by the column commander, assisted by the column control officer, the column trail officer, commanders of serials and march units, and such traffic control personnel as may be posted along the route. Necessary ambulances and medical personnel and necessary maintenance vehicles, equipment and personnel, accompany the column to care for march casualties. Detached parties, operating apart from the main column, are detailed to perform special duties in connection with the march. Such parties may be provided by a higher headquarters for general assistance to several columns, or they may be detailed from the march column itself. Often it will be possible to combine one or more of the groups indicated below. When so combined, they are collectively referred to as the "advance party."

b. Reconnaissance party.—A traffic reconnaissance should always precede a motor movement. Necessary reconnaissance in rear areas is usually provided by traffic personnel of division or higher units. However, when movements are to be made over unknown and unpatrolled routes, the column com-

mander should detail a reconnaissance party from his own column. It may often be desirable to assign this duty to the traffic escort or to the pioneer party. (Traffic reconnaissance is covered in pars. 86 to 96, incl.; see ch. 5 for tactical reconnaissance.)

c. Pioneer party.—Necessary pioneer work in preparation of the route is usually accomplished by engineer troops. Lacking these, this important work must be performed by a pioneer party detailed from the march column. The requirements for pioneer work vary greatly. They are negligible when moving over good roads, but become extremely heavy when moving cross country or over demolished routes. In any case an estimate must be made of personnel, tools, materials, and the time necessary for elimination and reduction of obstacles. (Pioneer work is covered in ch. 6.)

d. Traffic escorts.—The duties and employment of a traffic escort are listed in paragraph 111.

e. Quartering party.—The mission of a quartering party is to arrange for local purchase¹ of necessary supplies or services (such as rations, forage, water, firewood, bridge tolls, gasoline, oil, medical attendance, etc.) and to locate and lay out bivouac or assembly areas and unloading and parking facilities prior to arrival of the column. It also prepares a plan for the defense of the area. On arrival of the column, the quartering party assists the traffic escort or other traffic personnel in guiding units to their exact areas and arranges for the prompt relief and return of empty vehicles to their proper units. Suitable personnel for this party may include a supply and agent finance officer, one or more officers from each battalion and regimental staff, a representative from each company, troop, or battery, and other necessary assistants.

f. Clean-up party.—It is the duty of the clean-up party to inspect bivouac areas and halt sites after they are vacated by the column and to correct and report any deficiencies observed. In peacetime the officer with this party completes necessary paper work in connection with leased camp sites (see AR 35-6080 and 30-1415) and any claims arising from damage to private or public property (see AR 35-7020,

¹ See AR 35-320 (agent finance officer); AR 5-240 and 30-2210 (local purchase of rations); AR 5-240 (gasoline, oil, and motor repair parts); and AR 40-505 (civilian medical attendance).

35-7030, 35-7040, 35-7050, 35-7060, 35-7070, 35-7080, 35-7100, 35-7220, and 30-1430). On the road, this group follows the main part of the column and salvages disabled vehicles which the column trail officer has ordered abandoned. Vehicles permanently abandoned by the column trail officer are tagged (if this has not already been done) to indicate the unit to which they belong and to show the reason for their unserviceability; and a report is made to the supply service concerned, stating the location and general condition of such vehicles. Salvage is covered in detail in chapter 7. Other road duties of the clean-up party include the picking up of guides, guards, and markers missed by the main part of the column, the final investigation of accidents en route (see par. 70) and the disposition of dead or wounded abandoned by the column.

■ 54. SECURITY.—Protective measures for motor transport are covered in chapter 5.

SECTION II

TYPES OF MARCH

■ 55. MECHANICS OF COLUMN MOVEMENT.—*a. General.*—Whenever the tactical situation permits, a march column should be made up of vehicles with similar march characteristics, even if this requires the temporary separation of a tactical unit into two or more independent columns. When the tactical situation demands that a column be composed of vehicles with different march characteristics, the rate of march of the column is governed by the performance of the slowest vehicle. For march control purposes, *it is usually desirable to place the slowest vehicle at the head of the column.*

b. Speed variance within column.—It is theoretically possible for an entire motor column to move at a constant speed. Practically, however, a column of any length will cover simultaneously many diverse stretches of road and incidents of terrain, including hills, sharp curves, dust clouds, and varying road surfaces. The result is that different parts of the column, regardless of traffic conditions and vehicle performance characteristics, move simultaneously at different speeds. This produces accordion-like action and on a long hill or bad stretch of road serious conditions may result. On the near side of the obstruction, a long and constantly increasing mass of vehicles will accumulate and on the far side, the column will be elongated (fig. 5).

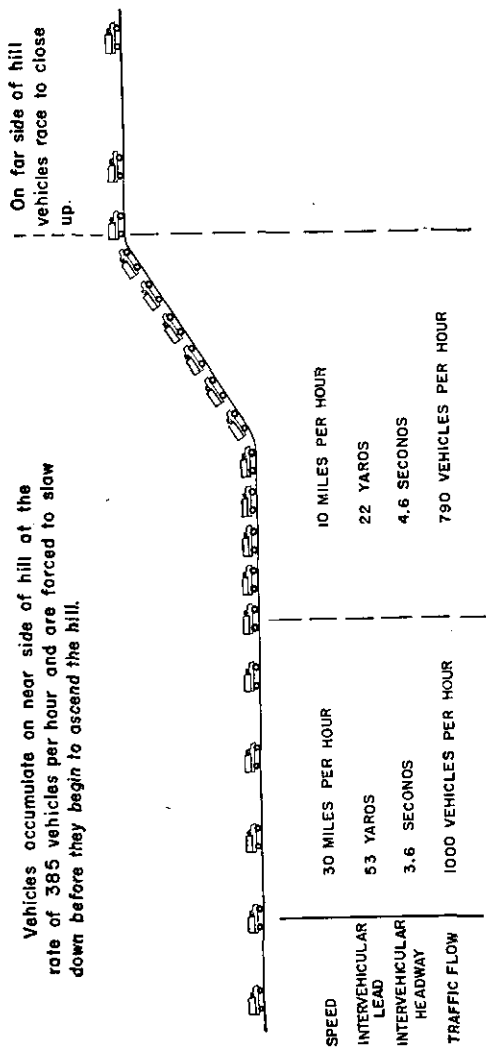

FIGURE 5.—Effect of hill or other traffic bottleneck on a close column (see par. 55).

c. *Solution to problem of column movement at varying speeds.*—(1) A long column can be held together under such conditions only by continuously adjusting the speed of the control car, and every succeeding vehicle in the column, to that of the vehicle moving at the slowest speed. Column compactness, if that is desired, can be attained only by sacrificing high rates of march. If compactness is not essential, *the ideal type of column movement is such as to permit each vehicle to pass over any given stretch of road at the same speed as the control car.* This ideal can be approached by varying intervehicular distances so as to produce constant headways throughout the column at all speeds. (See fig. 6.) When this is done the rate of traffic flow up to a section of road, which must be traversed at a reduced speed, is made equivalent to the rate of traffic flow over and away from this section of road. Intracolumn interference is thereby eliminated, and every vehicle in the column is enabled to move as rapidly as if there were no other vehicles on the road.

(2) In picking up speed after leaving the traffic bottleneck, the control car should *increase its speed gradually*, in order to mitigate the accordion action. If fixed intervehicular distances had been maintained by the column shown in figure 6, the entire column would have been forced to slow down as soon as the first vehicle began to ascend the hill. The slow movement would then have been continued until the last vehicle had completed its ascension of the hill. For a column 20 miles long, the result would have been to reduce the speed of every vehicle from 30 to 10 miles per hour over a road distance of 20 miles. With the type of column movement actually shown in figure 6, on the other hand, the rate of march of each vehicle is reduced from 30 miles per hour to 10 miles per hour only while ascending the hill. The nearer the approach to constant headways throughout the column, the nearer will be the approach to the ideal type of column movement. Variable intervehicular distances are used in all of the types of march described in the following paragraphs.

■ 56. INFILTRATION.—*a. Description.*—Vehicles are dispatched individually or in small groups over a carefully marked route. Observation from the air should discern what appears to be only normal or routine traffic. (See par. 122.)

Traffic flow is the same toward, through, and away from the hill. Therefore vehicles do not accumulate on the near side.

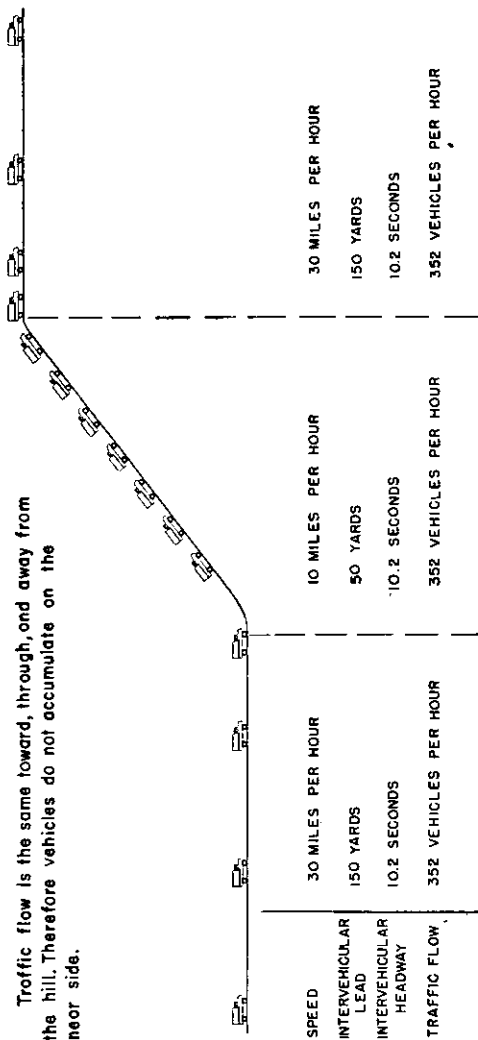

FIGURE 6.—Effect of hill or other traffic bottleneck on column moving with constant intervehicular headways (example shows an open column using an sm (speedometer multiplier) of 5).

b. *Uses.*—When sufficient time and road space are available, this type of march is used to provide the maximum of secrecy, deception, and dispersion as a means of passive protection against enemy observation and attack. It is therefore well suited to daylight marches in the combat zone. Because an infiltration column provides a minimum of interference with other traffic and a higher average rate of march, it is likewise suitable for nontactical motor movements in peacetime.

c. *Execution.*—(1) The route of march must be carefully marked, and every driver and front seat passenger should be given detailed instructions regarding it. A strip map should be provided for each vehicle. Complete operating instructions to include running speed, maximum speed, and restrictions on passing should be issued. Vehicles should be dispatched individually or in small groups of not more than 3 to 5 vehicles, and there should be no massing of vehicles which might disclose the movement to enemy observers.

(2) Deception may be further provided by intermingling various types of vehicles and by permitting passing within the column. In order to provide passive protection from enemy observation and attack, vehicles should normally be dispatched so as to produce an average traffic density (so far as the vehicles in the column are concerned) of not to exceed 10 vehicles per mile. (See par. 122.) When more than one movement is taking place simultaneously over the same route, it may be necessary to coordinate the rates of dispatch in order to obtain desired dispersion. Dispatching is normally effected by company, troop, battery, or similar unit in accordance with the plan of the column commander. Staff control can be exercised at the IP, but movements up to the IP must be planned so as to avoid an excessive concentration of vehicles near this point.

(3) Average headways between vehicles are determined initially by the rate at which vehicles are dispatched; thereafter, speeds and headways are regulated by individual drivers in conformity with operating instructions. These may include the use of a prescribed speedometer multiplier (open column marching) when slower speeds occur en route or minimum leads to avoid presenting remunerative targets from the air, orders of the vehicle commander, and instructions of traffic personnel. If it should become necessary for any part of the

column to halt on the road, vehicles should stop and pull off the road as soon as need for the halt is detected, and if possible, maintain distances of not less than 100 yards. Supervision of movement is effected by stationing necessary control personnel along the route of march. In order to prevent massing of vehicles at or near the march destination, it is important that adequate guides and markers be posted to insure that vehicles disperse to their assigned areas with minimum delay. (See par. 122.)

d. Advantages.—This type of march provides the best possible passive protection from hostile observation and attack. Under light traffic conditions, movement of individual vehicles is not affected materially by other vehicles in the column and is limited only by road conditions, vehicle mobility, and the training, experience, and physical condition of drivers. Thus, the rate of march is the highest practicable. Driver fatigue and the probability of accidents are reduced to a minimum. Since traffic density is normally very light, cross traffic can move without impeding the march. A traffic escort is not normally required, although intersection control may be desirable. Operating conditions resulting from the employment of the infiltration type of march approximate those to which individual drivers are accustomed in civilian traffic.

e. Disadvantages.—Time length of column is greater than with any other type of march. Thus, in spite of a higher rate of march, the total road time for a column may be longer. Because of extended distances between vehicles, internal control of the column is extremely difficult. Since drivers are not always able to regulate their movements on the vehicle ahead, careful marking of the route is necessary to prevent individual vehicles from getting lost.

■ 57. CLOSE COLUMN.—*a. Description.*—In this type of march, the column is formed as compactly as practicable in order to reduce its time length to a minimum. (See par. 122.)

b. Uses.—Close column is used when a large volume of traffic must be moved over short distances in a minimum period of time. It is also applicable to short, high-speed movements from cover to cover when a minimum time of exposure may reduce the chances of discovery and attack. Normally, however, close column is not justified except when the column is protected by an aerial escort or is otherwise

secure from hostile air attack. Close column may be useful for night moves under blackout conditions, particularly over poorly marked routes, when it is essential that distances between vehicles be short enough to enable drivers to maintain contact with and follow the vehicle ahead. This type of march may sometimes be used for peacetime movements through cities or other congested areas, providing that a traffic escort is available, the move has been coordinated with civilian traffic authorities, and the movement is important enough to warrant delaying civilian traffic. Because of the excessive intracolumn interference produced by close column marching, close column should never be used when open column will provide the desired traffic flow.

c. Execution.—When time and road space permit, sufficient headways (1 to 3 min. added to the time length of the preceding serial or march unit is normally ample) are prescribed between serials and march units to localize intracolumn interference, allow reasonably smooth marching, and provide a faster rate of march. If time or available road space makes it impracticable to divide the column into serials and march units, the entire column moves in one compact group as a single march unit (the so-called "follow me" method of marching). Within each march unit, drivers are instructed to follow the vehicle ahead as closely as they think is reasonable and consistent with safe driving practices. For purposes of safety, a maximum speed (greater than the average running speed) is prescribed for vehicles regaining lost distances. Changes in speed should always be accomplished smoothly and gradually in order to insure safety and uniformity of column movement. At the halt, unless the tactical situation prohibits congestion, vehicles within each march unit should close up to a distance of approximately 1 yard between bumpers. March units and serials, however, do not close on the units ahead. If a multiple lane road is available for a movement in a single direction, any number of lanes may be employed. However, since vehicles in a close column operate at minimum headways possible, there can be no weaving or interchange of traffic between lanes. A traffic escort is necessary when close column marching is used.

d. Advantages.—For any given speed, time length and road space of column are reduced to the minimum practicable, and the full traffic capacity of the road can be utilized. Because

of the small headways between vehicles, column control and intracolumn communication are the best obtainable. An aerial escort or active antiaircraft protection can be utilized to maximum advantage. Since time length of column is reduced to the minimum, short moves may be completed before enemy air units have time to strike.

e. Disadvantages.—This type of march does not provide dispersion for passive protection against enemy observation and attack. The strength and type of organization are readily apparent to hostile observation. In most cases, vehicles will arrive at terminal areas faster than they can be handled without producing congestion. Careful scheduling and rigid control of traffic are required if dangerous jams at intersections are to be avoided. Intracolumn interference is particularly troublesome and slows down the rate of march of the column.

■ 58. OPEN COLUMN.—*a.* In this type of column an effort is made to maintain approximately constant headways between vehicles at all speeds. Intervehicular leads should vary directly as the speed of movement. (See par. 122.)

b. Uses.—Open column is particularly applicable to tactical moves which must be made during daylight without aerial escort and when time is so important that lack of secrecy and reasonable losses from attack are acceptable. Sufficient dispersion may usually be prescribed to prevent simultaneous shelling or bombing of two or more vehicles. Open column may be used to advantage when moving with driving lights at night, or with blackout lights on moonlight nights. It is likewise applicable to nontactical peacetime marches if drivers must depend on vehicle ahead for route guidance, or when volume of traffic to be moved precludes the use of an infiltration march.

c. Execution.—(1) In order to give drivers a practical means of maintaining approximately constant time intervals or headways at all speeds, the lead in yards between vehicles in the column is indicated as *the product of the speedometer reading by a specified number called the speedometer multiplier (sm)*. Drivers and vehicle commanders are held responsible for maintaining specified *sm*. At slower speeds and with smaller speedometer multipliers, it is impossible to maintain the small leads necessary to provide constant head-

ways; at higher speeds and with larger speedometer multipliers, intervehicular leads become so large that it is difficult for drivers to estimate them accurately. Whenever the former situation occurs during a march, drivers operate their vehicles as they would in a close column (unless dispersion is sought, in which event vehicles will not approach closer to other vehicles than a minimum prescribed distance); when the latter occurs, drivers operate their vehicles as they would in an infiltration column until the preceding vehicle slows down sufficiently to permit resumption of reasonably accurate estimates of intervehicular distance. (See par. 122.)

(2) The selection of a specific speedometer multiplier for any particular stretch of roadway will ordinarily require a compromise between two mutually conflicting requirements. In the first place, it is desirable to increase intervehicular leads so as to avoid presenting a concentrated target to enemy attack. It is particularly desirable that vehicles never approach closer to each other on the road than the maximum diameter of the effective burst area of a shell or light bomb. (This diameter will generally not exceed 30 to 50 yards.) In the second place, it is often necessary to reduce intervehicular leads in order to facilitate column control, decrease road time, minimize delay to cross traffic, or increase traffic flow through traffic bottlenecks.

(3) Since intervehicular lead in open column marching varies directly as speed, the stretch of road at which the slowest speed occurs is the one which is critical insofar as dispersion of vehicles in the column is concerned. (Momentary halts or reductions in speed may be disregarded.) Hence, it is necessary to base the selection of a speedometer multiplier on the slowest speed expected between halts. Thus,

$$\text{Speedometer multiplier} = \frac{\text{desired minimum intervehicular lead}}{\text{slowest speed expected between halts}}$$

For example, as a result of careful consideration of the requirements affecting the selection of speedometer multipliers as indicated in (2) above, it is decided that vehicles should not approach closer than 35 yards. The slowest speed expected during the next stage of an open column march is 10 miles per hour. Vehicles average 7 yards in length. The highest speed expected is 30 miles per hour. It is obvious

that if an intervehicular lead of at least 42 yards is maintained at 10 miles per hour, sufficient lead will be provided at all speeds greater than 10 miles per hour. Hence, the speedometer multiplier in this case should be $42/10$ or $4+$. A speedometer multiplier of 5 would be prescribed. At 30 miles per hour intervehicular lead will be 150 yards. (This example is illustrated in fig. 6.) It is often advisable to prescribe a minimum distance beyond which vehicles will not close either at the halt or while the column is in motion. The speedometer multiplier obtained by use of the above formula must not produce an intervehicular headway greater than that required to maintain time length of columns within the prescribed limit.

(4) In order to localize intracolumn interference resulting from inaccurate maintenance of intervehicular headways, it is desirable to have serials and march units move a specified number of minutes behind the head of the column. Vehicles do not close up at the halt, but stop with approximately the same spacing between vehicles as was being maintained just before the halt was executed.

(5) If it becomes necessary or desirable to reduce the time length of a march unit while it is in motion, the march unit commander can indicate a smaller speedometer multiplier. When this is done, the head of the march unit should slow down or stop until the tail of the unit has been able to close up sufficiently to observe the smaller speedometer multiplier. This time should be approximately equal to the desired reduction in time length. When it becomes necessary or desirable to increase the time length, this may be accomplished by indicating a larger speedometer multiplier. Before the time length is increased, the march unit commander should make certain that there is sufficient time-gap between the rear of his unit and the head of the following unit to absorb the increase. The march unit control car should then continue the march at the fastest safe speed, each following vehicle slowing down until it is following the car ahead by the desired distance.

(6) When protective dispersion is not necessary (e. g., during peacetime marches or under conditions of friendly air superiority) a doubled staggered formation may be used. (See fig. 7.)

(7) A traffic escort is required for an open column, except where other traffic on the route of march is light.

d. Advantages.—Open column provides the best possible compromise between the conflicting requirements of a large traffic flow (or short time length of column) and a wide dispersion of vehicles within the column. Intracolumn interference is minimized, and the rate of march is practically as high as in infiltration marching. Column control is not as good as with close column, but it is much superior to that obtainable by infiltration. Driver fatigue and probability of accident is much less pronounced than in close column

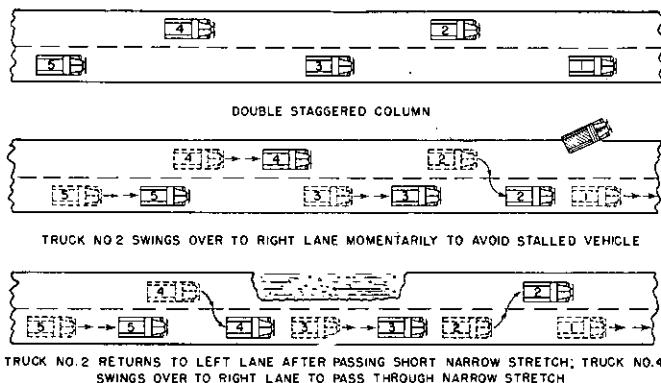

FIGURE 7.—Double staggered column.

marching. Because time interval between vehicles is greater than in close column, it is easier to direct units to alternate routes in an emergency. On dusty roads, open column gives drivers better vision and better control of their vehicles than if close column were used.

e. Disadvantages.—Because of the relative regularity of vehicle spacing, little secrecy is possible in moves of this type during daylight, and more losses will be suffered during aerial and mechanized attacks than will be the case with an infiltration column. Intervehicular headways in an open column are generally longer than in a close column, and consequently the full traffic capacity of the road is not utilized. Other traffic may be delayed, since headways are smaller than in infiltra-

tion marching and may not be sufficient to permit such traffic to pass through the column. Driver fatigue is greater than when infiltration marching is used, and drivers must be trained to estimate and maintain the variable leads required.

■ 59. SHUTTLING.—*a. General.*—When repeated trips of the same vehicles are required in order to transport troops or supplies, a system of movement known as *shuttling* is employed. Any of the foregoing types of march, depending on traffic and tactical conditions, may be used for shuttling. This system is not well suited for the movement of troops to an area in which combat is imminent unless the force moved in the first trip is capable of sustained combat pending arrival of remainder of unit. The dumping of organic cargoes in order to move foot troops by shuttling must be limited to those supplies not immediately needed in combat area.

b. Planning.—The formulas given in paragraph 131 may be used for estimating the time required for shuttling movements. Terminals are selected so as to provide adequate turn-around facilities. The preparation of entrucking and detrucking tables (see par. 127) will help eliminate delay and confusion at terminals; and the march graph (see par. 129) will assist in scheduling the movement.

c. Execution.—There are two general methods by which shuttling may be performed. In the first method, troops or supplies may be transported over the entire distance between the origin and the final destination. This is the normal method of shuttling and the only method applicable to the movement of supplies. It is easy on the troops to be moved, and it eliminates uncertainty in making contact with troops once they start out on the road on foot. Total time required for shuttling by this method is somewhat greater than by other methods, but in most tactical movements time saved by having troops march part of the way on foot is negligible and usually does not justify the complicated planning required. Sometimes it may be desirable to have troops march part of the way on foot. In this case, the truck column on its first trip will stop short of the destination at a previously reconnoitered turn-around. The troops detruck and march the remaining distance on foot. Meanwhile, the troops to be transported on the second trip start off on foot as soon as the truck column clears the original entrucking point with

its first load. The trucks which transported the first load of troops, after turning around, then move back along the line of march or on parallel routes, pick up the second load of troops, and transport them to a second detrucking point nearer to the destination than was the first. The process is continued until the last load is picked up and transported to the final destination. This method of shuttling has the advantage of reducing the total time required for the movement and truck mileage with consequent savings in gas and oil. Its disadvantages are lack of simplicity and greater troop fatigue. This method of shuttling may be varied by having the truck column return all the way to the origin to pick up loads after discharging preceding loads at previously reconnoitered turn-arounds short of the destination; or by having the truck column transport the first load direct from the origin to the destination and on subsequent trips proceed all the way to the destination after picking up troops who have meanwhile proceeded on foot along the route of march.

SECTION III

MARCH TECHNIQUE

■ 60. CONTROL.—*a. March discipline.*—March discipline is indispensable to the control of a march column. The specific objective of march discipline is to insure intelligent cooperation and effective teamwork on the part of march personnel. Such cooperation and teamwork can be attained only through constant and thorough supervision by every officer and non-commissioned officer, adequate training and considerable practical experience in actual marching, and meticulous attention to all of the following details of march technique:

(1) Immediate and effective response to all signals and orders.

(2) Strict obedience to traffic regulations, rules of the road, and instructions of traffic personnel.

(3) Effective use of cover, concealment, camouflage, dispersion, radio silence, blackout precautions, and other protective measures against air, ground, mechanized, or chemical attack.

(4) Prompt relaying of visual signals.

(5) Correct speeds and headways.

(6) Proper care of transport and equipment.

(7) Observance of rules of march hygiene.

b. Intracolumn communication.—As a rule, whatever method of intracolumn communication is used, only brief, simple messages should be transmitted while a column is in motion. Long or complicated messages are best transmitted verbally, or in the form of a written order, while the column is halted. Various methods of intracolumn communication are discussed below:

(1) Two-way voice radio sets located in the control, trail, and commander's cars, supplemented by small receivers in all other vehicles in the column, provide the best intracolumn communication possible and permit maximum flexibility in the control of a motor column.

(2), In the absence of radio facilities, or when radio silence must be enforced, less complete control of the march column can be effected by use of visual and sound signals, and motorcycle messengers and staff cars. Standard hand signals for this purpose are given in paragraph 14. Flag signals are sometimes used, but they are rather complicated and are usually undesirable because of camouflage considerations. Sound signals and pyrotechnics are generally reserved for warning against sudden danger—as an air, mechanized, or chemical attack.

(3) When other means of communication cannot be used, simple messages from the front of the column may be written on a sign board and posted on the right side of the road (or displayed by a guide) so as to be visible to oncoming vehicles. Such messages are then noted by the driver and commander of each vehicle as they pass the sign board. Provision is made to pick up these sign boards (or guides) as the rear of the column passes. Longer messages directed to a specific vehicle in the column may be written on a message blank, given to a guide stationed along the route, and transferred by him to the proper vehicle. For this purpose, use may be made of the railroad expedient of fastening the message to a large wire loop and suspending this loop at the end of a forked stick held or placed 6 to 8 feet high on the right of the column where it can easily be caught on the arm of the front seat passenger while the vehicle continues in motion.

(4) Written or verbal messages may be sent from rear to front by motorcycle messengers, who drive up alongside the vehicle concerned and transmit the message directly to the driver or front seat passenger. In this connection, a proved

expedient is the use of a short stick with a common clothespin at one end. Communication facilities installed along the route of march may also be available for use in the control of a moving column. Aircraft may sometimes be available to pick up a radio or panel message from one part of a long column and transmit it by visual signal or radio while flying directly over another part of the column.

c. Control personnel.—(1) *Column, serial, and march unit commanders.*—Column, serial, and march unit commanders, together with their command echelons, are free to move wherever necessary to insure proper control. It is usually desirable, however, that commanders be near the head of their respective units in order to make prompt decisions as different situations arise. It may sometimes be desirable for the column commander to leave the column and move directly to the march destination. Whatever his location, however, the column commander should habitually keep in close touch with any detached parties sent out to the front, rear, or flanks of the main part of the column.

(2) *Control officers.*—Detailed control of the main column (or element thereof) is usually delegated to the column (serial or march unit) control officer. This is normally the executive officer or second in command. The column control officer's echelon includes that part of the headquarter's staff not elsewhere employed, and representatives from each serial or march unit within the column. Control officers are responsible for leading the column (or element thereof) along the designated route, and for regulating the speed of movement (see par. 55). Time length of column (or element thereof) is regulated in accordance with instructions transmitted by the column (serial or march unit) commander or by traffic personnel of a superior headquarters. The column control officer (by radio or other means of intracolumn communication) should periodically announce the time the head of the column passes specified check points along the route of march. If the column is moving in accordance with a march table or a march graph, the control officer is responsible that the movement schedule indicated therein is strictly adhered to, and particularly that the tail of the column clears points of possible conflict with other columns within allowable time limits. In the event this becomes impossible, both the column commander and traffic control personnel must be notified.

(3) *Trail officers.*—The column (serial or march unit) trail officer marches at the rear of the column (or element thereof). His job requires considerable skill and good judgment, as well as a thorough knowledge of motor transport technique. For this reason, an experienced motor officer or transport officer is usually selected. Trail officers usually perform the following duties:

(a) Dispatch individual vehicles, march units, or serials from the column (serial or march unit) IP.

(b) Report location of tail of column (or element thereof) to their respective control officers when called on to do so.

(c) Inspect disabled vehicles and decide whether to repair them on the spot, abandon them (see par. 66) or take them in tow.

(d) Note infractions of march discipline, and when necessary take immediate corrective action.

(e) Prevent vehicles or other columns from passing from the rear whenever this operation presents a traffic hazard.

(f) When column halts, post necessary guards, warning flags, caution lights, or flares to warn traffic approaching from the rear.

(g) The column trail officer picks up and, as soon as practicable, returns to the head of the column all guides and markers distributed by preceding elements of the column.

(4) *Traffic escort.*—The traffic escort, in addition to other duties (see par. 111) assists the control officer by eliminating or minimizing traffic delays and traffic hazards.

(5) *Assistant drivers.*—Assistant drivers or front seat passengers should be constantly on the alert for column signals and warnings, and for signs placed along the road, transmitting them back along the column when appropriate and warning the driver. This is particularly important at night or under conditions of poor visibility. The assistant driver should constantly assure himself that the driver is awake. At halts, he should assist the driver in inspecting his vehicle.

d. Identification of special vehicles.—To assist in identification for control purposes, message center vehicles of companies and similar units should display guidons. Message centers of battalions, regiments, and similar units may be indicated by distinctive symbols or panels displayed on the front, rear, top, and sides of appropriate vehicles. When

necessary for camouflage or other reasons, guidons may be cased and symbols or panels may be covered or temporarily removed. The trail car in a column may have red cloth attached to the radiator grill and tail gate. The column control car can be indicated by white cloth. Green cloth may be used for serial control cars. Serial trail cars may use yellow cloth. Colored lights of suitable design or special patterns formed with luminous buttons should supplement colored cloth in night operations. Vehicles within a column should be numbered serially to facilitate formation of the column and identification of individual vehicles. Such numbers may be drawn on the sides of vehicle cabs with soft chalk crayons, or indicated by previously prepared cloth, paper, or metal signs. Special markings, such as red flags or painted signs, will be displayed on vehicles transporting explosives or inflammable liquids. To assist drivers in night driving during blackouts, the use of patches of white or luminous paint on the rear of vehicles is indicated.

e. Use of vehicle odometer or mileage indicator.—Points along the route of march can be conveniently referred to in terms of the mileage from the IP (or other specially designated point). The odometer reading of each vehicle on passing this point should, therefore, be noted and recorded by the driver or front seat passenger. Trip odometers, in vehicles so equipped, should be set at zero on passing the IP (or other specially designated point)..

■ 61. ENTRUCKING AND DETRUCKING.—*a. General.*—Entrucking and detrucking are often the critical operations in a motor movement. It is, therefore, essential that detailed plans be made whenever possible to insure that these operations proceed in an expeditious and orderly manner.

b. Organic transportation.—Entrucking in and detrucking from organic transportation should be a part of "Standing operating procedure" in every motorized and mechanized organization.

(1) Entrucking is normally completed while trucks are dispersed in bivouac or assembly areas. Each march unit and serial commander is responsible for the formation of his own unit and for scheduling his movements so as to arrive at and clear serial and column IP's within prescribed time limits and without halting to wait on the road. If danger-

ous congestion, delay, and traffic conflicts are to be avoided, great care must be used in selecting routes to IP's and in scheduling arrival and clearance times thereat. The sequence prescribed for the clearance of march units and serials at the column IP is based primarily on tactical considerations.

(2) Detrucking ordinarily is effected after the march column has deployed in unit assembly or bivouac areas. For reasons of security and avoidance of traffic delays, movement of each vehicle should be continuous and uninterrupted from time of arrival at the regulating point until the final destination is reached. This may be facilitated by posting guides (par. 111) or markers (par. 108) at the regulating point and other appropriate locations within the detrucking area.

(3) Assembly and bivouac areas should be assigned so as to facilitate entrucking for the next movement. Each unit commander, or his representative with the quartering party, posts guides and markers to indicate the exact location of assembly areas of subordinate units. As each vehicle arrives at the entrance to its assembly area, it leaves the route of march and is directed by guides or markers to its position. Detrucking takes place only after each vehicle has been spotted in its designated location. While in assembly or bivouac areas, all units provide their own local security against air and ground forces. This must be continuous from the arrival of the first vehicle until the area is vacated. After assembly or bivouac areas have been occupied, each truck moving therein at night must be preceded by a man on foot in order to avoid running over sleeping personnel. As an additional precaution, the routes used by vehicles should be delineated, and troops should sleep at a safe distance therefrom.

c. Nonorganic transportation.—(1) When nonorganic transportation is involved, entrucking and detrucking becomes a rather complicated operation. Entrucking and detrucking tables (see par. 127) are usually prepared for large or important movements. When entrucking is properly organized and executed, vehicles move past the IP and take their proper places in the convoy without halting. The convoy trail officer is usually stationed at the IP to see that the convoy forms in the prescribed order and is dispatched in accordance with the instructions of the convoy commander and convoy control officer.

(2) Entrucking and detrucking points should be located on the road so as to be as convenient as possible to the troops or supplies to be moved. Main roads should be avoided, if practicable, in order to minimize interference with other traffic. If a choice exists, entrucking and detrucking points should be selected so as to favor loaded vehicles with routes having shorter time distances and more gentle grades. Adequate loading or unloading facilities should be available, particularly when supplies are being moved. In a supply convoy, trucks may be loaded prior to the start of the march; in a troop movement, however, personnel are entrucked just prior to departure, and when practicable, trucks are headed in the proper direction before troops are loaded. Troops should not arrive or be entrucked any sooner than necessary to allow trucks to move off promptly at the prescribed time.

(3) Entrucking or detrucking groups, including any organically motorized groups that are to move as part of the convoy, are numbered serially in the order in which they are scheduled to pass the IP. For purposes of identification, the leading vehicle of each group should have prominently displayed on the lower right hand corner of its windshield the number of its group. The primary consideration in numbering these groups is the order in which the commander desires them to move in the convoy. It is desirable, however, to avoid complicating the interior organization of the motor transport unit by changing the original arrangement of vehicles in the convoy. A reinforced battalion (or equivalent unit) is about the largest organization that can be handled efficiently as an entrucking or detrucking group.

(4) Loading of personnel at entrucking points, including counting off men into vehicle loads and designating trucks to carry them, is carried out under the supervision of troop officers *in a covered position off the road*. It is desirable that each unit be given full details beforehand as to location of its entrucking points and the number and capacity of vehicles allotted to it. In assigning vehicle loads, tactical necessity may outweigh consideration of the comfort of troops as well as the rated weight capacity of vehicles (see FM 101-10 for personnel capacity of standard trucks). When loading must be accomplished under difficult conditions, complete plans must be made to meet the incoming motor transport convoy at a regulating point, divide it into entrucking groups, guide

these groups to entrucking points, route and schedule their movements to the initial point, conduct the convoy to a regulating point at the march destination, break up the convoy into detrucking groups, guide these groups to detrucking points, and route and schedule the movement of detrucking groups to the IP at which the convoy forms for its return trip. These plans must be prepared so as to eliminate traffic conflicts, conserve the energy of troops being moved, and facilitate the prompt return of nonorganic transportation.

■ 62. HALTS.—*a. Duration and frequency.*—During moves of less than 3 hours' duration no halt is necessary except during blackouts or under adverse driving conditions. Halts for large columns are usually prescribed in orders from higher headquarters. For smaller columns where the choice lies with the column commander, a halt of 15 minutes at the end of the first hour should be made. Thereafter, a halt of 10 minutes every 2 hours is advisable. One half hour to 1 hour is usually allowed for mess and refueling halts. During combat both the duration and frequency of halts may have to be reduced to shorten road time and decrease the period of exposure to enemy attack.

b. Selection of halting places.—Halting places are generally selected in advance by the reconnaissance party. During active operations, winding roads and wooded stretches make the best halting places, since they prevent a straight line target for air attack and provide good concealment. If the halt is of only brief duration, the column may stop on the shoulder of the road on which it is traveling. Otherwise, vehicles should be parked in irregular patterns under cover—preferably on the right side of the road. A column should never halt on a traveled lane, on a narrow road, or at any other location where it will interfere with other traffic, if such places can possibly be avoided. It is desirable that halting places provide turn-around facilities so the column may be quickly reversed if necessary. Crossroads, railroad crossings, and similar points are avoided as far as possible, both to prevent interference to cross traffic and to keep the column clear from points likely to attract artillery fire or air bombardment. No part of the column should stop on steep grades or bridges. Comfort of personnel and servicing facilities for vehicles are important considerations in selecting sites for

long halts. During peacetime, when a column starts from a populous area, its first halt should be delayed until the country is reached so as to permit relief of personnel. For the same reason halts should not ordinarily be made in villages or towns unless there is a special need therefor.

c. Procedure at halt.—Columns should be halted at points providing adequate sight distance for approaching traffic. In all cases at least 200 yards of clear view must be maintained to the rear of the last vehicle of the column. When the column halts so as to force traffic proceeding in the same direction to move on the left of the center line of the roadway, 400 yards clear sight distance should be available throughout the entire length of the parked column. If road conditions prevent these sight distances, steps must be taken to forewarn approaching traffic (see par. 60c; also *d* below).

(1) If crossroads, railroad crossings, and similar danger points lie within the halt area of a column, subordinate commanders will require vehicles to stop at least 15 yards or more from the crossing. When halting on the road, vehicles pull off as far to the right as possible. If shoulders are soft, it may be necessary to keep left wheels on the firm-traveled part of the road. When parked at the side of the road, front wheels of all vehicles are cut toward the center of the road so as to facilitate a prompt start at the end of the halt; if parked off the road, vehicles should be headed in direction of probable movement when march is resumed.

(2) It is usually desirable to halt at a specified time, rather than on a hand signal transmitted from the head of the column. Otherwise, the tail of a long column may not receive the order to halt until the head of the column has resumed movement. Halting distances between vehicles depend on the tactical situation and road space available. (See pars. 56c, 57c, and 58c.)

d. Duties at halts.—Drivers or assistant drivers make the inspection required in paragraph 33. Guards, warning flags, caution lights, or flares should be posted in front and rear of the column and at any other points where there is a hazard to passing traffic. Troops remain off the road to the right of their assigned vehicles and must keep the traveled portion of the roadway clear at all times. If the column blocks parts of the road at the halt so that it is necessary to operate two-way traffic in a single lane, authorized traffic

movements should be alternated by using flags transmitted alternately from one end of the single lane road to the other by the last vehicle of each passing traffic group, or pilots to control traffic first in one direction and then in the other (see par. 109). When traffic approaching the halted column (or element thereof) from the rear cannot clear the column prior to its resumption of march, trail officers will require this traffic to remain behind until it is safe for it to pass.

■ 63. REVERSING DIRECTION.—There are three general methods by which a column may reverse direction:

a. *Circling back.*—This is the simplest method of reversing direction. If too long a detour is not involved, a loop road is used. However, a loop road is not essential when a passable circuit of sufficient size is available off the road, or when the road itself is of sufficient width. When traffic must leave the road to circle back it may sometimes be necessary to cut a gap in a fence or fill in a wide ditch. This is often preferable, however, to a long roundabout detour.

b. *Consecutive Y-turns.*—A Y-turn differs from a turn made by circling back in that it is necessary to operate the vehicle in reverse at one stage of a Y-turn. Crossroads, road forks, or even wide points in the road are generally sufficient to accommodate a Y-turn, whereas a much larger area is required for circling back. *The back movement of a Y-turn should be executed to the driver's left, rather than to his right, unless poor footing or some other local feature makes this inadvisable.* (See fig. 8.) When a Y-turn is executed in this manner, vehicles coming out of the turn conflict least with succeeding vehicles in the column. If the backing movement is executed to the right, on the other hand, it is necessary for vehicles leaving the turn to cross the path of vehicles entering the turn. Assistant drivers should always dismount in order to assist their drivers in making a Y-turn. When trail loads are being carried, Y-turns are very difficult and require great skill on the part of drivers and assistant drivers. With trail loads, therefore, it is usually worthwhile to make a considerable detour in order to execute the turn by circling back.

Consecutive Y-turns are Y-turns executed successively from the head of the column, or elements thereof. Vehicles

follow each other round the turn as closely as practicable. When completing the turn, the leading vehicle moves out in the new direction in the same manner as from a halt. Other vehicles follow in turn, taking up their positions in column in accordance with the type of march specified.

c. *Turning simultaneously.*—The quickest way to reverse a column is to have all vehicles turn simultaneously. When this is done, the head of the column becomes the tail and the order of march is reversed. Y-turns will usually be used, although vehicles may circle back simultaneously if there is

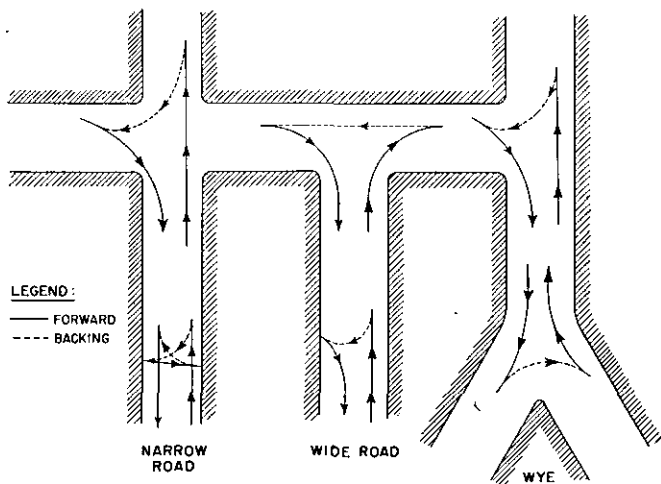

FIGURE 8.—Proper method of executing Y-turn when interfering traffic is blocked off.

sufficient space available. Other traffic should be blocked off at both ends of the column before the signal for reversing direction is given. The movement may be executed more promptly if the order to turn can be transmitted by radio to every vehicle in the column. When only a few vehicles, such as commanders' cars, control cars, trail cars, and similar vehicles are equipped with radio, the order to turn may be transmitted by radio to these vehicles, and relayed by hand signal (see par. 14) or motorcycle messenger to individual

vehicles. When no radio communication is possible, the order to turn is transmitted from the column control car to all vehicles in the column by means of relayed hand signals, or by a motorcycle messenger dispatched by the column commander. On receiving the signal to reverse direction, each driver immediately turns his vehicle around and, as soon as the vehicle ahead has moved out, resumes running speed in the new direction.

■ 64. REFUELING.—*a. General.*—Halts made for other purposes should be used for refueling (and replenishing oil) whenever possible. It is important that refueling be accomplished before there is any possibility of exhaustion of fuel by any vehicle in the column. If done too early, however, the refueling operation will have to be repeated more frequently than necessary. Refueling is usually accomplished immediately at the end of a run; but during tactical operations advantage is taken of every opportunity to keep fuel tanks filled. When a limitation of the supply of fuel available requires that vehicles be partially refueled only, close supervision of fuel distribution is necessary to take care of individual differences in fuel requirements of various vehicles.

b. Fire precautions.—In order to minimize the fire hazard, engines must be cut off, care must be taken to avoid spilling fuel, and there must be no smoking on or near vehicles during the refueling operation. (See sec. V, ch. 5.) When a column is subject to enemy attack, refueling is a particularly hazardous operation. It is therefore highly desirable that refueling during combat be carried out under cover of darkness, or if in daylight, in wooded areas.

c. Methods.—Fuel may be made available to vehicles in a column from—

Filling stations.

Tank trucks equipped with pumps.

Filled containers.

Gasoline dispensing units (QM).

d. Filled containers.—Of the four methods of refueling a column given in c above, the third is by far the most rapid. Whenever it is practicable, therefore, gasoline should be supplied in filled containers. Ordinarily these containers should be issued to each vehicle before the beginning of the march. The next best procedure is to supply fuel in filled containers

which can be distributed down the length of the column from a truck during a halt.

e. Tank trucks equipped with pumps.—Refueling may be accomplished in four ways when tank trucks are used:

(1) Tank trucks may be spotted at intervals along the column. In this case, empty containers are filled from the tank truck and carried by drivers to their respective vehicles.

(2) Tank trucks may be spotted off the road at the heads of serials or march units. When this is done, the vehicles of each such serial or march unit move in turn past the tank trucks and are refueled by pump.

(3) Tank trucks may themselves move along the column and refuel each truck in turn.

(4) When each vehicle carries spare fuel containers completely or partially filled, but there is not enough fuel to complete the march, a considerable saving in refueling time may be effected by arranging for tank trucks to refuel only specified vehicles in the column (say every fourth vehicle). While this is being done the spare fuel in the containers of the specified vehicles is distributed to the other vehicles in proportion to their needs.

f. Filling stations and gasoline dispensing units (QM).—A column may be refueled from a filling station or QM gasoline dispensing units as from *stationary* tank trucks (see c above).

g. Refueling during an infiltration march.—Necessary fuel supplies are spotted at the predetermined location for the halt. Vehicles are then refueled immediately on arrival and dispatched individually as soon as refueling is completed.

■ 65. MAINTENANCE.—*a.* When a column is divided into march units and serials, maintenance vehicles generally march at the rear of their respective organizations. During the march, maintenance activities of personnel assigned to such vehicles are usually confined to minor repairs. Major repairs and disabled vehicles (see par. 66) are handled under the supervision of trail officers.

b. In order to conserve their energy for important maintenance work at the end of the march, mechanics should be directed to sleep and get as much rest as possible while the column is in motion. Further details on march maintenance are given in chapter 7.

■ 66. **DISABLED VEHICLES.**—*a. Removal from roadway.*—Disabled vehicles must be cleared from the traveled portion of the roadway without delay. This is particularly important when traveling through towns or other congested areas. When possible, a disabled vehicle should be pushed off to the side of the road, and the driver should signal successive vehicles to pass. Troops should detruck and remain under cover until the vehicle is able to proceed or until they are picked up by the trail officer. If the vehicle is repaired prior to arrival of the trail officer, it should resume the march at the first opportunity and, when so directed, utilize subsequent halt periods to move up to its former position in the column. A maintenance vehicle at the rear of each march unit should be equipped with towing facilities in order to take care of disabled vehicles which cannot be repaired on the spot. If feasible, the trail officers group should include one or two spare vehicles to pick up personnel or matériel of disabled vehicles.

b. Abandonment.—Decision as to temporary abandonment of vehicles is usually made by the trail officer of the march unit or serial to which the vehicle is assigned. If temporary abandonment is decided on, the trail officer leaves the driver, and if possible a mechanic, to effect necessary repairs. Decision as to permanent abandonment is usually made by the column trail officer. When a vehicle is to be permanently abandoned, a tag is attached to the vehicle showing the unit to which it belongs and the reason for its unserviceability.

■ 67. **MESSING.**—*a. General.*—The messing of personnel on a motor march differs little from that of other troops on the march. On one-day trips or shorter moves, the meal en route is usually a cold lunch, although it is preferable to serve a hot meal whenever circumstances permit. If cold lunches are carried, hot or cold drinks will generally be served from thermos jugs or cans. During a night march, coffee should be available for distribution at the halt. March menus should provide an ample amount of vitamin A, since a deficiency of this vitamin may impair driver vision and thus increase the danger of accidents.

b. Mess supplies.—The supply officer is usually charged with local purchase (see par. 53e) and supply of food during a motor movement. He usually accompanies the quartering

party in order to make advance arrangements for procurement of food and delivery at the proper place.

■ 68. NIGHT MARCHES.—*a. Purpose.*—Night marches are usually made to provide concealment from hostile observation. They may also be made as part of a forced march when sufficient distance cannot be covered by daylight marching alone. In hot weather, night marches may be made to avoid excessive heat.

b. Reconnaissance and route marking.—Advance reconnaissance, preferably by daylight, should be made whenever possible (see sec. III, ch. 4). Traffic personnel and markers (see par. 51) should be posted prior to darkness, if practicable, but in any event well in advance of the column.

c. Driving lights.—Operation at night when driving lights are permitted differs from daylight operation only in the measures that must be taken to overcome the adverse influence of darkness upon ease of control and avoidance of accidents. In general, vigilance of drivers must be increased, and speed must be reduced so that drivers are not required to "overdrive" their lights. Some deception, as well as a relatively high rate of march, can be obtained on dark nights by turning off all driving lights in a column except those of the vehicle at the head of each serial or march unit.

d. Blackout marches.—(1) Night marches under blackout conditions are particularly difficult for motor columns, especially when made on poor roads. Practicable speeds will vary from that possible on good roads on a moonlight night to that of men on foot individually guiding vehicles across a bad stretch of roadway. In order to maintain close contact between various elements of the column, it may be necessary to reduce distance between march units and serials to that between individual vehicles. It is extremely important that marker lights, reflectors, windshields, and especially blackout driving lights be kept scrupulously clean in order to utilize efficiently the small amount of light allowable under blackout conditions. The stoplights of all vehicles not equipped with blackout lights must be disconnected.

(2) Blackout lighting equipment on vehicles greatly facilitates movement under blackout conditions, particularly on dark nights. Visibility characteristics of vehicle blackout lamps are indicated below:

Lamp	Distance visible as four lights	Distance visible as two lights	Distance visible as one light	Maximum height at which visible to air observers
Front marker.....		Up to 20 yards.	20-300 yards...	450 feet.
Rear marker.....	Up to 20 yards.	20-60 yards....	60-300 yards...	450 feet.
Blackout driving.....				5,000 feet.

Because of the possibility that enemy observation posts equipped with telescopes may pick up the blackout lights of vehicles moving near the front, it may be necessary to designate a line beyond which no lights whatsoever will be permitted. Under these conditions, road delineators and illuminated road signs provide effective aids to movement.

e. Special precautions.—On night marches strict march discipline is required to prevent accidents, keep units from becoming lost, and eliminate unauthorized use of lights and matches. Constant effort is necessary to prevent drivers from becoming drowsy. This may be accomplished by relieving drivers every 2 hours, by dismounting and exercising them during halts, and by serving hot coffee. The front seat passenger can help keep the driver awake by making conversation with him and insisting on getting replies. Drivers who do not see well at night must be relieved immediately.

■ 69. UNEXPECTED ROAD BLOCKS.—The reconnaissance party or the traffic escort should discover road or traffic blocks, report them to the column commander, and take necessary action to remove them or to detour the column prior to its arrival at the block. When a suitable detour is not available ahead of the column, the column commander must either take necessary action to clear the road block or direct the column to reverse its direction of march (see par. 63).

■ 70. ACCIDENTS.—*a. In war.*—During active combat, or under other wartime conditions where a traffic accident is a minor consideration, the main part of the march column does not

stop to render assistance. If the accident blocks the route, however, the occupants of vehicles in rear must clear the way at once, and then proceed with the march. Necessary steps to care for the injured and salvage vehicles and cargoes are carried out under direction of the trail officer, assisted by medical, maintenance, and salvage personnel.

b. In peace.—(1) *Care for injured.*—When an accident in peacetime results in injury to personnel, the injured should be given first-aid treatment, rendered every other possible assistance, and taken to a hospital if necessary. Injured civilians should be taken to the nearest hospital, civilian or military. In case of injury to military personnel when no medical officer is with the column, the injured person, or persons, usually should be taken to the nearest military hospital. In cases of severe injury, he may be taken to the nearest civilian hospital (see AR 40-505) for emergency treatment. In the latter event, the next higher superior must be notified immediately, giving full details.

(2) *Notify column commander or designated staff officer.*—Peacetime accidents, however trivial, which result in injury to an individual or damage to property, are reported to the column commander or designated staff officer without delay.

(3) *Restore normal traffic movements.*—This is usually taken care of by traffic personnel. It is desirable that damaged vehicles be left undisturbed insofar as practicable, in order to assist the investigating officer in determining how the accident occurred. Safeguards against further accidents should be provided by posting guards to warn approaching traffic and to prevent unsafe parking of vehicles in the vicinity of the accident. Witnesses should remain at the scene of the accident to provide information for the investigating officer. The remainder of the column resumes the march without further delay. Other traffic is kept moving, if possible, and not allowed to congregate around the scene of the accident.

(4) *Conduct of investigation.*—(a) Detailed investigation of accidents involving vehicles of a march column are usually conducted by the trail officer or by some other officer specifically designated by the column commander as the investigating officer.

(b) Pending arrival of the investigating officer, the senior officer or enlisted man at the scene of an accident takes neces-

sary steps to preserve evidence, assembles witnesses, and records their names, addresses, and driver and car license numbers. Drivers of vehicles involved in the accident obtain information necessary for filling in their driver's accident report (Standard Form No. 26). All military witnesses should make note of facts regarding injuries to persons and damage to property, so that full information can be given to the commanding officer charged with appointing a board of officers to investigate the accident or injuries.

(c) The accident investigating officer proceeds to the scene of the accident at once. He sees that the medical officer takes care of any injured, and after giving orders for disposition of dead or injured, questions witnesses, obtains or checks their names and addresses, and when possible takes their sworn statements. Photographs should be taken to provide evidence for possible future use. The investigating officer's report is submitted on Standard Form No. 27. (See AR 850-15.)

■ 71. COLD WEATHER MARCHING.—*a.* Conditions of ice, snow, and extreme cold modify the usual effect of terrain features on motor marches and present special problems. Lakes, rivers, and swamps, when frozen, may cease to be obstacles to motor movement (see par. 134 for carrying capacity of ice). Mobility of motor vehicles is dependent on ice conditions and depth of snow. Possible effects of sudden changes in temperatures, such as thaws and freezes, must be considered. Charcoal, gasoline, or oil stoves in the body of the truck, and specially designed tarpaulins are necessary to insure the comfort of troops being transported. When such expedients are used, due precautions must be taken to eliminate the hazards of fire and carbon monoxide poisoning. Tires should be freed from ice and engines warmed up to a temperature of at least 140° F., before beginning a march in cold weather.

b. Under conditions of thawing and freezing, vehicles heavily encrusted with mud (particularly track-laying vehicles) should have such mud removed from working parts while still unfrozen. Vehicles should not be parked on soft ground or in pools of water or slush when freezing may be expected. Planks, logs, or brush may be used to provide dry standing under such conditions.

SECTION IV

ORDERS

■ **72. WARNING ORDERS.**—Warning orders are of great value in alerting troops and preparing them for a march prior to receipt of the detailed march order. A warning order should be issued orally, or in the case of a large unit, in writing, as soon as information of a contemplated move is received. The following is an example of a warning order for a march:

910th Field Artillery
Fort Meade, Md.,
7 April 19—, 7:45 AM

To: (Staff and command distribution).

1. This regiment marches 8 April (tomorrow) after 7:00 AM, to join the THIRD ARMY southeast of WAYNESBORO.

2. Pass privileges are suspended at once.

3. Details later.

By order of Colonel A:

X
Lt. Col., 910th FA
Executive.

OFFICIAL:

Y

Capt., 910th FA

S-3

■ **73. RECONNAISSANCE.**—If practicable, a road or aerial reconnaissance of the route of march should be made prior to the issuance of the march order. In the continental United States, detailed information for the march may be obtained from the various civilian "Highway Traffic Advisory Committees to the War Department" (see par. 132). Technique of reconnaissance for motor movements is covered in section III, chapter 4. (See ch. 5 for tactical reconnaissance.)

■ **74. MARCH PLANS.**—Every motor movement must be carefully planned as to its own operation, and coordinated with other movements so as to prevent dangerous traffic conflicts. When there is any possibility of producing serious conflicts with other traffic, organization commanders should obtain authority for a march made on their own initiative and give advance notice of time of movement and routes used. Logistical data needed for planning a motor march are given in section VII, chapter 4.

■ **75. MARCH ORDERS.**—*a. General.*—The march order should be issued in sufficient time to allow subordinates to make their

plans, issue their orders, and complete their preparations for the march. The amount of detail given in march orders will depend on the tactical and traffic situation, the state of training of the command, and the degree of adherence to a standing operating procedure.

b. *Form.*—Brief fragmentary orders may be used for simple motor movements. A detailed march order is issued in the form of a 5-paragraph field order accompanied by appropriate annexes. Annexes to the march order may include one or more of the following:

(1) *Administrative order.*—When administrative details are too voluminous for convenient inclusion in paragraph 4 of the march order, it is customary to issue an administrative order as an annex thereto. Any of the following information may be included in the administrative order:

(a) *Supply.*—Methods of supplying food, water, fuel, ammunition, vehicle parts, etc. Special instructions with reference to local purchase of supplies and services.

(b) *Evacuation.*—Details with reference to evacuation of march casualties, burial, salvage of disabled vehicles and their cargoes, disposition of captured material, and handling of prisoners of war. Special instructions with reference to use of civilian hospitals for military casualties.

(c) *Traffic.*—Necessary general instructions as to relief of drivers, doubling, blackout restrictions, marking of vehicles, marking of routes, maximum speeds, obedience to local traffic regulations, etc.

(d) *Personnel.*—Uniform to be worn and equipment to be carried by personnel, method of handling mail, instructions to quartering and clean-up parties, details as to camp site routine, hygiene and sanitation, etc.

(e) *Maintenance.*—Instructions relative to vehicle maintenance, and special types of repairs authorized or prohibited.

(f) *Miscellaneous.*—Any necessary administrative instructions not otherwise covered.

(2) *March table.*—See paragraph 130.

(3) *Strip map.*—See paragraph 114.

(4) *Entrucking and detrucking tables.*—See paragraph 127.

c. *March graph.*—A march graph provides the simplest means of determining the detailed time schedule of a march. (See par. 130 for examples of march graphs.)

d. Example of march order.—See also FM 101-5.

910th Field Artillery
Fort Meade, Md.,
7 April 19--, 1:00 PM

FO 93

Map: Strip map (Annex No. 1).

1. *a.* No change in enemy situation.

b. The **THIRD ARMY** is concentrating in the **CUMBERLAND VALLEY**.

2. a. This regiment will join the **THIRD ARMY** by marching to a concealed bivouac area immediately southeast of **WAYNESBORO**, starting after 8:00 AM, 8 April.

b. Route: See strip map (Annex No. 1).

c. Troops (in order of march):

(1) Reconnaissance, pioneer, and quartering party:

Captain C, commanding.

Lieutenant B with 4 men and 2 reconnaissance cars from Headquarters Battery.

Lieutenant D, one man from each battery, and one truck from 2d Battalion Headquarters Battery.

Lieutenant E with 12 men and 2 trucks (loaded with pioneer tools and bridge timber) from 1st Battalion Headquarters Battery.

(2) Traffic escort:

Lieutenant F, 3 NCOs, 30 privates, and 7 vehicles from Headquarters Battery.

(3) First serial:

Headquarters and Headquarters Battery (less detachments).
First Battalion (less detachments).

(4) Second serial:

Second Battalion (less detachments).

Medical Detachment.

Regimental Supply and Maintenance Platoon (less detachment).

(5) Clean-up party:

Lieutenant G, 6 men, and 1 truck, all from Regimental Supply and Maintenance Platoon.

3. *a.* Reconnaissance, pioneer, and quartering party will leave by 4:00 PM (today) 7 April.

b. Traffic escort will move out at 7:00 AM (tomorrow) 8 April.

c. Conduct of the march:

(1) See march table (Annex No. 2).

(2) Between **EMMITSBURG** AND **ROUZERVILLE** blackout lights will be used. Beyond **ROUZERVILLE** no lights whatsoever will be permitted.

4. See Adm O 37 (Annex No. 3).

5. *a.* The control car of the second serial will relay radio messages when necessary between the column control car and the column trail car.

b. (1) Three long blasts of whistle, horn, or klaxon, repeated several times, will be the warning signal for an air or mechanized attack.

(2) A series of short horn blasts given by any control car will signal the "all clear."

c. Messages to the column control car.

By order of Colonel A:

X
Lt. Col., 910th FA
Executive.

OFFICIAL:

Y

Capt., 910th FA

S-3

Annexes:

No. 1—Strip map

No. 2—March table

No. 3—Administrative order #37

Distribution: A

2 copies to **THIRD ARMY**

NOTE.—The order as given above is more complete than is necessary when a well-developed "Standing operating procedure" is in use.

CHAPTER 4

TRAFFIC MANAGEMENT

	Paragraphs
SECTION I. General.....	76-82
II. Elements of traffic management.....	83-85
III. Reconnaissance.....	86-96
IV. The traffic plan.....	97-104
V. Execution of traffic plan.....	105-113
VI. Traffic aids.....	114-117
VII. Logistical data.....	118-134

SECTION I

GENERAL

■ 76. SCOPE.—Military traffic management consists primarily of coordinating and controlling movements of vehicles, animals, foot troops, and civilian refugees over roadways and within traffic terminals in conformity with the tactical situation and military needs.

■ 77. DEFINITIONS.—For definitions of special terms used in traffic management and motor marching, see paragraph 51.

■ 78. OBJECTIVE.—The objective of military traffic management is indicated in FM 100-10, which reads in part as follows:

“Traffic circulation and control should be such as to obtain the best possible use of the road net within a theater of operations to the end that mobility of the troops may be maintained and that supplies may always be available as and where needed.”

■ 79. CHARACTERISTICS OF MILITARY TRAFFIC.—*a. Mass movements.*—Military traffic management is principally concerned with movements of groups of vehicles having a common mission, rather than with random movements of individual vehicles having limitless variations in origin and destination, such as is the case with civilian traffic.

b. Sudden changes.—Traffic flow under military conditions is subject to large, erratic, and oftentimes unpredictable changes; and flow may be entirely interrupted for short or long periods of time. Since such changes and interruptions may occur

with little or no advance warning, it is essential that information of these changes be immediately transmitted to a central agency having all necessary means and authority to initiate proper corrective measures in time to prevent dangerous congestion. This agency operates under supervision of G-4 of the headquarters which controls the area involved.

c. Passive protection.—Passive protection, obtained by camouflage, concealment, and dispersion of vehicles, is of paramount importance.

d. Discipline and training.—Because all military agencies concerned are subject to centralized control, special traffic measures may be adopted that could not be utilized in civilian practice. Proper driver training, march training, and march discipline greatly assist in the execution of the traffic plan and lessen the amount of detailed control otherwise necessary.

■ 80. COORDINATION.—*a.* Traffic management must also provide effective correlation of all available motor equipment and road facilities with the different types of traffic to be moved. These in turn must be coordinated with announced plans of higher headquarters and needs and desires of adjacent units.

b. When civilian traffic is an important consideration or when movement must proceed over roads under jurisdiction of civilian authorities, advance notice should be given to appropriate civilian agencies so that military traffic can be coordinated with civilian traffic. (See par. 132, with reference to appropriate agency and manner of contact.)

■ 81. MILITARY AGENCIES INVOLVED.—Traffic management requires definite fixing of responsibility in a single central authority operating under supervision of the headquarters controlling the area involved, and close cooperation of all agencies involved. The traffic functions of military agencies involved in traffic management are indicated in FM 29-5, 100-5, 100-10, and 101-5.

■ 82. CIVILIAN EVACUATION.—*a. General.*—Uncontrolled civilian evacuation and refugee movements may result in large volumes of heterogeneous traffic, provide concentrated targets for enemy air attack, and delay or seriously immobilize vital military operations. Such movements are a special form of civilian traffic and require particular consideration in the planning and execution of military operations. Control of

this type of civilian movement is unusually difficult because of uncertainty as to volume, type, and timing of traffic to be expected, and because of the state of panic that may exist.

b. Interference of refugee movements with military traffic in the theater of operations must be avoided or minimized by requiring—

(1) That evacuation take place prior to or during a lull in military movements.

(2) That refugees use roads or trails which carry little or no military traffic.

(3) That refugee traffic be diverted from areas most important for military operations.

(4) That refugee traffic be organized as march columns, whose movements are directed so as to cause least interference with essential military traffic.

SECTION II

ELEMENTS OF TRAFFIC MANAGEMENT

■ 83. GENERAL.—As indicated in paragraph 76, traffic movement emanates from a system of roads, vehicles, drivers, and foot and animal units. All factors must be managed so as to promote expeditious traffic movement and minimize traffic congestion and accidents.

■ 84. TRAFFIC CAPACITY.—The traffic capacity of a route or system of highways can be defined as the maximum traffic volume which can be accommodated in vehicles per unit of time. It is dependent on allowable speed, available lanes, and permissible density (vehicles per unit of distance). Allowable speed will depend on road conditions and the tactical situation. Permissible density will depend upon the limitations imposed by requirements for dispersion as passive protection against air attack or artillery fire. The capacity of various sections of a road will vary—the section of least capacity limits the volume of traffic. Having been assigned a route by higher authority, the column or march unit commander must exercise diligence to insure that the road is used to the fullest capacity consistent with the tactical situation.

■ 85. CONTROL OF TRAFFIC CONFLICTS.—a. All traffic accidents arise from the same basic cause, *which is the conflict of*

moving traffic units with each other or with fixed objects in or adjacent to the normally traveled roadway. Conflicts which the column or march unit commander must consider are of four types—

(1) Between vehicles on intersecting courses.

(2) Between vehicles meeting head-on.

(3) Between vehicles moving along a road and other vehicles, persons, or objects at the edge of or immediately adjacent to the road.

(4) Between vehicles proceeding at different speeds in the same direction.

b. These conflicts, producing either collisions or congestion are due to many factors, including deficiencies of roads, vehicles, and drivers. The last two mentioned are the most important from the viewpoint of the column or march unit commander. Through ignorance, lack of skill, physical incapacity, carelessness or recklessness, drivers aggravate the potential hazards and bottlenecks. This problem can only be solved by proper training and march discipline (see par. 15). Lamps, brakes, identification markers, horns, windshield wipers, mirrors, warning flares, tools, and all other equipment important to traffic safety must be kept in good working condition at all times. Excessive loading should be avoided and overhanging loads should be properly marked at all times. Except in emergencies, no driver should be required to drive more than a maximum of 10 to 12 hours in one day, and he should be given ample opportunity for rest.

SECTION III

RECONNAISSANCE

■ 86. GENERAL.—Traffic reconnaissance is necessary to obtain field information needed for traffic management. Since information must be the most recent obtainable, the type of information and amount of detail will depend primarily on available time, trained personnel, equipment, and on the tactical situation.

■ 87. TRAFFIC RECONNAISSANCE PERSONNEL.—Traffic reconnaissance personnel include all persons who obtain field information for use in planning, facilitating, and regulating traffic movements. Their specific duties and procedures are indi-

ated in subsequent paragraphs. In some cases a traffic reconnaissance party may be accompanied by an engineer or pioneer party (sec. I, ch. 6), a quartering party, (par. 53), and route marking details (par. 108). In other cases the traffic reconnaissance party may be charged with performing these functions in addition to their reconnaissance duties. In forward areas reconnaissance parties should, where possible, accompany security detachments for their own protection. If reconnaissance personnel must operate alone, they should be furnished armored vehicles or at least equipped strongly with offensive and defensive means. In small units, both technical and tactical, reconnaissance missions may be assigned to a single reconnaissance party.

■ 88. INFORMATION REGARDING SPECIFIC ROUTES.—In reconnaissance of specific routes, the following information may be required:

a. Road information.—(1) Location of route (some form of road map must be made if one is not already available).

(2) Location and character of road blocks.

(3) Time distance between various points marking off distinct sections of the roadway.

(4) Number of traffic lanes available in each section.

(5) Types of surface and condition of roadway (including shoulders).

(6) Limiting features (clearance widths and heights, and maximum allowable loads) of structures such as bridges, culverts and overpasses.

(7) Location and characteristics of routes that provide maximum protection from hostile mechanized or air attacks.

(8) Location and characteristics of mines, contaminated areas, and potential traffic bottlenecks.

(9) Maximum gradients and lengths of steep hills.

(10) Location and characteristics of turn-around facilities.

(11) Location and characteristics of by-pass routes or detours around congested areas, fords, bottlenecks, possible ambush sites, and road blocks.

(12) Road construction proposed, required, and in progress.

(13) An estimate of engineer work needed and probable equipment and time necessary for its completion.

(14) An estimate of personnel and material required for decontamination of gassed roads or other special tasks.

b. Terminal and halt information.—Suitable sites for, and pertinent characteristics of halts, turn-arounds, bivouac and assembly areas, entrucking or detrucking points, regulating points, initial points, and other terminal facilities.

c. Supply information.—(1) Facilities for procurement of fuel, repair parts, rations, water, and other supplies.

(2) Repair and replacement facilities for vehicles and armament.

(3) Evacuation and hospital facilities.

(4) Toll charges, if any, on the route.

d. Traffic movements.—The probable volume of traffic that may be encountered along the route, any significant time variations in existing traffic flow, and any traffic blocks that might be expected.

e. Control measures.—(1) Location and type of traffic aids including signs, road delineators or other markers, and traffic signal devices.

(2) Markers, signals, guides, or guards that may be needed at specific locations.

(3) Determination of practicable speeds through potential traffic bottlenecks and around sharp curves.

f. Other agencies.—When movements are to be made over routes under the jurisdiction of other units or under civilian control, contact with these agencies should be made well in advance in order to obtain full information regarding possible routes, time when they may be used to best advantage, and local assistance that may be expected. (See par. 132.)

■ 89. SOURCES OF INFORMATION.—*a. Maps and aerial photographs.*—Preliminary information as to the location of roads, their general alinement, and other characteristics may be obtained from a study of maps or aerial photographs, from consultation with the engineer officer of the pertinent service area, and from civilian traffic authorities. (See par. 132.)

b. Field reconnaissance.—Even though other sources of information may be available, actual field reconnaissance is usually necessary to supplement data already obtained, to substantiate this information, and to bring it up to date.

■ 90. RECONNAISSANCE EQUIPMENT.—Equipment needed for reconnaissance will vary with type of information sought. In addition to general equipment carried by a reconnaissance party in the field, traffic reconnoissances should give special attention to the following requirements:

a. Transportation.—Sufficient light vehicles, preferably with good cross-country performance, are a necessity. When contact with the enemy is probable, armored vehicles affording protection to personnel should be used. Aircraft may be needed for hasty road reconnaissance and for locating impending traffic jams.

b. Communication.—Communication facilities in the form of radio and motorcycles are desirable. Panels should also be carried when aircraft are being used in traffic work.

c. Maps and aerial photographs.—Maps, particularly road maps, are needed for orientation and guidance and provide a convenient form on which to record road data. Recent aerial photographs provide a valuable supplement to maps, particularly when old maps must be used.

d. Special equipment.—The following equipment will be found useful:

- (1) Recording speedometer.
- (2) Compass.
- (3) Tapes or calibrated rods for bridge, culvert, ford, and overpass measurements.
- (4) Engineer sketching equipment.
- (5) Camera.
- (6) Means for erecting signs and for testing soundness of bridge timbers.

■ 91. INSTRUCTIONS TO PERSONNEL.—*a.* Directives for reconnaissance cover the following points:

(1) The mission of the reconnaissance party, including routes or area to be reconnoitered, the exact extent and nature of information to be obtained, and form of report desired.

(2) Brief statement of tactical situation.

(3) Maximum loads expected, maximum over-all lengths, widths, and heights of vehicles when loaded, and minimum turning requirements.

(4) Personnel, transport, and equipment available for the work.

(5) Place and time report will be submitted.

b. Upon receipt of a reconnaissance directive, the commander of the reconnaissance party issues a warning order to members of the party, studies information available at the headquarters issuing the directive, makes a map and aerial photograph study of possible routes, and plans his reconnaissance. In deciding how much information to obtain, the reconnaissance commander must be guided by his mission and is, of necessity, limited by the time available. Detailed procedures for obtaining specific types of information together with recording forms are indicated in FM 5-5 and 5-35.

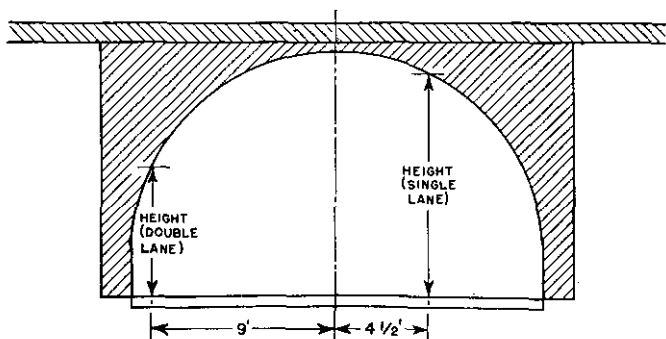

FIGURE 9.—Standard method of measuring vertical clearances under arches.

■ 92. TRAFFIC OBSTRUCTION.—*a. Passability.*—If the route is blocked or is otherwise impassable, a detour around the obstruction should be reconnoitered and marked. If the route can be made passable by limited amounts of work, and time is available, a rough estimate of time and amount of work needed should be made. Otherwise, a record should be made of the nature and extent of the obstructions.

b. Limiting widths.—Whenever movement may be restricted because of narrow widths of roadways or structures (such as bridges and tunnels), limiting widths should be obtained. (See par. 115.)

c. Limiting heights.—Wherever an obstruction over a roadway is low enough to interfere with traffic movements, the

clearance height should be obtained. A suggested manner of obtaining clearance heights is shown in figure 9.

d. Fords.—Fords are inspected for passability, particularly with reference to depth (see par. 133), possible variation in depth due to tides or flood, condition of bottom and approaches, and strengths of current. The exact route through the ford is carefully marked.

e. Ice and snow.—Depths (see pars. 119 and 134) and condition of ice crossings should be determined, as well as the depth and condition of snow over roadways. If dirt, sand, or cinders will be necessary to provide better traction, availability of these materials should be noted, giving locations and amounts.

■ 93. TYPE AND CONDITION OF ROADWAY, AND NUMBER OF TRAFFIC LANES.—Methods of classifying roadways and indicating the number of traffic lanes are indicated in paragraph 115.

■ 94. BRIDGES.—*a. General.*—Bridges should be carefully checked whenever there is any question of their condition, load capacity, or clearances afforded to traffic. If necessary, a detour must be found or the bridge strengthened.

b. Allowable loads on bridges.—(1) In general, newer bridges on the following named roads will carry gross loads as indicated:

Strategic highways of the United States as indicated on War Department strategic map dated September 15, 1939.....	15 tons.
National and State highways.....	15 tons.
Country roads.....	10 tons.

(2) Older bridges will vary and no assumption should be made of their load capacity unless same is indicated on the bridge or otherwise posted. For new bridges with heavy concrete or other type floors giving wide load distribution, single vehicles moving over the center of the bridge at steady speeds of 5 miles per hour or less may exceed the posted loading by 50 percent on one-lane bridges, and by 100 percent on multiple-lane bridges. For old bridges under same conditions, the posted capacity should not be exceeded by more than 25 percent. In case of doubt, the more detailed check methods are indicated in FM 5-35. However, when exact computations are desirable, engineer personnel should be consulted.

■ 95. CONGESTED AREAS.—Congested areas present special problems to reconnaissance parties, primarily because of possible conflict with other military movements or with civilian traffic. If these conflicts are to be minimized, special information will be needed so that necessary correlations can be made. Such information may include the following:

a. Local regulations.—Copies of pertinent local regulations may be obtained.

b. Route or routes.—As far as possible, the more congested sections should be by-passed. If impracticable to by-pass the area, it may be possible to use two or more routes simultaneously in order to reduce time required for passage.

c. Timing of movements.—When practicable, arrival at large cities should be so timed as to permit passage at a time when volume of local traffic movements is at a minimum. Hence, recommendations of local authorities should be obtained regarding best time for making proposed movements.

d. Recommended type of march.—The type of march used will determine time length and road time of a column in passing through a congested area and will govern the extent to which cross traffic will be delayed. Hence, recommendations should be made as to type of march, time length of column, headway between vehicles, and time gap between march units and serials.

e. Speed.—Local regulations will normally govern speeds of casual individual vehicles. However, for column movements with an escort, different speed limits may be desirable. The reconnaissance party should, therefore, obtain information regarding all locations where speed must be decreased or may be increased, and the speeds applicable thereto.

f. Time distance.—The time distance between points of entry into and exit from the congested area may be needed for planning of movements through the area.

g. Camp sites or billets.—If the command is to be halted within the area, the reconnaissance party may be required to locate suitable camp sites or billets.

h. Supply information.—Information regarding supplies may be obtained; or actual arrangements to obtain supplies may be made, if the reconnaissance party has been charged with this duty.

i. Traffic control.—Local authorities will usually lend will-

ing cooperation and may furnish escorts to guide and protect column movements. Consequently, the nature and amount of this assistance should be determined, and an estimate made of additional traffic control personnel and equipment needed to insure efficient handling of traffic movements through the area. (See par. 132.)

■ 96. **REPORTS.**—The report containing the information required by the reconnaissance directive, along with any other pertinent data obtained, is delivered in the form, and at the time and place specified by the directive. A suitable report in most instances can be prepared by marking the route or routes on a road map or an aerial photograph with colored pencils, and indicating thereon the information which has been obtained by means of conventional symbols (see par. 115) and by including photographs and sketches.

SECTION IV

THE TRAFFIC PLAN

■ 97. **GENERAL.**—Although the commanding officer of a column or march unit is not directly involved in traffic planning as such, it is essential that he have general knowledge of the factors involved in such planning by higher headquarters.

■ 98. **INFORMATION NEEDED FOR PLAN.**—*a. Plans of other headquarters.*—Plans of higher headquarters, and all traffic restrictions and priorities imposed by them, and plans of adjacent units, or units using the same route successively, must be considered.

b. Traffic origin and destination.—A general conception of origin and destination of military traffic should be obtained through a map study of the location and lay-out of terminal areas, together with more detailed information obtained from agencies directly responsible for movement of troops and supplies.

c. Priorities, volume, and type of traffic.—Traffic priorities and information regarding volume of military traffic and its composition (foot troops, animals, artillery, tanks, trucks, passenger vehicles, motorcycles, ponton trailers, etc.) should be available from appropriate staff agencies.

d. Tactical and protective limitations.—All restrictions or

precautions pertaining to time, type, spacing routing, or active defense of traffic movements must be determined.

e. Road data.—It is necessary to have information of all available roadways, their relationship to each other, and their traffic characteristics. Types of road data that may be needed are listed in paragraph 88.

f. Civilian traffic.—During peacetime, military traffic must be superimposed on normal civilian traffic flow and coordination with civilian traffic authorities is frequently necessary. During active operations, military traffic personnel must make provision for military control of civilian traffic. (See pars. 82 and 132.)

■ 99. **TRAFFIC PLANNING.**—The preparation of traffic plans is the responsibility of the G-4 division of the staff of a division, corps or army, which coordinates the needs and plans of the various staff sections, arms and services. Road reconnaissance, recommendations to G-4, sign posting, and sometimes aid in execution, are engineer jobs. Execution of the plan—the actual regulation of traffic—is assigned to the military police, under the direction of the provost marshal. Because traffic control serves primarily to further troop movements, supply and evacuation, it must be closely coordinated with tactical plans. The basic attributes of a good plan are simplicity and flexibility.

■ 100. **SYSTEMS OF CONTROL.**—Execution of the plan may be controlled by the *organizational* or *area* systems (see par. 106). The system to be used is a part of the traffic plan.

■ 101. **TRAFFIC SCHEDULES.**—Traffic schedules impose severe restrictions on movement and are used only when a *time* apportionment of roads is necessary because of bottlenecks and priorities. The following types of schedules may be used:

a. Infiltration schedules.—This type of schedule prescribes for each unit concerned, the maximum number of vehicles that may be dispatched from the origin over a designated route during any 1 hour.

b. Column schedules.—Such schedules are usually given in the form of march graphs, march tables, or march control tables (see par. 129).

c. Location, route, and system schedules.—These schedules are necessary to coordinate column schedules at important

traffic bottlenecks and at locations where an intersection or junction of movements occurs.

■ 102. CLASSIFICATION OF ROUTES.—*a. General.*—Routes may be classified according to degree of control exercised by the traffic authority. Actual control employed at any time will be the minimum required to obtain desired results.

b. Open.—An open route is a roadway over which a central traffic authority normally exercises only a minimum of supervision. Ordinarily, supervision on an open route is limited to control of traffic at intersections with a dispatch or a supervised route, and to the posting of necessary traffic signs and regulations. Traffic control personnel needed on an open route are usually furnished by march columns using the route. Control exercised by central traffic authority on an open route is analogous to civilian control over local farm roads carrying a small traffic flow.

c. Supervised.—A supervised route is a roadway over which limited control (by means of traffic posts, traffic patrols, or both) is exercised by a central traffic authority. Small units are ordinarily allowed to use a supervised route without prior correlation of individual march schedules, but time of access to the route may be regulated at control posts in conformity with the traffic situation. Control on a supervised route is somewhat analogous to the civilian control normally exercised over primary highways.

d. Dispatch.—A dispatch route is a roadway over which full control, both as to priorities of use and the regulated movement of traffic in time and space, is exercised by a central traffic authority. Dispatch routes are controlled by the schedule system (see par. 101). The operation of a dispatch route is analogous to that of a railroad.

e. Reserved.—A reserved route is one that is set aside for the exclusive use of a designated unit or specified type of traffic, or for other specific purposes.

■ 103. NIGHT OPERATIONS.—The primary reason for night movements is to obtain secrecy and concealment. They may be desirable also to obtain maximum traffic flow over a route by utilizing it 24 hours each day, or to cover greater distances by lengthening the duration of marches. The fundamental considerations affecting the planning of night movements are reduced visibility and maneuverability, highly

variable rates of march and greater time distances, reduced capacity of roadways, the possible need of one-way routing, increased difficulty of communication, and greater need of special traffic aids.

■ 104. TRAFFIC ORDERS.—The completed traffic plan culminates in the traffic order, issued by the headquarters responsible for traffic control, as a paragraph of the administrative order. The traffic order should contain all information and regulations necessary for guidance of units using the road net. Standing traffic orders and regulations need not be repeated. If time permits and the situation requires it, any or all of the following information may be included in the traffic order:

a. *Time effective.*—Whenever any provisions of the traffic order extend over a period of time different from that of other paragraphs of the administrative order, the time applicable in each instance should be stated.

b. *Location of terminals.*—Locations of supply, evacuation, administrative establishments, and other traffic terminals are usually stated elsewhere in the administrative order. However, information as to the location of all important traffic terminals is essential to the execution of the traffic order and should be indicated on the circulation map, if one is issued.

c. *Routes.*—Direction of movement on each important roadway, number of traffic lanes, type and condition of surface, weight and clearance limitations of structures or other limiting features, average time distance during daylight between terminals and junctions, and control classification of each route should be indicated whenever practicable. This information is usually shown on the circulation map.

d. *Time and space restrictions.*—If the use of a roadway is restricted by schedules (see par. 101), or if a roadway is reserved for the exclusive use of a designated unit or for other purposes during any period of time, such information should be stated in the traffic paragraph, shown on the circulation map, or indicated in a time schedule annex to the administrative order. If no vehicles, or only specially designated vehicles, are allowed to proceed beyond a specified point during hours of daylight or hours of darkness, such restrictions should be indicated on the circulation map.

e. Priorities.—Traffic priorities may be indicated by schedules or by time and space reservations. However, if no schedules exist, or if it is not practical to make time or space reservations, priorities should be stated in the main part of the traffic order.

f. Restrictions on type of traffic.—Whenever any type of traffic (such as foot troops, animal columns, or empty vehicles) is restricted from using, or is required to use, specified routes, these limitations should be clearly indicated.

g. Protective measures.—Measures pertaining to security or passive protection of traffic movements, such as limitations on traffic, special routing or scheduling, or blackout operation, may also be prescribed in the traffic order.

h. Traffic communications.—Unless indicated elsewhere or already in effect, all general information pertaining to the location of traffic headquarters or other traffic establishments and to communication regulations affecting them should be stated.

i. Construction.—Functional specification of road and bridge work required and the priorities of such work should likewise be indicated in the traffic order.

SECTION V

EXECUTION OF TRAFFIC PLAN

■ 105. GENERAL.—This section is primarily devoted to techniques applicable to execution of the traffic plan by traffic control personnel. The commanders of small units should have detailed knowledge of the various control systems used in order to insure intelligent cooperation with traffic control personnel.

■ 106. SYSTEMS OF CONTROL AND TECHNIQUES.—*a. Systems.*—There are two general systems of control; their use in a particular situation depends upon the number of routes available, the traffic conditions, and tactical considerations.

(1) *Organizational control.*—Under organizational control, traffic personnel from the organization on the march exercises control, usually by means of an escort. The escort regulates traffic only along the route traveled by the column and only insofar as necessary to assure its free movement with a minimum interruption of other traffic. This type of control is chiefly used in movements of individual units when

conflict with civilian or less important military traffic is all that is anticipated.

(2) *Area control*.—Under area control, the headquarters responsible for traffic control in the area assigns traffic personnel to *point*, *escort*, and *patrol duty* in order to regulate all traffic in accordance with the circulation plan in effect. Area control is used chiefly when large scale traffic operations are being conducted, and when a single unified control over all traffic on a road net is necessary. (For further details see FM 29-5.)

b. Techniques.—The three control techniques are—

(1) Intersection regulation (also regulation of other bottlenecks).

(2) Regulation by escorts.

(3) Regulation by patrols.

A combination of (1) and (3) above is normally required in area control; (2) is most often used in organizational control. However, all techniques are interwoven, as an escorted column may often pass through a controlled area, and escort personnel often do intersection duty.

■ 107. TRAFFIC CONTROL PERSONNEL.—Traffic control personnel are used primarily to keep traffic moving in conformity with the traffic plan. Under organizational control, personnel involved consists of specialists from the organization involved; under area control, traffic control duties are usually performed by military police detailed by the headquarters responsible for traffic control in the area. The intensive specialized training and equipment needed for this important duty are beyond the scope of this manual; these subjects are covered in great detail in FM 29-5 and TF 11-262. All drivers should be familiar with the signals employed by military police as described in FM 29-5.

■ 108. ROUTE MARKING.—Markers may be used to aid a specific march, or to aid general traffic movements within an area. *Individuals should not be posted where signs can be used with equal effectiveness.* The mission of marking details is to post signs which will guide traffic over proper roads and protect it from traffic conflict and road hazards. The detail will need a supply of all types of signs, tools for installation, a marked route map, and a light vehicle. If possible, signs should be installed well in advance of the column,

preferably the day prior to the march. Signs placed by column personnel are usually picked up under supervision of the column trail officer (see par. 60). When movements are to be made at night, the route should preferably be marked during daylight. If the column is to be led by a guide, the guide should go over the marked route during daylight, and if possible, also at night.

■ 109. PASSAGE OF COLUMNS.—*a.* Considerations affecting overtaking and passing of individual vehicles (par. 15) also apply generally to columns. Permission should be obtained from the trail officer of the overtaken column before passing is begun. Traffic control personnel are posted at the head and tail of the slower or halted column to facilitate the passing operation, or to prevent it when passing is unsafe. When the lane to be used for passing is clear of traffic for the entire length of the column being passed, the guard at the tail end of the halted column signals the faster column to move by. When the last element of the faster column has cleared the head of the halted column, normal operations are resumed. Passage of columns should be made at prearranged suitable locations and during a scheduled halt of the slower column whenever possible.

b. On roads where the number of lanes available for movement is equal to the number of lanes occupied by the two columns concerned, escort personnel from each column are responsible that all vehicles are cleared from the counterflow lane before the arrival of the head of their respective columns. When any column contains vehicles of unusual length, such as ponton semitrailers, it may be necessary to post guards at curves to prevent conflicts resulting from the rear sweep of these vehicles during the passing operation.

c. When a one-lane road must be used by columns proceeding in opposite directions, alternate one-way operation may be employed, utilizing a traffic control post at each end of the road. If possible these posts should be connected by radio, wire, visual, or sound communication. When rapid communication between ends of the road are not available, the last vehicle in each group should be distinctively marked by traffic post personnel admitting group to roadway. This distinctive marker is picked up by traffic post personnel at exit of roadway.

■ 110. HALTS.—Wherever possible, halts should be confined to locations where the halt will not interfere with other traffic on the roadway. Vehicles should be moved off the road (preferably to the right) into bivouac or parking areas, sidings, minor roadways. If it is necessary to halt on the road, all vehicles must park as far to the right as practicable. Intersections, railroad crossings, or other cross flow facilities should not be blocked (or sight distances unnecessarily limited) by halted vehicles. When a halt must be made to permit passing of columns, such halt should be timed to coincide with a regular rest or mess halt. Detailed information pertaining to halts for march columns is given in paragraph 62.

■ 111. TRAFFIC ESCORTS.—*a. Functions.*—(1) The primary functions of a traffic escort are to guide a column and to protect it from interference by vehicles that are not a part of the column. Signs and signals are used whenever possible to replace personnel and thus reduce the number of men required in the escort party or release them for other duties. Column guidance may be accomplished by designating a guide to lead the column, by stationing guides at locations where the column may stray from the march route, or by using appropriate markers.

(2) Guides are especially useful at night, or when it is necessary to leave the road and travel over short stretches of difficult ground, such as along a detour or into a bivouac or assembly area. If the movement is to be made after dark, guides should go over the road during daylight (and preferably also after nightfall) to observe and mark every detail that will identify the route during darkness. Traffic escorts establish temporary control posts successively forward at all locations where control is needed. This procedure is especially important prior to entry of the column on one lane *open* roads when there is a possibility of meeting another column at a location where passing is impossible.

b. Posting escorts.—When escort personnel are mounted on solo motorcycles, or use other individual transportation having similar mobility characteristics, they may again be posted forward as needed. Their greater speed allows them to proceed ahead of the column to duty at another location. Ordinarily, however, escort personnel should not be required to double a moving column. The following system utilizes

fewer vehicles, but requires more personnel:

(1) Before starting out to post the route, the escort officer distributes the escort detail in vehicles in such a manner as to leave one vehicle empty.

(2) The detail moves out sufficiently far in advance to permit posting of personnel without interfering with the marching column.

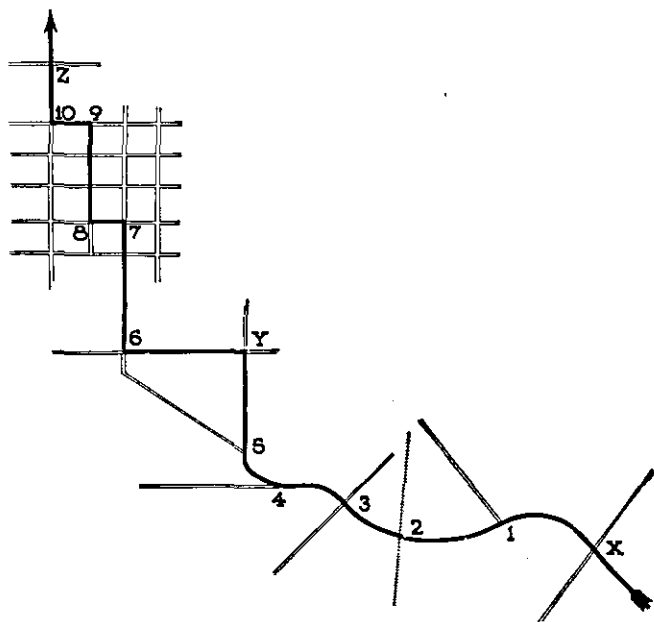

FIGURE 10.—Method of posting escort personnel.

(3) Assume that the escort commander has three vehicles in the order A, B, C, from front to rear, and that B and C each carry five members of the escort, while A carries only the escort commander and driver. Let point X be the position of the first location to be posted (fig. 10).

(4) On or before reaching point X, the escort commander gives to the driver of vehicle A instructions for posting point X. The driver of vehicle A parks his vehicle where it will not interfere with traffic and assumes the duties of his post.

(The same procedure may be used if two or more persons are required at the post.) The escort commander then mounts vehicle B, now at the head of the column, where he is able to control movements of the escort party and be in position to give instructions for posting the next location. In a similar manner, personnel from vehicle B post locations in the order 1, 2, 3, 4, and 5.

(5) Vehicle B is left at point Y, the driver being used for post duty at that point. The remainder of the detail moves on ahead and posts locations from vehicle C in the same manner.

(6) When the march column clears point X, vehicle A follows and picks up personnel at locations 1, 2, 3, 4, and 5. It then joins the rear of the column in a position just ahead of the trail officer. In a like manner, when the column and vehicle A clears point Y, vehicle B follows and picks up post personnel at successive locations 6, 7, 8, 9, and 10. These loaded vehicles remain at the rear of the column until a halt or other condition permits them to pass the column and rejoin the escort commander.

(7) If posts are numbered consecutively from the beginning to the end of the route, the escort commander and his assistants will have a means of checking whether any post has been missed. The error will be detected shortly after it occurs and only a short distance will have to be traveled to pick up a missing man. A distinctive flag or sign should be placed on the trail car so that members of the escort party can easily identify the end of the column.

■ 112. **TRAFFIC PATROLS.**—Traffic patrols, mounted in small, highly maneuverable trucks or in motorcycles, are used in area control to provide liaison between key control points, supervise traffic between such points, and provide frequent checking of critical points on the road net when road or traffic blocks are most likely to develop. (See FM 29-5.)

■ 113. **NIGHT OPERATION.**—Traffic control at night is complicated by reduced visibility. The tactical situation will determine whether headlights are permitted, or whether operation will be subject to blackout restrictions.

a. With headlights.—Traffic control at night when headlights are used is similar to daylight control except that transmission of visual signals is more difficult and special

attention must be given to marking the route for night operation (see FM 29-5).

b. Under blackout conditions.—When movements must be made with secrecy, and blackout driving lights, blackout marker lights, or no lights at all are allowed, special control measures are needed. Signals usually given by hand must be transmitted by special means, and their range is greatly reduced. Efficiency of messenger service and motorcycles is decreased because of decreased mobility. Road time is increased, and rates of march are more difficult to estimate and maintain. Plans should be as detailed as possible; and all arrangements for coordination should be completed during daylight. Ordinarily, one-way traffic will facilitate execution and control of movements under blackout conditions. All routes should be carefully reconnoitered, and traffic control personnel, signs, and signals should all be posted prior to darkness.

SECTION VI

TRAFFIC AIDS

■ 114. **TRAFFIC MAPS.**—*a. General.*—Types of maps used primarily for traffic purposes are indicated in the following subparagraphs. Traffic information presented in graphic form through use of symbols (see par. 115) may include the following items:

- (1) Road net.
- (2) Designation and numbering of specific routes.
- (3) Identification of traffic terminals, cities, towns, intersections, traffic establishments, and important terrain features.
- (4) Road data (see par. 88).
- (5) Direction of traffic movements.
- (6) Control classification of routes.
- (7) Traffic flow.

b. Strip map.—Strip maps are particularly useful to commanders of smaller units in organizational column control. They are used to give a schematic picture of a route of march and, if desired, information and restrictions pertaining thereto (see fig. 11). Strip maps should be reproduced in quantity and supplied to all personnel concerned (including column commanders, control officers, trail officers, serial and

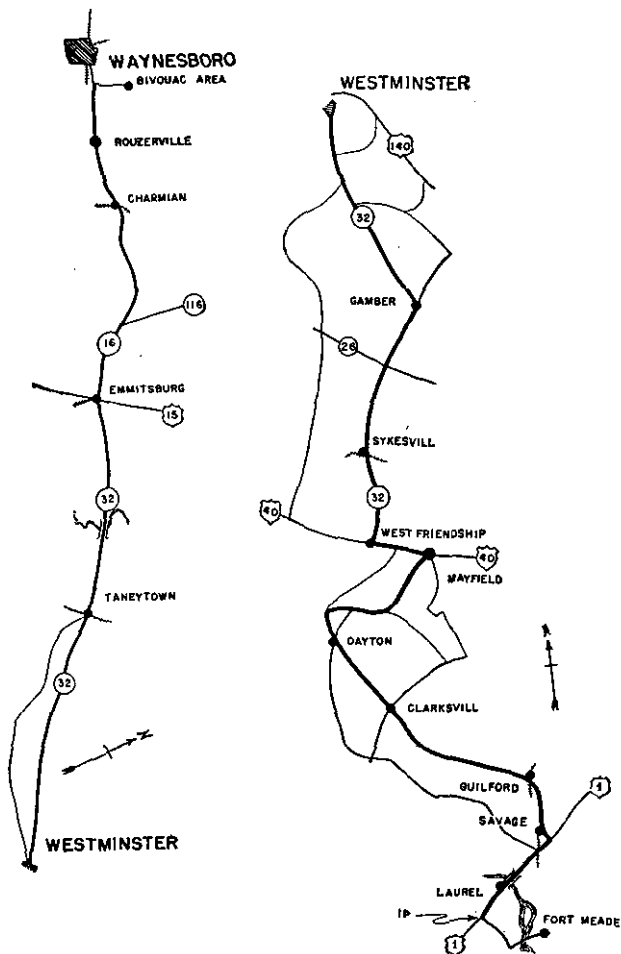

FIGURE 11.—Strip map.

march unit commanders, vehicle drivers, guides, and escort personnel). A strip map is especially needed when drivers operate independently or when distances between vehicles are so large that individual vehicles are liable to become separated from their column. When strip maps cannot be

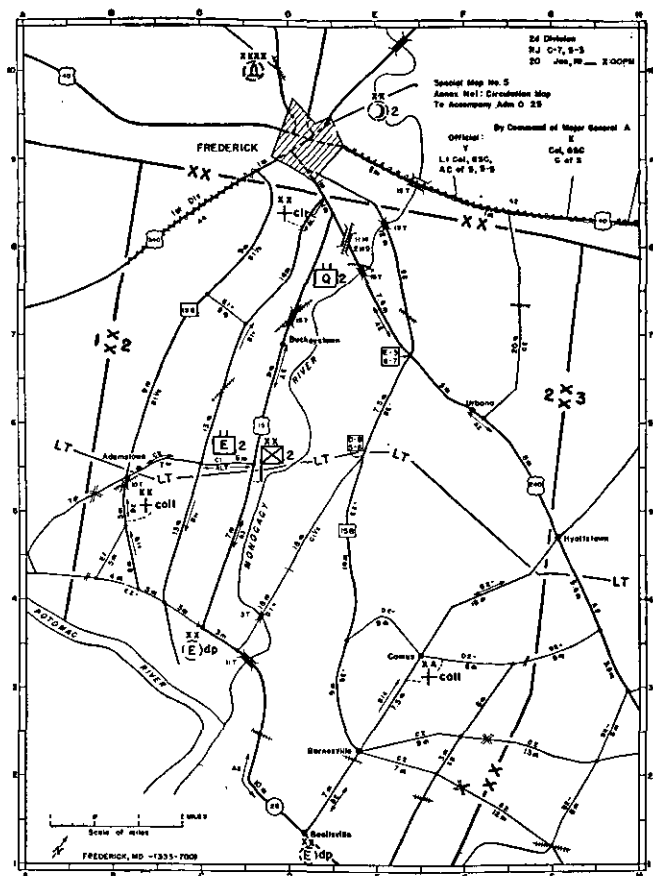

FIGURE 12.—Circulation map (see par. 115 for meaning of map symbols).

made available, march personnel should be provided with a list of places through which they must pass, numbers of highways to be used, and detailed directions regarding turns to be made en route.

c. Circulation map.—Circulation maps (fig. 12) are used by higher headquarters to indicate a road net, or system of routes, and necessary information, and traffic restrictions pertaining thereto.

d. Traffic planning map.—Traffic planning maps are used by higher headquarters in preparing the traffic plan. Strip and circulation maps may be derived from this map.

■ 115. MAP SYMBOLS (see FS 5-1).—*a. General.*—Symbols listed in this paragraph may be used to present traffic information in convenient and concise form on traffic maps. Other map symbols are covered in FM 21-30. Road information shown on a traffic map applies throughout the length of road between points shown by heavy dots or crossbars.

b. Road types.

Physical characteristics	Types of surface		
	All weather		Earth
	Concrete, macadam, or other stabilized material	Gravel, crushed rock or other unconsolidated material Dusty when dry	Dusty when dry; muddy when wet
Good road (gentle grades, gradual curves, smooth surface, good foundation).....	A	C	E
Poor road (steep grades, sharp curves, rough surface, or poor foundation).....	B	D	¹ F

¹ Probably impassable in wet weather.













c. Traffic lanes.

- 1, 2, 3, etc. Placed after road type symbol to indicate roadways suitable for continuous traffic in one, two, three, etc., lanes, respectively.
- 1+ One-lane roadway having occasional passing locations, and suitable for very light two-way traffic.
- 1½ One-lane roadway having frequent passing locations, and suitable for light two-way traffic.
- 2+ Two-lane roadway having occasional one-lane defiles, and suitable for moderate two-way traffic.



d. Road information.









- H Followed by numeral indicates clearance height in feet between surface of roadway and overhead obstruction. (For arches see par. 92.)

- W** Followed by numeral indicates clearance width in feet provided at most critical location. Symbol is preceded by numeral to indicate more than one such lane (e. g., 2 W 9 indicates 2 separate lanes, each of which provides a clearance width of 9 feet).
- T** Preceded by numeral indicates tonnage limitation. (See par. 94.)
- M** Preceded by numeral indicates distance in miles.
- I** Followed by numeral indicates average interval of time (time-distance) in minutes required by motor vehicles during daylight to travel section of road shown.

-  Movable road block.
-  Permanent road block.
-  RR grade crossing.
-  RR above road.
-  RR beneath road.
-  Boundary between two sections of roadway.
-  Impassable road.
-  Bridge.
-  Tunnel.
-  Rotary traffic.
-  Turn-around location.
-  Line drawn parallel to one-lane road indicates length of roadway where passing is possible.

e. Traffic control.

-  One-way traffic.
-  Two-way traffic.
-  Alternate one-way traffic direction, alternately). (roadway used in either
- } Supervised roads (directions of permissible movements shown by arrow).

-  Dispatch route (operated by schedule system).
-  Reserved route (can be used by specific traffic only).
-   Federal and State route markers, respectively.
-  Military route marker.
-   Traffic post (or unit); traffic headquarters.
-  Conventional sign for marked road intersection (atlas-grid system).
- L T— Line beyond which any lights (including blackout lights) are prohibited.

■ 116. METHOD OF INDICATING ROUTES.—A standard method of identifying all main Federal and State routes is in use within the continental limits of the United States. This system is employed for military use, and may be extended, where needed, to routes not yet marked. In general, north-south Federal routes are numbered with odd numbers, beginning with the chief north-south route nearest the eastern seaboard as route 1. East-west routes are numbered with even numbers, beginning with the chief east-west route nearest the northern boundary as route 2. These route numbers are always prefixed with the letters US and are shown on traffic maps as numerals within a shield. State routes are usually numbered similarly to the system employed for Federal routes, except that the name or symbol of the State is used in lieu of the US. They are shown on traffic maps as numerals within a circle.

■ 117. SIGNS.—A traffic sign is a marker mounted on a fixed or portable support whereby notice is given in the form of words or symbols for the purpose of regulating, warning, or guiding traffic. Signs are employed whenever possible in lieu of traffic personnel. When there is danger that signs may be useful to the enemy, however, signs should be destroyed, and guides used instead. Specific uses of signs include identification of places, marking of routes, indica-



STOP



LEFT CURVE



RIGHT CURVE



HILL

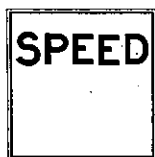

RAILROAD CROSSING

SLOW
(Speed Superimposed)BRIDGE
(Add Figure)SPEED
(Add Figure)ONE WAY
(Add Arrow)

NO PARKING



ROAD CLOSED

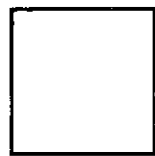

BLANK

① Regulatory and warning signs.

FIGURE 13.—Military traffic signs.



GAS D.P.
(Add Arrow)



RAIL HEAD
(Add Arrow)



WATER POINT
(Add Arrow)



RATION DUMP
(Add Arrow)



DETOUR
(Add Arrow)

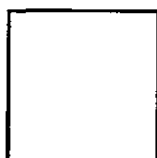

BLANK

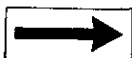

ARROW

ABC

LETTERS



DIRECTION

123

NUMBERS

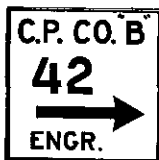

ORGANIZATION
WITH ARROW



LOCATION
(Atlas Grid)

② Guide signs.

FIGURE 13.—Military traffic signs—Continued.

tion of directions and distances, and indication of special situations and traffic regulations. In combat areas, these signs are usually installed by engineer troops. (See FM 5-10.) Standard military signs are shown in figure 13.

SECTION VII

LOGISTICAL DATA

■ 118. GENERAL.—This section provides miscellaneous statistical and technical information useful to commanders of small units in the detailed planning of motor movements. Additional data will be found in FM 101-10.

■ 119. AVERAGE DAY'S MARCH AND RATE OF MARCH.—*a. March day.*—During peacetime, and during war when tactical considerations do not interfere, the following may be used as a guide in planning an average day's motor march:

- (1) Preparation for the march..... 1 hour
(Includes time for breakfast, inspection of vehicles, and breaking camp.)
- (2) Running time..... 7 to 8 hours
(Includes all halts except noon halt.)
- (3) Halt for lunch and refueling of vehicles..... 1 hour
(This halt may be shortened under war-time conditions.)
- (4) Inspection and servicing of vehicles after arrival at camp..... 1 hour

b. Rates of march and distances.—Rates of march to be adopted and the daily distance that can be covered will vary according to conditions encountered en route. Table I can be used as a guide for motor marches.

TABLE I
RATES AND LENGTHS OF MARCHES

	1	2	3	4	5	6 ¹	7
1	Unit	Average rates of march (mph) ⁴				Length of March (average)	Remarks
		On roads		Across country			
		Day	Night	Day	Night	On roads (miles per day)	

INFANTRY ⁵

2	Foot troops.....	2½	2.....	1½	1	12-15 for a division 15-20 for smaller units	Length of march increased with well seasoned troops marching on good roads in favorable weather when required by the tactical situation. ¹
---	------------------	----	--------	----	---	---	---

ARTILLERY ³

3	Horse-drawn.....	3½	3.....	3	2	20	
4	Pack (less motor elements).	3½	3.....	3	2	20	
5	Truck-drawn, light and antiaircraft.	25	25 (lights)..... 10 (no lights).....	8	5	175	
6	Truck-drawn, medium, howitzer.	20	20 (lights)..... 10 (no lights).....	8	5	140	
7	Truck-drawn, heavy.	15	15 (lights)..... 10 (no lights).....	8	5	100	
8	Tractor-drawn, heavy.	5	5.....	3	2	40	

¹ The rate of march of a column composed of elements with different rates of march is regulated by that of the slowest element.

² Greater distances than those given in column 6 may be covered under forced march conditions.

³ Horse artillery marches at the rates of horse cavalry (line 9).

⁴ Rates shown apply primarily to movement in close column, and may be increased for small commands under favorable conditions, or for movement in open column.

⁵ For movement over mountainous terrain, an additional allowance of 1 hour should be made for each 1,000 feet of climb.

TABLE I—Continued
 RATES AND LENGTHS OF MARCHES—Continued

	1	2	3	4	5	6 ²	7
1	Unit	Average rates of march (mph) ⁴				Length of March (average)	Remarks
		On roads		Across country			
		Day	Night	Day	Night	On roads (miles per day)	

CAVALRY

9	Animal elements...	6	5.....	5	4	35	Under conditions requiring maneuver, these rates may be increased.
10	Cars, armored or scout.	35	35 (lights).... 10 (no lights)...	10	5	200	

ARMORED

11	Tanks, light and medium (units under own power).	25	25 (lights).... 10 (no lights)...	15	5	150	Convertible medium tanks move off hard-surfaced roads on tracks only.
----	--	----	--------------------------------------	----	---	-----	---

MISCELLANEOUS

12	Animal-drawn trains.	3½	3.....	1½	1	20	
13	Trucks, ambulances, motorized units (except medium and heavy artillery).	25	25 (lights).... 10 (no lights)...	8	5	175	
14	Cars, passenger...	35	35 (lights).... 10 (no lights)...	8	5	250	

■ 120. SIZE AND WEIGHTS OF VEHICLES.—Dimensions and weights of various vehicles are shown in FM 101-10.

■ 121. ROAD SPACES AT HALT.—The following figures are averages, based on experience. The figures shown for motor elements, trailers, and guns and howitzers take into consideration the average length per vehicle and allow sufficient space for individual vehicle maneuvering.

	Yards
<i>a. Foot troops.</i>	
In column of fours, per man.....	0.6
In column of threes, per man.....	0.8
In column of twos, per man.....	1.2
Single file, per man.....	2.4
<i>b. Animals.</i>	
In column of fours, per animal.....	1.0
In column of twos, per animal.....	2.0
Single file, per animal.....	4.0
For large units, column of fours.....	1.5
For large units, column of twos.....	3.0
Horse-drawn field artillery, per animal.....	3.0
<i>c. Bicycles.</i>	
In single file.....	4.0
<i>d. Motor elements.</i>	
Motorcycles (solo or w/s/c).....	5.0
Passenger cars.....	7.0
Trucks, utility (¼- to 1-ton).....	7.0
Trucks, light (1¼- to 2-ton).....	9.0
Trucks, medium (2¼- to 4-ton).....	13.0
Trucks, heavy (5-ton or over).....	13.0
Tractors, light or medium.....	5.0
Light tanks.....	7.0
Medium tanks.....	8.0
Scout cars.....	8.0
Half-track vehicles.....	8.0
Water tank truck (750 gal.).....	8.0
Mobile water purification unit.....	8.0
Map reproduction unit.....	8.0
Prime movers for ponton semitrailers.....	8.0
Mobile map reproduction train.....	17.0
<i>e. Trailers (less prime movers).</i>	
1-ton, cargo.....	4.0
2-wheel, van.....	6.0

	Yards
10-ton, tilting bed tandem.....	5.0
Searchlight M1AA.....	6.0
2-wheel ponton trailer.....	11.0
10-ton, ponton semitrailer and dolly.....	15.0
25-ton, ponton semitrailer and dolly.....	12.0
8-wheel, platform.....	12.0

f. Guns and howitzers.

75-mm guns.....	7.0
105-mm howitzers.....	8.0
155-mm howitzers.....	8.0
155-mm guns.....	11.0
3-inch antiaircraft guns.....	9.0
37-mm guns, antitank.....	5.0
37-mm guns, antiaircraft.....	7.0
240-mm howitzer bogies.....	14.0
240-mm carriage bogies.....	10.0

■ 122. TIME LENGTH, TRAFFIC FLOW, AND DENSITY OF MOTOR COLUMNS.—*a. Time length.*—(1) Time length of a motor column may be obtained by multiplying number of vehicles in column by average intervehicular headway of column. Thus a column composed of 300 vehicles having an average intervehicular headway of 0.10 minutes (6 sec.) would have a time length of 300×0.10 or 30 minutes (600 vehicles per hour).

(2) Time length of open or close columns may likewise be obtained by reference to figure 14. To use figure, read speed on horizontal scale, move upward to close column line or appropriate speedometer multiplier and read time length of 100 vehicles on vertical scale. Multiply time length obtained by number of vehicles in column and divide by 100. The quotient is time length of column in minutes.

(3) When hourly flow is known, time length of column in hours may also be computed by dividing number of vehicles in column by hourly flow. Thus an infiltration column of 200 vehicles dispatched at rate of 50 vehicles per hour would have a time length of $200/50$ or 4 hours. However, time length of an infiltration column en route or at end of march will ordinarily be somewhat greater than initial time length.

b. Infiltration.—Rates of dispatch (traffic flow) of an infiltration column corresponding to traffic density obtained at various average speeds are indicated as follows:

Maximum traffic density desired (vehicles per mile)	Corresponding intervehicular lead (yards)	Average rate of dispatch (vehicles per hour) for average speeds expected							
		5 mph	10 mph	15 mph	20 mph	25 mph	30 mph	35 mph	40 mph
2	880	10	20	30	40	50	60	70	80
3	587	15	30	45	60	75	90	105	120
4	440	20	40	60	80	100	120	140	160
5	352	25	50	75	100	125	150	175	200
10	176	50	100	150	200	250	300	350	400

c. Close column.—Traffic characteristics of close column marches of short duration are as follows:

Speed (miles per hour)	Intervehicular lead (yards)	Traffic density (vehicles per mile)	Traffic flow (vehicles per hour)	Intervehicular headway (minutes)	Maximum tonnage hauled by 2½-ton trucks (per hour)
5	17	102	508	.118	1,270
10	22	79	790	.076	1,975
15	28	63	938	.064	2,345
20	36	49	970	.062	2,425
25	44	40	1,000	.060	2,500
30	53	33	1,000	.060	2,500
35	62	29	1,000	.060	2,500
40	70	25	1,000	.060	2,500
45	79	22	1,000	.060	2,500

NOTE.—Foregoing figures are for single lane movements for short distances only. They contain a factor of safety of approximately twenty percent. (Traffic flow as high as 1,254 vehicles per hour has been attained under test conditions.) In computing data, use slowest speed expected between halts. It should be noted that practically the same tonnage can be hauled in close column past a given point at 25 mph as can be hauled at 40 mph. Thus traffic capacity of a given roadway will be utilized to the same advantage at all speeds from 25 mph to 45 mph except that there will be less wear and tear on the roadway and safer operation will prevail at the lower speeds. However, the higher speeds are advantageous when higher rates of march are desired in order to complete a movement in a minimum of time and thus obtain greater utilization of vehicles (as in shuttling movements), or to travel greater distances within a given period of time (increase length of march per day).

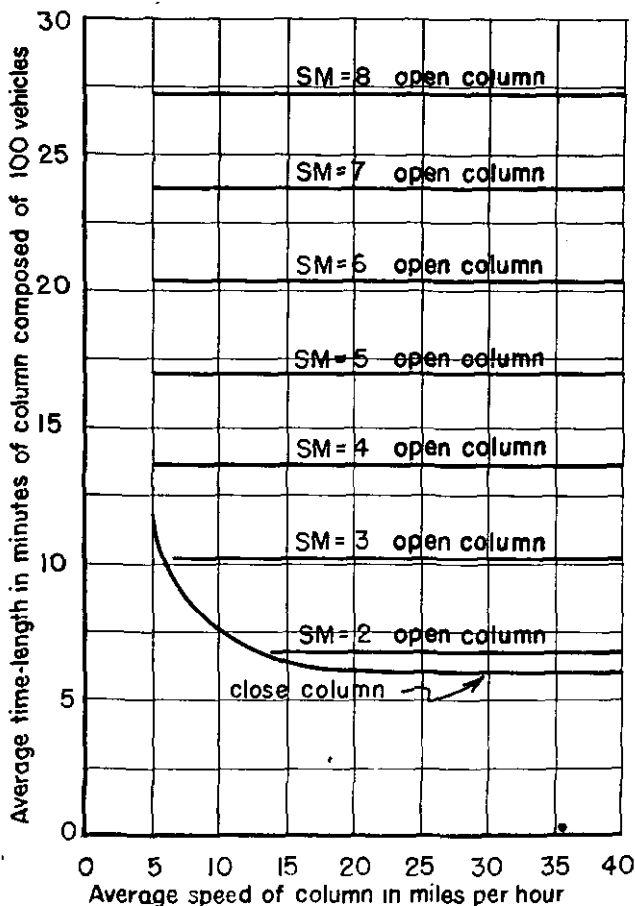

FIGURE 14.—Average time length of open and close motor columns at various speeds.

d. Open column.—Data tabulated below indicate traffic flow, traffic density, and intervehicular headways corresponding to selected speedometer multiplier and vehicle speeds. For example of method used to determine proper speedometer multiplier, see paragraph 58c.

Speedometer multiplier	Traffic density (vehicles per mile) for average speeds expected							Traffic flow at all speeds (vehicles per hour)	Inter-vehicular headway at all speeds ¹ (minutes)	Maximum tonnage hauled by 2½-ton trucks (per hour)
	5 mph	10 mph	15 mph	20 mph	25 mph	30 mph	40 mph			
2	(²)	(¹)	(¹)	44	35	29	22	880	0.07	2,200
3	(¹)	(¹)	39	29	23	19	15	587	.10	1,467
4	88	44	29	22	18	15	11	440	.14	1,100
5	70	35	23	18	14	12	(²)	352	.17	880
6	58	29	19	15	12	(²)	(²)	293	.21	733
7	50	25	17	13	(²)	(²)	(²)	250	.24	625
8	44	22	15	11	(²)	(²)	(²)	220	.27	550

¹ Intervehicular headway in seconds is approximately equal to two times the speedometer multiplier.

² Drivers operate as in close column.

³ Drivers operate as in infiltration.

■ 123. AVERAGE ROAD SPACE OF MOTOR COLUMNS AT VARIOUS SPEEDS.—a. Average road space (in miles) of motor columns moving at various speeds may be obtained by dividing the number of vehicles in column (disregarding trailers) by the average density (number of vehicles per mile). (See par. 122 for vehicle densities.)

b. Average road space may also be obtained by reference to figure 15. To obtain road space, read speed on horizontal scale, move upward to line marked close column or to line indicated by appropriate speedometer multiplier, and read road space of 100 vehicles on vertical scale. Multiply this reading by number of vehicles in the column and divide by 100. The quotient is road space of column in miles.

■ 124. HAULING CAPACITY OF COLUMNS.—The maximum rate per hour at which tons of cargo or number of troops can be hauled by a column is obtained by multiplying the traffic flow per hour by the tonnage, troop, or cubic capacity of vehicles in the column. See paragraph 122c and d for hauling capacity of columns composed of 2½-ton trucks.

■ 125. TROOP CAPACITY OF VEHICLES.—The troop-carrying capacity of motor vehicles transporting no loads of matériel

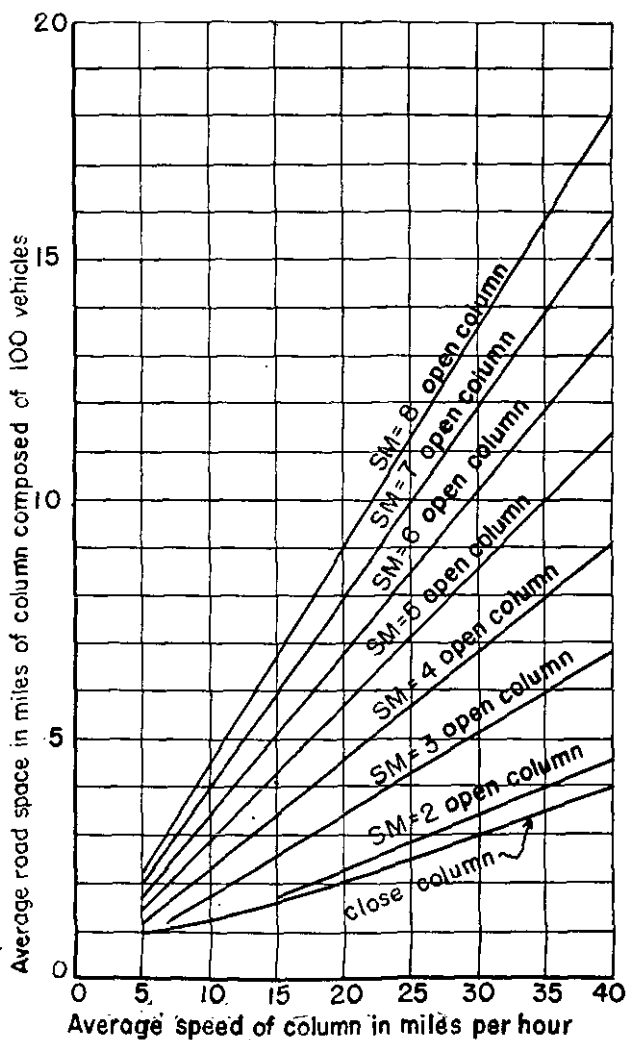

FIGURE 15.—Average road space of open and close motor columns at various speeds.

other than individual arms and equipment of troops is as follows:

Trucks, 1/2-ton-----	5
Trucks, 1 1/2-ton-----	15
Trucks, 2 1/2-ton-----	25

Loads listed are in addition to driver and one man on the front seat. For distances greater than 75 miles, the above figures should be reduced.

■ 126. TROOP LOADING AND UNLOADING TIME.—With troops properly disposed at loading site, average time required to load and unload personnel and their individual equipment into and out of military trucks is as follows:

	<i>Average time¹ required</i>
To load-----	15 minutes
To unload-----	10 minutes

¹ Well-trained troops, properly organized and prepared, can load and unload in half this time under good conditions.

■ 127. ENTRUCKING AND DETRUCKING.—Computation of trucks required, and correlations necessary for entrucking and detrucking are facilitated by use of tables. Truck requirement form, shown as table II, is self-explanatory. For a complex

TABLE II.—Truck requirement table for troop movement

Unit and group number ¹	T/O strength		Actual strength		Transportation in organic motors (men)	Strength for which transportation must be furnished (men)	Number of trucks required								
	Men	Trucks	Men	Trucks			1/4-ton	1 1/4-ton	2 1/4-ton	4-ton	6-ton	Other	Total ²		

¹ Use same group numbers as shown in column 1 on work sheet.

² Transcribe to column 2 on work sheet.

movement, work sheets shown as table III will be of assistance in preparing data required for an entrucking (detrucking) table. (See par. 61 for discussion of entrucking and detrucking.)

TABLE III.—Work sheet for preparation of entrucking table

RP=Regulating point.
IP=Initial point.

EP=Entrucking point.

1	2	3		4	5	6	7	8	9	10	11
		In	Out								
Group number (order of clearance of IP)	Number of trucks assigned	Time-length of motor transport (minutes)		Hour head passes RP (For group 1: hour head of column arrives at RP plus delay of head of column at RP) ¹	Time distance RP to EP (minutes)	Hour head arrives at EP (4+5)	Time distance EP to IP (minutes)	Time that group is held at EP before entrucking begins (minutes) (9-8)	Hour entrucking begins (10-loading time)	Hour head leaves EP (11-7)	Hour head of group passes IP :
1											
2											
3											
4											
5											
6											
7											
8											
							Column clears			IP →	(6)

¹ For succeeding groups add to the hour at which the head of preceding group passes RP the time length of the preceding group (column 3) plus additional delay, if any, of the group considered.

See page 114 for footnotes 2, 3, 4, and 5.

■ 128. TIME, DISTANCE, AND SPEED.—Necessary conversions of time, distance, and speed are facilitated by use of nomograph given in figure 16.

■ 129. MARCH GRAPHS AND MARCH TABLES.—*a.* The field order for a march may be accompanied by a march table, particularly when the details of the march are not subject to change and can be foreseen. The march table affords a convenient means of transmitting to subordinates the many details pertaining to the march, the inclusion of which in the body of the field order would tend to complicate or make it unduly lengthy.

b. A march graph is the simplest method of obtaining data required for a march table or order. It shows the approximate location at any hour of the head or tail of each serial, providing the march proceeds as scheduled. The march graph is prepared on cross-section paper, using one sheet for each route. The vertical scale to the left, with point of origin at the bottom, serves as a distance scale in miles and should show the relative locations along the route of critical points where coordination of the movement is required. The horizontal scale provides a time scale in hours, beginning at the left with the earliest hour at which the first serial may start the march.

c. A serial is represented on the graph by a horizontal line, drawn to scale, equal to the time length of the serial. This

¹ To find the approximate [see (4) below] time the head of the first group should pass the initial point use the following formula:

Hour the head of the first group passes the initial point = the hour head of first group passes regulating point + the greatest time consumed by group in traversing route from RP to IP and in loading.

² The hour the head of any succeeding group should pass the initial point = hour that the head of the preceding group passes the initial point + the time length of that group. Any prescribed time intervals should be added to the "out" time length of all groups except the last.

³ When time entries on the work sheet are completed, compare entries in column 6 and column 9. If any or several groups are timed to begin loading before arrival at the entrucking point determine the group having the greatest difference in minutes between time of arrival at the entrucking point and the time loading is to begin. Add to the first figure in column 11 this difference in minutes and adjust all subsequent figures accordingly. This eliminates the approximation that may occur as a result of the application of the formula given in footnote 2.

⁴ To find the hour last group clears the initial point, add the last entry in column 3 to the last entry in column 11.

TABLE IV

ANNEX NO. ----- TO FIELD ORDERS NO. -----
 Maps: Title
 Place
 Date and hour

ENTRUCKING TABLE 1

1	2	3	4	5	6	7	8	9	10
Group No.	Troops ⁽²⁾	Motor transport assignment	Regulating point and date and hour head passes same	Route from regulating point to entrucking point	Entrucking point and hour head reaches same	Hour entrucking begins	Hour head leaves entrucking point	Route from entrucking point to initial point	Initial point and hour head passes same

(Authentication)

(Signature)

Column clears initial point at -----

¹ This form will be used for a detrucking table by substituting detrucking for entrucking.

² It should be shown what elements (e. g., foot troops, carts, kitchens, motors, animals, etc.) of each tactical unit noted in this column are to be moved by motor transport.

line is plotted opposite the point on the vertical scale, corresponding to the initial point of the serial; the left of the line being plotted above the hour, on the horizontal scale, at which the serial begins the march. From this left end a line is drawn upward at a slope representing the rate of

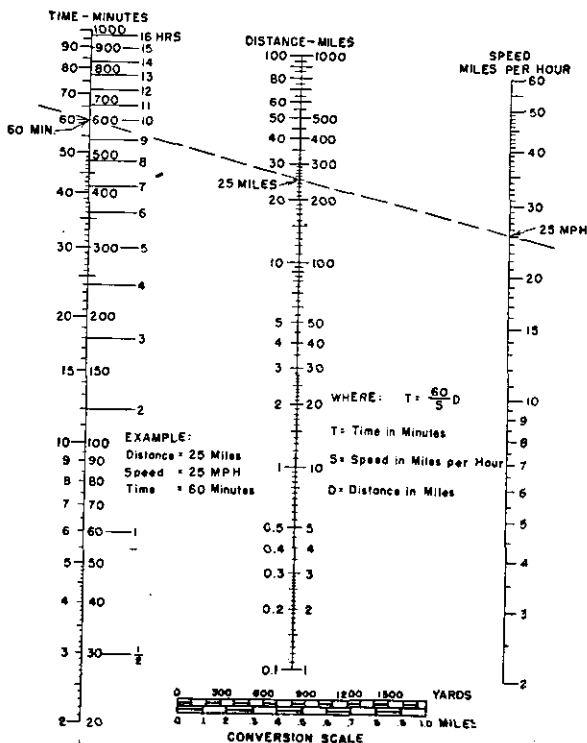

FIGURE 16.—Time, distance, and speed nomograph.

march (at 10 miles per hour the slope equals 10 miles on the vertical to 1 hour on the horizontal scale). This sloping line represents the march of the head of the column. The intersection of this line with the horizontal line from any point along the route, if projected down to the time scale, will show the time the head arrives at such point. A line

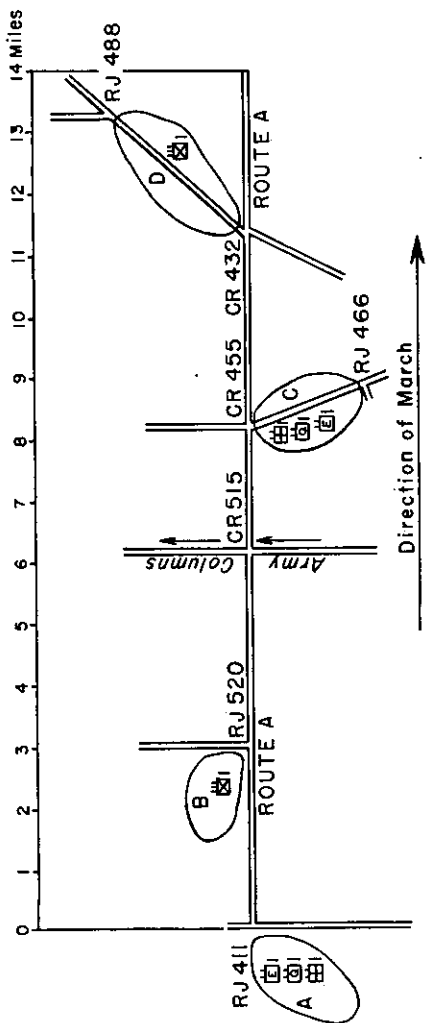

FIGURE 17.

drawn from the right end of the horizontal line representing the time length of the serial and parallel to the line representing the head of the column will represent the tail of the serial. Time of clearances may be obtained as explained for the head of the serial. The movement or location of a unit after it leaves the route represented on the distance scale, or passes the rear boundary of its destination (new bivouac area), may be shown on the graph by dotted lines.

d. If the hour at which a march must be completed is the only time factor known, the graph may be constructed starting with the tail of the column at the destination and working back to obtain the hour of starting for the head of the column. The graphs of all serials may be adjusted to allow for crossing columns or other interferences. The need for and the means of making such adjustments may be visualized. In preparing the march graph a safety factor of 15 to 30 minutes should be allowed between serials at critical points on the route. In the march table this time is divided between serials, the major portion usually being assigned to the leading serial. A small gap of about 5 minutes should be reserved during which the route is clear.

■ 130. EXAMPLES OF MARCH GRAPHS AND MARCH TABLES.—a. The division commander has directed that the 1st Engineer Battalion, 1st Quartermaster Battalion, 1st Medical Battalion, and the 1st Infantry, in army reserve, move under cover of darkness from their present bivouacs, areas A and B to areas C and D, beginning at 7:00 PM, 17 October 19—, under the following conditions:

(1) Movement to be made without lights and to be completed prior to 5:00 AM, 18 October 19—.

(2) Route A is available for the movement but CR 515 is reserved for army columns from 11:36 PM to 12:06 AM and from 2:36 AM to 3:00 AM.

b. The following example of march graph—route A is the graph used by the division staff, 1st Division, in planning the march.

NOTES

1. Time lengths:

(a) Serial 1—2,650 men on foot in column of threes at 2 mph (chart, par. 37, FM 101-10) = 36 minutes.

(b) Serial 2—250 vehicles at 10 mph (chart, fig. 14) = 19 minutes.

(c) Serial 3—315 vehicles at 10 mph (chart, fig. 14) = 23 minutes.

2. O indicates remark in march table.

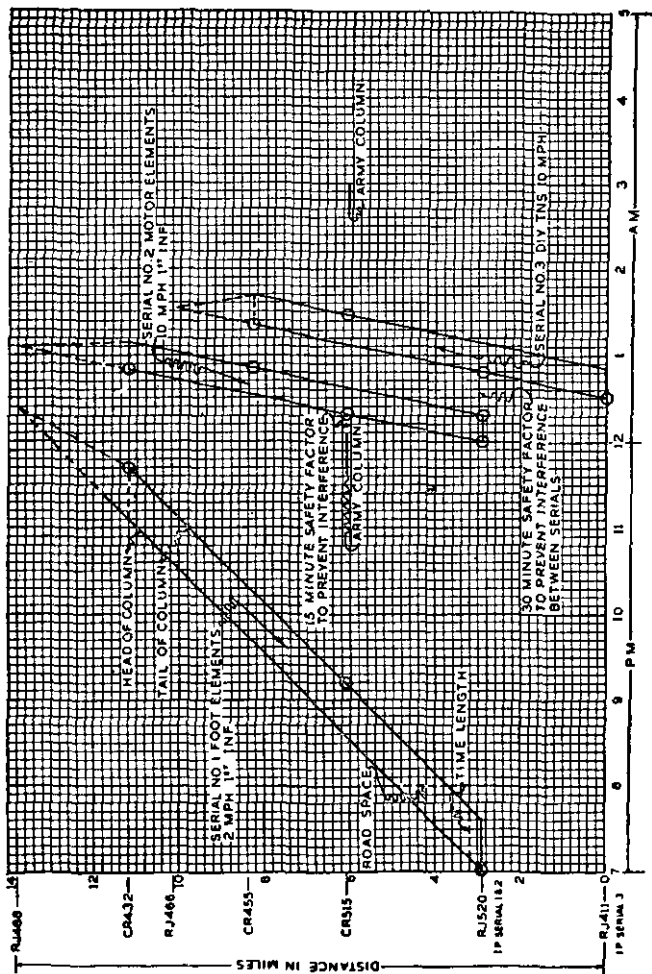

FIGURE 18.

ANNEX No. 1 TO FO 2
MARCH TABLE

Map-Operations Map

1st Div

 Pennsylvania (372-745), Pa
 17 Oct 19--, 3:00 PM

Serial No.	Organization and commander	Present location	Route	Location by 5:00 A.M., 18 Oct.	March			Control of movement			Remarks
					Rate (miles per hour)	Type	Time length (minutes)	Location	Earliest allowable arrival time	Latest allowable arrival time	
1	Col A 1st Inf Comdg Foot Troops 1st Inf 2,650 men	Area B	A	Area D	2	Column of 3's	36	RJ 520 (IP) CR 515 CR 432	7:00 PM	10:10 P M 12:35 A M	
2	Lt Col B 1st Inf Comdg Motor elements 1st Inf 260 vehicles	Area B	A	Area D	10	Close column	19	RJ 520 (IP) CR 515 CR 432 CR 455	12:01 A M 12:20 A M 12:45 A M	12:40 A M 1:10 A M	
3	Lt Col C 1st Engr Bn Comdg Div Tns 1st Engr Bn 1st QM Bn 1st Med Bn 316 vehicles	Area A	A	Area C	10	Close column	23	RJ 411 (IP) RJ 520 CR 455 CR 515	12:30 A M 12:45 A M 1:15 A M	2:25 A M	

OFFICIAL: Y

Lt Col GSC

G-3

Distribution: Same as FO

By command of Maj Gen A
XCol GSC
C of S

■ 131. SHUTTLE MOVEMENTS.—*a. Definition.*—Troop movement by shuttling is a movement by motor in which all or a portion of the trucks make successive trips in moving both cargoes and troops.

b. Time formula.—The following formula is useful for determining the total time of movement of a unit in shuttling:

$$\text{Hours required} = \frac{3 \times \text{distance in miles}}{\text{Speed in miles per hour}} + T$$

(1) The figure 3 indicates the number of trips for each shuttle; for example, one trip to move foot troops, a return trip, and a third with organic cargo.

(2) *T* (a variable), represents the number of hours consumed in unloading and loading personnel and equipment, in turn-arounds at forward and rear assembly areas, and in closing the column into its area of destination. When two routes are available for the movement a value of 3 may be assumed for *T* with a reasonable factor of safety. When more than two routes are available the value of *T* may be reduced.

(3) Speed in miles per hour represents the average speed of the vehicles in the movement.

■ 132. COORDINATION WITH CIVILIAN AUTHORITIES.—*a.* Within continental United States, State Highway Traffic Committees have been formed to provide necessary coordination between the Army and civilian traffic officials, and to facilitate and expedite military motor movements with least possible conflict between military and civilian traffic. Civilian assistance in planning motor movements will be obtained by contacting the "Liaison member, State Highway Traffic Advisory Committee to the War Department" care of State highway police at State capital concerned. In order that intelligent answers to specific questions may be made, and to provide a background for civilian assistance, information shown in the following form should normally be supplied to the committee:

**PLANNING DATA
FOR USE OF
STATE AND MUNICIPAL TRAFFIC OFFICIALS
IN
MILITARY MOVEMENTS**

1. Origin and destination of movement-----
2. Will enter State at ----- on U. S. (State) highway No. -----
3. Desire to leave State at ----- on U. S. (State) highway No. -----
4. Date of arrival ----- Approximate hour of arrival ----- **AM**
----- **PM**
(Indicate Daylight
Saving or Standard Time)
5. Designation of column-----
6. Officer in command-----
7. Personnel strength-----
Military police ---- On solos ----- Side cars ---- $\frac{1}{4}$ -ton trucks

8. Necessary halts.
 - a. Halts -----
(Frequency and duration)
 - b. Noon halt(s) -----
(Duration and other requirements)
 - c. Night halt(s) (water for men, cooking, animals, bathing)

(Area and facilities required)
(latrines; straw) -----
9. Convoy does (does not) have explosives.
10. March characteristics of column:

Serial number	1	2	Etc.	Column summary
Number of vehicles-----				
Gross weight of heaviest vehicle (pounds)-----				
Sketch showing axle loading and spacing of heaviest vehicle-----				
Maximum height of tallest vehicle (feet and inches)-----				
Maximum width of widest vehicle (feet and inches)-----				
Maximum practicable speed under good condi- tions (miles per hour)-----				
Type of march ¹ -----				
Maximum time length (minutes)-----				
Road space at halt (feet)-----				
Maximum road space when moving (feet)-----				

¹ Infiltration, open, or close column.

11. Other data (include any reference to blackout marches)-----

NOTE.--The column commander would appreciate having _____
(Number)

of the latest State Highway maps indicating detours and construction.

INSTRUCTIONS.—Complete in triplicate. Original and one copy for State committee concerned.

b. When and where practicable, this communication with the liaison member of the State committee will be established by personal conference by the commander or his representative. When time will not permit personal conference, liaison will be established by telephone, telegraph, or radio, in which event sufficient information will be furnished to permit the committee to plan intelligently. Initially the liaison member of the State committee will be able to provide the commander with information pertaining to most of the following:

- (1) Most practicable route(s) to be used.
- (2) Alternate route(s).
- (3) Points where it may be advisable to divide column and use two or more routes to alleviate congestion or road wear.
- (4) Time when it is best to pass through areas of traffic congestion or traffic defiles.
- (5) Vehicle spacing and speeds most desirable for coordination with other traffic.
- (6) Location and nature of any unusual road conditions.
- (7) Emergency highway repair work which may be required.
- (8) Required additional information on vehicle weights for investigation of weak bridges.
- (9) Location of facilities for service and supplies.
- (10) State and city police escorts to assist the column.
- (11) Availability of State police communication system for emergency messages including possibility of tuning column radios into police net.
- (12) Location of hospitals available in case of emergency.
- (13) Procurement of dependable road maps.

Whenever unforeseen circumstances dictate a change in the plans for the movement, the civilian agency concerned *will be notified promptly of such change.*

■ 133. FORDABLE DEPTHS OF WATER.—When it is necessary to cross streams, the following figures will be applicable under conditions when moderate current and hard bottom prevail:

<i>Depth in feet</i>	<i>Unit</i>
4 to 6-----	Heavy tanks and tractors.
4 to 5-----	Horse cavalry.
2 to 4-----	Medium tanks and tractors.
3 to 4-----	Infantry.
3-----	Horse-drawn artillery and wagons.
1 to 3-----	Light tanks and tractors.
2-----	Trucks and truck-drawn artillery.

■ 134. CARRYING CAPACITY OF ICE.—The following minimum thicknesses of new sound ice in floating contact with water are required to support loads indicated:

<i>Thickness of ice in inches</i>	<i>Capacity</i>
3-----	Small groups of men.
4 to 5-----	Horse cavalry in small groups.
7-----	Wagons and 75-mm guns.
9 to 12-----	Light tanks (singly).
16-----	12-ton loads.
20-----	20-ton loads.

CHAPTER 5

PROTECTIVE MEASURES

	Paragraphs
SECTION I. General	135-143
II. Antiaircraft defense.....	144-148
III. Antimechanized defense.....	149-153
IV. Protection against chemical agents.....	154-158
V. Handling of explosives and inflammable liquids.....	159-163
VI. Security detachments	164-171

SECTION I

GENERAL

■ 135. SCOPE.—This chapter describes various methods and techniques that may be used to avoid or minimize special hazards affecting motor transport. The general principles only are contained herein; their application in a particular situation will be materially affected by the composition of the motor column, by its mission, and by protective means on hand.

■ 136. DEFENSE OF MOTOR TRANSPORT.—Normally, a troop movement by motor should not be attempted except when the area into which the movement is to be made has already been secured, or when sufficient mechanized vehicles are available to permit the employment of mechanized security detachments capable of clearing the route of minor resistance encountered. Motor transport is particularly vulnerable to enemy attack at locations along the road where congestion is most likely to occur and where traffic density and traffic flow are greatest. Both active and passive defense measures should be utilized at these locations.

■ 137. PROTECTION FOR INDIVIDUALS.—Narrow trenches or individual pits dug in the ground provide cover for personnel against shells, air bombs, or machine-gun fire; if of proper depth and in firm soil these will be passed over by track vehicles without crushing occupants. (See FM 5-15.)

■ 138. CAMOUFLAGE.—*a. General.*—Camouflage can be accomplished by hiding, blending, or deceiving (see FM 5-20).

b. Terminal areas.—(1) Stationary vehicles can best be camouflaged by placing them under natural vegetation in such a way as to break up the regular pattern of shadows produced by vehicles and by covering all parts likely to cast a noticeable reflection of light. When natural concealment is not available, some protection can be obtained by using fish nets or chicken wire properly garnished with artificial garnishing material or natural vegetation. Care must be taken, however, that color and texture blend with the surrounding area.

(2) Strict camouflage discipline must be maintained to prevent the formation of tracks or paths indicating the location of camouflaged vehicles and terminal installations. Existing paths should be wired in to prevent changes that would be readily apparent to enemy observation. Tracks made by the vehicles themselves should be carried beyond the actual location of the vehicle so as not to end abruptly and thus call attention to the presence of the vehicle. Any tendency toward formation of geometric patterns in the parking of vehicles should be avoided. All visible movement must be stopped when enemy aircraft are in the vicinity.

(3) When snow is on the ground, white sheets may be of some value for camouflage purposes. Their use is effective, however, only when strict camouflage discipline is enforced, since wheel tracks, paths, and discoloration show up very readily on snow.

c. Moving vehicles.—Moving vehicles cannot be successfully camouflaged artificially. However, movements may often be routed over roads which are concealed by natural vegetation. If dusty roads are avoided, the chance of the enemy's detecting a motor movement will be minimized. In a stabilized situation, artificial road screens will conceal the nature and extent of road movements from hostile ground or balloon observers.

■ 139. CONTROL OF COMMUNICATIONS.—Enforcement of strict radio silence may often be necessary in order to prevent hostile radio intercept service from locating motor transport movements. Even when strict radio silence is not essential, care should be taken that radios do not provide important information to the enemy. Communication by wire is likewise often subject to enemy interception, especially

when enemy mechanized units are known to be operating in the area. Whether radio or wire communication is used, therefore, it is desirable to set up a prearranged code for use in transmitting information of traffic movements.

■ 140. BLACKOUT RESTRICTIONS.—Restrictions on use of lights are required to provide secrecy and concealment at night. To prevent light from any source being observed, there must be no smoking or lighting of matches during marches made under blackout conditions. Flashlights, headlights, and vehicle parts that might reflect light should be covered. Special blackout lighting equipment has been devised to facilitate movement under these conditions, but in close proximity to the enemy use of any lights whatsoever may be inadvisable. Blackout restrictions are usually covered in the traffic paragraph of the administrative order. They may be repeated in paragraph 3x of the march order.

■ 141. PROTECTION OF PNEUMATIC TIRES.—Enemy efforts to obstruct roads and delay movements of pneumatic-tired vehicles may sometimes include the scattering of broken glass, planks studded with nails, sharp pieces of metal, or specially designed multipronged spikes along the road. Methods of protecting motor transport from such obstructions may include the following:

a. Use of electromagnetic sweepers to clear the road of magnetic materials.

b. Use of mechanical brooms to sweep up both magnetic and nonmagnetic materials.

c. Use of improvised scrapers or sweepers attached at an angle on the front of a truck.

d. Use of "puncture proof" tires with periodic inspections and cleaning of such tires at frequent intervals.

■ 142. PROTECTION FROM MINES.—*a. Detection.*—Antitank and trap mines are likely to be encountered when entering areas recently evacuated by the enemy. Mines can sometimes be discovered from a study of aerial photographs. Spoil from mine burial, patterns of mine fields, tracks, paths, and other signs of activity may help to betray the presence of concealed mines. Electrical or magnetic mine detectors, if available, are useful for locating individual mines. Forks,

sticks, grapnel lines, probes, and similar equipment are used by mine clearing parties (see FM 5-30).

b. Removal.—Engineers and pioneer parties should be specially trained to discover and remove mines from the roadway. Inexperienced personnel who locate a mine should not disturb it except in an emergency, but should post a sentry or sign to warn passing traffic until trained personnel are available to remove the mine or destroy it. Special mine sweepers such as a heavy road roller pushed in front of a tank or other vehicle provide the safest method for destroying antitank mines. Bangalore torpedoes and detonating nets made of detonating cord can be used as a rapid means for clearing a path through mine fields. (See FM 5-30.) Fuzes should be removed immediately from a mine picked up by hand. If impossible to clear the entire road of mines, one lane should be cleared and the other barricaded and well marked. Holes caused by removal of mines should be refilled to restore the road surface to proper condition for vehicular use.

■ 143. **WARNING SIGNALS.**—Aircraft may give warning of impending danger by means of wing signals, flares, dropped messages, or radio. Security detachments may use radio, pyrotechnics, or sound signals. Within the motor column, warning of air or mechanized attack may be given by three long blasts of horn, whistle, siren, or klaxon, repeated several times; or three equally spaced shots with rifle or pistol; or three short bursts of fire from machine gun or submachine gun. An "all clear" signal should be specified to indicate when the danger is over. Only specifically authorized officers in the column initiate the "all clear" signal.

SECTION II

ANTIAIRCRAFT DEFENSE

■ 144. **GENERAL** (see TF 7-109).—Antiaircraft defense of motor transport comprises all measures adopted to prevent or minimize the effects of enemy air operations against motor vehicles and their assigned personnel and cargoes. To achieve maximum results, coordinated and timely use must be made of all measures applicable; and all troops should participate in either a passive or active capacity.

■ 145. AIRCRAFT WARNING SERVICE.—*a. General.*—Speed of air operations makes it imperative that early information be obtained and timely warning given of approach of enemy air forces. Any plan for the defense of motor transport which does not include a suitable warning service is inadequate. The column commander should be directly connected by radio or other means to the aircraft warning service covering the area through which the march is being conducted, and he should be provided with suitable means for alerting various elements of the column. The length of time required for a column to meet an attack varies between wide limits depending on what defense measures are employed. A few seconds warning is sufficient for antiaircraft artillery machine guns mounted in trucks and for other antiaircraft artillery units in position; this warning likewise is sufficient for troops marching in trucks with tarpaulin covers removed. However, at least a minute or more will be required to permit motor transport to clear the road and take cover.

b. Local warning systems.—Local measures for warning of the approach of hostile aircraft may include the use of friendly airplanes, the antiaircraft artillery intelligence service, and the posting of local air guards and air guard observers throughout the moving column (or in terminal areas) and at vantage points to the front, rear, and flanks.

c. Aviation.—Reconnaissance and observation aviation properly employed provide an effective means for discovering and transmitting warning of the approach of hostile aircraft.

d. Antiaircraft artillery intelligence service.—When antiaircraft artillery is employed for protecting critical points on the road net, the antiaircraft artillery intelligence service, in addition to alerting elements of the antiaircraft artillery, can be used to supplement the system of observation designed specifically for the protection of motor columns or terminal areas.

e. Air guards and air guard observers.—Posting of air guards and air guard observers places responsibility for warning on designated individuals whose sole duty is continuous observation. Frequent relief of personnel is essential in order to insure alertness in the performance of this duty. Air guards should be posted to front and rear and on both flanks of the column (or terminal area) and made responsible for observation within a specified sector. If security detach-

ments are used, air guards normally are provided by these detachments. Air guards should be particularly alert to attacks that might come from direction of the sun. In cloudy weather, attacks are most likely to come from fast, low flying, light bombardment planes. By day, air guards should be equipped with dark glasses to permit them to observe for long periods against a bright sky or directly into the sun; night glasses will assist them at night. In order to provide continuous observation, air guards for a moving column move by bounds from one good observation post to another. It is important that air guards be thoroughly trained in recognition of hostile and friendly aircraft (see FM 30-30, 30-34, 30-35, and 30-38), and in maintaining a constant lookout for warning signals transmitted by air guards, by friendly aircraft, or by the antiaircraft artillery intelligence service.

■ 146. PASSIVE DEFENSE.—*a. Concealment.*—Concealment may be used to afford protection from attack by offering a less definitely designated target. Concealment may be obtained by artificial camouflage, use of wooded areas, taking advantage of darkness or weather conditions unfavorable to enemy air operations, use of smoke, employment of blackout lights or extinguishing all lights, and limitations of movement.

b. Dispersion.—Dispersion can be used to reduce vulnerability to air attack by limiting the number of elements which can be damaged by a single bomb or burst of fire. A column moving with extended headways presents an unfavorable target for combat aviation and forces such aviation to make each vehicle an individual target. In planning a march, full utilization should be made of all usable parallel routes so as to obtain the maximum of dispersion, as well as to reduce road time of the march. Within a march column dispersion is obtained by means of infiltration marching (par. 56) or open column marching (par. 58). When open column marching is used, the column commander can control dispersion of the column at will.

c. Deception.—Numerous changes in direction of march, dispatching vehicles in small groups at irregular time intervals and increased distances, mixing of different types of vehicles, and allowing vehicles to pass each other within the column (all of which can be obtained by the use of infiltra-

tion marching) will tend to give an air observer the impression that the target is too transient for attack and deceive him as to the extent of movement. Geometric patterns and uniformity of appearance, either at the halt or while the column is in motion, are quickly noted by air observers, and should be avoided.

d. Speed.—Since it takes an appreciable length of time for observation airplanes to report a column and have attacking airplanes dispatched, a column may often minimize danger of attack by rapid movement. Usually, a column exposed in movement for a period of one hour or less need have little fear of an attack specially organized against it. Attack by transient airplanes already operating in the area, however, may always be expected.

■ 147. ACTIVE ANTI-AIRCRAFT DEFENSE.—*a. General.*—Active anti-aircraft defense includes the employment of ground and vehicular weapons, both by anti-aircraft artillery units and by all troops equipped with small arms weapons, suitable for employment against low-flying aircraft. Pursuit aviation may also be employed as an active defense measure.

b. Motor column.—Strong defense, preferably by anti-aircraft artillery machine guns, should be provided for protection of the head and tail of a column. Other machine guns, automatic rifles, and rifles should be used for protecting interior portions of a column. All weapons should be kept loaded and elevated so as to be ready for immediate use. Truck covers should be removed from trucks transporting personnel (except when the column may expect to be attacked with chemical agents) (see par. 157), to facilitate firing at airplane targets. Whenever terrain and roads permit, detachments armed with weapons capable of delivering anti-aircraft fire should march parallel to columns.

c. Critical locations.—Thirty-seven millimeter anti-aircraft guns, and guns of larger caliber on present mounts, are not suitable for protecting motor columns when moving as part of the column. Such guns should take positions at traffic bottlenecks and other critical points along the route of march prior to arrival of the main body of the column. Anti-aircraft artillery should be made available at important terminal areas.

■ 148. PROCEDURE IN CASE OF AIR ATTACK WHILE ON MARCH.—In case of an air attack by day or night on a moving column, the

column commander must make the decision as to whether the column should continue the march or halt. In general, the motorized elements should clear the center of the road, halt, dismount, take cover, and bring all suitable weapons to bear on the attacking aircraft. If the situation demands continued movement in order to arrive at destination at appointed time, maximum advantage is taken of dispersion; elements other than troops manning antiaircraft guns take any cover afforded by the vehicles while in motion.

SECTION III

ANTIMECHANIZED DEFENSE

■ 149. DEFINITION (see FM 100-5 and TF 5-146).—Anti-mechanized defense of motor transport embraces all measures for security and defense of a moving column or terminal area against hostile mechanized or armored units.

■ 150. BARRIERS AND OBSTACLES (see FM 5-30 and TF 5-145, 5-146, 5-147, 5-148, and 5-149).—*a. General.*—Obstacles include both natural terrain features and artificial works of construction or demolition, other than fire power, that may impede enemy mechanized units. The term "barrier" is applied to a group of obstacles used to block an area. *Barriers and obstacles are of value only so long as they are covered by fire sufficient to prevent removal or neutralization.* Barrier detachments are security units charged with the erection of barriers and their protection by fire. Obstacles used for road blocks preferably should be placed so that enemy vehicles will come upon them unexpectedly and not be able to stop or turn in time to avoid them. *Road blocks should always be placed in a defile so as to prevent a detour being made more easily or quickly than reduction of the obstacle.* Barriers and obstacles when placed so they cannot easily be bypassed and when covered with fire of all available weapons, provide surest defense against mechanized attack.

b. Antitank mines.—The antitank mine (see fig. 19) is the most effective quick obstacle for general use under field service conditions.

Mines disable and stop vehicles by damaging their wheels or tracks. To preserve surprise, mines should be concealed. However, adequate numbers of unconcealed mines properly

covered by fire will block mechanized vehicles. Dummy mines may be used to delay and deceive the enemy as to location of real mine fields. Antitank weapons are needed to destroy mechanized vehicles that have been disabled and slowed down by mine fields. Antitank mines are generally laid in a band of from 3 to 6 rows, with a distance between rows of from 1 to 3 yards. (See fig. 20.) The least density of mines in one band, considering all rows, should be about $1\frac{1}{2}$ mines per yard of front. For increased protection, it is preferable to lay

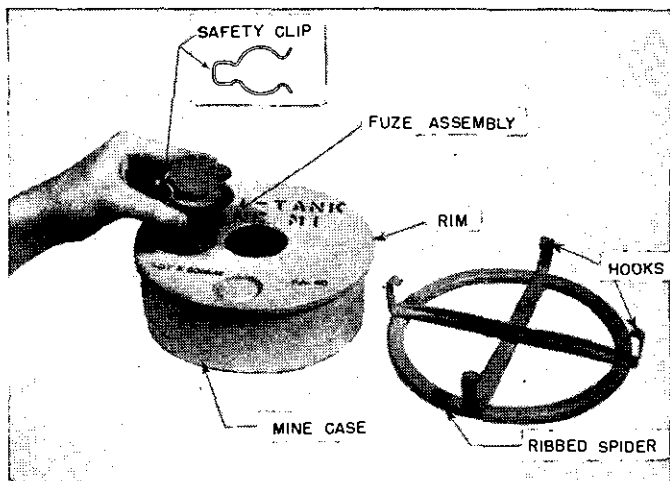

FIGURE 19.—Antitank mine.

additional bands 20 to 30 yards in rear rather than to thicken a single band.

c. Wire rolls.—Wire rolls (see FM 5-30) use a No. 11 oil-tempered steel wire wound in a continuous spiral about 4 feet in diameter, with spirals connected at points around the circumference by strong clips. When extended, these rolls are about 40 feet long and are anchored lightly to the ground by small metal pins. (See fig. 21.) If not damaged by vehicles, wire rolls may be collapsed and easily transported to another location. Each roll weighs approximately 40 pounds, and about 100 can be transported in a $2\frac{1}{2}$ -ton truck. Effective wire rolls are difficult to improvise in the field because

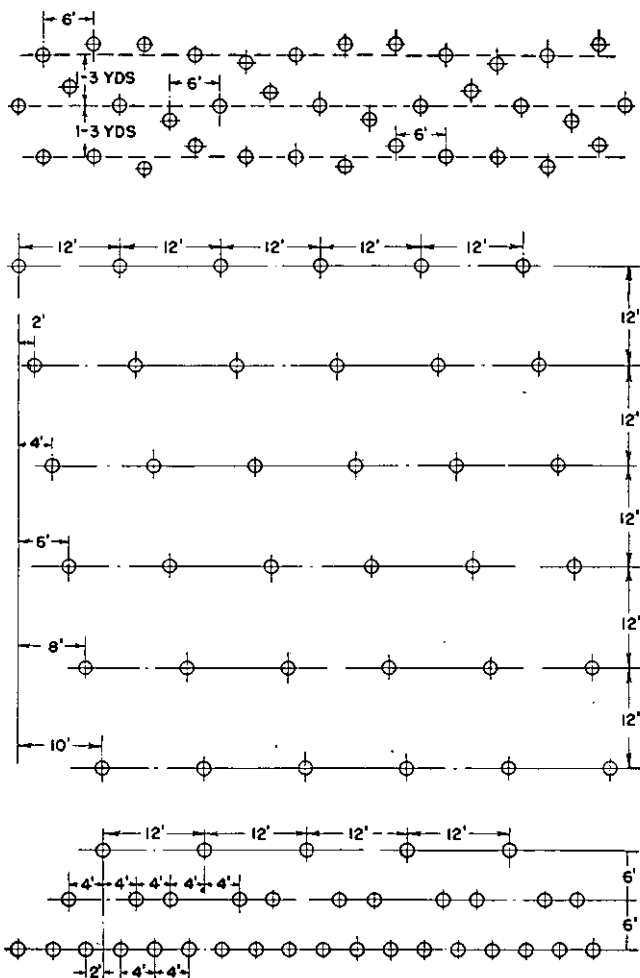

FIGURE 20.—Methods of arranging band of antitank mines.

of the strong clips required. To establish a wire roll obstacle group, four rolls should be extended across the roadway and located with each roll in contact with the adjacent roll. The ends should be pinned down. The first roll of the group

should be suspended so that the bottom of the roll is about 6 inches above the road surface. Logs, 8 to 10 feet long and about 5 inches in diameter, should be placed in one or two of the three rear rolls. The wire roll obstacle should be established in groups of two and spaced about 40 to 50 yards apart. Wire rolls are effective against wheeled vehicles but are not an obstacle against track-laying vehicles.

d. Demolitions.—A most effective way to deny a road to enemy mechanized units is to demolish its bridges. This is often done with explosives (see FM 5-25), although wrecking bridges by pulling them down with vehicles and cables or by use of wrecking tools may be just as quick and effective; wooden bridges can be destroyed by pouring gasoline

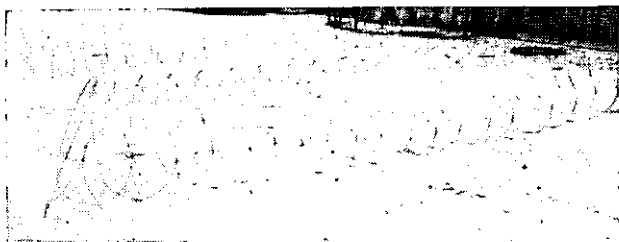

FIGURE 21.—Wire roll.

on them and setting them afire. Frequently, it may be possible to block a road by use of explosives at a deep cut, or high fill, by demolishing a tunnel, or by dropping an overpass structure down on the road.

e. Inundation.—Flooding of ground to a depth of 4 or more feet by construction of a dam or by cutting a levee will provide a serious obstacle to wheeled vehicles and light and medium tanks. However, flooding is not effective against amphibians.

f. Parked vehicles.—In an emergency, vehicles may be parked across a road defile so as to block it temporarily, after removing wheels or tracks to prevent towing.

g. Reducing road friction.—Oil, soap, or other slippery materials placed on sharp curves, at well chosen locations, may cause enemy vehicles to skid off the road and overturn. This means may also be used to reduce traction on a steep grade so as to make it impassable to enemy vehicles. In

below freezing weather, water poured on a road will turn to ice and accomplish the same results.

h. Puncture producing materials.—The strewing of broken glass, nails, sharp pieces of metal, or specially designed multi-pronged spikes may cause delays to enemy vehicles equipped with pneumatic tires.

i. Chemical mines.—Chemical mines may be used alone or in combination with other obstacles to block a road or other location providing an approach for mechanized vehicles. They are most effective in low places and in thick vegetation. Standard mines weigh about 12 pounds each and are packed 6 in a box crate weighing about 90 pounds in all. These mines can either be fired with a nonelectric cap and time fuze, or by electric caps and magneto exploders. Each mine contaminates an area 20 to 25 yards in diameter. To contaminate roads, chemical mines are staggered at intervals of 17 yards on each side of the road using about 200 mines for one mile of road. To contaminate demolitions or other obstacle sites, one or more mines should be fired either with or subsequent to the demolition or construction of the obstacle, so as to drench the area where work of repair or removal will have to be done.

■ 151. WEAPONS.—Antimechanized weapons include antitank guns, antitank machine guns, small arms, antiaircraft guns, field artillery, combat aviation, armored vehicles, rifle grenades, hand grenades, gasoline bombs and flame throwers.

a. Guns and small arms.—The effectiveness of fire on mechanized vehicles will vary with angle of impact, thickness of armor, material of which the armor is composed, type of vehicle (open or closed), and the caliber and ballistic properties of weapon. In general, it may be assumed that small arms, requiring drivers to keep their ports closed, will penetrate light armor at a range of 200 yards and may damage more heavily armored vehicles by hits on vulnerable parts. The present 37-mm antitank gun is able to penetrate the armor on light tanks at 1,000 yards and will damage most medium tanks at that or somewhat shorter ranges.

b. Combat aviation.—In case of a surprise attack, combat aviation may be the only combat force immediately available to divert or delay a hostile mechanized unit. Combat aviation depends primarily on bombing for its effect against mechanized vehicles.

c. *Armored vehicles.*—Armored vehicles may function as mobile antitank guns in defense of motor transport.

d. *Grenades.*—Hand grenades (particularly thermite grenades) and sticks or blocks of explosives may be effectively employed against mechanized units if dropped from above, or thrown and exploded under vehicles.

e. *Gasoline bombs.*—This type of bomb can be improvised by using glass bottles, gasoline, and rags. A glass bottle, preferably a quart size, is filled with gasoline or other inflammable liquid, and the stopper is securely attached. Around its base a gasoline soaked rag or other such material is fastened. This rag is ignited just before the bottle is thrown. On striking a vehicle the bottle shatters and the gasoline spreads out and burns. Greater effect is produced by using larger bottles, or cases of such bottles, and dropping them on the vehicle from above.

f. *Flame throwers.*—Flame throwers can be used against the ports of mechanized vehicles and will prevent the effective use of weapons carried by such vehicles.

■ 152. *SECURITY.*—a. *Security elements.*—Security elements for antimechanized defense may include aircraft, armored vehicles, cavalry, or motorized security detachments.

b. *Column formation.*—A column moving at extended distances (using infiltration or open column formation) is less vulnerable to mechanized attack than is a compact closed-up column.

c. *Disposition of weapons.*—Antimechanized weapons should be spread throughout the column, with a heavy concentration of weapons in the advance and rear guards. If one or both flanks are exposed, heavy concentrations of anti-mechanized weapons should also be allotted to flank guards.

d. *Selection of route.*—Careful planning will often permit the column commander to select a route limited by natural features to a few avenues of hostile approach. In this event, a high degree of security may be obtained by proper use of barriers and obstacles. Halt locations should be selected so as to make full use of terrain lines, or natural features which restrict the operation of mechanized vehicles, and security detachments should habitually be disposed in positions of readiness.

■ 153. PROCEDURE ON MAKING CONTACT WITH HOSTILE MECHANIZED UNITS.—Actions of a column commander on making contact with hostile mechanized units will depend upon his estimate of the situation. In general he has a choice between two courses of procedure:

a. Utilization of speed of column to outdistance mechanized force.—When an alternate route is available, the column commander may divert the column to such route at the first warning of a mechanized attack. If the attack comes from the front, the entire column may reverse direction simultaneously, dispatch a barrier detachment to cover its withdrawal, and proceed to the rear until a suitable detour road to the flank can be found. A motor column attacked from the flank can best protect itself by dispersion. In this case, vehicles at the point of attack transmit the specified warning signal, disperse and engage the hostile troops with all available means and weapons; vehicles ahead of the point of attack continue the march at increased speed; and vehicles behind the point of attack make a rapid detour to the rear. Barrier detachments are dispatched, if practicable, from each group of vehicles at the earliest opportunity to block roads to their rear. At the end of the attack all vehicles assemble at the next scheduled halt location. Smoke may sometimes be used to confuse attacking hostile mechanized units while the column is making good its withdrawal.

b. Active resistance.—A motor column having sufficient combat power to warrant a stand against a mechanized threat should prepare for active resistance. In this case, at the first warning of the attack, the column halts, all vehicles clear the road, troops detruck and dig in, barriers are erected, and antimechanized weapons are placed in concealed positions to cover the terrain over which the mechanized unit must advance.

SECTION IV

PROTECTION AGAINST CHEMICAL AGENTS

■ 154. GENERAL.—This section summarizes the most important measures that may be used for protection of motor transport against chemical agents. Details of defense against chemical attack are included in FM 21-40.

■ 155. INTELLIGENCE.—Advance information as to enemy capabilities as regards the use of chemical agents is provided by regular intelligence agencies in the same manner as any other information of the enemy.

■ 156. RECONNAISSANCE.—*a. Distant reconnaissance.*—Distant reconnaissance by air or other means should determine the enemy's immediate preparations for chemical operation, both offensive and defensive. This reconnaissance may provide specific information, such as the installation or storage of chemical mines, cylinders, projectors, etc.

b. Close reconnaissance.—When enemy capabilities include use of chemical agents, particular attention must be paid to selection of routes and terminals which are least favorable to enemy chemical attack. When practicable, reconnaissance should be made in the daytime, since it is extremely difficult to determine the exact extent of contaminated areas at night. If a contaminated area is found, the following information should be obtained:

Exact location and extent of area.

Kind of gas and concentration, heavy, medium, or low.

Availability of routes leading around area on upwind side.

Necessity of wearing gas masks while traversing area.

When no detour is available, estimate of time, labor, and materials required for decontamination.

■ 157. PROTECTION AGAINST CHEMICAL ATTACK.—*a. Methods of attack.*—Chemical attack against motor transport will usually be in the form of chemical bombs or spray attacks from the air or in the form of chemical shells fired from artillery or from chemical mortars. The agents most likely to be carried in small bombs or shells are persistent agents and white phosphorus. Large bombs or shells may discharge either persistent or nonpersistent gas. Spray attacks may involve the use of mustard, lewisite, or any type of liquid smoke. One airplane can cover an area approximately 800 yards long and 300 yards wide. Obstacles may be contaminated by static chemical mines, thus endangering any person attempting to clear the road.

b. Protection against air attack.—In general, measures used for protection of motor transport against chemical attack

from the air are the same as those applicable to other forms of air attack (see pars. 144 to 148 incl.). As a means of protection from vesicant action of liquid, mustard or lewisite, however, all tarpaulins should be tightly closed, vehicle windows should be rolled up and on open cars side curtains should be installed. This will materially lessen the extent to which fire power from the column may be used against attacking aircraft, but is nevertheless necessary when spray attacks may be expected. Gas masks should be put on at first warning of attack, and every effort made to prevent the body from coming in direct contact with drops of mustard or lewisite. Personnel operating anti-aircraft weapons and others in exposed positions should wear protective clothing. When protective clothing is not available, raincoats will provide limited protection. That part of a moving column affected by a chemical attack from the air should normally continue to march while the attack is in progress and move out of the contaminated area as rapidly as possible. Elements of the column in rear of the contaminated area should bypass it on the upwind side or should reverse direction and make a wider detour by using the first available side road. If detour of contaminated area is impracticable, the column may pass through it under conditions outlined in FM 21-40.

c. Protection against chemical shells.—The range of chemical shells is so limited as to make it improbable that motor transport would be subjected to an extensive chemical attack by this means. However, if so attacked, procedures would be essentially those indicated for air attacks in *b* above.

d. Procedure in passing contaminated road block.—If a contaminated obstacle is encountered, an uncontaminated way around is sought. In case the road block has been located in such a manner that no alternate routes are possible, the contaminated debris and surroundings must be removed and destroyed, or otherwise made safe. Personnel engaged in opening up or clearing contaminated obstacles will wear protective clothing, and gas masks and all tools and equipment used in work will be decontaminated afterwards.

e. Procedure after attack.—After attack, the column re-assembles outside the contaminated area and engages in the following:

(1) *First aid and evacuation.*—Affected individuals will be given first aid and all casualties evacuated. All contaminated clothing shall be removed, piled, and marked for later salvage, care being taken that contact with, or vapor from, does not endanger other personnel.

(2) *Reconnaissance.*—Since an area contaminated as a result of a chemical attack involving persistent gases will be dangerous for some time, the extent of the area should be determined and a full report of the attack should be made to higher headquarters. Signs should be posted to indicate extent of contamination and available detours (see par. 117).

(3) *Preliminary to decontamination.*—The commander of any motor vehicle, train, convoy or other motorized element which has encountered a contaminated area, or which has suffered a direct chemical attack will, as soon as possible thereafter, make an inspection of the vehicles in his command to determine the following:

(a) Whether or not decontamination of the vehicles is necessary;

(b) If so, the priority of decontamination operations.

■ 158. DECONTAMINATION.—After a chemical attack, decontamination by various agencies may be required.

a. *Decontamination of equipment and vehicles.*—Decontamination of the motorized element and its equipment is the responsibility of the commander thereof. Each vehicle is equipped with a 1½ quart decontaminating apparatus which is furnished for emergency purposes. If more thorough decontamination is necessary, methods, materials and equipment as outlined in FM 21-40 and TM 3-220 will be employed.

b. *Decontamination of areas and roads.*—When a road or area must be decontaminated to permit safe passage of a convoy, the commander thereof is responsible for its decontamination. Special chemical troops may be used for this work. However, in case no troops are available, the operation must be carried out by such troops as can be had for the job. Procedures, materials, organization, and other pertinent information is contained in FM 21-40 and TM 3-220.

SECTION V

HANDLING OF EXPLOSIVES AND INFLAMMABLE LIQUIDS

■ 159. DISPERSION.—Explosives and inflammable liquids (see FM 5-25 and TM 9-2900) should be stored, handled, and transported in small units; individual units should be sufficiently separated from each other to prevent an explosion or a fire involving one from exploding or burning another. This is particularly important when it is necessary to transport explosives and inflammable liquids over important bridges or through congested areas, tunnels, or other particularly vulnerable locations.

■ 160. SEGREGATION OF CAPS.—Detonating caps should never be transported in a vehicle carrying other explosives or inflammable materials. Mines, grenades, and demolition explosives should not be fuzed until they are ready to be used, and fuzes should be removed before the explosive materials are transported to a new location.

■ 161. PROTECTION FROM SPARKS AND FIRES.—*a. Static electricity.*—Ground conductors should be provided to neutralize charges of static electricity prior to and during transfer of inflammable liquids.

(1) Drag chains for this purpose should be attached to the body of tank trucks or other vehicles used for transporting such liquids. These chains, to be effective, must provide a continuous metallic contact from the container carrying the liquid to the surface of the road. For this purpose, about 4 inches of chain should be in contact with the roadway. A 4-inch or 6-inch length of large (6-inch) pipe rolling in contact with the road on the axis of a smaller (1-inch) pipe suspended by two chains from the truck body, can also be used.

(2) When transferring inflammable liquids from one container to another, the two containers should be bonded by an electric conductor. Such bonding can be made by touching the metal of the two containers together. In fueling vehicles from drums or cans the flexible nozzle of the can must be brought into solid contact with the filler opening. When filling drums or vehicles from a hose of a dispenser, the nozzle must always be brought solidly against the metal of the

drum or tank. Special bonding arrangements may be needed in filling tank trucks.

b. Exhaust gases and ignition sparks.—As a precaution against accidental fire or explosion caused by hot exhaust gases or sparks from a vehicle ignition system, vehicle engines should be turned off when loading explosives or inflammable liquids.

c. Sparks from metal.—To avoid the possibility of sparks, nonmetallic tools should be used for handling explosives or inflammable liquids. The interior of truck bodies used for transporting explosives and inflammable liquids should be lined with wood or other nonsparking material.

d. Open flames and coals.—Smoking and unnecessary lighting of matches should be absolutely prohibited when in the vicinity of explosives or inflammable liquids, particularly when such materials are being loaded or unloaded. Only electric lights should be used for illumination. Inflammables and explosives carried in open trucks should be well covered with a tarpaulin as a means of protecting the load from cigarettes carelessly thrown from other vehicles. Vehicles carrying explosives or inflammables should always maintain a safe distance from open fires.

e. Fire fighting equipment.—Large size fire extinguishers should be carried by vehicles transporting inflammable or explosive materials. In areas where considerable quantities of such materials are being handled, special apparatus for fighting large scale fires should be available.

■ 162. GENTLE HANDLING.—Great care must be exercised to avoid unnecessary jar or shock in the handling of explosives. This is particularly essential in carrying sensitive explosives used in detonators. Containers packed with explosives should never be rolled, thrown, or dropped while being handled. All reasonable precautions, including placing the vehicle in gear, setting the hand brake, and blocking wheels, should be taken to prevent accidental movement of vehicles when they are parked. Explosive materials should be securely loaded inside the vehicle in which they are being transported so as to eliminate any possibility of shifting or falling out. Explosives should never be carried on a tail gate or on the outside of a truck body. Unless there is a need for secrecy, vehicles carrying explosives should be clearly identified. Whenever they

halt on the road, guards or signs should be conspicuously posted to warn approaching traffic of the special danger of collision. Speeds of such vehicles should be moderate to avoid unnecessary jars to loads and to minimize possibility of collision with other vehicles.

■ 163. LEAKAGE OF INFLAMMABLE LIQUIDS.—If a vehicle transporting inflammable liquids develops leakage en route, as a result of collision or other cause, further movement of the vehicle should be limited to the minimum distance necessary to dispose of the load safely. When leakage is of such character that further transportation is unsafe, the vehicle should immediately move off the traveled portion of the road. Trenches may be dug to prevent the liquid being spread over a wide area. If possible, the liquid should be kept away from streams and sewers. Congregation of spectators should be avoided, and smoking or lighting of fires in the vicinity must be prevented. Guards or markers should be posted to outline the area involved and to warn all concerned against the danger of sparks, open flames, or smoking. (For detailed safety rules see app. V.)

SECTION VI

SECURITY DETACHMENTS

■ 164. GENERAL.—When security detachments are detailed from a motor column, these detachments, in addition to providing tactical security, may also be called upon to perform other duties (see FM 100-5 and 17-10).

■ 165. TYPES.—Security detachments dispatched from a motor column may include advance reconnaissance patrols, an advance guard, flank guards, and a rear guard. Motor transport terminal areas are protected by an outpost.

■ 166. ECONOMY OF FORCE.—Duty on reconnaissance and security missions is very tiring. In order that troops may be prepared to perform their primary missions, they must be given every opportunity to rest. Security detachments, therefore, should be no stronger than necessary. *Promptness and speed will frequently contribute more to safety of a moving column than deliberate and detailed security measures.*

■ 167. ADVANCE RECONNAISSANCE PATROLS.—*a. General.*—Advance reconnaissance in the direction of march is provided

for by small patrols (moving in mechanized vehicles if these are available) which operate well ahead of the column and cover the main routes and important intersecting routes in the direction of march. Each patrol should have at least two vehicles in addition to any vehicles required for messengers. The number of patrols varies with the situation and road net. If marches are not in immediate presence of the enemy, these patrols can be reduced to one or two. When contact with hostile elements becomes imminent the number of patrols should be increased. Advance reconnaissance patrols normally should precede the head of the first march unit by 30 minutes or more. Advance patrols ordinarily operate under a reconnaissance commander. The message center vehicle of this commander should habitually march on the route to be followed by the main part of the column. The advance guard may be made responsible for sending out advance patrols when its strength and composition are appropriate.

b. Conduct of reconnaissance patrols.—The principal mission of advance tactical reconnaissance is to locate hostile elements in the direction of march and to give the column commander timely information of their location, strength, composition, and movement. One vehicle in each patrol should be used for "get-away" in case the patrol is surprised. This vehicle should march well to the rear of the rest of the patrol. Messages between patrol and reconnaissance commanders are sent by the "get-away" vehicle when radio communication cannot be used. Patrols no longer able to advance report contact with the enemy, conceal their vehicles, take cover, and remain in observation. If their mission requires it, such patrols may put out road blocks or otherwise take steps to delay the enemy. Reconnaissance of alternate routes should also be made.

c. Indications of hostile movement.—Reconnaissance patrols should be constantly alert to any evidence of the presence of hostile forces. They should look for indications of hostile movement, such as—

(1) Direction of hostile movement shown by wheel tracks on gravel and dirt roads, particularly at road intersections, and by wheel tracks on shoulders of paved roads where troops have halted or where traffic has left the road to move cross country.

(2) Trash or debris along the road giving evidence of extent and nature of enemy movement.

(3) Dust created in dry weather by truck columns moving over dirt or gravel roads.

(4) Fields and meadows showing signs of use as bivouac sites.

(5) Woods and brush giving evidence of use for camouflage purposes.

(6) Marks of urination visible on dry ground or in snow where columns have halted, which may indicate both length of halted column and number of personnel.

(7) Silhouette of hostile troops moving in the distance against the skyline in rough or rolling country.

(8) Sound of columns, particularly when such columns include track vehicles.

■ 168. ADVANCE GUARD.—*a. Composition and formation.*—

The advance guard precedes the first march unit of a motor column by from 5 to 15 minutes. This time distance must be increased when the terrain is open and where contact with enemy is probable. The advance guard usually consists of a point, an advance party, support, and reserve. The point precedes the advance party by from 2 to 5 minutes. A point should consist of at least four vehicles, two of which should be motorcycles. Scout cars are used if available. Due to the danger of ambush, no more men than are needed to observe should be included in the point. The point should move by bounds when contact with the enemy is probable. The advance party, which consists of three or more vehicles marching in open column, usually follows the point. The support follows several minutes behind the advance party. When necessary, the advance guard is reinforced by the leading march unit of the column. If this is done, the senior commander present assumes command of the combined forces. The rear vehicle of each element of the advance guard is designated as a "get-away" vehicle. Provision should be made to include antitank mines in the advance guard. Antitank and antiaircraft guns, if available, are distributed in the advance guard. These guns are disposed for fire when danger of air or mechanized attack is imminent.

b. Duties.—The advance guard protects the column from the front and facilitates its march. It observes the route of

march and intersecting roads for indications of hostile movement (see par. 167). It drives off small hostile elements, and develops, and delays strong hostile forces without committing the column to a general engagement. It keeps the column commander completely informed of the situation to the front and adopts a formation which will facilitate escape of at least one vehicle in case of surprise.

c. *Procedure when attacked.*—When the point discovers the enemy it immediately repeats the specified warning signal, then does everything possible to delay the enemy (including blocking the road and laying out antitank mines). If other means of communication cannot be used, the "get-away" vehicle of the point proceeds to the rear to carry information of the attack to the advance party. The remainder of the advance guard relays the warning signal to the head of the main column, halts, and detrucks. All but two or three vehicles reverse direction and take cover to the rear. The two or three remaining vehicles are turned sideways on the road to form a temporary road block, and a band of antitank mines is laid across the road in front of these trucks. The advance guard then, utilizing available terrain to best possible advantage, takes prompt and aggressive action to develop the situation. If the enemy is weak, the advance guard pushes him back or destroys him. If enemy in force is encountered, the advance guard seizes the best available terrain from which to cover the development of the main body.

■ 169. FLANK GUARDS.—a. *General.*—Flank protection is provided by covering detachments which successively occupy key positions on the exposed flank or flanks of a march column. The interval between the column and its outer flank detachments varies with the terrain and road net, but in open country this interval should be from 5 to 10 miles. At night, and in close country, this interval may be reduced. All detachments operating on one flank of a column should be under the command of a flank guard commander, who normally marches on a designated flank route. Flank detachments vary in size from reconnaissance patrols to detachments of size and composition similar to advance guards.

b. *Operation.*—The mission of a flank guard is to give warning of hostile activity to its flank and to delay enemy attacks long enough to permit the column to proceed unin-

errupted. Flank reconnaissance patrols fight only when this is necessary to accomplishment of their mission. Heavy flank guards march in approximately the same formation as an advance guard, except that where the road net permits they maintain a patrol on the outer flank in addition to a point in front. When attacked, the flank guard acts in a manner similar to an advance guard. Usually, however, it cannot expect to be reinforced by detachments from the main column. Flank guards attacked by strong enemy forces will frequently have trouble in regaining their position on the flank of a column. In this event, they should notify the main column so they can be replaced by new detachments.

c. Rate of march.—The flank guard must regulate its movement so as to provide continuous security for the flank of the column. Often, it will be necessary to move out far in advance of the column in order to establish detachments at key terrain features in time to cover the main column. Normally it will proceed by bounds so as to cover successively, important avenues of hostile approach. Changes in general direction of march of the main column will often require that new flank guards be constituted from the advance guard, the old flank guard being given a new mission. The flank guard commander, therefore, should know the time length of the column and the time at which it is scheduled to arrive at specified points on the route of march. In addition, the progress of the main column should be checked at frequent intervals.

■ 170. REAR GUARD.—The rear guard is similar in organization and operation to the advance guard. The mission of the rear guard is to protect the rear of the main column from molestation by hostile forces which have swifter marching rates than the column. It is not normally reinforced from the main body. In case of a withdrawal movement, the rear guard may be required to execute demolitions prepared by detachments from the main column. When attacked, the rear guard makes dispositions similar to those of the advance guard (see par. 168), except that its trucks normally stay closer to personnel so as to enable them to get away quickly when necessary. After disengaging from the enemy, the rear guard entrucks as rapidly as possible and resumes its former position in the march column.

■ 171. **OUTPOSTS.**—The outpost organized for protection of a motor transport terminal area is similar to that used by any military command (see FM 100-5). Until such outpost is organized, however, advance, flank, and rear guards of a column establish outguards outside the boundaries of the terminal area. These outguards cover main routes of hostile approach to the area. They lay mine fields or construct temporary road blocks on these routes of approach, but they do not execute demolitions or construct road blocks of a permanent nature unless specifically ordered to do so. Vehicles in the terminal area are parked in a dispersed formation and are concealed or camouflaged to the greatest practicable extent. Local protection of vehicles is provided for by sentinels detailed from among the drivers.

CHAPTER 6

PIONEER WORK, FIELD EXPEDIENTS, AND DIFFICULT OPERATIONS

	Paragraphs
SECTION I. Pioneer parties.....	172-174
II. Field expedients.....	175-186
III. Difficult operations.....	187-203

SECTION I

PIONEER PARTIES

■ 172. MISSION.—The mission of a pioneer party is to execute rough, hasty tasks of construction or demolition, to facilitate movement of our troops and impede the movement of hostile troops. This work is ordinarily determined by route reconnaissance (see sec. III, ch. 4).

■ 173. EQUIPMENT.—Personnel and equipment for pioneer parties are based on an estimate of road work that will be required.

a. Military vehicles which may operate across country should carry pioneer tools and equipment to assist in crossing difficult terrain. These will vary according to Tables of Basic Allowances. If possible, a winch equipped vehicle should accompany each cross-country group. In general, allowances will permit the following equipment per vehicle:

- 1 jack
- 1 pick
- 1 shovel
- 1 tow chain or cable
- 1 tow rope
- 1 ax
- 1 set antiskid chains
- 1 set strap-on emergency chains

b. One or more vehicles in a march unit should carry additional equipment for the pioneer party. The following will serve as a guide for loading a truck to accompany a pioneer party:

- 1 set, vehicle tools
 - 1 winch, if available, with 300 feet of cable
 - 1 block and tackle (with 300 feet 1-inch rope) (if winch is not available)
 - 2 pieces tow rope, 1-inch, 150 feet long
 - 1 $\frac{3}{8}$ -inch or larger cable 300 feet long (if winch is not available)
 - 2 towing bars, universal
 - 1 jack (in addition to the one assigned to the vehicle)
 - 2 planks for jack bases, 2' by 12' by 2'
 - 2 shovels
 - 2 wire cutters
 - 1 pick
 - 2 axes
 - 2 sledges
 - 2 crowbars
 - 1 rectangular timber about 4' by 6' by 6', railroad tie, steel rail, or I-beam (suitable for deadman or wheel block)
 - 1 keg of nails, 60d
 - 300 feet 12-gage wire
 - 2 hammers, claw
 - 1 saw, crosscut, 2-man
 - 2 saws, hand, crosscut
 - 2 tow chains (each about 15 feet long)
 - 4 I-beams or channels heavy enough to carry the heaviest loaded vehicle over an 8-foot span, or sufficient timbers for the same purpose
 - 4 wheel mats, canvas or braided rope, 3' x 6'
 - 1,000 sandbags
 - 1 roll of heavy chicken wire
 - 1 roll of burlap
 - 500 pounds decontaminating material
 - 1 apparatus, demustardizing
 - 1 squad set, engineer demolition equipment
- (See Corps of Engineers Supply Catalog, Part II, 1942.)

c. Pioneer tools for individual trucks should be carried so as to be readily available for use without unloading the vehicle. These tools are mounted in a tool bracket fastened to vehicles as specified in Quartermaster Corps Motor Trans-

port Technical Service Bulletin No. X-7, August 27, 1940 (Recommended Mounting for Pioneer Tool Brackets).

■ 174. DUTIES.—The principal operations performed by a pioneer party are as follows:

a. Obstacles such as rocks, logs, stumps, trees, and holes which cannot be detoured are eliminated. Buried mines are detected and removed (par. 142).

b. Soft surfaces such as sand, marshes, or loose soil are strengthened by covering with sandbags, logs, planks, brush, small rock, wheel mats, cornstalks, hay, or like materials. Sand may be covered with chicken netting or burlap.

c. Ice-covered winter roads are covered with sand, dirt, or cinders where slippery or dangerous.

d. Ravines and ditches are made passable by breaking down steep banks sufficiently so that running boards, lower parts of the chassis, overhanging front or rear portion of the body, or the spade of a towed gun trail will not be suspended. When wet, the bottoms of ditches are strengthened to withstand the wheel impact and traction effort of heavy vehicles. Logs, rocks, brush, sandbags, etc., are used to fill in; planks or logs are used for bridging purposes. These and similar materials are secured by staking down, wiring, weighting with rocks, etc., so that they will not be displaced.

e. Shallow stream crossings with good approaches and solid bottoms are chosen. Steep approaches are cleared straight down so that there will be no danger of side slipping. Traction should be increased when banks are soft or slippery. If this cannot be done sufficiently with brush, hay, etc., ramps may be covered with poles, corduroy or planking. Loose dirt is never added on slippery approaches, in holes, or on steep ascents, because it reduces traction. However, sand may be added to wet clay approaches to increase traction. Rocky creek bottoms are checked carefully for dangerous obstructions. If there are holes or if the bottom is soft, rocks, brush in fascines, or logs are used to fill such holes and prevent vehicles becoming mired. The passage across a stream is plainly marked, indicating, when pertinent, strength of current, width, and depth.

f. On steep ascents or descents or where a deep crossing is required, a winch or tackle is placed in position.

g. Bridges which are found to be weak (par. 94) are usually strengthened by the addition of a bent, a single support (where one beam only is weak), or stringers. Where there is danger of loads breaking through the flooring, additional planks are laid along the wheel tracks to distribute the load. Joints are staggered and planks are nailed down. Wheel guards of heavy timbers, ties, or poles are secured near the safe edge of the bridge to prevent vehicles from running off (fig. 22). (See FM 5-10 or 5-35.)

h. Rafts are usually built for crossing unfordable waters where bridges, engineer equipment, or commercial ferries are not available. (See TF 7-20 and FM 5-10.) Simple rafts large enough to ferry trucks and their towed loads can be built from boats, oil drums, logs, and timbers. Twenty-five 50-gallon drums floated between the cross timbers of a platform will give a capacity of about 10,000 pounds. Care must be taken that the drums are sealed. If a rope or cable is stretched across the water, a raft may be attached thereto and operated as a rope (cable) ferry. Propulsion of a rope ferry is by man power or winches on the two shores. The rate of crossing may be greatly increased by towing the ferry, using the cable only as a guide. Trail or flying ferries (fig. 23) may be used to cross flowing streams when the current is as great as 3 feet per second. Trucks may be placed on paulins, wrapped up with load, pushed in, and floated over. On grounding, paulins are released, and trucks driven or "winched" out.

i. A barbed wire entanglement that blocks a road can be removed by cutting it on each side of the road, attaching a tow chain or rope to the section, and pulling the section out with a truck.

j. Sections of road and bridges which have been sprayed with persistent chemical agents are decontaminated (par. 158). Where decontamination is not immediately practicable, detours are selected.

k. Paths are cleared and marked through land mine areas, or detours are selected. (See par. 142.)

l. In a withdrawal operation obstacles are placed to delay the enemy. (See FM 5-25 and 5-30.)

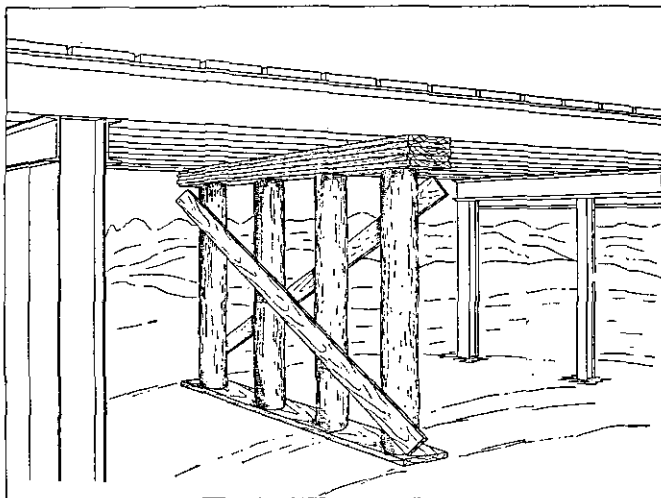

① Bent.

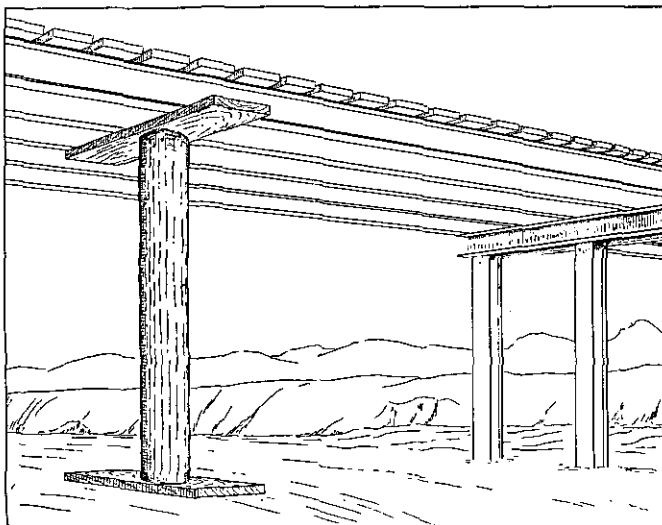

② Single support.

FIGURE 22.—Reinforcing bridges.

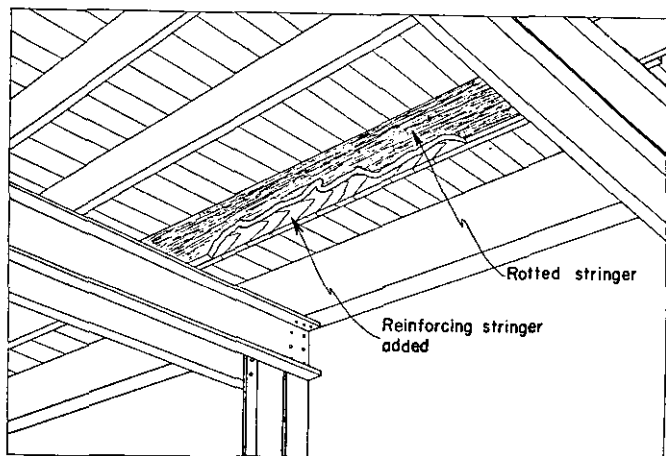

③ Added stringer.

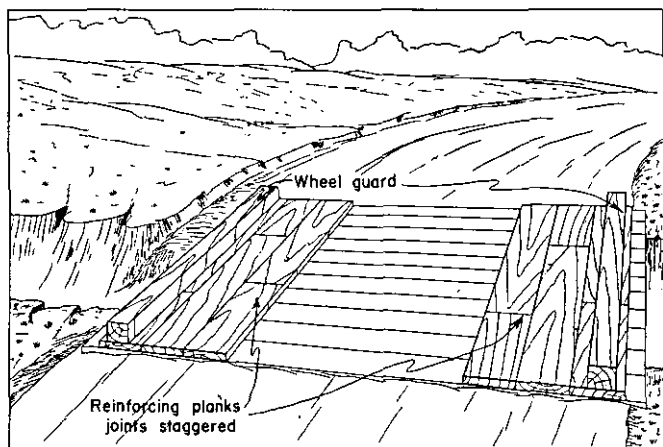

④ Additional planking and wheel guards.
 FIGURE 22.—Reinforcing bridges—Continued.

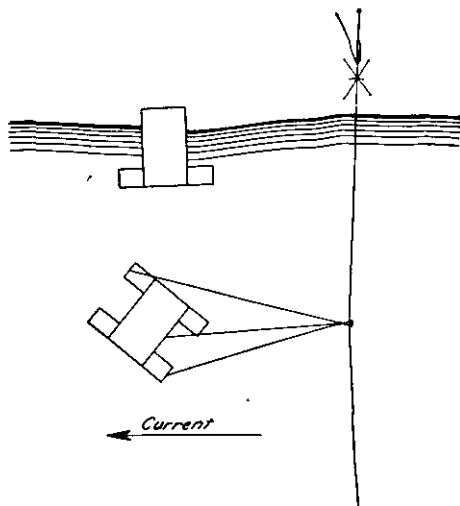

① Trail ferry with landing stage.

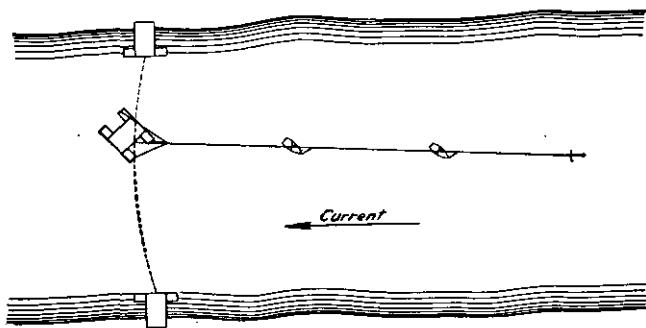

② Flying ferry.

FIGURE 23.—Current operated ferries.

SECTION II

FIELD EXPEDIENTS

■ 175. TRACTION DEVICES.—Antiskid chains (see par. 16) provide the most satisfactory means of increasing the traction of wheeled vehicles. Strap-on emergency chains may be carried in individual vehicles operating alone to provide a quick means of increasing traction in case the vehicle stalls on a muddy road. In an emergency, makeshifts such as short pieces of rope or web belts may be used for the same purpose. The Galinot-Watson, or oval-band type of traction device can be used on the 6 x 6 truck, over the middle and rear wheels; the vehicle, in effect, becomes a half-track vehicle with exceptionally low ground pressure.

■ 176. WINCH TRUCK AND WRECKING CRANES.—Although equipment in different types of motorized units will vary, each organization should have at least one winch truck. Winch trucks and wrecking cranes are employed as follows:

a. Winch trucks normally march near the rear of their units in order to assist vehicles which may drop out of the column. However, if the column is marching over a difficult route, at least one winch truck should be moved to the head of the unit so as to be in a position to assist other vehicles in crossing any obstacles encountered.

b. If necessary, the winch truck is taken across an obstacle under the assisting power of the winch, with the cable attached to a deadman or tree. The power of the drive wheels should assist the winch, but the gears must be so chosen that the wheels will cover ground at the same speed as the winch cable is pulled in.

c. When pulling in a vehicle with the winch, the towed vehicle should likewise assist with its maximum traction. The best power combination generally results if the winch is operated in the highest gear that will give sufficient power and the towed truck is pulling in lowest gear.

d. After the winch truck has crossed an obstacle, the cable may be run out, the winch locked, and the truck used as a towing vehicle, or the truck may be halted and the winch utilized.

e. When the winch is used on a difficult pull, the winch truck may be held in place by use of the brakes and wheel

blocks, or by anchoring to a tree or deadman. Traction devices will assist in holding the vehicle in place. A snatch block may be used to increase the mechanical advantage of the winch when pulls are too difficult for the winch alone.

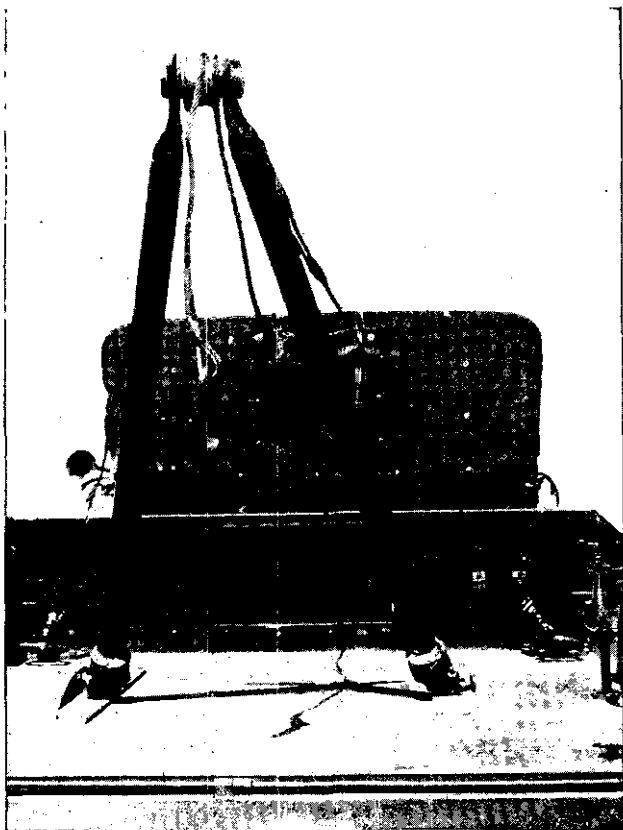

① In position for use.

FIGURE 24.—Wrecking crane.

f. Certain precautions are necessary in the proper use of the winch cable. Whenever the towing cable is slipped over the ground it should be protected by placing pieces of wood

under it. Power must be applied to the cable gradually. As a precaution against the lashing ends of a broken cable, all men should stand clear before the winch cable is tightened.

g. When cable is rewound on drum after use, care must be taken to see that it is wound in neat layers that run entirely across the drum. Otherwise, the cable may be tangled and damaged when the next pull is made. It is also important that all kinks are taken out of the cable before it is used or rewound on the drum. For detailed data on the subject of winches and cables see *Quartermaster Motor Transport Technical Service Bulletin 2-10.*

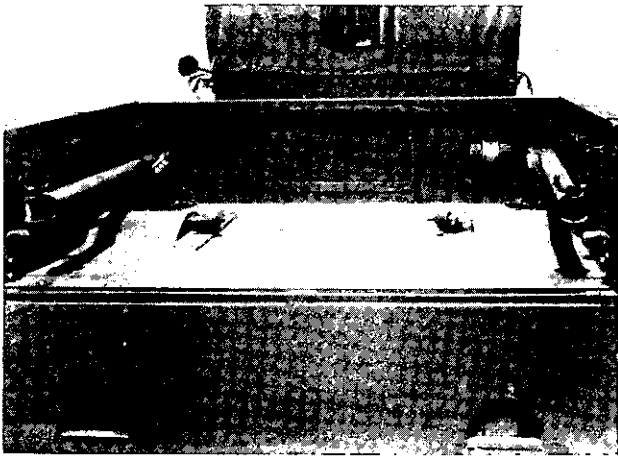

© In traveling position.

FIGURE 24.—Wrecking crane—Continued.

h. Wrecking cranes are intended primarily for use by the maintenance section. They may be mounted in either the winch truck or the tender carrying the equipment of the maintenance section. (See fig. 24.)

i. The wrecking crane can be used to tow one end of a disabled vehicle in an elevated position when the steering mechanism or the axle is damaged. The hoist attachment may be of use in giving a towing lift to a mired vehicle. Care must be taken not to attempt to lift too heavy loads, which will nose-up the hoisting vehicle. In some cases, where lift

only is necessary, nosing up may be prevented by placing short posts under the rear corners of the truck body or by installing a temporary brace under the hoist attachment.

■ 177. WHEEL MATS.—Flat mats improvised by braiding together strands of rope, or pieces of heavy canvas, in sizes of about 3 feet x 6 feet, with ropes attached to the four corners, are useful to place under the wheels where the going is soft. When a vehicle is stalled with wheels slipping, wheel mats may be used by attaching them to the wheels at one end, or they may be laid down in front of the wheels with

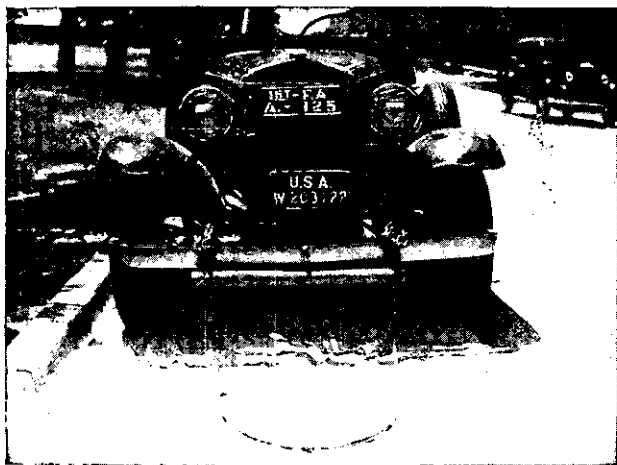

FIGURE 25.—Spreader bar.

the end away from the wheels staked down. To increase traction over a soft or slippery spot, one or several of these mats may be tied end to end. They may then be staked down, held by hand, or tied to trees or rocks by a long rope, or they may be maneuvered ahead of the wheels. Sandbags or, in an emergency, blankets, and like articles may be used to serve the same purpose.

■ 178. TOW CHAINS OR CABLES.—Tow chains or cables should be about 25 feet long and should have a hook on one end and a ring or loop on the other. Cables and chains $\frac{3}{8}$ to $\frac{1}{2}$ inch

give sufficient strength. In addition, double tow ropes 150 feet in length will be found helpful.

■ 179. SPREADER BARS (fig. 25).—To prevent the frame from being bent, improvised spreader bars should always be used to attach a cable or tow chain to both tow hooks.

■ 180. Tow ROPES.—Tow ropes should be about 30 feet long and preferably have a loop at both ends. The loop makes it possible to drop the tow rope over a tow hook before a

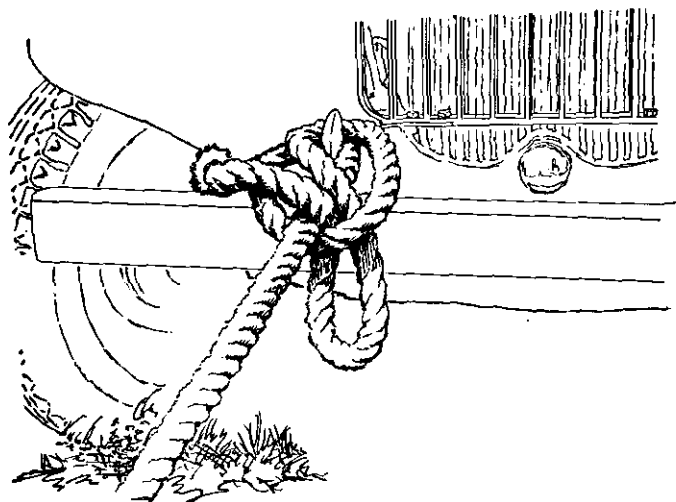

① Clove hitch (end not pulled through).

FIGURE 26.—Knots.

vehicle is completely stalled and, with manpower or a tow from another vehicle, quickly help it past a difficult point. Tow ropes can most safely be attached to tow hooks, pintles, or, in an emergency, around the spring shackle. When tow ropes must be tied, simple knots such as the clove hitch, with end left through to form a bow (fig. 26), should be used. The double Blackwall knot for attachment to tow hooks and the single Blackwall knot for attachment to the pintle are the easiest to untie, but may occasionally slip (see fig. 26). A 1-inch rope will safely stand a tension of about one ton.

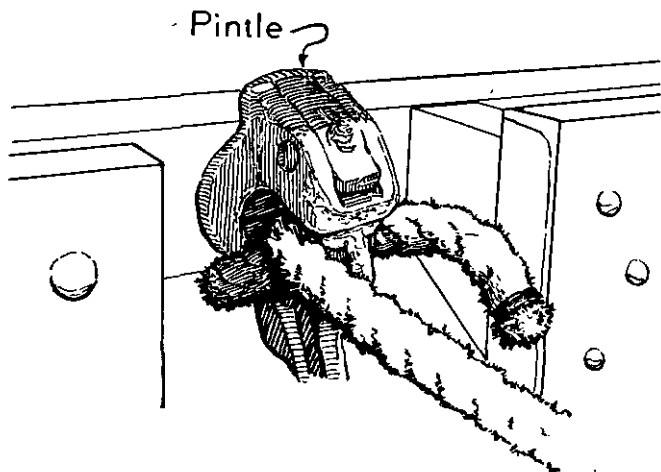

② Single Blackwall knot.

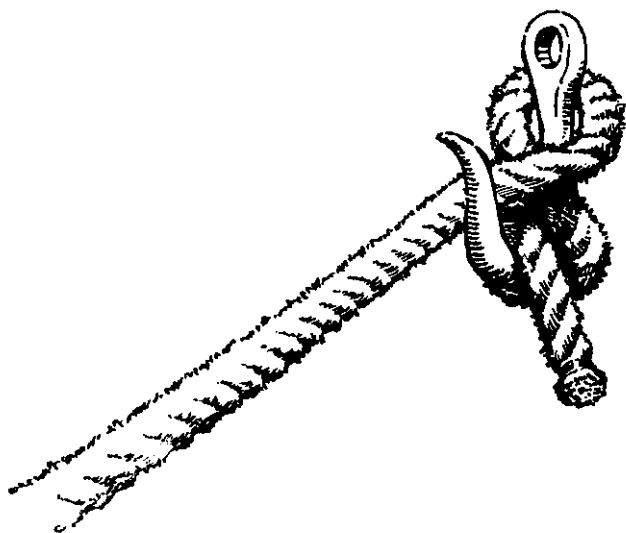

③ Double Blackwall knot.

FIGURE 26.—Knots—Continued.

Safe tension limits for larger or smaller ropes vary roughly as the square of their diameters. The vehicle being towed should always assist with its own power.

■ 181. **BLOCK AND TACKLE.**—When a winch truck is not available, a block and tackle should be carried. A block and tackle attached to a tree, anchored stake, or deadman is useful for increasing the towing ability of either manpower or a towing vehicle.

■ 182. **TOWING BARS** (fig. 27).—Towing bars are used when a vehicle is to be towed a considerable distance.

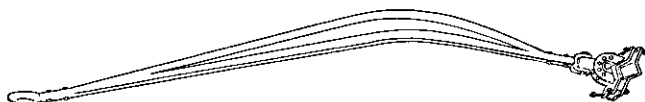

FIGURE 27.—Towing bar.

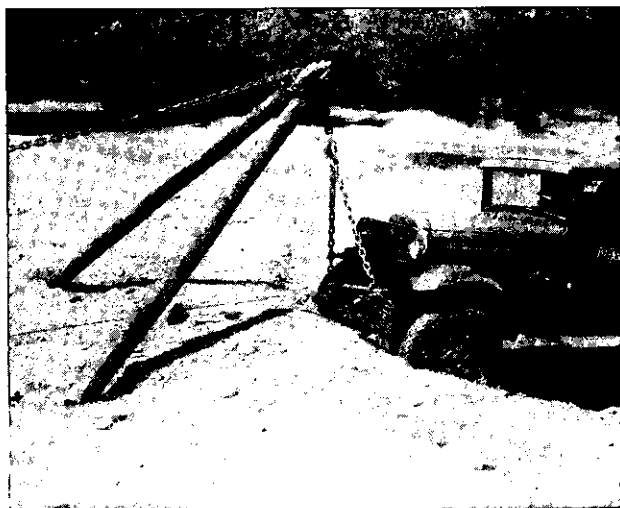

FIGURE 28.—A-frame.

■ 183. **A-frame** (fig. 28).—An A-frame is an expedient which combines both a lift and a tow. It is easily constructed with two poles approximately 12 feet long and two tow chains

or cables. Holes are dug as supports for the foot of the frame, and a cross chain or plank is used to prevent the poles from spreading. Care must be taken to place the A-frame far enough away from the towed vehicle so that, when it is lifted over, the feet of the legs will not damage the front of the vehicle. This simple device is useful when a wrecking hoist attachment is not available to lift a vehicle out of and over a ditch or hole, or when a heavy vehicle is completely mired.

■ 184. DEADMAN INSTALLATION (fig. 29).—The procedure of installing a deadman is to utilize as much surface of undisturbed earth as possible and at the same time prevent rotation out of position. To get the best results the following points are essential:

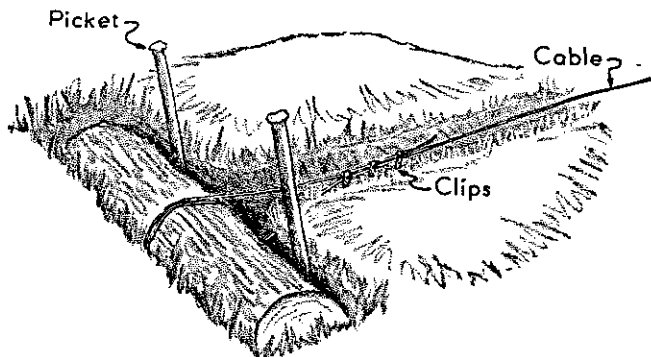

FIGURE 29.—Deadman installation.

a. Position.—A position for the deadman is best if chosen at least a yard behind a natural crest or mound. It should be placed far enough back so that it will not interfere with the vehicles clearing the obstacle, and so that the attached cable or chain will not exert an upward pull.

b. Digging.—A trench is dug deep enough so as to place the top of the deadman at least a foot below the ground surface, and long and wide enough to hold the deadman. The bank in the direction of pull is undercut at an angle of about 15° from the vertical. The bottom of the hole is cleared at a right angle to this bank. To assist in strengthening the top edge of the hole in the direction of pull, two stakes are

usually driven on either side of the cable at a slightly greater angle to the vertical than the bank, and so as to be flush with the slanted bank near the top. A trench for the cable is cut from the hole through the crest of the hill or mound. This should be slightly deeper than the bottom of the hole at the beginning and should continue out in an ascending slope,

c. Cable attachment.—A rectangular railroad tie or larger timber of the type used for a wheel block is most suitable for the deadman, since it presents the maximum surface to oppose the direction of pull. The cable or chain is attached to the deadman so that the largest area of the deadman is against the bank, and so that any tendency of the deadman to rotate acts downward and not upward.

■ 185. ANCHORED STAKE (fig. 30).—Two stakes and a rope lashing may be used to install an anchored stake which will withstand considerable pull. The first stake is driven into the ground at a little greater than a right angle from the direction of pull. The second stake is driven at an angle slightly closer to the ground and 3 to 6 feet to the rear of the first stake. A rope is used to anchor the top of the first stake to the bottom of the second. In order that this rope

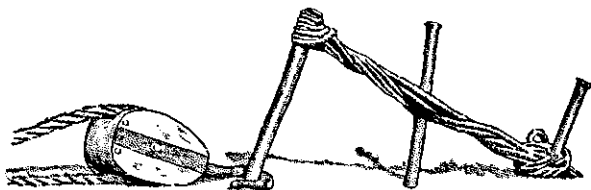

FIGURE 30.—Anchored stake.

will not slip down on the first stake, it is first tied to the bottom of the second, then wrapped over itself with a one-half clove hitch at the top of the first stake. The rope then is passed around the second and another half clove hitch is completed over the first, wrapping the rope around below the first hitch. This lashing is completed a number of times before the rope is secured to the second stake. A third stake may then be used to twist the lashing tight, after which it is driven into the ground. The operation may be continued with an additional stake to give a still stronger anchorage.

■ 186. MECHANICAL EXPEDIENTS.—The usual limitations for repair of the vehicle by the driver are stated in chapter 2. However, the following repairs can be made in the field when it is essential for a vehicle to proceed under its own power in an emergency:

a. Broken spring leaves are splinted by means of strong pieces of wood or metal held in place with wire. One or several tent pins may be used. If necessary, a block of wood is secured between the frame and axle to prevent spring action. When necessary, displacement of the axle is prevented by running a wire around the front spring hanger and the axle. The vehicle should be driven very slowly, and road bumps should be avoided until repairs can be made.

b. *When the light fuse is burned out, it may be temporarily replaced with tin foil.* This should be done only after the short in the system has been corrected. Remove tin foil as soon as possible and replace with correct light fuse.

c. A fan belt may be replaced with rope waist belt, or the old one fastened together with wire. Friction tape may be wrapped around the belt to reinforce such splices as are made.

d. When water has shorted the ignition system, it should be wiped away from the spark plugs, distributor head, and coils. The wires should then be removed from the distributor head and wiped dry. After drying, spark plugs and all contacts should be wiped with cloth moistened in kerosene or fire extinguisher fluid.

e. Loose or broken wires may be repaired temporarily by splicing and covering splice with friction tape.

f. Canned milk will often stop the average radiator leak.

SECTION III

DIFFICULT OPERATIONS

■ 187. POINTS TO BE OBSERVED (see TF 6-104 and 6-106).—When moving across country or under other difficult conditions the following points should be observed by officers and noncommissioned officers:

a. The leading vehicle should have a selected driver and should be in good mechanical condition.

b. On approaching doubtful crossings or steep hills, a quick reconnaissance to determine the best route is made on foot ahead of the first vehicle.

c. Guards are dropped where necessary to caution drivers in rear.

d. While moving, a driver is given freedom in the operation of his vehicle within the limits of safe and efficient operation of the column.

e. When a vehicle is stalled, the driver must be given advice and help. A decision is required at once as to whether or not it can be moved by the next vehicle or by men at hand. If it cannot be moved without holding up the column, it is left for the trail or maintenance officer to handle.

f. The column must be kept moving. When the road is blocked, a detour route is immediately found for other vehicles.

■ 188. POWER, MOMENTUM, TRACTION, AND FLOTATION.—The ability of a motor vehicle to negotiate difficult terrain depends upon its power, momentum, traction, and flotation. A proper appreciation of these related factors will assist military personnel in the choice of a practical expedient to meet most road difficulties.

a. *Power* in any gasoline-propelled vehicle depends primarily upon maintaining sufficient engine speed. A shift to a lower gear allows the application of more power, but with a loss of forward momentum.

b. *Momentum* is the energy stored up by the weight of the vehicle in motion. It increases with the speed of the vehicle.

c. *Traction* is the ability of the wheels or track of an automotive vehicle to adhere to the road.

d. *Flotation* is the ability of a wheel or track to ride the ground surface. Flotation increases with the area of ground contact afforded.

■ 189. ASCENDING STEEP SLOPES.—a. *Approaching normal hill*.—On approaching the usual hill, the leading driver should select a sufficiently low gear and proceed to the top without attempting to race his engine to keep up the normal rate of march. The driver of each succeeding vehicle closes up as the ascent begins and loses distance as the vehicle ahead picks up speed at the crest.

b. *Approaching difficult short slope, grade or hill*.—Where the grade is slippery or the slope particularly steep, the leading driver on approaching the hill should select a sufficiently low gear to gain the maximum momentum which his load

and the condition of the road permit. The driver of the next vehicle should slow up and halt before he arrives at the approach. He should wait long enough to see that the vehicle ahead has cleared the crest. The driver of each succeeding vehicle should follow only after being certain that the vehicle ahead will negotiate the hill.

c. Overcoming failure.—On a steep ascent, stalling usually occurs because of either power or traction failure. Four solutions are presented:

(1) *Taking another run.*—If a driver has failed to give his vehicle the maximum momentum practical on the approach, or if a shift has been made at the last moment in an effort to increase the power, the driver is usually at fault. Another trial, with the maximum momentum practicable or with a lower gear ratio, may succeed.

(2) *Increasing or decreasing load.*—If power fails with maximum momentum and the lowest gear ratio the load may be decreased. However, if failure is due to loss of traction when flotation is good, sufficient traction may be gained by increasing the load. This is usually done by loading men over the driving axle or axles. This solution will often be successful on vehicles with two-wheel drives, and on empty vehicles moving heavy towed loads. On nontowing vehicles having front-wheel drives, the addition of more than the normal load is seldom advisable, because these vehicles usually have sufficient traction to pull to the limit of their power.

(3) *Applying traction devices.*—If the road is soft or slippery, skid chains or other traction devices should be installed.

(4) *Towing.*—Towing is usually the most expeditious method of getting over a difficult ascent. If the hill or critical ascent is short, the use of man power pulling on a tow rope is usually the quickest and most practical method. If the hill is long and a winch truck is available, it should go up first and then pull the other vehicle over. If one truck can be pulled over, a long rope, cable, or chain may be used to connect each vehicle in turn so that each helps the next over the ascent. Towed loads may be disconnected and pulled up separately. If necessary, several vehicles may be connected in tandem to pull up a towed load.

d. Precaution.—When a vehicle stalls on a hill, the driver should not shift gears until he has tested the brakes by dis-

engaging the clutch gradually. After the brakes have been tested and found to hold, the driver should shift to reverse and keep the vehicle in gear while backing down the hill or off to the side of the road.

■ 190. DESCENDING STEEP SLOPES.—Steep descents should be approached as cautiously as steep ascents. The following precautions should be observed:

a. *Choosing descent.*—Very steep slopes should be descended straight down, so that in case sliding occurs the vehicle will not get out of control. All personnel except the driver should be dismounted.

b. *Braking.*—Hills should always be descended in gear. The correct gear for the descent of a steep slope should be chosen during the approach and should not be changed until the bottom of the hill is reached. As a rule, the same gear is required in going down a hill as would be used in coming up the same hill. A sufficiently low gear should be selected so that the brakes need not be used. However, when necessary, the driver should apply the brakes intermittently, being careful not to lock the wheels. The tendency of trailers and semitrailers to "jack-knife" when stopping or when descending grades can be prevented by applying brakes on towed load in such a manner that a drag on the towing vehicle or prime mover is created. In the descent of a hill, no attempt should be made to maintain the normal rate of march by racing the engine. The ignition should not be turned off.

c. *Assistance.*—Outside assistance should be given to vehicles descending steep slopes. It may be applied as follows:

(1) By manpower through the use of tow ropes, or block and tackle. A tree or post may be used for snubbing the rope.

(2) By use of another vehicle connected by chain, cable, or rope to the vehicle descending, both descending in low gear.

(3) By use of the winch, the cable being run out in gear, the descending truck operating in the lowest gear.

(4) By setting brakes on towed loads and attaching a safety rope or tackle. When necessary, towed loads should be disconnected and let down separately.

■ 191. MUDDY ROADS.—The usual muddy road that will be encountered is soft and slippery on the surface, while underneath it is generally hard or will pack sufficiently to support a vehicle. Soft spots will allow spinning wheels to dig in

quickly. The following suggestions are applicable to negotiating this type of muddy going:

a. Traction aids.—Skid chains usually give the best aid to traction and reduce skidding.

b. Gear.—In general, the highest gear that will give sufficient power is selected. As the loss of momentum and the sudden application of increased power at a critical point start the wheels to spin, the need for a gear reduction must be anticipated.

c. Momentum.—Momentum should be maintained across slippery places and up grades. Usually when slipping occurs, the speed of the engine should immediately be decreased so that the wheels can take hold.

d. Choice of track.—Old ruts are the hardest packed and should generally be chosen. This principle usually holds for all vehicles following the first. The exception to this rule is covered in paragraph 192. Where road centers are high ruts should be straddled, or a new track should be made.

e. Procedure on stalling.—Once a vehicle has come to a complete stall in mud, the clutch is disengaged at once. No new trial is attempted until an outside check-up is made. Proper procedure for quickly extricating a stalled vehicle is dependent upon judgment and experience. The following possibilities are suggested:

(1) *Dismounting personnel.*—If personnel are carried, they should dismount and try to push the vehicle out. Often the lightened load and this applied power will be sufficient. In making a try with outside aid, the driver should apply power to the wheels gradually by easing in the clutch. This trial should not be continued to such an extent that the wheels dig in.

(2) *Selecting best way out.*—Usually a vehicle can be moved backward for a new trial easier than it can be moved forward.

(3) *Use of manpower.*—If tow ropes and sufficient men are available, an immediate attempt should be made to move the vehicle by manpower.

(4) *Applying nearest suitable tow.*—If a light tow will probably succeed, the next suitable vehicle ahead or behind may be used. Often the next vehicle can be detoured and used for a tow. Where the vehicle has slid off a highly crowned

road, men with tow ropes attached to the sides of the vehicle may assist in helping the vehicle back onto the road.

f. Stalled vehicle.—Where the above expedients will not suffice, a winch, tractor, vehicles in tandem, or a block and tackle must be used. Where a vehicle operating alone becomes stalled in mud, the driver and any personnel that may be with him are dependent on one of the following methods of extricating it:

(1) *Improving traction.*—Any additional traction devices, such as wheel mats or skid chains, may be applied. Often one or more drive wheels must be jacked up and traction and flotation increased by placing brush, boards, rocks, or similar material under the wheels. If a pole is available, it may be used as a lever and inserted under the hub or axle in order to raise the wheels.

(2) *Digging out.*—Ditches dug in the direction that the wheels are expected to move assist in moving the vehicle out. When wheels are in deep ruts, ditches dug at an angle to the ruts may be necessary in order to assist the wheels back to a straddle position over the rut. In this case the ruts should be filled.

(3) *Windlass method.*—The windlass method of having a dual-wheel truck pull itself out of a bad mud hole is simple and rather certain of success. Two tow ropes and six stakes are required. Two anchored stakes are installed on the bank at the same distance apart as the wheels and directly in front of or behind the vehicle. The loop ends of the ropes are taken in between the tires of each dual wheel and secured by passing the loop between the spokes and over the hub. The ropes are then attached to the anchor stakes. When this is done the vehicle can move out on its own power by allowing the tow ropes to wind up between the dual wheels.

(4) *Pole method.*—It may sometimes be possible to obtain sufficient traction by inserting a pole as a track between the dual wheels that are slipping.

g. Caution.—Because of the danger of slipping under the vehicle, personnel should be cautioned against pushing on the side of a moving vehicle that has slipped into the ditch from a high crown road, or on a vehicle that has slipped into old wheel ruts.

■ 192. SWAMPY OR BOGGY GROUND.—Where water has been standing for a considerable time and swamp grass has grown, a surface crust has usually formed on top of a bottomless soil. Certain variations in principles and procedure apply in this exceptional type of muddy going.

a. Avoid swamps if possible.—Boggy or swampy soil may usually be avoided. Every effort should be made to move over the highest ground available.

b. Unload personnel.—Personnel should dismount and assist with tow ropes at critical points.

c. Maintain momentum.—The main requirement in moving over a boggy piece of ground is to move over it rapidly without stopping. Wheel spinning should be kept at a minimum.

d. Follow separate tracks.—The grassy crust may carry one vehicle but may not support another in the same track. Therefore, each vehicle should follow a separate track. A guide should precede each vehicle on foot, locating the hard ground and guiding the driver carefully over the best route.

e. Stalling.—When a vehicle comes to a flotation stall, the clutch should be disengaged at once to avoid "digging in" of the wheels. No attempt should ever be made to move it without outside power.

f. Towed loads.—To pull towed loads, several trucks may sometimes be hooked in tandem; or they may be placed abreast, with the towed load attached by a pulley sliding on a cable between the two trucks.

g. Deflating tires.—Flotation may be increased by deflating tires.

■ 193. GUMBO AND OTHER STICKY SOILS.—Gumbo and other sticky soils present a problem similar to that of boggy ground. In addition, these soils give little traction and stick to the tires and wheels in great masses. Boards, shovels, knives, and the like may be fastened to the truck body to scrape the mud from the wheels. Whenever possible, old, hard-packed roads should be selected through these areas.

■ 194. PASSING THROUGH SAND.—Flotation in sand increases more or less below the surface. Usually sand will support a vehicle moving rapidly. However, traction is very limited because wheels are continually slipping. As soon as a drive wheel begins to spin it digs in fast. Generally the methods

described in paragraphs 191 and 192 will be applicable. However, the following additional expedients may be used in overcoming traction failures in sand:

a. Improve surface.—Chicken wire fencing or heavy burlap staked on the surface of sand will usually make satisfactory surface for movement of motor vehicles. For long columns, two thicknesses should be used. Maintenance personnel should be provided.

b. Follow in track.—In order to reduce rolling friction, vehicles should follow exactly the tracks of the vehicle ahead.

c. Dig vehicle out.—When the sand is somewhat encrusted below the surface, the vehicle will continue to creep while the wheels spin. As long as the vehicle continues to move, the wheels may be kept slowly spinning, allowing the vehicle to dig itself out.

d. Increase tire surface.—In exceptional circumstances air pressure may be decreased in the tires to give sufficient flotation.

e. Avoid changing gears.—As it is imperative that momentum be maintained changing of gears must be avoided by selection of proper gear before entering the sand.

■ 195. CROSSING FROZEN STREAMS.—*a. Carrying capacity of ice.*—See paragraph 134.

b. Increasing carrying capacity of ice.—(1) Planks may be used to distribute weight of wheeled vehicles and thus increase bearing power of ice.

(2) In freezing temperatures, thickness of ice may be increased by flooding surface of ice. Water can be confined to desired area by means of low earthen dams. Belt of thickened ice should be at least three times the width of roadway to be used. Piling of snow on the surface of ice and flooding the snow with water will accomplish the same result as when water alone is used.

(3) When a river is frozen on each side but open in the middle due to a swift current, a boat or other surface obstacle placed across the interval will often check the current enough to permit freezing.

■ 196. DRIVING ON SNOW AND ICE.—On soft snow flotation is at a minimum, while on ice traction is at a minimum. In

addition to many of the principles already listed, the following are applicable to winter driving:

a. Traction aids.—Skid chains on all wheels are usually the best safeguard in normal winter driving. However, on glare ice skid chains add little or no traction and are apt to give a false feeling of security. Deflating tires will assist in preventing skidding.

b. Moving over fresh snow.—When breaking freshly fallen snow, manpower should be readily available to push or tow the first vehicle where the snow is deep. Other vehicles follow exactly in track and usually can move under their own power provided they are able to gain sufficient momentum in approaching difficult slopes and crossings. Alternate shifting from reverse to forward gears often will "rock" a vehicle out of a hole in snow.

c. Braking.—In slowing down or descending hills, the engine should be used as a brake. The driver shifts to a lower gear when more braking power is needed. Foot brakes, when used, should be applied lightly and released quickly if skidding begins.

d. Accelerating.—Rapid acceleration should not be attempted, as it may cause one drive wheel to spin, thus losing traction or causing skidding.

e. Overcoming skidding.—If skidding occurs, the brake or clutch should not be touched. The accelerator should gradually be released. The front wheels are turned in the same direction the rear wheels are skidding, so that the vehicle will be carried forward by its momentum in a straight line parallel to its original path. This method will ordinarily result in reobtaining traction.

f. Holding vehicles on road.—Where necessary, men with tow ropes may be used to hold vehicles on dangerous icy roads.

■ 197. CROSSING DITCHES AND DEEP RAVINES.—*a. Narrow or shallow ditches.*—Ditches with width approximating the diameter of the wheel, and wider shallow ditches, should always be traversed at an angle by two-wheel drive vehicles so that the drive wheel on one side will take hold of the far edge of the ditch at the same time that the opposite wheel is going into it. As this angle of crossing is a severe strain on the frame, springs and driving mechanism, personnel should dismount, and the ditch must be crossed slowly.

Multidrive vehicles can usually cross ditches at a right angle, and thus avoid unnecessary strain on the frame and body.

b. Wide ditches or ravines.—When a ditch is wider than the diameter of the wheel and deeper than the running board or undercarriage clearance, no attempt should be made to pass it until the banks are cut down or the bottom filled with solid material. Such ditches should be crossed at right angles. If they are wet, they should be approached slowly and the vehicle speeded up, but without causing wheel slipping, just as the front wheels cross the lowest point.

■ 198. FORDING SHALLOW STREAMS.—Fordings should be attempted only after careful reconnaissance. Maximum depths of fords are given in paragraph 133. The following points should be observed when fording a shallow stream:

a. Cross slowly.—As a rule nothing is to be gained by attempting to use momentum in crossing streams. They should be crossed slowly in a low gear.

b. Disconnect fan.—If there is any danger of the water surging or splashing into the fan, the fan should be disconnected for the crossing.

c. Dry brakes.—After crossing a stream brakes should be applied intermittently until dry enough to hold.

d. Check lubrication.—At the first opportunity, wheels, crankcase, universal joint, differential, transmission, and subtransmission should be checked for proper lubrication.

e. Exhaust manifold.—If streams are wide, disconnect the exhaust manifold.

■ 199. DEEP STREAM CROSSING.—When the situation demands that streams too deep for fording be crossed, the first consideration should be to secure engineer assistance, or to obtain, or improvise ferries, or rafts. However, even if none of these are available, it is possible to tow vehicles across streams of almost any depth without serious damage provided suitable precautions are taken. The tackle and tow indicated in figure 31 are used. The vehicle must be properly prepared for submersion by closing all openings and removing such parts as will be seriously harmed or rendered inoperative by moisture. After crossing, the vehicle should be thoroughly serviced and all water removed.

■ 200. BRIDGES.—Speed, caution, and bridge capacity signs should be carefully observed. (See par. 94 for estimating capacity of bridges.) When the capacity of a bridge is not sufficient to carry both a prime mover and towed load, the towed load should be pulled across by a tow line longer than the bridge. Track-laying vehicles should be started across a bridge so that they will not have to be turned, because steering them places a severe strain on the bridge.

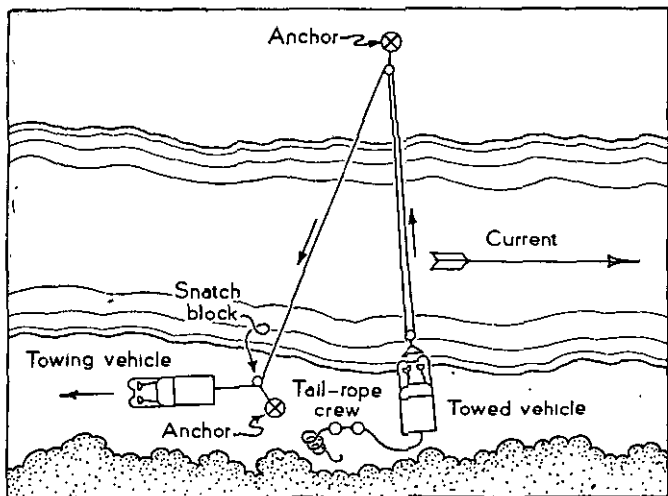

FIGURE 31.—Tackle for deep stream crossing.

■ 201. DRIVING ON SLIPPERY CURVES.—Skidding on slippery curves is avoided by a reduction of speed before the vehicle goes into the turn. The tendency to skid arises from two factors (both of which are restricted by the friction between the vehicle wheels and the surface of the road).

a. Centrifugal force tends to throw a vehicle to the outside of a curve; it varies as the square of the speed.

b. When the brakes are applied the weight of the load is shifted from the rear wheels to the front wheels, reducing the traction on the rear wheels and increasing the tendency to skid. When the brakes on a towed load are not applied, the tendency to skid is increased for the same reason. Ex-

perienced drivers may counteract this tendency to skid by accelerating their vehicle after it enters the curve.

■ 202. **NEGOTIATING TURNS WITH A TOWED LOAD.**—If a curve is too sharp for a truck and towed load, it is usually possible to uncouple the truck, drive it around the turn, and then pull the towed load around the turn by use of a tow rope or block and tackle.

■ 203. **RIGHTING AN OVERTURNED VEHICLE.**—Overtaken vehicles can often be righted by manpower alone. When this is impossible, a rigging similar to that shown in figure 32 may be used. Brakes should be applied before the vehicle is righted. Any of the towing means may be used to pull on the rope.

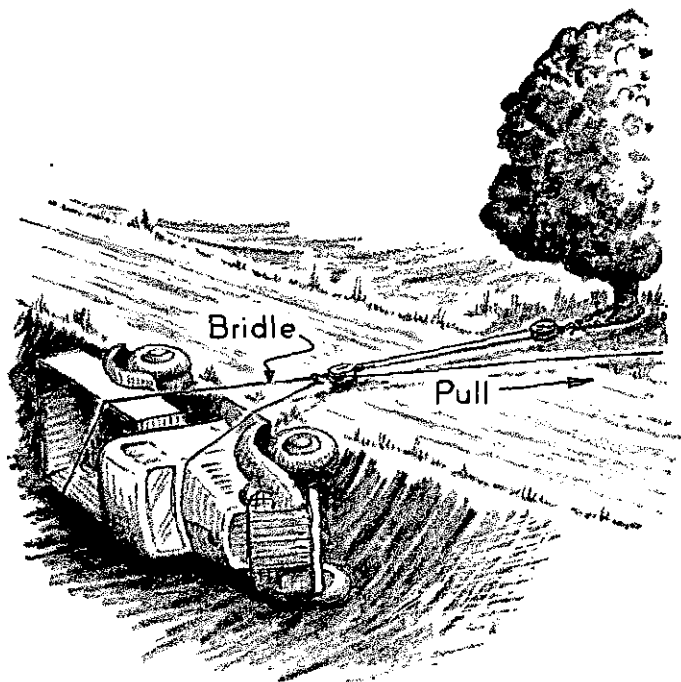

FIGURE 32.—Righting an overturned vehicle.

Holding lines should be used to prevent damage to the vehicle from its settling too rapidly. When the vehicle has been righted, a careful inspection must be made to determine the extent of any damage caused by the accident. The axles may be bent, the frame twisted, the wheels bent or broken, or the steering mechanism damaged. Such damage should be repaired as soon as possible, since driving the damaged vehicle invites other and perhaps more serious accidents. Before the vehicle is moved under its own power, necessary oil and gas, battery acid, and radiator water should be replaced.

CHAPTER 7

MILITARY AUTOMOTIVE MAINTENANCE

	Paragraphs
SECTION I. General-----	204
II. Organization for maintenance-----	205-209
III. Echelons of maintenance-----	210-215
IV. March maintenance-----	216-221
V. Lubrication-----	222-227
VI. Inspections-----	228
VII. Records and reports-----	229-230

SECTION I

GENERAL

■ 204. BASIC PRINCIPLES.—*a.* The primary purpose of motor transport maintenance is to meet military transportation requirements with a minimum loss of time from avoidable repairs. The Army system of maintenance is based on—

(1) Scheduled preventive maintenance, unit replacements, minor repairs, and the inspections necessary to insure economical, uninterrupted vehicle service.

(2) Systematic detection and correction of incipient vehicle failures before they occur or develop into major defects, and the servicing necessary to maintain motor vehicles in a satisfactory operating condition.

(3) The necessary major repairs to worn out or otherwise defective subassemblies, units, or vehicles.

b. The principle of unit replacement, rather than major repair to a unit while installed on a vehicle, is to be practiced whenever replacement units are available. An exception is made when a repair can be accomplished without dismantling a unit or removing it from a vehicle, or when any repairs can be made more expeditiously by repairing than by replacing the unit. When an unserviceable unit is removed, but is repairable, it is dismantled and rebuilt. The unit repair or overhaul is normally a fourth echelon function, quartermaster or ordnance. A rebuilt (overhaul) unit is thus made available as a replacement assembly either for immediate use, or for return to stock for future use.

c. To insure the combat efficiency of motor vehicles during field service, the maintenance system within organizations must be adequately and properly supplied with tools and equipment, must have trained personnel and a limited supply of parts and repair items with a reserve promptly available. Organizational maintenance is based upon—

(1) Meeting needs of motor transport operating in the field.

(2) Limited decentralization of maintenance within the regiment, the battalion, the squadron, or similar organization.

(3) Prompt and adequate support from the service motor maintenance and motor supply organizations.

(4) Anticipation of motor vehicle casualties as a result of field service and the necessity for prompt repair or replacement. Maintenance facilities immediately available and the existing field conditions will determine whether these casualties are to be repaired by the operating organization or by the repair establishment of the supporting service (quartermaster or ordnance).

(5) Prompt replacement of unserviceable vehicles which cannot be repaired within the time demanded by the particular tactical situation or emergency.

d. The economic factors in peace affect all phases of motor maintenance as a function of garrison or post routine. This must not obscure the correct conception of motor maintenance under field service conditions. The shop equipment usually used in post shops is inadequate or incorrectly designed for field use. To insure efficient field motor maintenance, garrison training must stress the use of the specialized field maintenance tools and equipment.

e. Care must be exercised by all concerned to retain the distinction between organizational maintenance and service maintenance. Under field conditions, organizational maintenance activities must not exceed their prescribed scope. The facilities of the higher service echelons (quartermaster and ordnance) must be fully used.

SECTION II

ORGANIZATION FOR MAINTENANCE

■ 205. **ESSENTIAL MAINTENANCE FACTORS.**—Motor maintenance depends on four essential factors:

a. *Personnel*.—properly trained and technically qualified for the particular work assigned;

b. *Tools and equipment*.—adequate and proper for the work to be done;

c. *Supplies*.—correct as to kind, size and quality;

d. *Time*.—available and sufficient to complete the work to be done.

■ 206. **TYPES OF MAINTENANCE**.—The motor maintenance prescribed for the military service is a flexible system that can be adapted to various operating conditions. This system is divided into two main divisions with subdivision as indicated:

a. *Organizational maintenance*.—(1) *First echelon* (driver maintenance).—Preventive maintenance is limited by the tools and equipment made available to the motor vehicle operator. Definite maintenance duties are to be assigned to the motor vehicle operator and he should be prohibited from performing any maintenance function not specifically within the category of lubricating, tightening and cleaning his vehicle. (See sec. III, ch. 1.)

(2) *Second echelon*.—The duties of this echelon include preventive maintenance, adjustments, minor repairs and unit replacement within the limits of the time available, utilizing hand tools and light portable equipment authorized in Tables of Basic Allowances.

(3) *Responsibility*.—Organizational maintenance (first and second echelons) is the responsibility of the commanders of units to which the vehicles belong.

b. *Service maintenance*.—(1) *Third echelon*.—(a) The functions of this echelon are—

1. Supply of units and parts.
2. Unit replacement beyond the scope of the second echelon.
3. Repairs involving the use of mobile shop equipment, and the services of general automotive mechanics, and a limited number of automotive trade specialists.
4. Evacuation to other service echelon shops, when the required repairs are beyond the capacity or scope of second and third echelon facilities.

(b) The third echelon (quartermaster or ordnance) is equipped to serve a number of motorized or armored organizations as single large commands. It is under the direction of the higher unit commander. It technically supervises motor operations and maintenance activities of organizations to which it is assigned.

(c) Maintenance units of the third echelon are organized and equipped to provide immediate decentralized support to motorized or armored organizations requiring it.

(2) *Fourth echelon.*—(a) This normally will function as a fixed motor repair shop established in conjunction with motor supply depots; it may under special conditions be semimobile. A limited amount of fourth echelon repairs will necessarily have to be accomplished in the field with a large unit or combination of units of armored force when operating on distant missions.

(b) The functions of this echelon are—

1. Supply of units and parts to all lower echelons.
2. General overhaul and reclamation of vehicles, units and parts involving the use of heavy equipment, and the service not only of general automotive mechanics, but of highly trained specialists capable of performing the most difficult repairs.
3. In an emergency, this echelon may even be required to engage in manufacturing to meet special conditions.

(3) *Responsibility.*—Service maintenance (third and fourth echelons) is the responsibility of the commander of the unit to which third and fourth echelon service units are assigned.

■ 207. ORGANIZATION.—a. The commander of a regiment, of a battalion or squadron, and of a battery, company or troop, depending upon the type of organization and the conditions under which it is serving, is responsible for the first echelon maintenance and for part or all of the second echelon work.

b. While the designations and specific duties may differ slightly according to Tables of Organization and practices of the arms or services concerned, the organization chart and outline of functions and of personnel (shown in table IV) can be used as a general guide for lower (organizational) echelons.

■ 208. PERSONNEL.—*a. General.*—(1) Motor transport personnel ranges from the regimental commander, who is directly responsible for the efficiency of his command, through subordinate officers and noncommissioned officers to the technicians, skilled artisans, drivers and other personnel necessary to the performance of required duties. Operation, maintenance and supply of motor transport activities are highly specialized and are closely interwoven; they include command and technical supervision, administrative control and other functions necessary and vital to efficient motor transportation. While responsibilities must be definitely fixed, the actual performance of duties in connection with motor transport must be decentralized as far as possible.

(2) The unit commander who is directly responsible to higher commanders normally has a technically qualified motor officer directly responsible to him for all organizational motor transport activities.

(3) When fleets of motor vehicles are assigned, Tables of Organization provide, in most instances, the personnel necessary to supervise and perform required motor transport duties. This personnel is usually part of either the headquarters or service battery, company or troop of the regiment and is administered by its commanding officer. Organizational maintenance (first and second echelon) work is performed by this personnel.

(4) Noncommissioned officers and other enlisted personnel, known as truckmasters, motor sergeants, chief mechanics, motor supply sergeants, chiefs of sections and squad leaders, assist in the supervision and technical administration of motorized organizations. When all vehicles of the organization are pooled and all maintenance functions are performed by the regimental or similar unit personnel, all personnel involved are centralized. However, the organization is generally such that the personnel, the tools and equipment, and the supplies can be decentralized into battalion maintenance sections and if urgent, into battery, company or troop groups.

(5) The success of preventive maintenance within a regiment or similar unit, depends upon the judgment, energy, ability and common sense, not only of the commander, but also of all subordinates. The training, discipline, morale and effectiveness of the latter will also have a direct bearing

upon the efficiency of the motor transport of the organization. In order to insure a high state of efficiency during motor transport operations, the commander should—

(a) Separate, as much as possible, vehicle operation and maintenance functions, other than first echelon.

(b) Establish and fix definite responsibilities for such functions.

(c) Maintain high standards for all work.

(d) Make vehicles available for cleaning, lubricating, servicing and maintenance inspections, as required.

(e) Make provisions for scheduled preventive maintenance work and enforce it by frequent checking.

(f) Establish a simple method of recording data on vehicle operation, inspections, lubrication, servicing, and repair work.

(g) Make provisions for and conduct schools to insure proper and uniform training of personnel, including drivers and mechanics.

(h) Provide necessary guide forms for routine lubrication, maintenance inspection and scheduled preventive maintenance work on all types and makes of assigned motor vehicles.

(i) Make the command inspections necessary to insure proper coordination and functioning of all personnel.

(j) Motor operation and maintenance are functions of command. Continuous and efficient operation by a motorized organization requires that all command personnel give to maintenance activities the necessary time and effort to obtain desired results.

(k) If a command is to retain its mobility, unusual operations require unusual maintenance efforts. Although a commander may properly delegate authority to his motor officer and other subordinates, considerable personal and active control on the part of the commander is necessary to maintain any fleet in a high state of operating efficiency.

b. Motor officer.—The organizational motor officer should be selected from those having either technical automotive training, practical automotive experience, or a particular aptitude for the work.

(1) Technical supervision is a distinct responsibility of the motor officer whether the maintenance functions are centralized in one activity or decentralized to the battery, company or troop.

TABLE IV.—Lower echelon (first and second) organization
CHART AND OUTLINES OF FUNCTION AND OF PERSONNEL

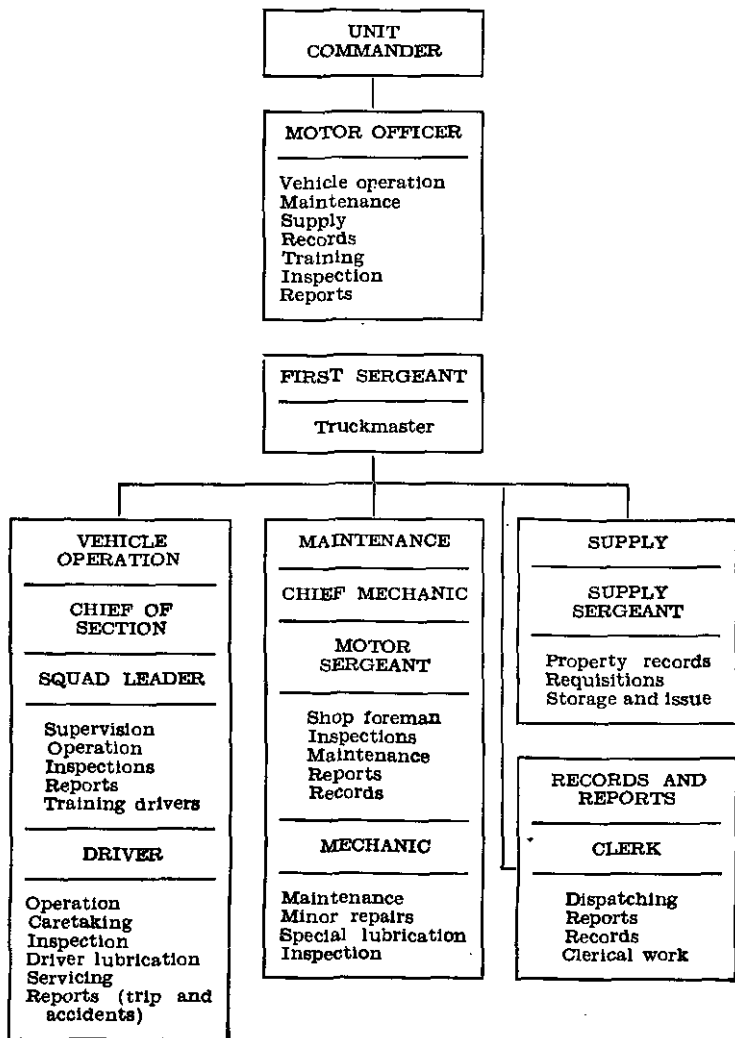

(2) The organizational motor officer (regiment or similar unit), as a representative of the commander should develop a uniformly high standard of operation and maintenance throughout the regiment by exercising close technical supervision.

(3) He must be cooperative and diplomatic in his dealings with subordinate unit commanders and instill a feeling that he is assisting them in the necessary performance of work. He must be careful to avoid assuming command of the battery, company or troop maintenance personnel.

(4) He must assist personnel concerned with necessary technical information by preparing guide forms, by informal individual instructions, or by organized group instruction attended by personnel of the regiment.

(5) The motor officer checks on the performance of maintenance work by calling, without prior notice, for specific vehicles of the regiment. Information obtained through these special maintenance inspections, together with general observation of the vehicles brought in for routine repairs and observation of the personnel of subordinate organizations while at work, will indicate the condition of vehicles and the quality of maintenance work being performed. Where unsatisfactory vehicle operation or maintenance is observed, the regimental motor officer should usually first advise the subordinate unit commander concerned and make suggestions for the corrective measures to be taken. When improvement cannot be obtained through this procedure, the matter should then be reported to the regimental or similar superior commander.

(6) The motor officer should familiarize himself with all vehicles of the organization, their peculiarities and limitations, and with the special considerations to be given them in accordance with instructions contained in the vehicle manufacturer's operation and maintenance manuals. He should be able to inform his immediate superior at any time of the general condition of the vehicles in the organization. He is essentially the technical adviser to his immediate superior and is responsible only to him for all technical features pertaining to organizational motor transport.

(7) The duties of the regimental or similar motor officer include—

(a) Commanding the regimental motor maintenance section, platoon or company. In certain types of organization, such as motor truck companies and light and heavy motor maintenance companies, he may also be commanding officer of the entire organization.

(b) Coordinating and consolidating all requests for third echelon repairs. Coordinating with the higher motor repair echelons as to requirements for repairs and as to supply of spare parts and other authorized items.

(c) Supervising repair operations and such unit replacement as may be authorized or required to meet special conditions.

(d) Making motor transport inspections required by existing current regulations and orders.

(e) Supervising operations and maintenance records and reports. Preparing records and reports on motor transport and forwarding those required by higher authority.

(f) Technically coordinating and consolidating requisitions for motor transport parts and supplies handled directly, or through the regimental, or similar supply officer. Supervising the receipt and distribution of these motor transport supplies within the regiment.

(g) Recording funds allotted or credits established for motor transport procurement for the regiment and the expenditures of such funds. Prorating any budget allowance provided for cleaning and preserving material and for the parts and supplies required by current regulations and approved by the regimental or similar organizational commander.

(h) Preventing the hoarding of motor transport parts and supplies by one or more batteries, companies, or troops to the detriment of others, and to the detriment of the service as a whole.

(i) Maintaining contact with all motor operation and maintenance activities within the regiment and with all maintenance establishments of the higher echelons to which the regiment has been assigned for the performance of third and fourth echelon repairs.

(j) Supervising motor transport schools within the regiment.

(k) Assisting the regimental commander in making command inspections.

(l) Working out the details on use and movement of vehicles of the regiment, coordinating all phases, including road circulation and traffic control, especially when operating under field conditions.

(m) Furnishing information to all subordinate units as to the location of the regimental or similar organization repair facilities in the field.

(n) In time of peace he makes suitable arrangements for repairing or salvaging vehicles on the march so damaged that towing is not practicable. He directs the transfer of loads from damaged vehicles and gives instructions to the personnel of these vehicles left behind during a march. In time of war he must make arrangements for immediate repair or abandonment of unserviceable vehicles when towing is not practicable giving proper instructions to expedite any roadside repair or rescue work.

(o) Supervising the examination of driver candidates and the issuing of War Department, Q.M.C. Form No. 228 (U.S. Army Motor Vehicle Operator's Permit).

(p) Preparing maintenance guides for subordinate units under his technical supervision and enforcing the use of these guides as well as the use of vehicle manufacturer's manuals within the regiment. Lubrication guides will be based upon the sources of lubrication instructions described in paragraph 225.

(q) Informing his immediate superior as to the efficient operation and maintenance of vehicles within the regiment or similar organization.

(r) Insuring that pertinent information contained in motor transport technical service bulletins and other official orders and regulations reaches all motor transport personnel of the regiment.

(s) Making frequent visits to operating and maintenance activities of the organization, rendering necessary assistance and advice.

(t) Organizing and supervising vehicle servicing, cleaning, maintenance and repair work.

(u) Watching lubrication activities and checking the type and kind of lubricants used. Extreme care must be exercised in keeping all lubricants clean and also the places where they are stored or kept.

(v) Eliminating all fire hazards.

(w) Observing drivers actually operating vehicles.

c. Truckmaster.—The truckmaster of a truck company and similar organizations, acting as first sergeant, is the intermediary between the company commander and the enlisted men of the organization. He also acts as the direct supervisor of motor transport operation, assisting the company commander in coordinating and controlling such activities. In some instances, especially in organizations having two or more interrelated functions, such as a field artillery battery, signal corps company, or mechanized cavalry troop, the first sergeant essentially assists the commander in the performance of the battery's or troop's combat mission and the motor sergeant then acts as truckmaster. The combined duties of a motor sergeant, as a truckmaster and as a chief mechanic, are shown in *e* below.

d. Motor sergeant.—The motor sergeant, in smaller organizations, can be considered as a combination truckmaster and chief mechanic. He should be selected for his technical knowledge, his mechanical ability and his aptitude for organizing and supervising. He should be well versed in field expedients and in the methods used to get vehicles through when they are stalled or when the going is bad.

(1) As truckmaster, his duties include—

(a) Principal assistant to the motor officer.

(b) Direct supervision of the vehicle motor park.

(c) Assisting, when required, in making inspections.

(d) Supervising and checking vehicle operation.

(e) Reporting evidence of neglect, abuse or carelessness to his superior officer.

(f) Supervising, through subordinate noncommissioned officers, all personnel assigned to motor transport duties.

(g) Keeping or supervising the recording of vehicle operation, fuel and oil used and supplies (through the supply sergeant and clerk).

(2) As chief mechanic, his duties include—

(a) Supervision of mechanics and their work.

(b) Enforcement of scheduled maintenance work.

(c) Supervision and checking of adjustments and repairs.

(d) Observing vehicle operation on the march and taking prompt corrective action when necessary.

(e) Supervising the rescue or removal of stalled and disabled vehicles.

(f) Checking, or requiring mechanics to check, all vehicles during any march halt and upon completion of the day's run. Particular attention should be paid to excessively heated parts (gears, wheel bearings, engines, brakes, and the like).

(g) Supervising starting of vehicle engines for prompt starting, proper warming up and for continued operation.

(h) Riding, usually, at the tail of the column as a part of the maintenance group.

(i) Allotting work to mechanics and inspecting their work during actual performance and when it is completed.

(j) Diagnosing mechanical failures and when necessary giving mechanics instruction as to proper corrective action.

(k) Making prescribed records and reports on scheduled preventive maintenance, servicing and repair work satisfactorily completed.

(l) Coordinating the technical phases of motor supply with motor maintenance activities.

(m) Establishing, in the absence of the regimental motor officer and any commissioned assistants, the maintenance set-up in the field and notifying all concerned of its location.

e. Chief mechanic.—The chief mechanic is the technical supervisor of the maintenance work of the organization. His duties are detailed in *d*(2) above.

f. Mechanics.—(1) Mechanics are detailed to organizations in accordance with Tables of Organization based on the number of vehicles to be maintained and the type of repair work to be done. For obvious reasons, they should be the best qualified mechanics in the regiment or similar organization.

(2) Mechanics make necessary repairs and adjustments under the direction of the motor sergeant or the chief mechanic.

(3) They perform scheduled preventive maintenance work, where specialized technical knowledge is a requisite to its proper performance.

(4) They observe vehicles during a march for signs of probable failures or defects.

(5) They assist section chiefs and squad leaders, when detailed, in making adjustments and in servicing vehicles.

(6) Mechanics usually ride on the march with the motor maintenance group.

g. Chief of sections and squad leaders.—These noncommissioned officers supervise and control their respective sections and/or squads to coordinate all motor transport activities within their groups and as part of the entire organization. They should see that all instructions on cleaning, tightening, servicing, and lubricating vehicles of their groups are complied with. They control the march of their sections and squads as to gear selections, distances, safety, operating speeds, and similar matters. Their duties include—

(1) Responsibility for supervising and directing driver (first echelon) maintenance.

(2) Prompt reporting of vehicle defects and failures to the truckmaster, the chief mechanic or motor sergeant, as may be required.

(3) Responsibility for checking the supply of gasoline, oil, water, and other supplies required for vehicle operations.

(4) Riding, usually, in the first vehicle of their section or squad.

h. Other personnel.—Drivers, assistant drivers and other personnel of motorized and mechanized organizations perform duties as indicated by their designation or as directed by the commissioned and noncommissioned officers over them.

■ 209. SUPPLY.—*a. Unit supply officer.*—The regimental or similar unit supply officer is usually charged with procuring, requisitioning and issuing fuel, lubricants, antifreeze, cleaning and preserving supplies, and similar motor transport items required by the batteries, companies or troops. In preparing requisitions and whenever otherwise required, he should utilize the technical experience and knowledge of the motor officer and his assistants, especially as to kind, type and quality, even to quantity, of motor supplies needed. The responsibility of the supply officer for such supply activities in no way changes those of the motor officer.

b. Tools and equipment.—(1) Tables of Basic Allowances prescribe the authorized allowance of tools and equipment for all echelons of maintenance, including the first and second (organizational) echelons.

(2) Each general motor mechanic authorized in Tables of Organization is allowed a "motor vehicle mechanic's" set of about 50 hand tools; included are a tool bag (box end, engineer); pipe, socket and crescent wrenches; hammers, punches, files, drifts, screw drivers, thickness gages, chisels and pliers.

These sets are issued individually on memorandum receipt. As a rule, the mechanic carries his set of tools with him wherever he is on duty.

(3) In addition to these motor vehicle mechanic's tool sets, special tools or kits for ignition, carburetor, brake and other repairs or maintenance work demanding them, may be issued.

(4) Depending upon the number of motor vehicles in its fleet, organizations performing first and second echelon repairs are authorized to use Unit Set No. 1 (for 20 to 30 or less vehicles) and Unit Set No. 2 (for fleets of about 60 vehicles). To augment these sets the following additional equipment when authorized may be furnished organizations:

- Unit set No. 3 (air equipment set).
- Unit set No. 4 (block and tackle set).
- Unit set No. 5 (welding equipment set).
- Unit set No. 6 (electric generator set).
- Unit set No. 7 (wrecking set).

These are essentially intended for field service but may also be used for maintenance work in garrison.

(5) One or more mechanics or repair trucks are authorized for organizations to carry the mechanics, the tools and equipment, and the parts and other supplies. If Unit set No. 7 (wrecking set) is authorized, an extra vehicle is required as a wrecker.

c. Spare parts and supplies.—(1) To prevent their hoarding, dispersion or dissipation, the stock of spare subassemblies, units, parts and supplies, in organizational maintenance echelons (first and second) is generally limited to that required for prompt and immediate repairs and for other necessary maintenance functions. The stock required will vary with the number, makes, types and age of vehicles, as with the efficiency of personnel and of such operating conditions as cold, dust, sand, mud and hilly, or poor terrain. As a rule, the following items are stocked in organizational maintenance echelons:

Spark plugs	Electric wiring
Condensers	Caps (hub, gas tank, etc.)
Fuzes	Nuts
Lamps (light bulbs)	Cotter keys
Fan belts	

Ignition and battery	Fittings
cables	Packing
Hose and clamps	Bolts
Gaskets	Washers
Gas and oil lines	Screws

The above list is not all inclusive but includes items normally known as "Parts common" or as "High mortality parts."

(2) The bulk of these supplies is carried within the regimental motor maintenance section, platoon, or similar group.

(3) Unserviceable units are replaced as soon as possible by serviceable ones. The unserviceable units should be sent to the third (or fourth) echelon for exchange; for repair and return; for repair and stock; or for disposition by action of an inspector or a surveying officer.

SECTION III

ECHELONS OF MAINTENANCE

■ 210. **FIRST ECHELON.**—This echelon performs preventive maintenance and is the principal factor upon which the life of motor vehicles depends. The driver and assistant driver are directly responsible for the performance of the duties and tasks included in this echelon. (See sec. III, ch. 2, for details.)

■ 211. **SECOND ECHELON.**—*a. General.*—(1) (a) This echelon essentially performs preventive maintenance. By scheduled and periodic inspections made in accordance with the principles prescribed herein, it detects minor incipient defects and corrects them promptly and properly. It makes such repairs and such unit replacements as are possible within the limits of time, facilities, and technical ability of the available personnel.

(b) When vehicles are pooled or are in one organization, such as a truck company, a signal company or similar motorized organization, the first and all of the second echelon functions are combined under the responsible unit commander. On the other hand, when a company, battery, troop, or similar organization is with its regiment or its battalion, the second echelon functions may be decentralized and divided between the smaller organization and its parent unit. These

smaller organizations, to which vehicles have been assigned, are responsible for all first echelon (drivers') maintenance and for certain second echelon duties that may be authorized. These latter responsibilities are limited as a rule, by tools and equipment, spare parts and the ability and capacity of the mechanics available to the smaller organization.

(c) The regiment is essentially a basic second echelon maintenance unit; the same is often true of the battalion and the squadron. With its organized maintenance section, platoon or company, it performs the repair operations requiring a greater degree of skill than is ordinarily available to the smaller units, and has a larger and more specialized variety of tools. Under normal conditions, it is the point of contact between the organizational echelons and the higher (service) echelons. It must often make decisions as to what repairs can be made within the regiment, battalion, or squadron and what work must be passed along to the nearest higher available echelon.

(d) The maintenance functions of this echelon may be subdivided into scheduled maintenance and operating (or march) maintenance.

(2) (a) Scheduled maintenance is based on both time and mileage. This calls for daily maintenance, monthly or 1,000-mile maintenance, 6 months or 6,000-mile maintenance, and seasonal maintenance, such as spring and fall when vehicles are prepared to meet the different operating conditions of summer and winter. These scheduled maintenance duties include both inspection and the necessary repairs and adjustments. Mechanics will perform the major portion of this work, but the motor sergeant or chief mechanic should closely supervise their work and may perform certain of the duties. As a matter of instruction, the driver of a vehicle should, when practicable, be an assistant whenever his vehicle is undergoing scheduled maintenance.

(b) It should be distinctly understood that preventive maintenance of a mechanical nature must be placed on a strictly mileage basis to be effective. However, in the case of some units of the tank, such as the engine, the check is made on an hourly basis. When a vehicle has been operated a certain number of miles certain checks and adjustments should be made. It is vital that the collection of machinery and mechanical devices that go to make up the motor vehicle

be inspected at given mileage periods, checked and adjusted where necessary. Normally nothing should be permitted to interfere with these inspections.

(c) If vehicles are operated daily there should be a daily visual check by second echelon personnel to cover such things as oil, water or gasoline leaks, obvious damage to body or running gear, conditions of tires, etc. This should be done in all cases after the end of the day's operation and in addition to the first echelon inspection made by the driver. It should be made as an assurance that the vehicle will operate, as a safety precaution, and to minimize road hazards to life and limb as an incident to defects in the vehicle.

b. Monthly (1,000-mile) maintenance operation.—This maintenance operation is normally performed by the company, battery, or similar unit mechanics under the supervision of the motor sergeant. A record is made to show the defects that could not be corrected, the time of accomplishment, the mechanic who performed the operation, and the officer who made the maintenance inspection. This record should be retained until the semiannual (6,000-mile) maintenance operations and technical inspection, at which time it may be disposed of as the unit commander sees fit. Pertinent data from the record are entered in the vehicle service record. A guide for this maintenance, which should be modified as necessary for a particular type of vehicle, follows. Tolerances and clearances might well be added. Items marked with an asterisk (*) may require tools and parts not available or authorized, in which case the defect should be corrected by the next higher echelon:

(1) *Road test.*

- (a) 1. Bring engine to operating temperature and examine for smoke or fumes. Examine condition of oil on measuring stick. Observe any evidences of blow-by or leaks.
2. Test horns, lights, windshield wiper, and other safety devices.

(b) Drive vehicle.

1. Test for proper steering.
2. Observe engine for power delivery, acceleration, and unusual noises.
3. Test clutch action. Stop and investigate unusual noises.

4. Test gear sets and final drives for ease of shifting and unusual noises.
5. Test brakes for equalization, stopping distance, pedal travel, and pedal "feel."
6. Observe action of instruments on dash.
7. Observe the final drive and power transmission units while another person drives or while the vehicle is blocked up with the wheels off the floor. Note any overheating of units.

(c) Check lubrication levels after return to motor park.

(2) *Maintenance operations, general.*—(a) Clean and tighten storage battery, terminals, and carrier bolts. Test battery and refill to proper level.

(b) Tighten body bolts, fenders, running boards, splash pan joints, bumpers, brush guards, head lamp brackets, mirrors, tow hooks, pintles, body parts, radiator shell, and hardware.

* (c) Repair body injuries.

(d) Replace unserviceable instruments or safety devices.

(e) Adjust lights.

(3) *Wheels, brakes, and springs.*—* (a) Replace worn brake lining.

(b) Correct overlubrication or leakage of lubricant.

(c) Remove looseness or bind from wheel bearings.

(d) Tighten wheel stud nuts.

(e) Correct any leaks in hydraulic or air brake system.

(f) Fill master cylinder to proper level.

(g) Centralize and adjust brakes.

(h) Replace unserviceable shock absorbers and linkage; replenish fluid.

(i) Repair broken or loose spring hold-down bolts, rebound clips, and center bolts. Tighten loose shackle bolts.

(j) Correct any malfunctioning of the brake system.

(4) *Steering mechanism.*—(a) Remove by adjustment or repair any excessive play in—

1. Steering knuckle bearings.

2. Tie rod ends.

*3. Bushings.

4. King pin wedge bolts.

5. Drag link or connecting link.

6. Pitman arm on sector shaft.

7. Steering gear.

(b) Tighten attachment of steering mechanism to frame, and of steering column to body.

(c) Replace any excessively worn or bent parts.

(d) Tighten, replace, or properly secure all lock washers, cotter keys, nuts, and similar items.

*(e) Adjust wheel stops when turning radius is incorrect. (Note any wear on drag link.)

(f) Lubricate entire mechanism while front wheels are off the floor. Turn wheels from side to side to insure distribution of lubricant and to ascertain whether or not the entire mechanism works freely.

(5) *Driving axles.*—(a) Tighten loose driving flange nuts and cap screws.

(b) Tighten and properly secure all assembly, pinion carrier, cover plate, spring seat, and other bolts and nuts.

*(c) Correct any leakage of lubricant.

*(d) Remove any excessive play or backlash.

(6) *Clutch, transmission, transfer case, propeller shafts, and universal joints.*—(a) Adjust incorrect clutch free travel and floor clearance.

*(b) Repair defective reverse shifter stop, and malfunctioning shifter mechanisms.

(c) Tighten all loose bolts and nuts, assembly support, carrier, and cover plate.

*(d) Correct any leakage of lubricant.

(e) Correct misalignment of universal joints.

*(f) Repair all fractures.

*(g) Replace excessively worn spline and universal joints.

*(h) Repair all evidences of slackness, looseness, or leakage.

(i) Open clutch housing drain vent.

(j) Repair or replace muffler or tail pipe.

(7) *Cooling system.*—(a) Tighten radiator supports, braces, and attachment of shell to core.

(b) Adjust fit of hood on shell and fit of hood locks.

(c) Replace unserviceable hose and hose clamps.

*(d) Correct all evidences of water leakage.

(e) Adjust incorrect fan-belt tension; replace unserviceable fan belt.

(8) *Fuel system.*—(a) Clean dirty sediment bowls.

*(b) Correct any leakage in or around the fuel pump.

(c) Tighten connections; repair or replace leaking lines.

- **(d)* Correct any malfunctioning of fuel pump.
- (9) Engine.—(a)* Service all air filters; replace oil filter if required.
- (b)* Tighten engine mountings, flywheel housing, oil pan, flywheel cover, timing-case cover, manifolds, accessory attachments, and other bolts and nuts.
- **(c)* Correct all breakage, cracks, or leaks.
- (d)* Set manifold heat valve to seasonal adjustment.
- **(e)* Repair unserviceable breaker points.
- (f)* Replace all damaged wiring.
- **(g)* Correct malfunctioning generator or starter.
- **(h)* Correct generator output.
- (i)* Adjust noisy valves.
- **(j)* If on the road test any missing occurs, the entire ignition system should be carefully checked and spark plugs removed, examined, cleaned, reset, and serviceable ones reinstalled.
- **(k)* Remove causes of other knocks, noises, and unsatisfactory engine performance. (Vacuum gage is valuable for diagnosis of troubles.)
- (l)* Repair looseness in any controls.
- (10) Road test.—*Check repairs.
- (11) Record.—*Prepare a record as follows:
- (a) Defects not corrected.*

<i>Unit</i>	<i>Defect</i>
-----	-----
-----	-----
-----	-----

(b) Mechanic's and motor sergeant's certificate.

I have performed the maintenance operations as outlined in the guide for monthly (1,000-mile) maintenance operations, and so far as can be determined this vehicle can be expected to give 30 days, or 1,000 miles, of satisfactory service, except as indicated under defects.

Date ----- Signature ----- Signature -----
(Mechanic) (Motor sergeant)

(c) Maintenance inspection certificate.

I certify that I have performed the maintenance inspection on this vehicle as required by AR 850-15 and that it can be expected to give 30 days or 1,000 miles of satisfactory service.

Date ----- Signature -----
(Motor officer)

c. *Semiannual (6,000-mile) maintenance operations.*—These maintenance operations are normally performed by the regimental second echelon of maintenance. Under extremely severe operating conditions certain items may have to be checked every 2 or 3 months. An instructional guide similar to that used for the monthly (1,000-mile) maintenance operations should be drawn up. These maintenance operations differ from the monthly operations in that all accessory units and some other parts are disassembled, cleaned, inspected, and lubricated. They are then repaired or exchanged if necessary. Semiannual (6,000-mile) maintenance operations are thus more complete than are those performed monthly or every 1,000 miles, and should assure reasonable vehicle service if the monthly (1,000-mile) maintenance operations are carefully performed. If a shop card is not made out to show the repairs, the mechanic, the items not corrected, and the completion of the inspection, a record similar to that used in conjunction with the monthly (1,000-mile) maintenance operations should be prepared and retained until after the technical inspection. Maintenance operations that should normally be included in the 6-month (6,000-mile) service are—

(1) *Records* to include inspection of vehicle repair and operating records for the past 6 months (6,000 miles), followed by a road test similar to the monthly (1,000-mile) maintenance.

(2) *Engine tune-up* to include check of oil and air filters, a vacuum and compression test, cleaning of oil pan and interior of engine, adjustment of valves, adjustment of spark plugs, reconditioning of ignition wiring, generator servicing, starter servicing, ignition servicing, carburetor servicing, and check of tightness and serviceability of all parts and accessories.

(3) *Fuel system* to include examination and servicing of fuel pump, gas lines, carburetor, and tank.

(4) *Cooling system* to include radiator service and check of thermostat, fan, belt, and water pump.

(5) *Instruments and electrical systems* to include check, service, or replacement of horn, lights, wiring, windshield wiper, and dash instruments.

(6) *Clutch, transmission, and transfer case* to include clutch travel and floor clearance, reverse shifter stop, trans-

mission and transfer case supports, grease seals, tightness, and lubrication.

(7) *Propeller shafts and universal joints* to include slackness, free movement of spline joints, grease seals, and lubrication.

(8) *Driving axles* to include backlash, inspection, lubrication, and adjustment of wheel bearings, spring clips, spring hold-down bolts, spring shackles, driving flanges, leaks, grease seals, and lubrication.

(9) *Steering mechanism* to include attachment of steering mechanism and column, pitman arm, play in steering mechanism, steering linkage, steering stops, turning angle of front-drive axle, and lubrication.

(10) *Front end* to include spring hold-down bolts, rebound clips, shackles, shock absorbers, lubrication and adjustment of wheel bearings, tie rods, and tires for wear and alignment.

(11) *Wheels and brakes* to include hub bolts, grease seals, brake lining, brake linkage and lines, and brake cylinders.

(12) *General* to include storage battery, body and attachments, curtains, muffler, and tail pipe.

(13) *Engine check* by bringing engine up to operating temperature and checking results of engine tune-up for quietness; idling speed; acceleration; and leaks in carburetor, fuel pump, gas lines, cooling system, oil pressure lines, and oil seals.

(14) *Road test.*

(15) *Record of operation.*

d. Seasonal maintenance.—As vehicles are prepared for the different operating conditions of summer and winter, opportunity is afforded the following (to be done during a service operation if possible):

(1) Remove all wheels and examine brake drums, linings, and bearings. Repack bearings with proper grade of wheel bearing lubricant and adjust the bearings.

(2) Drain transmission, also transfer case and power to take-off unit, check for leaks, loose hanger bolts, misaligned shafts; note tooth wear; refill with proper winter (or summer) lubricant (EP lubricant if required).

(3) Drain differentials, check for backlash and proper tooth engagement; note tooth wear, leaks; refill with proper winter (or summer) lubricant (EP lubricant if required).

(4) Carburetor, clean and adjust.

(5) Drain, flush, and thoroughly clean engine cooling systems; replace and tighten hose connections if required; refill with antifreeze (if for freezing weather).

(6) Liquid cooled engine operating temperatures should be maintained at 140° F to 160° F in cold weather. This may be accomplished by keeping thermostats in workable condition, closing louvres and partially covering radiator.

e. Lubrication of vehicles.—This operation is usually performed by the first echelon but special service conditions may make it necessary to assign this responsibility to technical personnel of the second echelon to assure correct lubrication and to meet unusual requirements. TM 10-540 contains detailed information on general application of lubricants. Specific information on a particular make or model of vehicle can be found in the vehicle manufacturer's operation and maintenance manual or in the vehicle's service record (W. D., Q. M. C. Form No. 248), and in technical manual for that vehicle. In the case of ordnance vehicles, general information on lubrication is found in OFSB (6-series).

■ 212. COMPANY OR BATTERY AND REGIMENTAL SECOND ECHELON REPAIRS.—The following examples do not include all the operations performed but show some of the common ones:

a. Company or battery.—(1) *Adjustments.*—Wheel bearings, pedal clearances, steering gear and linkage, fan belt, water pump, spring shackles, and lights.

(2) *Replacements.*—Carburetor, generator, distributor cap and rotor, fuel pumps, batteries and cables, manifolds, instruments and switches, oil lines and filters, and brake shoes.

b. Regiment or battalion.—(1) *Adjustments.*—Steering geometry, voltage regulator, carburetors, generators, valve tappets and timing.

(2) *Replacements.*—Tie rods, distributor points, valve springs, carburetors, thermostats, fuel pump diaphragms, and governors.

■ 213. THIRD ECHELON.—*a.* The third echelon of maintenance is performed by mobile organizations of the Quartermaster Corps and by the Ordnance Department for combat vehicles and others in an emergency. Maintenance operations include the following:

(1) Supplies units and parts to the second echelon.

(2) Makes unit replacements beyond the scope of the second echelon.

(3) Makes repairs involving the use of mobile shop equipment.

(4) Evacuates to the fourth echelon shops those vehicles and assemblies which require repairs beyond the scope of the third echelon.

(5) Makes technical inspections.

b. The work of this third echelon within a division is performed by the maintenance platoon (company) (troop) of divisional quartermaster troops or by a quartermaster company (troop) of a light maintenance battalion, attached from army or army corps.

(1) This echelon is provided to serve a number of organizations in which the first and second echelons (organizational) are functioning. It is charged with the technical supervision of the work of the lower echelons, as provided in current orders and regulations or by higher authority.

(2) Light maintenance units (third echelon) are organized and equipped to provide immediate decentralized support to lower organizational echelons requiring it, especially under field service conditions.

c. Ordnance third echelon maintenance will be done to a very limited extent by the ordnance section of division special troops. The major portion of these repairs and replacements will be made by the ordnance battalion, maintenance, corps special troops; and ordnance battalion, maintenance and supply, army troops. The ordnance maintenance section of the division is a small detachment carrying a limited load of spare parts. Its main duty is to advise the using arms on the maintenance of ordnance vehicles or, when necessary, quartermaster vehicles.

d. The following indicates the type and nature of repairs to be performed by the third echelon of maintenance:

(1) Minor repairs to bodies.

(2) Repair or replace radiator.

(3) Install complete assemblies such as engines, transmissions, axles, and the like, or replace subassemblies and small items such as cylinder heads, carburetor, oil pump, oil pan, fan assembly, generator, starting motor, oil pressure

gage, ignition units and others, when inspection discloses that the old one is in need of repair or replacement.

- (4) Repair hoods.
- (5) Repair bumpers.
- (6) Adjust or replace shock absorbers.
- (7) Replace clutch.
- (8) Replace transmission.
- (9) Replace inclosed propeller shaft and universal joints.
- (10) Rebush or replace front axle assembly or parts thereof.
- (11) Replace and adjust rear axle assembly or parts thereof.
- (12) Repair sheet metal.
- (13) Replace steering gear or parts thereof.
- (14) Repair oil pump.
- (15) Rebush or replace spring shackles.
- (16) Replace and adjust wheel assembly or bearings.
- (17) Repair fenders.
- (18) Repair storage battery.
- (19) All electric and gas welding (oxygen-acetylene).
- (20) Repair troop seats.

e. No attempt is made in the above to indicate in detail all of the operations which may be performed in the third echelon. It must be remembered that parts or subassemblies should be installed only when the repair is economical and necessary for proper vehicle performance. Whenever replacement of a complete major unit is indicated, such as an engine, transmission, front or rear axle assembly, no attempt should be made by the third echelon organization to overhaul the assembly or unit removed from the vehicle.

f. The main objective of the third echelon is to return the vehicle to service in a good operating condition in the shortest possible time. Normally this can be done best by replacement of unit assemblies, subassemblies, or minor repairs not involving complete tear-down of a unit. If the third echelon activity oversteps its bounds and attempts to do the work that properly belongs to the fourth echelon, it will probably become swamped with work and the entire fleet or fleets of vehicles it is serving will suffer from the resulting delays. Consequently, third echelon maintenance units are equipped only with the tools, mobile equipment, and motor mainte-

nance supplies that will enable them to perform the functions of unit replacement efficiently by limiting their capacity to work that can be done within reasonably short periods of time.

g. The third echelon will ship unserviceable units removed from vehicles to the proper fourth echelon shop for rebuild and replacement, when necessary. These unserviceable units when shipped must be complete with all subassemblies and parts; that is, an engine must not be shipped without its carburetor, fan, ignition unit, air cleaner, oil filter, and the like.

h. The third echelon, as indicated above, maintains stock on hand at a predetermined level so it can immediately meet all demands made by the lower echelons. This stock includes spare parts, unit assemblies, and common parts that are most generally used. The amount and kind of stocks on hand must always be based on the make, type, and model of vehicles in the operating fleet of the regiments and similar organizations served by the particular third echelon activities. The actual quantities kept on hand are determined on the basis of experience tables covering the vehicles to be maintained and anticipated consumption of the higher mortality parts.

■ 214. FOURTH ECHELON.—*a.* The fourth echelon of maintenance is normally a fixed shop and a supply depot. Under some circumstances this echelon may be a semimobile establishment. It is organized to supply units, parts, and specialized automotive items to all lower echelons (first to third inclusive), and in some instances to other fourth echelon activities. It utilizes the services of the most skilled automotive mechanics and trade specialists available for general overhaul and reclamation of units and vehicles involving major repairs and manufacture of parts. It also is organized to perform the maintenance functions normally done by the lower echelons (first to third) when conditions make it necessary.

b. The functions of the fourth echelon are performed by quartermaster heavy maintenance regiments, battalions, or companies. These organizations operate according to the several automotive maintenance classifications and the technical qualifications of the specialists assigned to them. The

quartermaster heavy maintenance regiment consists of a headquarters and headquarters' detachment and three battalions. Each battalion consists of a battalion headquarters and headquarters' detachment, a motor transport depot company, and three heavy maintenance companies. The heavy maintenance company consists of a company headquarters, a shop headquarters and supply platoon, and four maintenance platoons designated vehicle assembly, heavy units, power plant, and allied trades.

c. Fourth echelon maintenance activities are essentially based on mass production methods to insure a prompt return of repaired units, assemblies, and subassemblies to depot stock so that they can be issued as required or returned to their proper organization when required. The same is generally true with regard to its reclamation and salvage activities. Special manufacturing and vehicle reconstruction work are performed in this echelon, whenever required to meet special conditions. Stocks are determined from experience tables based on parts mortality and are selected for the particular type of motor transport vehicles included in the organizations to be supplied.

(1) Supplies necessary for motor transport may be divided generally into three classes:

Operating supplies (fuel, lubricants, etc.).

Maintenance supplies (spare parts, replacement parts, etc.).

Cleaning and preserving materials.

Gasoline or other automotive fuels and lubricants will be handled in the field by quartermaster battalions (or companies), gasoline supply.

(2) The supply of maintenance items requires careful planning, prompt service, and strict economy, to insure efficient operation. Stocks of spare parts, assemblies, and units must be maintained in quantities necessary to meet replacement demands. The ordinary procedure requires that an unserviceable unit be replaced from stock and turned in for overhaul or salvage. For example, when a carburetor on a vehicle becomes unserviceable, the second echelon may replace it at once by a spare carburetor in stock and send the defective unit to the third echelon establishment in exchange for a serviceable one to replenish the stock. The actual repair

of the damaged item may be made in the third echelon or fourth echelon before it is returned to stock; if beyond repair, it is disposed of in accordance with existing orders. Constant watchfulness on the part of the responsible officers is necessary to insure that stocks of the echelons are kept to the prescribed limits. If the stocks become depleted, delays and an increase in the number of unserviceable vehicles on hand will result. On the other hand, if stocks are accumulated in unnecessary quantities in the lower echelons, it will result in excessive vehicle loads or in delaying or stopping the repair work of other organizations which cannot obtain the part due to "stock hoarding." Hoarding and accumulating of excessive stocks of supplies, especially in the lower echelons, should be discouraged and all efforts made to prevent such action.

■ 215. APPLICATION OF ECHELON SYSTEM OF MAINTENANCE TO THEATER OF OPERATIONS.—*a.* It should be noted under the military echelon system of maintenance that echelon repairs to vehicles and units are limited by the supplies, equipment, personnel, and time available. Thus, it may happen when conditions are favorable, that an unserviceable unit or vehicle ordinarily turned over to the fourth echelon for repair or reclamation by the third echelon may be actually repaired and returned to the using organization by the third echelon. When the third echelon shop has repairs beyond its capacity, it is often necessary that some of its third echelon work be evacuated to the fourth echelon shop. At other times and under favorable conditions, the second echelon may make third echelon repairs rather than evacuate the vehicle or assembly. These conditions illustrate the flexibility of the echelon system of maintenance.

b. Supply and evacuation.—The procedure governing supply in a theater of operations is that supplies must flow down through all four echelons of maintenance described in preceding paragraphs. Supplies in combat areas must always move forward from the rear (fourth echelon) to the front (first echelon). Each one of these echelons carries a stock of spare parts, the first may be limited to only a spark plug or a roll of tape. In addition the extent to which second echelon organizations carry spare parts is limited by current regulations and by the capacity of available vehicles for

carrying these units in addition to tools, spare parts, and motor supplies. While this latter restriction does not apply in post or garrison, it is a most vital consideration in field service.

SECTION IV

MARCH MAINTENANCE

■ 216. GENERAL.—Maintenance, while on a march, presents many special and difficult problems, although, in general, the principles already described apply. The speed maintained, especially on long marches, in a very short time causes disabled vehicles to become separated from their units by considerable distances. This must be considered in making decisions concerning the vehicles and any personnel left with them, especially on sections of road which will be needed for other marching groups or which will soon pass to the control of other military units. Personnel and maintenance facilities may become sufficiently separated from their respective units to endanger their return. Because of the unpredictable nature of marches near the enemy, and the ever present urgent need for transportation, every opportunity for motor maintenance should be used, even if it is only possible to make repairs to keep the vehicle moving and it is necessary to finish the work at some other time.

■ 217. MAINTENANCE PERSONNEL.—Where marches of tactical units are involved, each organization will have the maintenance personnel allowed by Tables of Organization. It is possible in special situations, that some third echelon personnel may be attached. Maintenance personnel of batteries, companies, or similar units normally ride at the tail of their respective units, while the regimental motor maintenance personnel ride at the tail of the regiment.

■ 218. EQUIPMENT, SPARE PARTS AND SPARE UNITS.—The repair equipment available consists of the tools and equipment allotted by the Table of Basic Allowances for each organization. The parts and units carried should be sufficient to cover all work that experience indicates will probably occur. Where small organizations such as batteries, companies, or similar organizations operate by themselves, a minimum of spare parts and units should be furnished from the regimental second echelon.

■ 219. REPAIR PROCEDURE.—*a.* During marches, roadside repairs to disabled vehicles are frequently temporary in character. The necessity for keeping the vehicles under control and moving to complete their assigned tasks, often requires hasty temporary repairs sufficient only to complete the trip. Upon reaching its destination or bivouac, the vehicle should be thoroughly repaired. When a vehicle drops out of its battery, company, or similar unit, the maintenance personnel at the tail of the unit should attempt to diagnose and correct the trouble quickly.

b. If the diagnosis shows that the vehicle only needs a minor repair, a mechanic with a kit of tools and spare parts may be dropped off with the vehicle. When the vehicle is carrying supplies and troops, or towing a gun, and doubt exists as to its probable repair in a reasonable time, its cargo or tow must be removed and loaded or attached to another vehicle. The driver must always remain with the vehicle, unless ordered by competent authority to abandon it. When a vehicle drops out, it should be driven, pushed, or towed well off to the right of the road, so that other vehicles may pass around without halting. If the vehicle is repaired by the mechanic who was dropped off, it resumes the march at the maximum authorized speed and rejoins the rear of the last unit that has passed, remaining there until the next halt. If march orders so permit, it then doubles the column and proceeds to join its organization. If the mechanic cannot complete the repairs, the vehicle should either be repaired or towed by the regimental motor maintenance personnel bringing up the rear of the march column.

c. (1) If the mechanic crew of the battery, company, or similar unit decides that immediate repair is not possible, the vehicle may be towed and repairs made later, or it may be abandoned to regimental motor maintenance or to a higher echelon. The decision in all cases is made by the motor officer, or, in his absence, by the motor sergeant or chief mechanic. This demands considerable practical knowledge and training. Under certain circumstances it is advisable to tow the vehicle until a more suitable place for making repairs can be located. Many considerations, such as type of repair, road, weather, enemy action, traffic conditions, and distance from bivouac, have a bearing on this decision. For example, the regimental motor maintenance organization

should tow a vehicle with a burned out bearing when only an hour or so from the bivouac. Yet, if the same failure should occur shortly after departure from a bivouac, or in the mountains with a heavy load, the repair should be made on the spot if the parts required are available.

(2) When repair personnel are working by the side of the road, individuals as guards, flags, signs, lights or flares should be put out as a warning to passing traffic unless the vehicle is completely off the road. At night, red lanterns should be used. Lighted warning signals, unless of the approved type, should not be used when "blackout" light restrictions are in effect.

(3) Whenever a battery, company, or similar unit maintenance crew stops to diagnose a vehicle that has fallen out, care must be exercised that the crew personnel does not become separated from their parent organization. If this happens, the unit then has no maintenance personnel to care for the remaining vehicles of the group. Maintenance personnel should normally be with the organization when it arrives in bivouac, to assist in inspecting, repairing, and servicing the vehicles of the organization.

■ 220. TOWING DISABLED VEHICLES.—Arrangements in any march column for towing disabled vehicles depend upon the type of vehicle, road conditions, type of march, and other considerations. Some vehicle or vehicles near the rear of each organization should be designated as spare and towing vehicles so that when a vehicle falls out, some vehicle near the rear of the march group will be available if towing is required. Such an arrangement prevents confusion and possible loss of a vehicle for the lack of a towing vehicle. If vehicles are not made available as spares and for towing purposes, the disabled vehicle must be repaired or abandoned with its cargo. Towing vehicles should be provided with tow bars, tow ropes, or tow chains.

■ 221. ABANDONING VEHICLES.—a. When vehicles on the march become disabled and for some reason are not towed or are not capable of being towed with vehicles within the organization, they may be abandoned either temporarily or permanently.

(1) When the abandonment is temporary, the driver and possibly a mechanic are left with the vehicle which must be

moved off the road. In the combat zone consideration must be given to the possibility of not recovering the personnel and facilities thus detached. If a gun prime mover fails, the gun should be coupled to any available vehicle and accompany its organization. Every effort should be made to remove to other vehicles all essential combat equipment prior to abandonment. A driver left with a vehicle awaiting maintenance or salvage personnel should be given explicit orders concerning the protection or removal of the load.

(2) If the abandonment is permanent, the proper steps should be taken to comply with orders covering such action. When vehicles are abandoned or left for the disposition by service echelon, the commander should obtain replacement as soon as possible. When operating units abandon vehicles, the supply service concerned should be furnished accurate reports as soon as practicable of the location and general conditions of such vehicles.

b. It is extremely important that highways be kept clear, consequently abandoned vehicles must be pushed well off the road.

SECTION V

LUBRICATION

■ 222. GENERAL.—a. Lubrication is an essential part of preventive maintenance. To a great extent it determines serviceability of parts and assemblies; it materially influences repair and operation costs; and it is one of the most important factors affecting dependable mobility and long and useful vehicle life. Training, supervision, supplies and equipment are required for the performance of correct lubrication.

b. Correct lubrication provides and maintains, under all conditions of operation, a suitable oil film between friction surfaces that require it.

c. Details and methods of lubrication are included in various manufacturers' manuals, in TM 10-540, in Technical Manuals covering individual vehicles, and in case of ordnance vehicles, in OFSB (6- series).

■ 223. METHODS.—a. Lubrication may be decentralized or centralized. In either case the unit commander must definitely fix responsibility. The motor officer, assisted by the

truckmaster, the motor sergeant, and/or the chief mechanic, prepares lubrication schedules, supervises lubrication and makes frequent inspections to assure himself that all vehicles are properly lubricated, using as guide information listed in paragraph 19c.

(1) *Decentralized lubrication.*—This method is particularly applicable to field service operations, and will give excellent results when personnel are properly trained and supervised, and lubrication schedules are carefully followed. Responsibility is divided as follows:

(a) The driver performs the prescribed first echelon lubrication functions. (See par. 22.)

(b) The mechanics lubricate gear cases, steering gear housing, wheel bearings, universal joints, starting motor, generator, distributor, clutch release bearing, water pump, fan, air cleaner, and other special items, also change crankcase oil.

(c) Squad leaders, chiefs of sections, motor sergeants, chief mechanics, and truckmasters are charged with direct supervision of lubrication activities in the organization. They should make frequent inspections to insure correct and scheduled lubrication.

(2) *Centralized lubrication.*—When this method is employed, all lubricating functions are carried on at a central point and drivers are relieved of all responsibility for lubrication except the replenishment of engine crankcase oil. When centralized lubrication is applied to a small fleet one qualified individual should be charged with responsibility for lubrication. When the fleet is too large to be lubricated correctly by one individual, assistants should be provided and responsibilities should be definite and fixed. Vehicles should be sent to the central place when lubrication is required and should be accompanied by the driver. The driver's services should be utilized to assist in and expedite the work. Centralized lubrication is not normally recommended for field service operations of combat organizations and of supply and service units in the combat area.

b. When motor vehicles are detached from their organizations so that they will miss their scheduled lubrication service, provision should be made for the performance of the lubrication functions. This should be accomplished in one of the following ways:

(1) Send qualified personnel and the necessary supplies and equipment with the vehicles.

(2) Arrange for the vehicles to be lubricated by the other organization.

(3) Provide the necessary supplies and equipment, and direct the driver to perform the lubrication.

c. During cross-country operations, involving low-gear operation, consideration should be given to more frequent oil change.

■ 224. SCHEDULES.—*a.* Lubrication schedules should be prepared for each make of vehicle assigned to an operating organization. When more than one type vehicle of the same make is assigned, usually one schedule can be devised which, with a few exceptions, should apply to all types of the same make. The schedule or chart furnished by the manufacturer should form the basis for organization lubrication schedules and should be modified in accordance with practical experience. When the manufacturer's or other approved recommendations are not available, schedules should be devised by experienced personnel and steps immediately taken to obtain approved recommendations. TM 10-540 can be used as a guide.

b. Lubrication periods recommended by the manufacturer are generally too infrequent to provide correct lubrication for military motor vehicles under hard field service conditions. They often should be modified to meet the operating conditions imposed by field service. In general, the chassis and slow moving parts should be lubricated, if practicable, every 15 days or 100 hours of vehicle operation; the crankcase oil should be checked frequently and oil changed after 500 to 1,000 miles of operation, especially if a vehicle is operated for considerable periods across country or in low gear. Extreme conditions of operation may necessitate more frequent changing of the oil. Winter operation, operating in dust, or sand-laden atmospheres, conditions which permit water to enter bearings and gear cases, may make more frequent oil changes and lubrication necessary. It is essential that the air cleaners be kept in perfect working order at all times. The gear lubricants should be checked weekly and changed seasonally, unless manufacturer recommends more frequent changes.

Supply of proper lubricants, properly trained personnel, energetic supervision, and strict application of lubrication schedules are all necessary to achieve correct lubrication.

■ 225. LUBRICANTS.—*a. General.*—Lubricants used on military motor vehicles should conform to the recommendations of vehicle manufacturers or of the supply services concerned. When no recommendations are furnished by the manufacturer or the supply service concerned and when a doubt exists, the selection and use of the proper lubricants should be based on the experience of technically qualified personnel. During field service it may be impossible to supply a complete assortment of lubricants which meet the above recommendations and it will be necessary to make the best use of those available.

b. Types and uses.—Correct lubrication of motor vehicles requires the use of several types of lubricants and the application of each type in accordance with a lubrication schedule. Detailed instructions as to types of lubricants and their general use are shown in TM 10-540. In the case of ordnance vehicles, information is given in OFSB (6-series) and in Technical Manuals covering specific vehicles. General instructions as to types and uses are as follows:

(1) *Lubricating oils.*—Lubricating oils used on military motor vehicles are exclusively mineral oils obtained by distilling crude petroleum oils. They are characterized by physical properties such as viscosity, viscosity index, flash point, and pour point. They should be used in accordance with the approved recommendations. In general, oils are employed to lubricate engine bearings; starting motors; generators; slow-moving surfaces such as brake pedal pivots and brake linkage, door hinges, and locks; some fan bearings; some water pumps; and some transmissions. Different makes of oils should not be mixed.

(2) *Gear lubricants.*—Gear lubricants are heavy bodied oils, pure mineral oil or pure mineral oil to which materials have been added, used for the lubrication of parts where a strong oil film is required. In general, they are employed for the lubrication of final drives and differentials, transmissions, auxiliary transmissions, transfers, steering gear housings, some wheel bearings, and some universal joints. Approved

recommendations should be followed. The following types of gear lubricants are available:

(a) *Fluid gear oils*.—These are pure mineral oils. They are heavier in body than oils used in the engine crankcase, but are usually not so highly refined. These oils are comparable to steam cylinder oil, a dark-colored, heavy-body oil. They are used for the lubrication of gear trains, steering gears, and universal joints where pressures and temperatures are moderate.

(b) *Compound gear lubricants*.—These are blends of mineral oil and soap. The soap, usually a soda type, acts as a filler, but does not increase the lubricating properties of the oil. Normally, compounded gear lubricants are used instead of fluid gear oils when tooth wear has taken place or when the gear housings will not retain a fluid oil.

(c) *Extreme pressure (EP) lubricants and hypoid lubricants*.—These lubricants are mineral oils combined with certain soaps and/or chemicals to increase the oil film strength. They are required for the proper lubrication of final drives where high-unit pressures, combined with severe squeezing action, prevail. A pure mineral oil or a compounded gear lubricant does not provide an oil film strong enough to prevent metal-to-metal contact under these operating conditions. Hypoid lubricants must be used to lubricate hypoid final drives. Different types of gear lubricants, different makes of EP, or different makes of hypoid lubricants should not be mixed. EP lubricants and hypoid lubricants, being chemically active, are harmful to some metals and are susceptible to chemical changes during use; therefore they should be used in accordance with accepted practice.

(3) *Greases*.—Greases are usually made by compounding mineral oil with a soap. The load-carrying properties of greases, except graphite grease, are determined by the oil used in compounding the grease. Greases are used to lubricate surfaces where pure mineral oil or gear lubricants cannot be retained. The following types of greases are used:

(a) *Chassis lubricant*.—Chassis lubricant or pressure gun grease is usually made by compounding a light oil with a soap. It is available in a variety of consistencies. The consistency may be determined by either the oil or the soap, or both, used in compounding and should not be used as an index to the lubricating and load-carrying properties of the grease.

Consistency affects ease and manner of application. Chassis lubricants have a natural tendency to spread readily over the bearing surfaces, to cling to them, and to resist the action of water. They are used at practically all points on a motor vehicle that are equipped with pressure grease fittings, with a few exceptions such as water pumps, universal joints, and wheel bearings.

(b) *Cup grease*.—Cup grease has a higher consistency than chassis lubricant but is not heat resistant. Since the development of special greases there is little or no use for cup grease for the lubrication of motor vehicles.

(c) *Water-pump grease*.—Water-pump grease is usually made by mixing tallow with cup grease. It is not readily soluble in water and has a melting point considerably higher than the boiling point of water. This grease was especially developed for water pump with gland packings.

(d) *Sodium soap (fiber) greases*.—Mineral oil combined with sodium soap produces greases known as fiber or fibrous greases. These greases are stringy or fibrous in nature, but there is no fibrous material actually present in the grease. Fiber greases have a high melting point and a very strong tendency to cling to bearing surfaces, making them particularly suitable for the lubrication of parts and assemblies where centrifugal force tends to throw out the lubricant. They are usually soluble in water, thus limiting their use to parts or assemblies that are practically free from the action of water. The general uses of fiber grease are universal joints, wheel bearings, clutch-release bearings, and some drive axle universal joints.

(4) *Miscellaneous lubricants and fluids*.—(a) *Spring lubricant*.—Graphite grease, a mixture of grease and graphite, is generally used for the lubrication of spring leaves. It is not to be used for general lubrication purposes.

(b) *Penetrating oil*.—This oil is used principally to get into places that have become very dry or rusty, such as brake linkage and nuts or bolts that cannot be loosened or tightened with a reasonable amount of force.

(c) *Petrolatum or vaseline*.—Petrolatum or vaseline is used to coat battery terminals and connections to reduce corrosion. It is also used to lubricate the fiber block on the movable breaker point arm in the distributor housing.

(d) *Kerosene*.—Kerosene may be used to thin engine lubricating oil in very cold weather. Approved recommendations should be followed closely when it is necessary to resort to this practice.

(e) *Cleaning solvent*.—Cleaning solvent is a compound fluid used for washing engines, parts and assemblies. It is not highly inflammable; however, it should be employed with caution when used for cleaning hot engines. When cleaning solvent is not available kerosene may be used.

(f) *Alcohol*.—Hydraulic-brake parts should be cleaned with denatured alcohol. Gasoline, kerosene, cleaning solvents, and oils are harmful to these parts and must not be used for this cleaning.

■ 226. MEANS OF APPLICATION.—Lubricants are applied to the motor vehicle by employing the equipment provided by Tables of Basic Allowance and in accordance with vehicle manufacturer's manuals or with TM 10-540.

■ 227. RECORDS.—A complete record of lubrication should be kept. Responsible personnel should report when lubrication duties have been completed in order that proper entries may be made.

SECTION VI

INSPECTIONS

■ 228. GENERAL.—A thorough and comprehensive system of inspections is a primary requisite for the satisfactory operation of motor vehicles. Inspection has for its purpose the detection of deficiencies in mechanical condition, appearance, servicing and operation of motor vehicles, and the recommendation of corrective measures to prevent recurrence of such deficiencies. While the appearance of the vehicle as a whole is of some concern, the important inspection is that which covers the adjustments and mechanical condition of operating units, and that which investigates the lubrication of a vehicle with a view to maintaining standards of reliability and performance originally built into the vehicle. Such inspections are classified as command, maintenance, and technical inspections.

a. *Command inspections*.—It is the duty of all commanders to make regular and frequent inspections of their motor ve-

hicles and of the operating and maintenance activities of their commands.

b. Maintenance inspections.—Maintenance inspections are a part of scheduled maintenance operations and normally should be performed by personnel of the operating organization during and upon completion of these operations.

(1) *Daily inspections.*—Daily maintenance inspections normally are made by the chief of section under the supervision of company, battery, or similar unit officers. They consist in checking and supervising the work of the vehicle operator in his performance of daily maintenance operations.

(2) *Weekly inspections.*—Weekly maintenance inspections normally are made by the chief of section under supervision of company, battery, or similar unit officers. They consist of checking and supervising the work of the vehicle operator in his performance of weekly maintenance operations. In addition, the chief of section should examine the less accessible places, looking for rust spots, leaks, breaks, and excessive or deficient lubrication. The serviceability and completeness of tools and other equipment should be thoroughly checked. A guide for his weekly inspection should be drawn up and issued to him to fit the particular vehicle or vehicles he is assigned. A suggested guide is as follows:

Accident report	-----
Appearance	-----
Battery	-----
Body bolts and screws	-----
Bows	-----
Brakes	-----
Broken metal	-----
Bumper and tow hooks	-----
Canvas	-----
Chains	-----
Condition of motor	-----
Curtain fasteners	-----
Doors	-----
Driver's permit	-----
Extinguisher	-----
Fender bolts	-----
Fenders	-----

- Floor boards-----
 Glass-----
 Handle and latches-----
 Hood fasteners-----
 Horn-----
 Insulating material-----
 Keys-----
 Leaks on ground-----
 Lights-----
 Lubrication-----
 Mats-----
 Rear view mirror-----
 Running boards-----
 Running gear-----
 Seat brackets-----
 Servicing-----
 Special mountings-----
 Springs-----
 Steering-----
 Straps-----
 Tail gate-----
 Tires:
 Cuts-----
 Inflation-----
 Unusual wear-----
 Tool brackets-----
 Tools-----
 Traction devices-----
 Upholstering-----
 Wheel lugs-----
 Windshield wiper-----
 Defects to be corrected:

(3) *Lubrication inspections.*—All lubrication operations performed by the driver normally are inspected by the chief of section. The motor sergeant inspects all lubrication, in-

cluding that performed by the driver, if any, and that performed by unit maintenance personnel.

(4) *Monthly (1,000-mile) inspections.*—The monthly (1,000-mile) maintenance inspection is a check on company, battery, or similar unit maintenance. It normally is made by the motor officer of that unit but may be made by the regimental, battalion, or similar unit motor officer. Before reporting a vehicle to the motor officer for maintenance inspection, the motor sergeant assures himself that the work of his mechanics has been properly performed and that no items have been overlooked. The motor officer spot checks such items as he believes necessary, including those that are inaccessible or frequently neglected. He should make a short road test of the vehicle.

(5) *Six-months (6,000-mile) inspections.*—The six-months (6,000-mile) maintenance inspection is a check on the maintenance work performed by the regiment, battalion, or similar unit. It will be made by the unit motor officer, assisted by qualified enlisted personnel, upon completion of the six-months (6,000-mile) maintenance operation in a manner similar to that described for the monthly (1,000-mile) maintenance inspection.

c. Technical inspections.—Technical inspections are made by fully qualified technical personnel of the supply services to determine the vehicle condition. These inspections are covered in AR 850-15, in Circular 1-10, OQMG, and TM 10-545.

SECTION VII

RECORDS AND REPORTS

■ 229. **GENERAL.**—In maintaining a fleet of motor vehicles certain reports and records are indispensable. They must be simple and complete, and must be prepared by qualified personnel. The regimental or similar organization motor officer should periodically assemble all personnel of the regiment who prepare these records and reports, and explain and demonstrate the simplest yet correct manner of keeping them. Posting of all reports daily or at relatively short intervals should be required, and a careful check should be maintained by the commanding officers of all units operating and maintaining motor transportation. Records often clearly indicate

items that require attention. Usually high fuel consumption or low oil mileage indicates poor performance or unauthorized disposition of fuel or oil. Excessive repairs might indicate poor, careless or indifferent driving. The records as a whole keep the organization commander informed of the general condition of the vehicles and assist him in making timely request for supplies, repairs and replacement.

■ 230. REPORTS AND RECORDS REQUIRED BY REGULATIONS.—*a. Standard Form No. 26 (Driver's Report—Accident, Motor Transportation)*.—This form must be carried on every military motor vehicle. Its use is mandatory whenever a military driver is involved in an accident, no matter how trivial it may be.

b. Standard Form No. 27 (Investigating Officer's Report—Accident, Motor Transportation).—The officer designated to investigate an accident submits his report on a motor vehicle accident on this form.

c. W. D., Q. M. C. Form No. 228 (U. S. Army Motor Vehicle Operator's Permit).—This permit must be in the possession of a vehicle operator at all times when he is operating a motor vehicle. It should not be issued without a thorough test as to driver's ability.

d. W. D., Q. M. C. Form No. 260 (Technical Inspection Report of Motor Vehicles).—This form is used in recording the technical inspections required by existing regulations and for such other inspections as may seem desirable.

e. W. D., Q. M. C. Form No. 237 (Driver's Trip Ticket and Performance Record).—No vehicle will be dispatched unless a trip ticket accompanies the vehicle. Upon completion of the trip, drivers should be required to complete the form in full detail. These forms provide information required in the vehicle service record books. These forms need not be issued to groups of vehicles on a march or a convoy.

f. W. D., Q. M. C. Form No. 248 (Motor Vehicle Service Record Book).—This record is kept for every quartermaster motor vehicle in operation. It constitutes the service record of the vehicle and must be transferred with it. Instructions relative to the posting of this record are contained in the book itself. This is a most important record, and must be accurately and promptly posted.

*g. W. D., O. O. Form No. 5956 (Ordnance Motor Book).—*This record is kept for every ordnance vehicle in operation. It constitutes the service record of the vehicle and must be transferred with it. Instructions relative to the posting of this record are contained in the book itself. This is a most important record, and must be accurately and promptly posted.

h. Other forms.—Other prescribed forms are:

(1) W. D., Q. M. C. Form No. 220 (Data for Registration—Motor Vehicle).

(2) W. D., Q. M. C. Form No. 221 (Motor Vehicle Transfer Form).

(3) W. D., Q. M. C. Form No. 252 (Annual Physical Inventory Report of Motor Vehicles).

(4) W. D., Q. M. C. Form No. 253 (Annual Report of Motor Vehicle Changes of Accountability).

(5) W. D., Q. M. C. Form No. 231 (Gasoline and Lubricant Issue Slip), W. D., Q. M. C. Form No. 437 (Delivery Order and Receipt), W. D., Q. M. C. Form No. 438 (Daily Abstract of Issues of Fuel, Forage, Gasoline and Oils, and Operating Supplies), W. D., Q. M. C. Form No. 440 (Monthly Abstract of Issues of Fuel, Forage, Gasoline and Oils, and Operating Supplies), and W. D., Q. M. C. Form No. 425 (Abstract of Property not otherwise accounted for). W. D., Q. M. C. Form No. 231 should be used when required as a requisition on the gasoline filling station to supply fuel and lubricants required. Under Change No. 5, Circular 1-5, O. Q. M. G., 1940, after issues are made they are receipted for on Form No. 437. These Forms Nos. 437 are posted daily to Form No. 438 as evidenced by the original Form No. 437. The totals of the daily abstract on Form No. 438 in turn are posted on Form No. 440. At the end of the month Form No. 440 will be totaled, the issues will be certified by the quartermaster and the quantities dropped from Form No. 425.

(6) W. D., Q. M. C. Form No. 254 (Daily Dispatching Record of Motor Vehicles).

(7) These forms and others necessary or beneficial in keeping the above records or making the above reports should be obtained from the supply services when available, otherwise such forms or charts must be prepared locally to meet requirements. Forms used for controlling and recording motor maintenance records are listed in the current "Regulations

governing industrial activities at motor repair shops of the Quartermaster Corps," and may be adapted to requirements of organizational maintenance activities.

i. Special forms.—These must be developed and improved locally, as necessary.

(1) *Automotive operations sheets.*—A major part of the data for the W. D., Q. M. C. Form No. 248 (Motor Vehicle Service Record Book) is abstracted from the driver's trip tickets. When the entries on this record book are made monthly, a bulky stack of trip tickets accumulates before the entries can be made in the record book. To obviate this condition and to consolidate all operating, inspection, and maintenance data, the operations sheet shown in appendix VIII may be utilized. One of these is required for each vehicle, and is an invaluable aid to the maintenance personnel.

(2) *Preventive maintenance operations guides.*—Models of forms that can be adapted to meet any requirement will be found in TM 10-540 and 10-545.

(3) *Motor vehicle morning report.*—This form as shown in appendix VII can be modified and adapted to local needs so as to give the motor transport officer concerned a day-by-day report on the status of all motor vehicles of the organization, pool, or similar establishment.

CHAPTER 8

LOADING FOR MOVEMENT BY RAIL OR WATER

SECTION I. Movements by rail.....	Paragraphs 231-232
II. Movements by water.....	233-237

SECTION I

MOVEMENTS BY RAIL

■ 231. REFERENCES.—Information concerning rail movements may be found in AR 30-930, 30-935, 30-940, 30-945 and 30-955, and in FM 101-10. In the absence of such regulations the local rail transport officer should be consulted.

■ 232. GENERAL PROCEDURE.—a. When individual motor vehicles are shipped or when an organization does not accompany its transportation, vehicles are turned over to the local quartermaster for shipment. In this case the quartermaster is normally responsible for furnishing the necessary personnel and material for loading and blocking equipment.

b. In organized rail movements of troops and their transportation, organizations are grouped and their vehicles are loaded and blocked by their own personnel on suitable railroad cars. Vehicles are usually shipped on flat cars (36 to 60 feet in length), gondolas (36 to 60 feet in length), or special box cars (usually 50 feet in length) designed for the handling of motor vehicles. Automobile or flat cars with wooden floors are most desirable because of the ease of loading them and blocking the loaded vehicles. (See FM 101-10.)

c. For tactical organizations moved by rail, the necessary administrative orders detailing procedure and methods of loading are issued by the commander of the tactical organization through his staff. Normally a quartermaster officer is charged with the responsibility of making the necessary arrangements with the railroad company for the type and number of cars required and point and time of delivery. Sufficient notice should be given this officer to allow him ample time to procure the equipment. If the tactical organization is not near any post, camp, or station or in contact

with a representative of the Quartermaster Corps, the supply officer of the organization usually becomes responsible for making the necessary arrangements with the railroad company. The inspection and preparation of railroad equipment before and after loading, such as removing brake handwheels, is accomplished by railroad employees and an inspection is made by the quartermaster. Whenever it is possible to do so, permanent teams should be used for loading and blocking. Because of their increasing familiarity with their particular jobs, these teams will be more efficient and will accomplish more work than would different teams for each organization. In the long run this procedure will result in saving time and labor. For details as to preparation of motor vehicles for loading, equipment and material needed, and railroad specifications, see FM 101-10.

SECTION II

MOVEMENTS BY WATER

■ 233. GENERAL PROCEDURE.—Preparation of vehicles for water shipment is accomplished by military personnel. Loading and securing of vehicles is accomplished by the ship's personnel under the direction of the transport's officer and with the use of the transport's loading rigging. After loading, movement of vehicles into position on board should be done by the regular military drivers under the vehicles' own power, when practicable. Because of the dovetailing of the duties of ship's crew and military personnel, close coordination is essential between the ship's officer and the commissioned officer in charge of loading.

■ 234. PREPARATION FOR SHIPMENT BY TRANSPORT.—Preparation of a vehicle for water shipment is, with obvious modification, the same as that laid down for rail shipment. When the vehicle, after being loaded is to be moved into position on board under its own power, gasoline and water are not drained and the battery is not disconnected until the vehicle is in its final position. Preparation of tires, tops, curtains, cushions, and loose property is the same as for rail shipment. Because of a greater tendency for parts to rust during water shipment, special attention must be given to rust prevention. All exposed bright metal parts and exposed

working parts should be greased, and engines should be cranked several turns about every 3 days, oftener if necessary. Under conditions especially likely to cause rust, engines should also be slushed internally with heavy oil inserted through spark plug openings. As in the case of rail shipments, an inspection with the aid of a check list should be conducted to insure that the vehicle is properly prepared for shipment (app. VI).

■ 235. **FACILITIES FOR LOADING.**—Loading vehicles on board is accomplished by ship's personnel with the use of the ship's loading rigging. This usually consists of a boom rigged with a block and a winch or similar rigging. Vehicles are raised from the dock and lowered into the hold by means of a sling.

■ 236. **SECURING VEHICLES ON BOARD.**—Vehicles placed below decks, where there are usually wooden floors, are blocked and secured as described for rail shipment on flat cars. On deck or on other metal floors, vehicles must be lashed in place with stout rope. In either case lengthwise, sidewise, and bouncing motion of the vehicle should be eliminated. Miscellaneous loose equipment is to be boxed and secured to avoid shifting which would damage vehicles and avoid loss incident to pilferage. After the vehicles are completely secured, the hatches are sealed. Frequent inspections should be conducted especially during rough weather, to insure that the blocking and lashing is holding, and that the vehicles are riding without damage.

■ 237. **UNLOADING.**—Unloading is conducted again by the ship's personnel and with the same ship's equipment, as was used for loading. After the vehicles have been serviced, an inspection with the aid of the original loading check list should be made to insure that the vehicle is properly prepared to resume operation.

APPENDIX I

LIST OF REFERENCES

■ 1. ARMY REGULATIONS.

AR 30-955, Transportation of Supplies.

AR 40-75, Ambulances—General Provisions.

AR 730-10, Fuel and Lubricants for Motor Vehicles and Equipment Used for Training Purposes.

AR 850-5, Marking of Clothing, Equipment, Vehicles, and Property.

AR 850-10, Registration and Inventory of Motor Vehicles.

AR 850-15, Military Motor Vehicles.

AR 850-18, Storage of Motor Vehicle Equipment.

■ 2. OTHER PUBLICATIONS.

Field Service Regulations, FM 100-5.

Staff Officers' Field Manuals, FM 101-5 and 101-10.

Field Manuals for the arms, FM 5-10, 5-25, 5-30, and 5-35.

Basic Field Manuals, FM 21-40 and 29-5.

Technical Manuals, TM 10-540 and 10-545.

Circular 1-10, OQMG, Motor Transportation.

Quartermaster motor transport technical service bulletins.

APPENDIX II

SCHEDULE OF INSTRUCTION—DRIVER TRAINING

■ 1. The following schedule of instruction which requires approximately 85 hours is designed primarily as a guide for the training of drivers who are to operate trucks with towed loads, but with obvious modifications it will be satisfactory for the training of drivers for any military motor vehicle. The training includes conferences, demonstrations, and practical periods and is terminated with a qualification examination. The continuity of instruction may be changed to meet local conditions if related conferences and practical periods are coordinated.

1ST PERIOD (2 hours).

a. Conference.

- (1) Responsibility of drivers.
- (2) Personnel and general duties.
 - (a) Unit commander.
 - (b) Motor officer.
 - (c) Motor sergeant.
 - (d) Mechanics.
 - (e) Chiefs of section or truckmasters.
 - (f) Drivers.
- (3) Fire prevention and fire fighting.
 - (a) Precautions against fire. (AR 850-15 and local orders.)
 - (b) Proper methods of fighting fires.
 1. Gasoline and oil fires—Fire extinguishers, blankets, sand, and chemicals.
 2. Other fires.
 - (c) Location of fire-fighting equipment.
 1. In and around motor park.
 2. On the motor vehicle.
 - (d) Method of reporting fire—Location of telephones, how and whom to call.
- (4) Accident prevention.
 - (a) Precautions against accidents.
 - (b) Carbon monoxide poisoning.
 - (c) Whom to call to get assistance.
- (5) Care, condition, and use of vehicle tools and equipment.

b. Questions on material covered during the period.

2D PERIOD (light vehicle, 3 hours).

a. *Conference and demonstration.*

- (1) The command truck, pick-up truck, or any appropriate vehicle.
 - (a) Use.
 - (b) General nomenclature.
 - (c) Vehicle equipment.
 - (d) Characteristics.
- (2) Inspection prior to starting engine.
- (3) Proper method of starting engine, to include cold-weather starting.
- (4) Proper warm-up of engine.
- (5) Inspection after starting engine.
- (6) Driver's position.
- (7) Positions of the gear shift lever.
- (8) Proper use of the clutch, accelerator, gear shift lever, brakes, and other controls to start, change gears, and stop the vehicle.
- (9) Driver's arm signals.
- (10) Signals for control of the unit.

b. *Practical.*—(Vehicles may be blocked with all wheels off the ground. A qualified instructor is assigned to each vehicle.)

- (1) Inspection prior to starting engine, by the numbers.
- (2) Students mount, assume correct position, and familiarize themselves with controls. (Engine *not* running.)
- (3) Start and warm up engines.
- (4) Inspection after starting engine, by the numbers.
- (5) Drivers shift transmission into each of the several ratios at will.
- (6) Drivers shift into designated speeds and change direction on signal of instructor. Students give proper arm signals. Repeat until drivers are reasonably proficient.
- (7) Stop engines.

c. *Conference and demonstration.*

- (1) Inspection during operation.
- (2) Inspection at the halt.
- (3) Driver's trip ticket.

d. Questions on material covered during the period.

3D PERIOD (light vehicle, 3 hours).

(Command, pick-up trucks or any appropriate vehicle on a large, unobstructed field prior to the conference or driven to the field by the assistant instructors.)

a. *Conference and demonstration.*

- (1) Inspection prior to leaving park.
- (2) Proper procedure to put vehicle in motion.
- (3) Proper method of shifting gears and appropriate gear to use.
- (4) Proper method for stopping vehicle.
- (5) Proper method for backing vehicle.
- (6) Duties of assistant driver.
- (7) Rules of the road.
- (8) Arm signals for various maneuvers limbered.
 - (a) Explain movements.
 - (b) Distance, interval, guides.
- (9) Issue trip ticket.

b. *Practical.*

- (1) Inspection prior to starting engine, by the numbers.
- (2) Inspection after starting engine, by the numbers.
- (3) Inspection prior to leaving park, by the numbers.
- (4) Preliminary driving. Students, accompanied by qualified instructors, drive at will to familiarize themselves with the manipulation and performance of their vehicles.
- (5) Form vehicles in column and maneuver by arm signals.
- (6) Form line and halt.
- (7) Inspection at the halt, by the numbers.

c. *Conference.*—Organization and formation of the motor park.

d. *Practical.*

- (1) Caretaking.
- (2) Inspection after caretaking.
- (3) Completion of trip ticket.

e. Question drivers.

NOTE.—In all succeeding periods where operation is involved, include the following, if applicable:

Issue of trip ticket.

Inspection prior to starting engine.

Inspection after starting engine.

Inspection prior to leaving park.
 Inspection during operation.
 Inspection at halt.
 Forming park.
 Caretaking.
 Inspection after caretaking.
 Completion of trip ticket.

4TH PERIOD (light vehicle, 3 hours).

(Vehicles in open field or on unused road. Stakes should mark the places for shifting and stopping.)

a. Conference.—Review of controls.

b. Practical.

- (1) Driving and shifting.
- (2) Simple, easy turns.
- (3) Starting and stopping.

5TH PERIOD (light vehicle, 3 hours).

(Vehicles on a field marked to simulate a street corner.)

a. Conference and demonstration.

- (1) Arm signals.
- (2) Right turn.
- (3) Left turn.
- (4) Right-of-way at intersections.
- (5) U-turns.
- (6) Intersection markings and signs.
- (7) Turns on multiple-lane highways.
- (8) Review safety precautions.

b. Practical.

- (1) Right turn from stop.
- (2) Left turn from stop.
- (3) Right turn moving.
- (4) Left turn moving.
- (5) Right turn with opposing traffic.
- (6) Left turn with opposing traffic.

6TH PERIOD (light vehicle, 3 hours).

a. Conference and demonstration.

- (1) Nomenclature and functioning of vehicle units and assemblies with particular attention to lubrication. (To be carried on through the remainder of the course or until drivers are qualified in this subject.)
- (2) Weekly inspection.
- (3) Drivers' maintenance.

MOTOR TRANSPORT

b. Practical.

- (1) Inspections.
- (2) Proper method of doubling (passing).
- (3) Proper method of parking.
- (4) Stopping distances.
- (5) Drivers' maintenance; cleaning, lubricating, inspecting, servicing, tightening, and emergency repairing.

7TH PERIOD (truck, 3 hours).

(Trucks in an open field or on unused road. Stakes placed to indicate places for shifting and stopping and a marked intersection.)

a. Conference.

- (1) Use of controls.
- (2) Shifting to higher gears.
- (3) Stopping.

b. Practical.

- (1) Driving and shifting.
- (2) Simple, easy turns.
- (3) Starting and stopping.
- (4) Right turns from stop.
- (5) Left turns from stop.
- (6) Right turns moving.
- (7) Left turns moving.
- (8) Right and left turns with opposing traffic.
- (9) Tight circle turns.

8TH PERIOD (truck, 3 hours).

a. Conference and demonstration.

- (1) Vehicle characteristics.
- (2) Double clutching.
- (3) Gear range (auxiliary transmission-transfer case).
 - (a) Purpose.
 - (b) Use.
 - (c) Location and operation of shift lever.
- (4) Four-speed transmission—Positions of gear shift lever.

b. Practical.—Driving.

9TH PERIOD (truck, 3 hours).

- (1) Cross-country driving.
- (2) Driving through water.
- (3) Changing tires and repairing tubes.

- (4) Application of traction devices.
- (5) Use of winch.
- (6) Accident report.

b. Practical.—Cross-country driving, fairly difficult.

10TH PERIOD (truck with towed load, 3 hours).

a. Conference and demonstration.

- (1) Precautions for towed loads.
- (2) Loads, loading, and lashing.
- (3) Coupling.
- (4) March formations, signals, and distances.
- (5) Rules of the road.
- (6) Reading of road maps.

b. Practical.—Maneuvers, followed by a short road march on good roads.

NOTE.—Drivers' inspections must include towed load.

11TH PERIOD (truck with towed load, 3 hours).

a. Conference and demonstration.—Special maneuvers for arm or service.

b. Practical.—Maneuvers as covered by appropriate regulations.

12TH PERIOD (truck with towed load, 3 hours).

a. Conference.

- (1) Traffic regulations.
- (2) Road marches.
 - (a) Distances.
 - (b) Speeds.
 - (c) Route markers.
 - (d) March regulations.
- (3) Passage through cities and congested areas.

b. Practical.—Road march on good roads.

13TH PERIOD (truck with towed load, 3 hours).

a. Conference and demonstration.

- (1) Difficult draft.
- (2) Field expedients.

b. Practical.

- (1) Cross-country driving, difficult.
- (2) Occupation of position.
- (3) Disposition of vehicles during firing.
- (4) Camouflage and dispersion of vehicles.

14TH PERIOD (truck with towed load, 3 hours).

a. Conference.

- (1) Driving in traffic.
- (2) Review rules of the road.
- (3) Review traffic regulations.
- (4) Map reading.

b. Practical.—Road march in traffic.

15TH PERIOD (truck and towed load, 3 hours).

a. Conference.—Roadside repairs.

- (1) Normal.
- (2) Emergency.
- (3) Action upon return to park.

b. Practical.—Road march in traffic.

16TH PERIOD (truck with towed load, 3 hours).

a. Conference.—Night marching.

- (1) With lights.
- (2) Without lights.

b. Practical.—Night march, with lights, fairly good roads.

17TH PERIOD (truck with towed load, 3 hours).

Practical.—Night march, without lights, same road as 16th period.

18TH PERIOD (truck with towed load, 3 hours).

Practical.—Night march, cross-country, with lights.

19TH PERIOD (truck with towed load, 3 hours).

Practical.—Night march, cross-country, without lights.

20TH PERIOD (truck with towed load, 8 hours).

Practical.—March over varied terrain.

21ST PERIOD (truck with towed load, 6 hours).

*Practical.**a. Night march over varied terrain.**b. Disposition of vehicles.*

22D PERIOD (3 hours).

a. Conference and demonstration.—Preparation of vehicle for 1,000-mile scheduled maintenance.*b. Practical.*—Preparation of vehicle for 1,000-mile scheduled maintenance.

23D PERIOD (4 hours).

Demonstration and practical.—1,000-mile scheduled maintenance.

24TH PERIOD (2 hours).

Demonstration and practical.—Complete lubrication of vehicle.

25TH PERIOD (2 hours).

a. Conference and demonstration.—Formal inspection.

b. Practical.—Formal inspection.

26TH PERIOD (2 hours).

Examination, theoretical, for driver's permit.

27TH PERIOD (2 hours).

Examination, practical, for driver's permit.

■ 2. If personnel are selected carefully, the instruction in the training schedule will turn out drivers who are capable of good performance under all reasonable operating conditions. Additional instruction in maneuvers, inspections, and ceremonies, as covered by appropriate regulations and manuals, may be necessary for the various arms and services. If more or less time is available for instruction, the schedule should be changed generally as follows: With more time available, increase the driving time; with less time available, decrease the conference time.

APPENDIX III

ROAD TEST PROCEDURE (SHORT FORM)

■ 1. PURPOSE.—A road test is usually given for one of two reasons:

a. To determine whether a man is qualified to operate a given vehicle.

b. To determine what type of corrective training a driver needs most. A good road test also tends to raise the standards of driving instruction.

■ 2. REQUIREMENTS OF GOOD ROAD TEST.—a. The test should be as long as time will permit in order that a fair sample of driving situations may be included; 20 minutes should be considered as an absolute minimum.

b. The test should include difficult maneuvers which really test a man's ability. Most any person can drive successfully "around the block."

c. A standard procedure and test route should be used so that the test will be the same for all men examined.

d. The examiner should check definite items concerning the driver's performance in order to reduce subjective judgment, and to point out driving faults which may be corrected by proper training.

■ 3. ROAD TEST CHECK LIST.—a. As a guide for giving the test, a check list should be used. This should be brief so as not to confuse the examiner and yet it should be long enough to include the more important elements of driving. Following is a suggested "Road test check list."

Name _____ Serial Number _____
 Organization _____ Date _____

ROAD TEST CHECK LIST

Point score _____ Final rating: 1 2 3 4 5

Weight .	Starting vehicle (O. K. _____)
1 _____	1. Starts motor with gears engaged
1 _____	2. Starts motor with clutch engaged
1 _____	3. Fails to release handbrake
1 _____	4. Kills motor in starting
4 _____	5. Jerks in starting

BASIC FIELD MANUAL

<i>Weight</i>	<i>Stopping on level (O. K.-----)</i>
1-----	6. Motor not used for braking
1-----	7. Jerks in stopping
	<i>Use of controls (O. K.-----)</i>
4-----	8. Does not double clutch
3-----	9. Strains motor
1-----	10. Rides clutch
1-----	11. Clashes gears
1-----	12. Uses brake excessively
1-----	13. Tries over 1 shifting 4th to 3d
1-----	14. Tries over 1 engaging f. w. d.
1-----	15. Tries over 1 engaging low range
	<i>Hand signals (O. K.-----)</i>
1-----	16. Not given for STOP
1-----	17. Not given for RIGHT TURN
2-----	18. Not given for LEFT TURN
	<i>Stop signs (O. K.-----)</i>
1-----	19. Goes through 0 to 5 mph
2-----	20. Goes through over 5 mph
	<i>Driving on hills (O. K.-----)</i>
4-----	21. Goes up in wrong gear
2-----	22. Stops to shift while going up
3-----	23. Stalls motor while starting on hill
3-----	24. Jerks in starting on hill
2-----	25. Rolls back over 1 foot in starting
1-----	26. Coasts driving down hill
3-----	27. Coasts backing down hill
	<i>Driving through mud (O. K.-----)</i>
1-----	28. Engages f. w. d. late
2-----	29. Falls to use f. w. d.
2-----	30. Stops while in mud
	<i>Steering (O. K.-----)</i>
1-----	31. Fails to keep to right
1-----	32. Drives off road
1-----	33. Cuts corners
1-----	34. Swings wide on turns
	<i>Parallel parking (O. K.-----)</i>
2-----	35. Backings over 1
1-----	36. Markers or curb hit
1-----	37. Feet left wheels outside
	<i>Backing to platform (O. K.-----)</i>
1-----	38. Backings over 1
1-----	39. Feet over 1 from platform
1-----	40. Markers or platform hit
	<i>Miscellaneous</i>
1-----	41. Speed excessive for conditions
20-----	42. Accident
10-----	43. Near accident
5-----	44. General rating: 1 2 3 4 5
Years of driving experience -----	Miles last year -----
Driving of 1½-ton } Civilian (yrs) -----	
truck or heavier } Army (hrs) -----	
Hours of driving type of truck used for test -----	
Comments: -----	

Examined by -----	

b. The check list is based on an enumeration of errors most likely to be made by a driver of an Army vehicle. Through previous study the elements have been selected which are the best indicators of general driving ability. The items have been weighted in terms of their correlation with general driving ability. In giving the test a check mark is recorded each time an error is made or repeated.

■ **4. SUGGESTED PROCEDURE FOR GIVING ROAD TEST.**—In giving the test the driver should be put at ease as far as possible in order to determine his normal driving. The first part of the course should be straight and level to enable the driver to become familiar with the operation of the truck. For most testing a 2½-ton all-wheel-drive truck will be satisfactory. In general, drivers should be tested in the type of truck they will be expected to drive.

a. Starting vehicle.—(1) Before the driver gets into the truck to take the test, the hand brake should be set, the ignition turned off, the transmission engaged, the front wheel drive disengaged, and the transfer case placed in high range.

(2) Ask the driver to start engine and proceed down the road. Place a check mark before items 1 to 5 for any error made. Each time any of these errors are repeated use additional check marks. By the time the test is completed some items may have a large number of check marks.

b. Stopping on level.—At some place in the course ask the driver to come to a stop. Check item 6 if the clutch is depressed before the brake so that the motor is not used for braking. Check item 7 if a jerk is made.

c. Use of controls.—(1) The coordination of the driver in the manipulation of brake, clutch, gear shift, etc., is to be observed throughout the test and checks made when errors occur. Check item 8 if the driver has trouble in shifting because he does not double clutch. If on a heavy pull, the driver strains the motor instead of shifting to a lower gear, check item 9. Check the other items each time an error is made. Some time during the test when the truck is in 4th gear ask the driver to shift to 3d. If the shift is made on the first try, do not check item 13. However, if the driver must try more than once, use a check mark for each try in excess of 1. If the gears are clashed, check item 11.

(2) At another part of the course ask the driver to engage front wheel drive and at still another place ask him to shift to low range. Use a check mark for each try necessary in excess of 1.

d. Hand signals.—The test route should include at least three right and three left turns. Check items 16, 17, and 18 each time a signal is not given. If signals are given but given improperly, make a note under "Comments."

e. Stop signs.—The route should include at least two stop signs. Check item 19 if a complete stop is not made.

f. Driving on hills.—If the terrain permits, part of the course should include steep hills and mudholes. If the driver must stop to shift while going up, check item 22. When part way up a hill, have the driver stop, shut off the motor, and then proceed up the hill. Check items 23, 24, and 25 for errors made in starting. Ask the driver to back part way down a hill. If the driver does not use reverse gear, check item 27.

g. Driving through mud.—If the driver fails to engage front wheel drive before getting into mud, check item 28. Check item 29 if front wheel drive is not used even though driver gets through mud. If the driver has to stop while in the mud for any reason, check item 30.

h. Steering.—Observe the steering throughout the test and check each time an error is made.

i. Parallel parking.—Mark off a space with lines for parallel parking, 8 feet wide and 10 feet longer than the truck from bumper to bumper. Use a log for a curb if one does not exist. Use 6-foot posts or stakes set in kegs filled with dirt to mark the ends and corners of the space. Do not allow over three backings. Check item 35 for each backing over 1, item 36 each time a marker or the curb is hit, and item 37 once for each foot the left wheels are outside the 8-foot limit line when parking is completed. Count the left wheel that is farthest out of the parking space.

j. Backing to platform.—Mark off a space 10 feet wide and extending 20 feet from a loading platform. Use posts or stanchions to mark the edges. Check item 38 for each backing required in excess of 1. Check item 40 each time a marker or the platform is touched. When the driver is parked, measure the distance from rear bumper to platform.

Place one check mark for item 39 for each foot in excess of 1. If the truck were 3 feet away, two check marks would be used.

k. Miscellaneous.—Check these items each time they occur. Circle one of the figures after item 44, giving a general estimate of the driver without regard to individual items; 1 is very good, 3 is average, and 5 is failure.

■ 5. SCORING ROAD TEST.—*a.* The “point score” is the sum of the check marks multiplied by their weightings. For example, item 9 checked twice would count 6 points. For item 44, multiply the rating by 5. A rating of 4 would thus count 20 points. The addition of all points from items 1 to 44 will give the point score. After a number of drivers have been tested a scale should be worked out so that a “final rating” can be given on the basis of the point score. A rating of 1 would include the best drivers—those with the lowest point scores.

b. Any driving faults not included in the check list should be listed under “Comments.” As an educational measure, the various driving faults should be explained to the driver at the conclusion of the test.

APPENDIX IV

WRITTEN EXAMINATION FOR DRIVER

Place a check in the column "T" if the statement is true; in column "F" if false.

T	F	
		1. Racing an engine to warm it up is advisable.
		2. The hand brake should be set when motor is started.
		3. The clutch should be disengaged when the motor is started.
		4. While driving, the right foot rests on the accelerator and the left foot on the clutch pedal.
		5. Driver inspects for leaks under motor by crawling under vehicle while engine is running.
		6. Driver is responsible for tightening all loose bolts and nuts.
		7. Driver inspects for loose and broken parts before washing vehicle.
		8. In case a person is overcome by carbon monoxide gas he should be removed from gassed building and given a stimulant.
		9. Traction devices should be placed on wheels before moving out of motor park in muddy weather.
		10. If oil pressure gage shows zero, it should be reported after reaching motor park.
		11. Driver checks panel instruments only before and after operation.
		12. Driver uses only two types of lubricants, chassis and oil.
		13. In case of emergency, driver applies pressure enough to lock all brakes.
		14. The service brake is applied by hand.
		15. Driver should disengage clutch while descending grades.
		16. All vehicles should pull to side of road when siren is heard.
		17. Left turns are made from right lane.
		18. Signal for right turn is: Arm straight out.
		19. Battery water level recommended is: Cell filled up to filler cap.
		20. Sediment bowls should be removed and cleaned daily.
		21. Driver's Accident Report should be made immediately upon returning to the motor park.
		22. Wheel-bearing grease is soluble in water.
		23. Water-pump grease is soluble in water.
		24. It is very essential in using the winch that the line be kept tight at all times.
		25. The monthly (1,000-mile) inspection is made by the driver.
		26. A cause of crankcase dilution is overchoking.
		27. It is recommended that trip tickets be turned in weekly.
		28. When mounting dual tires, the worn tires should be placed on the inside.
		29. A driver starting in column always signals by extending the left arm outward and upward when his vehicle is ready to move.

MOTOR TRANSPORT

	T	F	
			30. A driver is not personally liable when driving a Government vehicle.
			31. A driver of a military vehicle does not have to comply with local traffic regulations.
			32. Any member of the United States Army is authorized to drive a military vehicle.
			33. For economical operation, it is permissible in the Army to mix different makes of lubricants.
			34. A military driver may use gasoline to clean his engine.
			35. A military vehicle is never moved until the engine has reached the proper operation temperature.
			36. A military driver is responsible that his vehicle tools are always present, complete, and in serviceable condition.
			37. A military driver, after discovering a mechanical condition injurious to further operation of his vehicle, will continue in column unless ordered to fall out by higher authority.
			38. A military driver is responsible that the load of his vehicle does not exceed the rated capacity.
			39. A military vehicle is backed without signal when no men or vehicles are observed in the vicinity.
			40. A military driver should always know his destination and route before leaving the motor park.
			41. It is not essential that military drivers have a practical knowledge of map reading.
			42. Correct tire pressure can be satisfactorily determined by kicking the tire.
			43. If a driver is careful, it is not necessary to plug holes in the battery cell filler cap when washing top of battery with soda water.
			44. Arms crossed in front of body is the signal for cranking motors.
			45. Dual tires should be inspected at each halt and objects wedged between tires removed immediately.

APPENDIX V

REGULATIONS CONCERNING SHIPMENT OF EXPLOSIVES AND GASOLINE BY TRUCK

■ 1. Interstate Commerce Commission regulations will govern the shipment of explosives and gasoline by truck. (See par. 29½, AR 30-955, and AR 850-20.)

■ 2. The movement of gasoline or explosives in trucks is a highly dangerous task. It is, therefore, essential that all personnel be constantly reminded of the safety rules governing their movement, because the slightest carelessness may have fatal results. Officers and enlisted men charged with such movements will not only instruct their men thoroughly on safety rules but will also conduct informal inspections constantly to insure that safety measures are followed. All personnel are required to call to the attention of the person concerned any violation of these safety rules.

■ 3. The following safety rules will be observed by all personnel who are engaged in moving gasoline or explosives:

Rule 1.—To prevent fire, the following measures will be constantly enforced:

a. Smoking is forbidden within 100 feet of any truck loaded with explosives or gasoline.

b. The presence of open flames, such as those produced by striking of matches, use of cigarette lighters, torches, etc., within 100 feet of any motor vehicle loaded with explosives or gasoline is prohibited.

c. At least one fire extinguisher properly filled, securely mounted in a bracket, and ready for immediate use, will be carried on each truck.

d. All personnel will be instructed in the proper use of fire extinguishers and where practicable the instructions will be supplemented by demonstration.

e. If a truck catches fire, all trucks will be moved away from the vicinity of the fire and all traffic stopped. Every practicable effort will be made to give warning of danger to inhabitants living in the vicinity.

f. When loading or unloading trucks, care will be taken to prevent explosives being placed in the vicinity of the exhaust.

g. Ignition and lighting systems will be properly insulated and frequently inspected to insure that danger from short circuits is eliminated. Trucks carrying gasoline will trail a chain or other device which drags on the road to permit the escape of static electricity.

h. Every effort will be made to prevent leaks in gasoline tanks, fuel lines and carburetors. When a leak is discovered, the truck will be unloaded and moved to a safe distance before repairs are made.

i. Oil and grease thrown from moving parts shall not be allowed to accumulate on the truck body, engine, or other places where a fire hazard may be introduced.

j. Motor vehicles transporting explosives or gasoline will not be driven past fires of any kind burning on or near the highway until after it has been ascertained that the fire can be passed with safety.

Rule 2.—Advance reconnaissance and contact with state and local officials, as prescribed in section III, chapter 4, are essential. Routes selected should avoid heavy traffic and large cities if possible.

Rule 3.—Loitering will not be permitted in the vicinity of the convoy.

Rule 4.—When a truck breaks down, it will be moved as far to the side of the road as possible and pending the arrival of an empty truck or repair party, the truck will be left in charge of a guard.

Rule 5.—Fuzes and detonating devices will not be carried in the same truck with other explosives.

Rule 6.—The interior of the truck body will be lined in such a manner that every portion of the lining with which a container may come in contact shall be of wood or other non-sparking material.

Rule 7.—Loads will be braced and stayed to prevent shifting.

Rule 8.—Trucks loaded with explosives or gasoline will never be towed or pushed by another truck except to move a disabled truck to the side of the road.

Rule 9.—Hourly halts to inspect loads and vehicles will be made.

Rule 10.—Motor vehicles transporting explosives on public roads or highways will be marked with placards bearing the

word "Explosives" in letters at least three inches high. The placards will be prominently located on each side and on the rear of the truck.

Rule 11.—No motor vehicle transporting explosives or gasoline will be left unattended upon any public street or highway.

Rule 12.—The motor will be stopped when loading or unloading trucks hauling explosives or gasoline.

Rule 13.—Where trucks are of the open body type, a tarpaulin will be used to protect the cargo from rain or the direct rays of the sun.

Rule 14.—The entire cargo of explosives or ammunition shall be contained within the body of the truck. Truck tail board or tail gate shall be closed effectively and secured.

APPENDIX VI

INSPECTION REPORT OF VEHICLES SHIPPED BY RAIL
OR WATER

■ 1. When vehicles are shipped by rail or water, an inspection should be made before and after shipment to insure that the vehicle has been properly serviced.

■ 2. The inspection should be systematic and recorded on a check list similar to the following:

<i>a. Cooling system.</i>	<i>Check</i>
(1) Pet cocks on block opened.	-----
(2) Pet cocks on radiator opened.	-----
(3) Pet cocks clear and open (insert wire).	-----
<i>b. Fuel system.</i>	
(1) Gas tank drained.	-----
(2) Engine run until remaining gas is used up.	-----
(3) Sediment bowl drained.	-----
(4) Fuel pump and carburetor drained (if possible).	-----
<i>c. Storage battery.</i>	
(1) Positive cable disconnected and taped.	-----
(2) Positive cable tied away from battery.	-----
<i>d. Tires.</i>	
(1) Inflated to 10 pounds above normal.	-----
(2) Spare tire locked.	-----
<i>e. Miscellaneous.</i>	
(1) Ignition switch off.	-----
(2) Gear shift in low gear.	-----
(3) Parking brake set.	-----
(4) Hood closed and sealed.	-----
(5) Tops, curtains, paulins and cushions secured.	-----
(6) Windshield closed and fastened.	-----
(7) Windows closed tight.	-----
(8) Doors closed, latched and locked or lashed.	-----
(9) Keys in small cloth bag tied to steering wheel (or with truckmaster or motor sergeant).	-----

BASIC FIELD MANUAL

- (10) Vehicle tagged for destination. -----
- (11) Rust-preventive measures completed. -----
- (12) Loose parts boxed and secured. -----
- (13) Tool box locked. -----
- (14) Guard posted and familiar with duties. -----
- (15) Parts missing. -----
- (16) Damages. -----

APPENDIX VII

DAILY REPORT—STATUS OF MOTOR VEHICLES
(9:00 AM)

Post Garage,
Fort Blank, Maryland

(Organization and Station)
December 21, 1940

(Date)

Type vehicle	Condition of vehicles			Total as- signed ve- hicles	Tran- sient ve- hicles	Remarks
	Serv- iceable	Needs minor repairs	Needs major repairs			
Passenger cars	6	1	1	8	-----	
½-ton pick-ups	12	3	-----	15	-----	
½-ton command	1	-----	*1	13	1	*On I and I report.
1½-ton cargo -----	4	6	2	132	*12	*Arrived 4 PM—12/20/40
2½-ton cargo -----	16	-----	-----	16	-----	
4-ton cargo -----	10	2	-----	12	-----	
¾-ton trailers	80	-----	*2	82	-----	*At Fort Meade LM shops.
4-ton wreckers -----	4	-----	-----	4	*1	*Arrived 1 PM—12/20/40
Field ambulances	3	-----	-----	3	-----	

*Indicates note made in column "Remarks."

NOTES.—One of the 1½-ton cargo trucks has been in local repair shops since Dec. 11, 1940.

J. T. SMITH,
(Truckmaster or motor sergeant).

APPENDIX VIII

AUTOMOTIVE OPERATIONS AND MAINTENANCE SHEET

Make..... Body..... U. S. A. Reg. No.....
 Organization..... Org. No. Speedometer reading 1st of month.....

Month of	Brk. Fwd.		1	2	3	4	5	6	7	8	9	10	11	12	13	14	15	16	17	18	19	20	21	22	23	24	25	26	27	28	29	30	31	TO- TAL
* Daily mileage.....																																		
* Gasoline, gallons.....																																		
* Engine oil, quarts.....																																		
* Crankcase drained (mileage).....																																		
* Tires and tubes, cost.....																																		
* Weekly maintenance operations.....																																		
* Lubrication operations and inspection.....																																		
Units, parts, materials, supplies, and temporary labor charges, cost.....																																		
Monthly (1,000-mile) maintenance operations and inspection.....																																		
Six-month (6,000-mile) maintenance operations and inspection.....																																		

*Not required for W. D., Q. M. C. Form No. 248 (Motor Vehicle Service Record).

APPENDIX IX

STANDARD FORM—DRIVER'S APTITUDE TEST

■ 1. Driver's aptitude tests will be conducted before any actual instruction in the driving of vehicles is given. Individuals rated below the minimum requirements in any phase of the test will be rechecked and if still below minimum will not be trained as drivers. Measures will be taken to have such individuals transferred to other duties. If an unsatisfactory rating is obtained, the following entry should be made in the soldier's service record: "Does not possess necessary aptitude for motor vehicle operator."

■ 2. The following tests are suggested and will be conducted under the direct supervision of a commissioned officer:

a. Test No. 1—Clearness of vision.—(1) *Equipment.*—Two forms of a Snellen chart hung on a wall at eye level and illuminated by two 25 watt lamps in reflectors placed on each side and 24 inches in front of the charts. Lights must be adjusted to prevent glare on the charts or in the eyes of the person tested.

(2) *Procedure.*—Each eye is tested separately, using separate charts, the examiner holding a card over the unused eye. The score is the smallest line read with not over one error. Individual must not see charts or observe others being tested before he is tested.

(3) *Satisfactory score.*—20/30 in each eye (Vision may be corrected by the use of glasses, except for tank drivers).

b. Test No. 2—Color blindness.—(1) *Equipment.*—Red, yellow, green, blue and orange worsted tufts. Alternate equipment: Red, green and amber lights, at least two of each.

(2) *Procedure.*—Individual picks out all red and green tufts or red and green lights.

(3) *Satisfactory rating.*—Correct identification of all red and green tufts or lights.

c. Test No. 3—Field of vision.—(1) *Equipment.*—(See fig. 33.) Mark off $\frac{1}{4}$ -inch plywood as shown with nail driven at 0 point. Two 8-inch pointers with dime sized white disks at one end.

BASIC FIELD MANUAL

(2) *Procedure.*—Have individual hold board level one inch below eye level and directly under a ceiling electric light. Stand directly in front of individual and make certain his eyes are focused on 0 point during the test. Hold pointer vertical and with white disk extending one inch above surface of board. Move from extreme back position slowly forward until seen by individual out of the corner of his eye. Keep hand and arm below board and out of sight of person tested so that he does not know from which side to expect pointer. Repeat test until two trials check within 5° for each side.

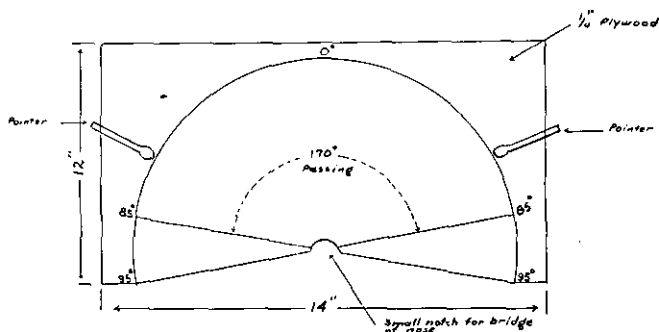

FIGURE 33.—Equipment for field of vision test.

(3) *Satisfactory rating.*—Average of 85° on each side.

d. *Test No. 4—Glare blindness.*—(1) *Equipment.*—200 watt lamp in 10-inch reflector; 7 watt night light lamp with shield; 18-inch cubical box which will rotate about a vertical axis. Box to be white with following signs painted on the four sides in black letters 6 inches high: SLOW, STOP, HILL, and TURN.

(2) *Procedure.*—Test to be given in a completely darkened room. Individual to remain in artificially lighted room at least 15 minutes and in dark room 15 minutes before testing. With individual seated, place sign exactly 30 feet straight ahead and 200 watt lamp 3 feet to left of sign so that light shines directly into face of person tested. Place 7 watt night light 3 feet to left of person tested so it will shine toward sign but shielded so it cannot glare into face of person tested. 200 watt lamp is turned on for 10 seconds while examiner

watches person tested to make sure his eyes are fixed on the glaring light. Sign is changed and 200 watt light turned off. Time for person to read sign illuminated only by the night light is recorded in seconds. Three trials are given and the average computed.

(3) *Satisfactory rating.*—A recovery time not more than twice as long as the average of the men tested with a given set-up.

e. *Test No. 5—Depth perception.*—(1) *Equipment* (see fig. 34).—Suspend 40 watt lamp with reflector 2 feet above open end of case so that rods are uniformly illuminated and with no glare toward person tested.

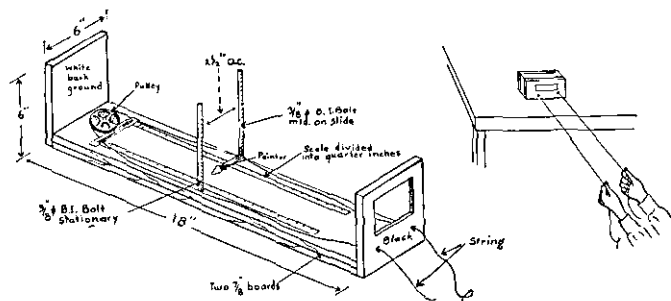

FIGURE 34.—Equipment for depth perception test.

(2) *Procedure.*—With individual seated, place test at eye level and with fixed rod exactly 20 feet away. Rods are lined up by individual pulling right or left string. Person tested must not be able to see either bottom or top of rods. Give two practice trials then record average of 6 additional trials.

(3) *Satisfactory rating.*—Average error of less than 1 inch in alinement.

f. *Test No. 6—Reaction.*—(1) *Equipment* (see fig. 35).—Make certain test is level, board fits loosely in groove and falls without friction. A curtain or hood is placed between the top of the test and the person tested so he cannot anticipate the fall of the board by noting when the string is pulled.

(2) *Procedure.*—Individual holds pointer 4 inches from board. As soon as he sees board start to fall he stops it by a thrust of the pointer. Twenty trials are taken and the number of times the board is caught is recorded.

(3) *Satisfactory rating.*—Ability to catch the board at least 10 times out of 20.

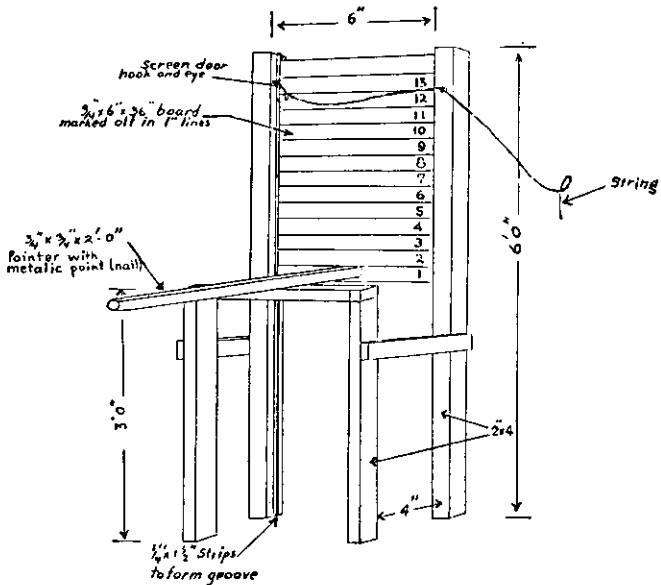

FIGURE 35.—Equipment for reaction test.

g. Test No. 7—Stability.—(1) *Equipment.*—(See fig. 36.)

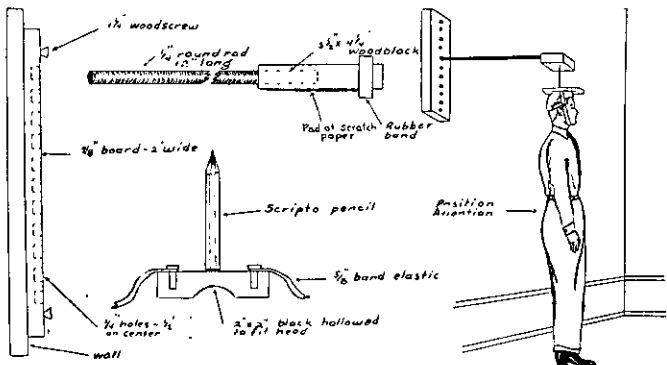

FIGURE 36.—Equipment for stability test.

MOTOR TRANSPORT

(2) *Procedure.*—The block of wood is fastened to the individual's head by means of the rubber bands and the pencil is inserted in the block. The arm to which is fastened the pad of paper is adjusted to the proper height so as just to touch the pencil. The person is directed to stand erect as quietly as possible for one minute. The variations of sway back and forth, as marked on the pad, are measured in inches and recorded.

(3) *Satisfactory rating.*—Not over 1¼ inches.

h. Suggested form for recording.

RECORD OF DRIVER'S APTITUDE TEST

Name	Clear-ness of vision	Color blind-ness	Field of vision	Glare blind-ness	Depth percep-tion	Re-action	Sta-bility	Final rating
Private A.	20/20	S	180	S	S	<i>Inches</i> 8	<i>Inches</i> 1	S
Private B.	20/20	S	180	S	S	10	¾	S
Private C.	20/20	S	165	U	U	12	1¼	U
Private D.	20/60		-----	-----	-----	-----	-----	-----

INDEX

	Paragraph	Page
A-Frame.....	183	163
Abandoning vehicles.....	221	209
Accidents:		
Conflicts, control.....	85	77
March column.....	70	68
Prevention.....	12	7
Advance—		
Guard.....	168	146
Reconnaissance.....	167	144
Air attack.....	148, 157	131, 139
Anchor, tackle.....	185	165
Antiaircraft defense:		
Active.....	147	131
Attack on column.....	148	131
Coordination.....	144	128
Passive.....	146	130
Warning service.....	145	129
Antimechanized defense:		
Barriers.....	150	132
Definition.....	149	132
Obstacles.....	150	132
Procedure on making contact.....	153	138
Security.....	152	137
Weapons.....	151	136
Aptitude test.....	App. IX	249
Army Regulations.....	App. I	226
Ascending steep slopes.....	189	167
Assistant drivers.....	60	53
Backing, practice.....	44	30
Barriers, antimechanized.....	150	132
Battery, storage, care.....	27	19
Blackouts.....	140	127
Block and tackle.....	181	163
Bog.....	192	172
Brakes.....	43	29
Bridges.....	94, 200	83, 176
Camouflage.....	138	125
Capacity:		
Hauling, column.....	124	110
Traffic.....	84	177
Troop, vehicles.....	125	110
Care:		
Storage battery.....	27	19
Tires.....	26	18
Tools.....	25	18
Chains.....	16, 175	11, 167
Chemicals, defense against:		
Decontamination.....	158	141
Intelligence.....	155	139
Protection.....	157	139
Reconnaissance.....	156	139
Reference.....	154	138

INDEX

	Paragraph	Page
Civilian authorities, cooperation.....	132	121
Cleaning.....	24	17
Clutch.....	41	27
Cold weather march.....	71	70
Columns:		
Close.....	57	46
Infiltration.....	56	43
Logistical data. (See Logistical data.)		
Movement, mechanics.....	55	41
Open.....	58	48
Passage.....	109	91
Shuttling.....	59	52
Command, motor march.....	52	39
Communication:		
Control.....	139	126
Intracolumn.....	60	53
Congested areas.....	95	64
Control:		
March column.....	60	53
Traffic:		
Personnel.....	107	90
Systems.....	106	89
Controls:		
Aids.....	37	24
Important.....	36	24
Manipulation.....	40	26
Conversion—time, distance, and speed.....	128	114
Curves.....	201	176
Deadman.....	184	164
Decontamination.....	158	141
Defense:		
Antiaircraft.....	144-148	128
Antimechanized.....	149-153	132
Chemical warfare.....	154-158	138
Individual.....	137	125
Motor transport.....	136	125
Definitions:		
Antimechanized defense.....	149	132
Motor march.....	51	35
Motor transport.....	1	1
Traffic management.....	76	75
Traffic reconnaissance.....	86	78
Density, column.....	122	107
Descending steep slopes.....	190	169
Detonating caps.....	160	142
Detrucking.....	61, 127	57, 112
Difficult operations:		
Ascending steep slopes.....	189	167
Bog.....	192	172
Bridges.....	200	176
Deep streams.....	199	175
Descending steep slopes.....	190	169
Ditches.....	197	174
Factors.....	188	167
Fording.....	198	176
Frozen streams.....	134, 195	124, 173
Gumbo.....	193	172

INDEX

	Paragraph	Page
Difficult operations—Continued.		
Ice.....	196	173
Muddy roads.....	191	169
Overtured vehicle.....	203	177
Points to be observed.....	187	166
Practice.....	45	32
Ravines.....	197	174
Sand.....	194	172
Slippery curves.....	201	176
Snow.....	196	173
Swamps.....	192	172
Towed load.....	202	177
Disabled vehicles.....	66, 220	66, 209
Discipline, march column.....	60	53
Ditches.....	197	174
Drivers:		
Aptitude test.....	App. IX	249
Assignment.....	6	2
Examination.....	48	34
Instruction. (See Instruction.)		
Maintenance. (See Maintenance.)		
Operator's permit.....	49	34
Selection.....	8	5
Training.....	7, App. II	5, 227
Echelons. (See Maintenance.)		
Entrucking.....	61, 127	57, 112
Equipment:		
Maintenance.....	218	207
Pioneer party.....	173	150
Traffic reconnaissance.....	90	81
Escorts.....	111	92
Evacuation, civilian.....	82	76
Examination.....	48	34
Explosives and inflammable liquids:		
Caps.....	160	142
Dispersion.....	159	142
Handling.....	162	143
Leakage.....	163	144
Protection from sparks and fires.....	161	142
Regulations.....	App. V	242
Fan belt.....	186	166
Field expedients.....	175-186	157
Flank guard.....	169	147
Fording.....	183, 198	123, 175
Fourth echelon.....	214	204
Fuze, light.....	186	166
G-4, traffic planning.....	99	86
Gages.....	38	24
Gasoline, shipment.....	App. V	242
Gear, shifting.....	41	27
Graph, march.....	129	114
Guards:		
Advance.....	168	146
Flank.....	169	147
Rear.....	170	148
Gumbo.....	193	172

INDEX

	Paragraph	Page
Halt -----	62, 110	60, 92
Ice:		
Carrying capacity -----	134, 195	124, 173
Traction -----	196	173
Ignition system, wet -----	186	166
Infiltration -----	56	43
Inflammable liquids. (See Explosives and inflammable liquids.)		
Information:		
Traffic plan -----	98	85
Traffic reconnaissance -----	88, 89	79, 80
Inspections:		
Driver's:		
After operation -----	34	23
At halt -----	33	23
Before operation -----	31	21
During operation -----	32	22
Duties during scheduled -----	28	20
System -----	228	216
Vehicles shipped by rail or water -----	App. VI	245
Instruction:		
Driving:		
Aids to control -----	37	24
Backing -----	44	30
Brakes -----	43	29
Clutch -----	41	27
Controls -----	36	24
Difficult operations. (See Difficult operations.)		
Gear shifting -----	41	27
General rule -----	35	23
Instrument board gages -----	38	24
Manipulation of controls -----	40	26
Marching -----	47	33
Night -----	46	33
Parking -----	44	30
Schedules -----	App. II	227
Starting engine -----	39	24
Transmission -----	42	28
Turning -----	44	30
Preliminary:		
Accident prevention -----	12	7
Chains -----	16	11
Fire prevention -----	11	6
Loads -----	18	12
Map reading -----	19	14
Motor park -----	10	6
Nomenclature -----	13	7
Responsibility -----	9	6
Road rules -----	15	9
Signals -----	14	7
Traction devices -----	16	11
Traffic regulations -----	15	9
Winch -----	17	12
Traffic reconnaissance -----	91	81
Instrument board gages -----	38	24

INDEX

	Paragraph	Page
Loading and unloading:		
Rail movements.....	231-232	223
Time.....	126	112
Water movements.....	233-237	224
Loads	18	12
Logistical data:		
Civilian authorities, coordination.....	132	121
Commanders of small units.....	118	103
Density of motor columns.....	122	107
Entrucking and detrucking.....	61, 127	57, 112
Hauling capacity.....	124	110
Ice, carrying capacity.....	134	124
Loading and unloading time.....	126	112
March day.....	119	103
March graphs and tables.....	129, 130	114, 118
Nomograph.....	128	114
Rates of march.....	119	103
Road spaces.....	121, 123	106, 110
Shuttle movements.....	131	121
Size and weights.....	120	106
Time length.....	122	107
Traffic flow.....	122	107
Troop capacity.....	125	110
Water, fordable depths.....	133	123
Lubrication:		
Application.....	226	216
First echelon.....	22	16
Importance.....	222	210
Lubricants.....	225	213
Methods.....	223	210
Records.....	227	216
Schedules.....	224	212
Maintenance:		
Basic principles.....	204	179
Drivers':		
Care:		
Storage battery.....	27	19
Tires.....	26	18
Tools.....	25	18
Cleaning.....	24	17
Duties during inspection.....	28	20
Emergency repairs.....	30	21
Inspection:		
After operation.....	34	23
At halt.....	33	23
Before operation.....	31	21
During operation.....	32	22
Lubrication.....	22	16
Preventive.....	20	14
Reports.....	29	20
Servicing.....	21	15
Tightening.....	23	17
Echelons:		
Company or battery and regimental second echelon repair.....	212	201
First.....	210	193
Fourth.....	214	204
Second.....	211	193

INDEX

	Paragraph	Page
Maintenance—Continued.		
Echelons—Continued.		
Theater of operations.....	215	206
Third.....	213	201
Lubrication. (See Lubrication.)		
March:		
Abandoning vehicles.....	221	209
Equipment.....	218	207
Organization.....	65	65
Personnel.....	217	207
Problems.....	216	207
Repair procedure.....	219	208
Spare parts and units.....	218	207
Towing.....	220	209
Organization:		
Factors.....	205	180
March.....	65	65
Personnel.....	208	183
Supply.....	209	191
Types.....	206	181
Maps:		
Reading.....	19	14
Traffic:		
Symbols.....	115	98
Types.....	114	95
March:		
Accidents.....	70	68
Cold weather.....	71	70
Command.....	52	38
Control.....	60	53
Definitions.....	51	35
Disabled vehicles.....	66	66
Entrucking and detrucking.....	61, 127	57, 112
Graphs and tables.....	129	114
Halts.....	62, 110	60, 92
Logistical data. (See Logistical data.)		
Maintenance. (See Maintenance.)		
Messing.....	67	66
Night.....	68	67
Orders.....	72-75	71
Organization.....	53	39
Passage of columns.....	109	91
Refueling.....	64	64
Reversing direction.....	63	62
Security.....	54	41
Types:		
Close column.....	57	46
Column movement.....	55	41
Infiltration.....	56	43
Open column.....	58	48
Shuttling.....	59	52
Markers, route.....	108, 116, 117	90, 100
Mechanized units. (See Antimechanized defense.)		
Messing.....	67	66
Mines:		
Protection from.....	142	127
Use.....	150	132
Mission, pioneer.....	172	150

INDEX

	Paragraph	Page
Motor park-----	10	6
Mud-----	191	169
Night—		
Driving-----	46	33
Marches-----	68	67
Operations, planning-----	103	87
Nomenclature, instruction-----	13	7
Nomograph-----	128	114
Obstacles, antimechanized-----	150	132
Obstruction, traffic-----	92	82
Odometers-----	60	53
Operator's permit-----	49	34
Orders:		
March-----	75	71
Plans-----	74	71
Reconnaissance, prior-----	73	71
Traffic-----	104	88
Warning-----	72	71
Organization, motor march-----	75	71
Outposts-----	171	149
Overturned vehicles-----	203	177
Parking-----	44	30
Passage of columns-----	109	91
Patrols:		
Advance reconnaissance-----	167	144
Traffic-----	112	94
Permit, operator's-----	49	34
Personnel:		
Drivers, selection-----	8	5
Maintenance-----	208, 217	183, 207
Traffic reconnaissance-----	87, 91	78, 81
Pioneer parties:		
Duties-----	174	152
Equipment-----	173	150
Mission-----	172	150
Plan, traffic. (See Traffic management.)		
Preventive maintenance-----	6, 20	2, 14
Protection, measures:		
Application-----	135	125
Blackouts-----	140	127
Camouflage-----	138	125
Communications-----	139	126
Individual-----	137	125
Mines-----	142	127
Motor transport-----	136	125
Tires-----	141	127
Warning signals-----	143	128
Publications-----	App. I	226
Radiator leak-----	186	166
Ravines-----	197	174
Rear guard-----	170	148
Reconnaissance:		
Advance patrols-----	167	144
Chemical operations-----	156	139

INDEX

Reconnaissance—Continued.		Paragraph	Page
Traffic:			
Bridges.....	94		83
Congested areas.....	95		84
Directives.....	91		81
Equipment.....	90		81
Information:			
Required.....	88		79
Sources.....	89		80
Obstruction.....	92		82
Personnel.....	87		78
Purpose.....	86		78
Reports.....	96		85
Road classification.....	115		98
Records and reports.....	229, 230	219,	220
References.....	App. I		226
Refueling.....	64		64
Regulations, explosives and gasoline.....	App. V		242
Repairs:			
Emergency, roadside.....	30, 186	21,	166
Procedure on march.....	219		208
Second echelon.....	212		201
Reports:			
Driver's.....	29		20
Inspection of vehicles shipped by rail or water.....	App. VI		245
Status of motor vehicles.....	App. VII		247
Traffic reconnaissance.....	96		85
Responsibility, driver's.....	9		6
Reversing direction.....	63		62
Road—			
Blocks.....	69		68
Rules.....	15		9
Test procedure.....	App. III		235
Routes:			
Classification.....	102		87
Indication method.....	116		100
Marking.....	108		90
Sand.....	194		172
Schedules:			
Driver training.....	App. II		227
Traffic.....	101		86
Second echelon.....	211		193
Security, antimechanized.....	152		137
Security detachments:			
Advance guard.....	168		146
Advance reconnaissance.....	167		144
Duties.....	164		144
Economy of force.....	166		144
Flank guards.....	169		147
Outposts.....	171		149
Rear guards.....	170		148
Types.....	165		144
Selection of drivers.....	8		5
Servicing.....	21		15
Shifting gear.....	41		27
Shuttling.....	59, 131	52,	121

INDEX

	Paragraph	Page
Signals:		
Driving.....	14	7
Warning.....	143	128
Skidding.....	201	176
Snow.....	196	173
Spaces, road:		
At halt.....	121	106
Average.....	123	110
Spare parts.....	209, 218	191, 207
Speed limits.....	6	2
Spreader bars.....	179	161
Spring leaves.....	186	166
Steep slopes.....	189, 190	167, 169
Streams:		
Deep.....	199	175
Frozen.....	134, 195	124, 173
Shallow.....	198	175
Supply for maintenance.....	209	191
Swamps.....	192	172
Tables, march.....	129, 130	114, 118
Tackle.....	181	163
Theater of operations, echelon system.....	215	206
Third echelon.....	213	201
Tightening.....	23	17
Time length, column.....	122	107
Tires.....	26, 141	18, 127
Tools.....	25	18
Traction devices.....	16, 175	11, 157
Traffic management:		
Agencies involved.....	81	76
Characteristics.....	79	76
Civilian evacuation.....	82	76
Coordination.....	80	76
Definition.....	76	75
Elements:		
Capacity of route.....	84	77
Conflicts, control.....	85	77
Factors.....	83	77
Logistical data. (See Logistical data.)		
Maps.....	114, 115	95, 98
Objective.....	78	75
Plan:		
Commanding officer.....	97	85
Execution:		
Commanders of small units.....	105	89
Escorts.....	111	92
Halts.....	110	92
Markers, route.....	108	90
Night operation.....	113	94
Passage of columns.....	109	91
Patrols.....	112	94
Personnel.....	107	90
Systems.....	106	89
Information needed.....	98	85
Night operations.....	103	87
Orders.....	104	88
Responsibility.....	99	86
Route classification.....	102	87

INDEX

	Paragraph	Page
Traffic management—Continued.		
Plan—Continued.		
Schedules.....	101	86
Systems.....	106	89
Reconnaissance. (See Reconnaissance.)		
Regulations, instruction.....	15	9
Route indication.....	116	100
Signs.....	117	100
Trail officers.....	60	53
Training, driver's.....	7	5
Transmission.....	42	28
Turning:		
Practice.....	44	30
Towed load.....	202	177
Tow—		
Bars.....	182	163
Chains or cables.....	178	160
Ropes.....	180	161
Towing.....	220	209
Warm-up, engine.....	39	24
Warning—		
Service.....	145	129
Signals.....	143	128
Water, fordable depths.....	133	123
Weapons, antimechanized.....	151	136
Wheel mats.....	177	160
Winch.....	17	12
Winch truck.....	176	157
Wrecking cranes.....	176	157

