

MHI  
Copy 3

# FM 7-10

DEPARTMENT OF THE ARMY FIELD MANUAL

---

PROPERTY OF  
LIBRARY

**RIFLE COMPANY  
INFANTRY AND AIRBORNE  
DIVISION BATTLE GROUPS**

PROPERTY OF  
LIBRARY

---

HEADQUARTERS, DEPARTMENT OF THE ARMY  
JANUARY 1959

**FIELD MANUAL**  
**RIFLE COMPANY**  
**INFANTRY AND AIRBORNE**  
**DIVISION BATTLE GROUPS**

FM 7-10

CHANGES No. 1

HEADQUARTERS,  
 DEPARTMENT OF THE ARMY  
 WASHINGTON 25, D.C., 18 May 1961

FM 7-10, 29 January 1959, is changed as follows:

**15. General Considerations Under Nuclear Warfare Conditions**

\* \* \* \* \*

*d.* Emphasis is placed \* \* \* nuclear weapons effects. Protective measures which may be taken by individuals and/or units include frequent and rapid movement, use of camouflage and concealment, operations during periods of low visibility, deception, and use of enplacements, personnel carriers, and individual protective measures to reduce exposure to nuclear weapons effects.

*e.* Rescinded.

\* \* \* \* \*

**44. Concept of Offensive Operations**

\* \* \* \* \*

*b.* (9) Rescinded.

\* \* \* \* \*

## 47. Assembly Areas

Prior to the attack, the company may occupy an assembly area, the location of which is normally designated by the battle group commander. In the assembly area, elements of the company are dispersed to the maximum extent practicable to reduce vulnerability to enemy fires. Every advantage is \* \* \* enemy armor attack.

\* \* \* \* \*

## 55. Plan for Reorganization and Consolidation (Superseded)

a. The company commander prepares plans for the reorganization and consolidation after seizure of an objective. These plans, announced in the attack order, are necessarily tentative and may be changed as required during the conduct of the attack.

b. The company commander consolidates a newly captured position by organizing and strengthening the newly captured position so that it can be used against the enemy. His plan for consolidation includes the responsibilities of rifle platoons for defending assigned areas, the designation of general position areas and missions for organic and attached weapons and tanks, the use of patrols to maintain contact with the enemy, and security measures. His plan also may designate contact points between platoons to further delineate areas of platoon responsibility. The platoon areas assigned for consolidation normally block enemy approaches to the objective.

c. Reorganization is the restoration of order in a unit accomplished by replacing casualties (if pos-

sible); reassigning men if necessary; replenishing the ammunition supply; and performing whatever other actions are necessary or possible in order to prepare the unit for further operations against the enemy. This plan for reorganization includes such other items as special instructions regarding ammunition resupply, vehicular movement, reporting of casualties, and the movement and general location of the command post.

### **63. Action Following Seizure of an Objective** (Superseded)

*a.* The company commander reports the seizure of the objective to the battle group commander. Consolidation starts as soon as the objective has been seized. Plans announced in the attack order are revised as necessary. If appropriate, the company commander prepares to continue the attack.

*b.* Reorganization is continuous throughout the attack. It includes the reassignment of personnel to key jobs made vacant by casualties, reestablishment of the chain of command, and redistribution of ammunition. During reorganization after seizure of the objective, strength and ammunition status are reported to the battle group commander. Ammunition is brought forward and issued as required, and casualties are evacuated. Enemy information is reported and prisoners are sent to collecting points.

*c.* Consolidation of an objective is the organization of the ground for defense. Troops and weapons are positioned as rapidly as possible, since the enemy may counterattack soon after seizure of the objective.

During the consolidation, organic and attached weapons are moved forward rapidly and integrated into the overall plan for the defense of the objective area. Possible routes of enemy counterattack are covered by direct and indirect fire.

*d.* To prevent surprise, patrols operate to the front and flanks to maintain contact with the enemy and with adjacent units.

*e.* The company commander may use his reserve in the consolidation by positioning it to block an exposed flank or to extend the depth of the defense.

## **92. Conduct of the Attack**

\* \* \* \* \*

*j.* Upon seizing the objective, reorganization and consolidation are accomplished in much the same way as in a dismounted attack.

\* \* \* \* \*

## **95. Conduct of the Attack**

\* \* \* \* \*

*e.* The conduct of the attack, reorganization, and consolidation of the reserve company are carried out as discussed in section V, this chapter.

\* \* \* \* \*

## **105. Plan for Reorganization and Consolidation**

This plan is generally the same as for a daylight attack. The phase line normally prescribed by the battle group commander will restrict the area in which elements of the company can be positioned. Because of reduced \* \* \* during the reorganization.

## **107. Conduct of the Attack**

\* \* \* \* \*

i. Once the objective has been seized, platoons move to designated areas and consolidate. Squad and platoon \* \* \* reorganization and consolidation.

\* \* \* \* \*

#### 111. Planning a Crossing Using Boats

\* \* \* \* \*

##### g. Rescinded.

\* \* \* \* \*

#### 122. Basic Considerations of Defense

\* \* \* \* \*

j. (Superseded) *Dispersion*. The company commander must insure that individuals are sufficiently dispersed to avoid excessive casualties from enemy fires. At company level, no attempt is made to disperse as a passive defense measure against nuclear weapons since such dispersion would weaken the company's effectiveness disproportionately to the protection gained.

#### 144. Conduct of the Defense During Daylight

##### a. Rescinded.

\* \* \* \* \*

#### 150. Conduct

\* \* \* \* \*

d. (Superseded) Patrols are used to maintain contact with the enemy. The company is alert for any withdrawal of the enemy force. Should such a substantiated withdrawal occur, the company must be prepared for immediate redeployment on order of the battle group commander.

## 200. Conduct of the Attack

The conduct of \* \* \* the airborne assault. Upon seizure of initial objectives, elements of the company redispense themselves to defend the airhead line or take such other action as is indicated by the assigned mission.

BY ORDER OF THE SECRETARY OF THE ARMY:

G. H. DECKER,  
*General, United States Army,*  
*Chief of Staff.*

Official:

R. V. LEE,  
*Major General, United States Army,*  
*The Adjutant General.*

Distribution:

*Active Army:* To be distributed in accordance with DA Form 12-7 requirements for FM 7-series (Unclass); plus the following:

DCSOPS (2)	Bde (1)
ACSRC (2)	Regt/Gp/bg (5)
Seventh USA (5)	CC (5)
EUSA (5)	Bn (5)
Corps (3)	Co/Btry (5)
Div (2)	

*NG:* State AG (3); units—same as active army except allowance is three copies to each unit.

*USAR:* Same as active army except allowance is one copy to each unit.

For explanation of abbreviations used, see AR 320-50.

FIELD MANUAL HEADQUARTERS,  
DEPARTMENT OF THE ARMY  
No. 7-10 WASHINGTON 25, D. C., 29 January 1959

## RIFLE COMPANY, INFANTRY AND AIRBORNE DIVISION BATTLE GROUPS

	Paragraphs	Page
<b>CHAPTER 1. GENERAL</b>		
Section I. Introduction .....	1-4	7
II. Organization and duties, rifle company, infantry division battle group.....	5-8	8
III. Organization and duties, rifle company, airborne division battle group....	9-12	17
IV. Operations, general .....	13-18	22
V. Intelligence .....	19-23	28
VI. Communication .....	24-27	36
<b>CHAPTER 2. TACTICAL MOVE- MENTS</b>		
Section I. General .....	28-33	45
II. Tactical foot marches.....	34-39	48
III. Tactical motor or mech- anized movements .....	40-42	59

\*This manual supersedes FM 7-10, 3 October 1949, including C 1, 16 October 1950; C 2, 18 October 1951; C 3, 3 December 1952; and C 4, 18 November 1955; and TC 7-2, 14 January 1957. Except for units organized under TOE 7-17C will continue to use FM 7-10, October 1949; and TC 7-2, January 1957, until such time as recognized under TOE 7-17D.



	Paragraphs	Page
<b>CHAPTER 3. OFFENSE</b>		
Section I. General .....	43-45	65
II. Preparation for the at- tack .....	46-48	67
III. Plan of maneuver .....	49-56	70
IV. Fire planning and co- ordination .....	57, 58	86
V. Conduct of the attack.....	59-64	92
VI. Rifle platoon .....	65-71	100
VII. Weapons platoon .....	72-74	122
VIII. Infantry-tank team .....	75-81	135
IX. Mechanized rifle company in attack .....	82-93	145
X. Reserve rifle company.....	94, 95	160
XI. Night attack .....	96-107	162
XII. River crossings .....	108-112	180
XIII. Task force operations.....	113-116	198
XIV. Raids .....	117-119	204
 <b>CHAPTER 4. DEFENSE</b>		
Section I. General .....	120-123	211
II. Security forces .....	124-129	216
III. Forward rifle company— planning and organiza- tion of defense.....	130-142	223
IV. Conduct of the defense, forward rifle company	143-146	269
V. Perimeter defense .....	147-150	276
VI. Reverse slope defense.....	151-153	281
VII. Defense of a riverline.....	154-156	286
VIII. Reserve rifle company.....	157-161	290
IX. Relief in place.....	162-165	295
 <b>CHAPTER 5. RETROGRADE                   MOVEMENTS</b>		
Section I. General .....	166-170	300
II. Night withdrawal .....	171-175	309
III. Daylight withdrawal .....	176-179	317
IV. Delaying actions .....	180-184	324

	Paragraphs	Page
<b>CHAPTER 6. AIRBORNE OPERATIONS</b>		
Section I. General .....	185, 186	331
II. Airborne assault .....	187-201	333
III. Withdrawal by air .....	202-207	353
<b>CHAPTER 7. ADMINISTRATION AND LOGISTICS</b>		
Section I. Personnel management and administration .....	208, 209	363
II. Combat supply, rifle company, infantry division, battle group .....	210-215	367
III. Combat supply, rifle company, airborne division battle group .....	216-219	374
IV. Miscellaneous logistical activities .....	220-222	378
<b>APPENDIX I. REFERENCES</b> .....		381
II. ESTIMATE OF THE SITUATION .....		386
III. TROOP LEADING PROCEDURE .....		389
IV. OPERATION ORDERS .....		397
V. COMBAT FORMATIONS .....		431
VI. BATTLE DRILL .....		433
<b>INDEX</b> .....		468



# CHAPTER 1

## GENERAL

---

### Section 1. INTRODUCTION

#### 1. Purpose and Scope

*a.* This manual is a guide to the tactical employment of the rifle company, infantry division battle group, and the rifle company, airborne division battle group.

*b.* The tactics, techniques, and procedures described are intended for guidance and should not be considered as a set of inflexible rules. Varying conditions of the battlefield require the intelligent application of the doctrine stated herein. Existing conditions may require modification of specific tactics and techniques in order to achieve optimum results.

*c.* The material contained herein is applicable to nuclear and nonnuclear warfare.

*d.* With few exceptions, the material presented in chapters 2 through 6 applies equally to the rifle companies of both the infantry and airborne division battle groups. Minor organizational and equipment differences between the two rifle companies do not affect the basic guidance. For a

discussion of modification applicable to the rifle company, airborne division battle group, see paragraph 13.

## **2. Mission**

*a.* The mission of the rifle company, infantry and airborne division battle groups, is to close with the enemy by means of fire and maneuver in order to capture or destroy him.

*b.* The specific mission assigned the company will vary depending upon the nature of the operation.

## **3. Capabilities**

*a.* The rifle company, infantry and airborne division battle groups, are capable of:

- (1) Closing with the enemy by means of fire and maneuver in order to capture or destroy him.
- (2) Repelling enemy assault by fire, close combat, and counterattack.
- (3) Providing a base of fire and maneuver.
- (4) Seizing and holding terrain.
- (5) Maneuvering in all types of terrain and climatic conditions.
- (6) Participating in airborne assaults as an air-landed force.
- (7) Making withdrawals by air.

*b.* In addition to the capabilities enumerated in *a* above, the rifle company, airborne division

battle group, is capable of making airborne assaults by parachute.

#### **4. Characteristics**

a. Infantry is an arm of close combat. It fights by combining fire, maneuver, and shock action. Infantry is the only force capable of seizing and holding terrain for extended periods. Because of its extreme versatility, it is capable of fighting under widely varying conditions of terrain and weather in either a nuclear or a nonnuclear war. The organization, equipment, and training of infantry units permit the use of a variety of means of surface and air transportation.

b. The rifle company is the basic tactical element of the battle group. Its organization and equipment provide it with the necessary means to conduct normal combat operations. When increased combat power is required for specific tasks, the company is capable of receiving and controlling additional combat support elements. When suitably reinforced, the rifle company is capable of independent operations for limited periods. While the inherent mobility of the company is that of the foot soldier, it can be readily adapted to permit use of personnel carriers, trucks, and aircraft to increase its tactical mobility. The rifle company is completely transportable in helicopters, medium assault aircraft, or medium transport aircraft.

## Section II. ORGANIZATION AND DUTIES, RIFLE COMPANY, INFANTRY DIVISION BATTLE GROUP

### 5. Organization

The rifle company, infantry division battle group, consists of a company headquarters, four rifle platoons, and a weapons platoon (fig. 1).

*a. Company Headquarters.* Personnel of company headquarters include those who control or assist in control of the company (command group) and those who provide administrative, supply, and service support (service group). The command group normally consists of the company commander, executive officer, first sergeant, communication chief, radiotelephone operators, wiremen, and messenger. The service group normally consists of the mess personnel, supply sergeant, armorer, and company clerk. The  $\frac{1}{4}$ -ton truck with trailer organic to company headquarters, carries the vehicular-mounted radio of the company and is normally used as the company commander's command and reconnaissance vehicle.

*b. Rifle Platoon.* This element consists of a platoon headquarters, three rifle squads, and a weapons squad (fig. 1). The platoon headquarters consists of the platoon leader, platoon sergeant, and messenger. Each rifle squad consists of a squad leader and two five-man fire teams which are designated the ALFA team and BRAVO team. Each fire team has a fire team leader, an automatic rifleman and three riflemen.

The weapons squad has a squad leader, 2 machinegunners, 2 assistant machinegunners, 2 rocket gunners, 2 assistant rocket gunners, and 2 ammunition bearers. The weapons squad is organized into ALFA and BRAVO machinegun teams and ALFA and BRAVO rocket launcher teams.

*c. Weapons Platoon.* The weapons platoon consists of a platoon headquarters, 2 antitank squads, and three 81-mm mortar squads (fig. 1). In the platoon headquarters are the platoon leader, platoon sergeant, 3 forward observers, 3 fire direction computers, 4 radiotelephone operators, and a messenger. Each antitank squad consists of a squad leader, gunner, loader, and light truck driver. Each mortar squad consists of a squad leader, gunner, assistant gunner, and two ammunition bearers. One 1/4-ton truck and one 3/4-ton truck, each with trailer, are organic to the platoon headquarters. One 1/4-ton truck is organic to each antitank squad, and one 3/4-ton truck with trailer is organic to each mortar squad. For more details of the organization and equipment of the rifle company, infantry division battle group, see TOE 7-17T ROCID.

## **6. Duties of Company Headquarters Personnel**

### *a. Company Commander.*

- (1) The company commander is responsible for the training, discipline, control, administration, and welfare of his company and for all aspects of its performance in garrison and in combat.



- (2) The company commander trains his subordinate leaders and utilizes them to the maximum in accomplishing his mission. He actively supervises the performance of those under his command and takes positive action to correct any deficiencies. He strives to develop in his subordinate leaders such qualities as initiative, self-reliance, ingenuity, and professional competence by furnishing sound guidance and then allowing them maximum freedom of action in accomplishing their assigned tasks.
- (3) In combat, the company commander makes sound tactical decisions on the employment of his unit based on orders from higher headquarters and on a thorough estimate of the situation. He keeps informed of the situation at all times by aggressively searching for information. He goes where he can best influence the action of his company, and he exerts his personal leadership to influence the outcome of the action. When a situation exists which is beyond the capability of his unit, he requests assistance from higher headquarters. In the absence of orders, as when communication with higher headquarters is lost, he makes decisions on the employment of the company based on his understanding of the overall mission and on his estimate of the situation.

b. *Executive Officer.* The executive officer per-

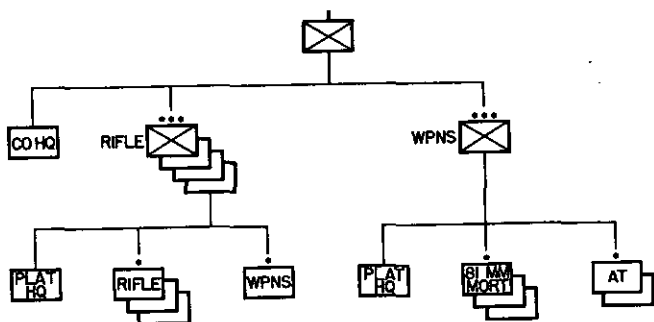

Figure 1. Rifle company, infantry division battle group.

forms duties assigned to him by the company commander. He keeps abreast of the tactical situation and assumes command of the company in the absence of the company commander. He takes charge of the command post and maintains communication with elements of the company and with the company and battle group commanders. He notifies appropriate commanders of the change in the command post location. He controls the movement of vehicles within the company area and supervises the supply of ammunition to the platoons. He is charged with supervision of company administration, service, and supply. In garrison, he is normally charged with responsibility for company property other than that issued to the platoons.

c. *First Sergeant.* The first sergeant assists the company commander by executing assigned duties. He makes recommendations to the company commander on such items as appointments,

reductions, assignments, and disciplinary matters as they pertain to the enlisted members of the company. Ordinarily, he assists the executive officer and represents him during his temporary absence from the command post.

*d. Communication Chief.* The communication chief supervises the installation, operation, and maintenance of the company communication system and assists in procuring signal supplies. He advises the company commander on matters pertaining to communication security, and he disseminates appropriate information contained in current communication orders (SOI and SSI). He supervises the radiotelephone operators, wiremen, and the company messenger in the performance of their communication duties. He conducts communication training as directed by the company commander.

*e. Radiotelephone Operators.* The two radiotelephone operators operate and maintain the radios of company headquarters. They are trained to operate all of the communication equipment of the company. Normally one radiotelephone operator is utilized in the command post, while the other accompanies the company commander. One of the radiotelephone operators is also a light truck driver.

*f. Wiremen.* The two wiremen install and maintain the company wire system, assisted by other personnel as necessary. They are trained to operate all of the communication equipment of the company.

*g. Messenger.* The messenger is trained to carry written or verbal messages under all conditions and to install, operate, and maintain all items of communication equipment in the company.

*h. Mess Personnel.* The mess steward is responsible for the operation of the company mess. He supervises the cooks and cooks' helpers in the preparation, cooking, and serving of food. For a detailed discussion of the operation of the mess, see TM 10-405.

*i. Supply Sergeant.* The supply sergeant requests, receives, issues, stores, maintains, and turns in supplies and equipment for the company (except rations and water) in accordance with current regulations and policies. Under the supervision of the company commander or his designated representative, he prepares and maintains required supply records. He supervises the company armorer.

*j. Armorer.* The armorer performs second echelon maintenance on the weapons of the company. He assists the supply sergeant in the handling of supplies.

*k. Company Clerk.* The company clerk performs necessary clerical duties under the supervision of the first sergeant. He also delivers incoming mail and collects and processes outgoing mail.

## **7. Duties of Rifle Platoon Personnel**

*a. Platoon Leader.* The platoon leader is responsible for the discipline, training, control, and

tactical employment of his platoon. His duties to his platoon are the same as are the company commander's duties to the company (par. 6a). In addition, he has responsibility for all equipment issued to his platoon.

*b. Platoon Sergeant.* The platoon sergeant performs duties assigned him by the platoon leader. Primarily he assists in the control of the platoon and supervises the supply of ammunition. He assumes command in the absence of the platoon leader.

*c. Rifle Squad Leaders.* The rifle squad leader is responsible for the discipline, training, control, and tactical employment of his squad. He utilizes his fire team leaders to assist him primarily in control.

*d. Fire Team Leaders.* Fire team leaders are fighter leaders who assist the squad leader in control of the squad in combat primarily by initiating the action directed by the squad leader and by setting the example for their team members as indicated by the situation. They provide such additional assistance as may be directed by the squad leader. The senior fire team leader assumes command of the squad in absence of the squad leader.

*e. Rifle Squad Members.* Riflemen and automatic riflemen are trained to be proficient in individual as well as team combat action. Their specific tasks are specified by the squad leader or team leader, as appropriate. The number 6 and number 11 men are normally designated to carry additional ammunition for the automatic

riflemen (numbers 4 and 9, respectively). See appendix V.

*f. Weapons Squad Leader.* The weapons squad leader is responsible for the discipline, training, and control of his squad, and, based on instructions from the platoon leader, for its tactical employment. He normally makes recommendations to the platoon leader for the tactical employment of his squad.

*g. Weapons Squad Members.* Machinegunners and rocket gunners employ their assigned weapons as directed by the weapons squad leader. They control the fire of their weapons and the displacement of their teams as directed. The senior gunner assumes command of the squad in the absence of the squad leader. Assistant gunners assist in the employment of their respective weapons. Ammunition bearers resupply ammunition for the machineguns and/or rocket launchers as directed and are prepared to replace members of either the machinegun or rocket launcher teams in the event of casualties.

*h. Messenger.* The messenger assists the platoon leader in control by delivering oral or written messages and performing such other tasks as are directed by the platoon leader. See paragraph 6g.

## **8. Duties of Weapons Platoon Personnel**

*a. Platoon Leader.* The platoon leader is responsible for the training, discipline, and control of his platoon. He normally makes recommendations to the company commander on the employ-

ment of elements of his platoon and assists the company commander in fire support planning. His duties to his platoon are the same as are the company commander's duties to the company (par. 6a). In addition, he has responsibility for all equipment issued to his platoon.

*b. Platoon Sergeant.* The platoon sergeant performs duties assigned him by the platoon leader. Primarily he assists in the control of the platoon, supervises ammunition resupply, and supervises use of the platoon's transportation. He assumes command of the platoon in the absence of the platoon leader.

*c. Forward Observers.* These personnel observe and adjust fire of the mortar squads, and under certain circumstances, of artillery units.

*d. Fire Direction Computers.* The fire direction computers prepare the necessary firing data for the mortars.

*e. Radiotelephone Operators.* These individuals operate and maintain the radios utilized in the fire direction net. Normally one radiotelephone operator operates in the fire direction center, while one operator accompanies each forward observer. They also operate telephones and related equipment when appropriate. Two radiotelephone operators are also light truck drivers.

*f. Messenger* See paragraphs 6g and 7h.

*g. Antitank Squad Personnel.* The antitank squad leader is responsible for the discipline, training, and control of his squad and, based on instructions from the platoon leader, for its

tactical employment. Specifically, he selects exact firing positions for his squad, designates targets, controls fire, and supervises displacement. For additional discussion of duties of squad members, see FM 23-82.

*h. 81-mm Mortar Squad Personnel.* The mortar squad leader is responsible for the discipline, training, and control of his squad and, based on instructions from the platoon leader, for its tactical employment. Specifically, he selects exact firing positions for his squad, controls fire, and supervises displacement. The senior mortar squad leader may be designated to supervise all mortar squads when firing from a central location. One of the ammunition bearers is also a light truck driver. For additional discussion of duties of squad members, see FM 23-90.

### **Section III. ORGANIZATION AND DUTIES, RIFLE COMPANY, AIRBORNE DIVISION BATTLE GROUP**

#### **9. Organization**

The rifle company, airborne division battle group, consists of a company headquarters, four rifle platoons, and a weapons platoon (fig. 2).

*a. Company Headquarters.* Personnel of company headquarters include those who control or assist in control of the company (command group) and those who provide administrative, supply, and service support (service group). The



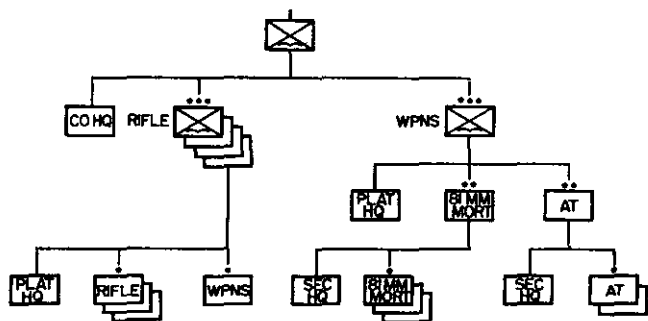

Figure 2. Rifle company, airborne division battle group.

command group normally consists of the company commander, executive officer, first sergeant, communication chief, and a radiotelephone operator. The service group normally consists of the mess personnel, company clerk, and unit supply specialist. The  $\frac{1}{4}$ -ton truck organic to company headquarters carries the vehicular mounted radio of the company and is normally used as the company commander's command and reconnaissance vehicle. The two infantry light weapons carriers are used to carry equipment and supplies.

*b. Rifle Platoon.* The rifle platoon consists of a platoon headquarters, three rifle squads, and a weapons squad (fig. 2). The platoon headquarters consists of the platoon leader, platoon sergeant, and a radiotelephone operator. For organization of the rifle squads and weapons squad, see paragraph 5b. One infantry light weapons carrier is organic to the weapons squad.

*c. Weapons Platoon.* The weapons platoon consists of a platoon headquarters, an 81-mm mortar

section, and an antitank section (fig. 2). In the platoon headquarters are the platoon leader, platoon sergeant, and a radiotelephone operator. The 81-mm mortar section headquarters consists of a section leader, 3 forward observers, 3 fire direction computers, and 4 radio telephone operators. Each of the three 81-mm mortar squads contains a squad leader, gunner, assistant gunner, and two ammunition bearers. The antitank section headquarters consists of a section leader and an ammunition handler, while each of the 2 antitank squads contains a squad leader, gunner, loader, and a light truck driver. Organic transportation of the platoon is located as follows: 1 infantry light weapons carrier in each 81-mm mortar squad; 1 infantry light weapons carrier in the antitank section headquarters; and 1 infantry light weapons carrier in each antitank squad.

*d. Reference.* For a more detailed analysis of the organization and equipment of the rifle company, airborne division battle group, see TOE 7-37D.

## **10. Duties of Company Headquarters Personnel**

*a. General.* For duties of the company commander, executive officer, first sergeant, communication chief, radiotelephone operator, company clerk, and mess personnel, see paragraph 6. The company clerk, unit supply specialist, and radiotelephone operator are also light truck drivers.

*b. Unit Supply Specialist.* The unit supply

specialist requests, receives, issues, stores, maintains, and turns in supplies and equipment for the company in accordance with current regulations and policies. Under the supervision of the company commander or his designated representative, he prepares and maintains required supply records and operates an informal supply control point for the company.

## **11. Duties of Rifle Platoon Personnel**

*a. General.* For duties of the platoon leader, platoon sergeant, and members of the rifle and weapons squads, see paragraph 7. One enlisted man in the weapons squad is also the light truck driver.

*b. Radiotelephone Operators.* The radiotelephone operator operates and maintains the radio in the company command net. He is trained to operate all communication equipment utilized by the platoon.

## **12. Duties of Weapons Platoon Personnel**

*a. General.* For duties of the platoon leader, platoon sergeant, forward observers, and fire direction computers, see paragraph 8.

*b. Radiotelephone Operator.* The radiotelephone operator of platoon headquarters operates and maintains the radios in the company and platoon command nets. In moving situations, he requires assistance for one of the radios. The operators of the 81-mm mortar section headquarters operate the radios in the fire direction center net; one operator accompanies each of the

forward observers. All radiotelephone operators are trained to use all communication equipment utilized by the platoon.

*c. Section Leaders.* The 81-mm mortar section leader and the antitank section leader are responsible for the discipline, training, and control of their sections, and based on instructions from the platoon leader, for their tactical employment. They make recommendations to the platoon leader on the employment of their sections, general location of firing positions, displacement, and targets. Based on instructions from the platoon leader, they select firing positions for their squads, control fire, and control displacement. They supervise all activities of their sections, including ammunition resupply.

*d. Antitank Squad Personnel.* The discussion of duties contained in paragraph 8g applies, except that the squad leader operates under the direct supervision of the section leader.

*e. 81-mm Mortar Squad Personnel.* The discussion of duties contained in paragraph 8h applies, except that the squad leader operates under the direct supervision of the section leader, and any member of the squad may be designated as light truck driver.

*f. Ammunition Handler.* The ammunition handler of the antitank section headquarters resupplies ammunition to the antitank squads under supervision of the section leader. He is also the light truck driver.

## Section IV. OPERATIONS, GENERAL

### 13. Operational Comparison of Infantry and Airborne Division Rifle Companies

The rifle companies of the infantry division battle group and the airborne division battle group operate tactically in substantially the same manner. Minor differences in organization and equipment require slight modification of the material contained in chapters 2 through 6 in the case of the rifle company, airborne division battle group. Appropriate modification includes the following:

a. The rifle company, airborne division battle group, has more adequate communications with which to control the company than does the rifle company, infantry division battle group. See paragraphs 24 through 27.

b. Differences in organic transportation provide the rifle company, airborne division battle group, more flexible means for transporting ammunition and equipment. Because transportation is organic to lower units, less reliance need be placed on company headquarters for ammunition resupply than in the rifle company, infantry division battle group. See chapter 7. References to the *company ammunition distributing point* apply generally to the *supply control point* of the rifle company, airborne division battle group, within the concepts contained in paragraphs 220 through 222.

c. The antitank section headquarters and the 81-mm mortar section headquarters organic to

the weapons platoon, rifle company, airborne division battle group, facilitate control, ammunition resupply, and supervision of the squads of the platoon. References in chapters 2 through 6 to supervision, control, and the chain of command within the weapons platoon must be modified to include the section leaders. References to ammunition resupply of the antitank and 81-mm mortar squads must be modified to compensate for differences in organization and transportation.

d. During ground combat operations, the weapons platoon leader may utilize the section leaders to assist him in reconnaissance and direct them to make recommendations concerning position areas, targets, routes, displacement, and other matters pertaining to the employment of their sections. The weapons platoon leader issues his orders to his section leaders, who in turn issue their orders to their squad leaders. During the conduct of operations, the antitank section leader locates himself where he can best control the squads of his section. When he cannot control both squads from one location, he may initially locate himself near the squad covering the most dangerous area, moving as necessary to control the other squad. When the section displaces by echelon, the antitank section leader normally accompanies the first squad to displace. The 81-mm mortar section leader normally locates himself at the mortar position, where he controls the action of his section. When the section displaces by echelon, the section leader normally accompanies the first mortar squad(s) to displace.

## **14. Tactical Employment**

*a.* The rifle company normally fights as part of the battle group. For limited periods, the company may operate as a semi-independent or independent force. The company may be detached from the battle group and reattached to other elements of the division for a particular operation.

*b.* When operating as part of the battle group or when attached to another unit, the company operates under the direct control of the battle group commander or the commander of the unit to which it is attached. When the company is operating as an independent or semi-independent force, the company commander normally receives a mission-type order, and he employs the company with little or no control being exercised by the battle group commander during the conduct of the operation.

## **15. General Considerations Under Nuclear Warfare Conditions**

*a.* The rifle company must be trained to accomplish assigned missions in either a nuclear war or in a nonnuclear war in which the threat of nuclear warfare exists. Since the threat of nuclear warfare will be present in nonnuclear war, emphasis must be placed on the company's ability to fight under nuclear warfare conditions.

*b.* Nuclear warfare is characterized by sudden and drastic changes in the tactical situation. Such conditions require flexibility, initiative, strong leadership, and a thorough understanding

of the overall mission by commanders and leaders at all echelons. Opportunities may exist for decisive action, and units must be prepared to act instantly and aggressively to exploit these opportunities while they exist. Use of unit standing operating procedures and contingency planning for situations which can be reasonably foreseen will facilitate operations.

*c.* Nuclear warfare places a tremendous strain on individual morale. To maintain combat effectiveness of personnel, troops must be thoroughly oriented on the effects of nuclear weapons and trained in use of protective measures. Discipline, training, and effective leadership will contribute much to a unit's confidence in its ability to fight and survive under nuclear warfare conditions.

*d.* Emphasis is placed on denying the enemy information of friendly operations, presenting a minimum nuclear target, and making maximum use of measures which afford physical protection from nuclear weapons effects. Protective measures which may be taken by individuals and/or units include dispersion, frequent and rapid movement, use of linear formations, use of camouflage and concealment, operations during periods of low visibility, deception, and use of emplacements, personnel carriers, and individual protective measures to reduce exposure to nuclear weapons effects.

*e.* In general, units remain dispersed to the maximum consistent with the accomplishment of the mission. Factors influencing the degree of dispersion which may be accepted include the



mission, communications, availability of supporting fires, relative mobility, terrain, weather, proximity of enemy forces, and enemy capabilities. When a concentration of forces is necessary, it is accomplished at the last possible moment and as rapidly as possible. Elements are again dispersed as soon as the requirement for concentration no longer exists. While the company disperses its elements as a normal part of operations, the degree of dispersion within rifle platoons is normally limited because of communication restrictions.

*f.* The company standing operating procedure includes those habitual practices which will reduce the vulnerability of the company to nuclear attack and otherwise increase its effectiveness under nuclear warfare conditions. Appropriate items for inclusion in the SOP are the use of monitoring teams to determine radioactivity; warning systems to quickly disseminate information of the use of friendly and enemy nuclear weapons; first aid procedures; reorganization after nuclear attack, including the succession of command; marking of radioactive areas, decontamination procedures; action under fallout; use of cover, concealment, and camouflage; reporting of information; and use of individual protective measures.

*g.* For additional discussion of general considerations of nuclear warfare, see FM 7-40. For a detailed discussion of individual and unit protective measures and associated training, see FM 21-40, FM 21-41, and FM 21-48.

## **16. Security**

a. Security measures must prevent surprise of the unit by enemy action and must provide sufficient time for the unit to take necessary measures to counter the enemy threat. These measures include those steps taken to prevent surprise by enemy ground, airborne and air attack, and to provide early warning of chemical, biological, and radiological attack or contamination. A commander or leader is responsible for the security of his unit at all times, regardless of the measures taken by a higher commander.

b. Specific security measures may include use of observation posts, listening posts, patrols and security detachments, warning devices, surveillance devices, and instruments to detect radioactivity and use of chemical agents. The formation or disposition adopted by a unit contributes to its security. For a discussion of security measures appropriate to CBR warfare, see FM 21-40. Security measures appropriate for various tactical operations are contained within this text.

## **17. Action Against Enemy Aircraft**

The rifle company and its elements utilize passive measures to prevent detection by enemy aircraft and to minimize effects of an air attack. Such measures include dispersion, use of cover, concealment, and camouflage, and establishment of an adequate warning system. In the event of an air attack, all available small-arms fire is delivered on the attacking aircraft. Positively

identified low-flying enemy aircraft may be taken under fire, even though the unit is not under direct attack, when the unit's location is probably known to the enemy.

## **18. CBR Warfare**

For a discussion of individual and unit actions under CBR warfare conditions, see FM 3-5, FM 21-40, and FM 21-41.

## **Section V. INTELLIGENCE**

### **19. General**

*a.* The company commander and subordinate leaders use combat intelligence in developing sound plans of action. The purpose of the intelligence effort is to discover facts concerning the weather, terrain, and enemy to facilitate accomplishment of the mission, and to deny the enemy information of friendly forces and terrain.

*b.* The rifle company is an important information collection agency for higher headquarters. The company may receive specific collection missions. All significant information is reported promptly to battle group and is disseminated to subordinate and adjacent units.

*c.* Intelligence produced by higher headquarters is furnished to the company commander, who, in turn, disseminates it to his subordinates.

*d.* Unit standing operating procedures normally prescribe special measures to expedite reporting of particularly vital information. This

information may include such items as indications of enemy use of nuclear weapons.

*e.* For a more complete discussion of intelligence and intelligence training, see FM 30-5 and FM 30-7.

## **20. Weather**

*a.* The company commander normally receives daily weather forecasts from battle group. Information of the weather is evaluated to determine its effects on tactical operations.

*b.* The times of BMNT (beginning of morning nautical twilight), sunrise, sunset, EENT (end of evening nautical twilight), moonrise, moonset, and the phase of the moon are important in determining visibility. BMNT and EENT are particularly important because these are the times at which visibility is limited to about 400 yards. There is sufficient light for approximately 30 minutes before BMNT and after EENT for troops to move about freely and for leaders to control movement easily. Visibility is affected by such other conditions as cloud cover, fog, rain, snow, dust, and haze. Rain, snow, freezing, or thawing may affect troop movements, particularly by vehicle. Storms may limit the use of helicopters or other aircraft, while severe temperatures may adversely affect personnel and equipment.

## **21. Terrain**

Terrain is one of the major factors considered in the commander's estimate of the situation. The military aspects of terrain described below

are studied to determine how the terrain can best be used to aid in accomplishing the mission.

*a. Observation and Fields of Fire.* Observation is essential to gain information of the enemy, to accurately direct fire on him, and to control friendly troops. Fields of fire are essential for the effective employment of direct fire weapons. The commander considers observation and fields of fire available in his zone or area both from a friendly and enemy point of view.

*b. Cover and Concealment.* Cover is protection from fire; concealment is protection from observation. The commander determines the cover and concealment available to both his company and the enemy. He evaluates cover from the standpoint of different types of fire—flat trajectory, high angle fire, and nuclear bursts. An area such as woods may provide excellent concealment from both air and ground observation, but little or no cover, especially from high explosive shells and nuclear weapons.

*c. Obstacles.* Obstacles are either natural or manmade features which stop, delay, restrict, or divert movement. Natural obstacles include such features as unfordable streams, swamps, very steep slopes, and lakes. Manmade obstacles include obstacles created by nuclear weapons, minefields, barbed wire entanglements, roadblocks, and antitank ditches. The commander considers the effect of obstacles on the movement of foot troops, wheeled vehicles, and tracked vehicles. Obstacles that limit enemy movement into the flank of the company are protective obstacles.

*d. Critical Terrain Features.* Any feature, the seizure or retention of which affords a marked advantage to either combatant, is a critical terrain feature. Examples include such features as a hill, ridge, bridge, defile, built-up area, key buildings within a built-up area, or a railroad embankment in a flat area. Critical terrain features within and adjacent to the unit's zone or area are studied to determine their effect on the operation.

*e. Avenues of Approach.* This is an area of terrain that provides a suitable route of movement to an objective or critical terrain feature for a force of a particular size and type. In the attack, the commander studies his area to determine available avenues of approach to the objective. He also determines which avenues of approach the enemy can use for counterattacks. In the defense, the commander studies his sector to determine avenues of approach available to the enemy leading to critical terrain features within or in rear of his battle area. When analyzing avenues of approach, the commander considers:

- (1) Other military aspects of terrain. An avenue of approach should provide maximum utilization of critical terrain features, observation and fields of fire, cover and concealment, and should avoid obstacles.
- (2) Ease and speed of movement and control, and the size and type of the unit to use the avenue of approach.

- (3) **Cross compartments and corridors.** A terrain compartment is an area bounded on two opposite sides by terrain features that limit ground observation and direct fire into the area. Terrain compartments are classified as corridors or cross compartments, depending on the direction of movement of forces operating in them. A corridor is a terrain compartment whose long axis lies parallel to the direction of movement. A cross compartment is a terrain compartment whose long axis lies across the direction of movement (fig. 3). A corridor generally favors the attacking unit. It provides two types of avenues of approach—a ridge approach and a valley approach. Using the ridge approach insures control of the dominant terrain, provides observation and fields of fire,

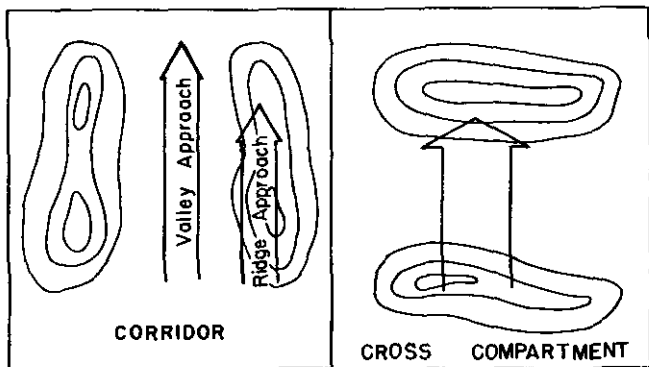

*Figure 3. Terrain compartments.*

and, by moving along the slopes, often permits some cover and concealment to be obtained. The valley approach often provides the best concealment but reduces observation and fields of fire. It is dangerous to use unless measures are taken to insure control of the high ground to the flanks. A cross compartment generally favors the defending force because it affords observation and fields of fire across the entire front.

## **22. Enemy Information**

a. Information is sought of the enemy *strength, location, and activity*. A proper evaluation of this information results in determination of enemy capabilities and their probable order of adoption. Of particular interest at company level and below are such items of enemy information as: strength and location of opposing forces in contact; enemy activity; details of positions, including automatic weapons, tanks, and anti-tank weapons; location and strength of local reserves; minefields, barbed wire, and other obstacles; and similar information.

b. Nuclear warfare conditions stress the importance of collection of enemy information by forward forces. Emphasis is placed on detecting and rapidly reporting profitable nuclear targets so that fires may be delivered before enemy forces disperse. Units are particularly alert to detect any sudden enemy withdrawal, which may be an indication of nuclear attack.



c. The company obtains information of the enemy primarily through patrolling, observation, and use of surveillance means; and from higher headquarters, adjacent units, and supporting units. Since the enemy maintains a counterintelligence effort, the company must be aggressive in its efforts to obtain enemy information. When appropriate, the company commander requests assistance, such as aerial photography, from higher headquarters. Personnel are trained to report all information of the enemy, to include negative as well as positive information. Often information that the enemy is *not* at a certain location or engaged in a certain activity is as important as positive information.

d. Patrolling is normally coordinated by battle group. Even though the battle group patrol plan requires the company to perform certain patrolling missions, this plan does not prevent the company from conducting additional patrolling for its own purposes. The battle group SOP will usually specify coordination required in the use of patrols.

e. Prisoners of war may be interrogated briefly at company level, if an interpreter is available, to obtain information of immediate interest to the company. Such interrogation must not unduly delay the evacuation of prisoners to higher headquarters.

### **23. Counterintelligence**

a. Counterintelligence measures are taken to deny the enemy information of friendly forces,

expose and neutralize his intelligence effort, and to mislead him through deception. In order to be effective, counterintelligence measures must be understood and practiced by all personnel concerned.

b. At company level, emphasis is placed on denying the enemy information and neutralizing his intelligence effort. The company normally does not engage in deception except as directed by higher headquarters. Counterintelligence measures taken at company level and below include secrecy discipline, censorship, communication security, counterreconnaissance, surveillance, and control of civilians. Specifically, the company commander is responsible for insuring that counterintelligence measures directed by higher headquarters are implemented and enforced and that—

- (1) All personnel are instructed on their behavior if captured.
- (2) Letters, personal papers, photographs, and other material that could provide the enemy information are collected from all personnel prior to an action.
- (3) Specific instructions are issued on safeguarding military information and equipment, including the destruction of documents and equipment of value to the enemy if capture is imminent.
- (4) Camouflage, cover, and concealment are properly used and that noise and light discipline are enforced.

- (5) The challenge and password are properly used.
- (6) Bivouacs and assembly areas are policed to insure no personal items, maps, documents, and other material of possible intelligence value are left behind.
- (7) Information on the friendly use of nuclear weapons is disseminated at the latest practicable time.

## **Section VI. COMMUNICATION**

### **24. General**

a. Effective communication is essential to the control of the company and its elements. The company utilizes a combination of radio, telephone, visual, sound, and messenger communications to provide as many multiple means of transmitting messages as conditions will permit.

b. The company commander is responsible for the installation, operation, and maintenance of the company communication system and for its efficient functioning as part of the battle group system. He insures that his subordinates are properly trained and utilized to assist him in the execution of his communication responsibilities. The communication chief is the principal assistant to the company commander in communication matters.

c. Training of those personnel who habitually use the company's communication equipment is mandatory. In addition, as many other personnel

of the company are trained in the operation of radios and telephones and the installation and maintenance of wire lines as conditions will permit. Such training in depth provides additional operator personnel required for sustained operations. Emphasis in training is placed on radio-telephone procedure and communication security.

*d.* Operation orders contain instructions pertaining to communications. These instructions include such items as the location of the commander or the command post, restrictions on use of certain communication means, allotment of available communication facilities, special prearranged visual or sound signals, and pertinent extracts from the SOI of higher headquarters. Throughout the operation, other instructions pertaining to communications are issued as required.

*e.* For additional information on communications, see FM 7-24.

## **25. Use of Communications**

*a.* Effective communication is a result of the joint effort of both units concerned, even though one of these units has primary responsibility for establishing and maintaining communication with the other. In the event of a communication failure, *both* units concerned take immediate action to locate and eliminate the trouble and continue such action until contact is regained. Responsibility for initially establishing communication between the company and other units is as discussed in FM 7-24.

*b.* Radio and messenger are the primary means

of communication used in the offense and in other operations involving rapid and extensive movement. Radio is supplemented by visual and sound signals, and when possible, by wire. Additional radio communication may be made available to the company through the attachment of personnel carriers or when additional radio equipment is furnished for a task force. In the use of radio communication, operator proficiency and discipline are required to keep transmissions as brief as possible. Consistent with instructions from higher headquarters, plans are made for use of alternate radio frequencies and other communications in the event of enemy jamming. For type company radio nets, see paragraphs 26 and 27.

c. Wire and messenger are normally the primary means of communication in defense, supplemented by other means of communication. Two or more wire lines are installed over different routes. Every effort is made to recover wire when its use is no longer required. During withdrawals when wire cannot be recovered, the last using unit removes sections of the wire or otherwise disrupts the wire net to prevent its use by the enemy. Radio is usually used in defense only in the event of wire failure, enemy contact, or when ordered by higher headquarters. For type company wire nets, see paragraphs 26 and 27.

d. Visual signalling is accomplished through the use of organic panel sets, pyrotechnics and smoke of various types and colors, arm and hand signals, flashlights, tracer ammunition, and improvised lights and flags. Instructions from

higher headquarters normally prescribe the use of panel signals for ground-to-air communication and the use of pyrotechnic or smoke signals to call for, shift, or lift fires or illumination. The unit SOP normally prescribes arm and hand signals and flag signals.

e. Sound signals are normally used for alarms and are usually prescribed in the SOP or signal instructions. Such signals may be used to warn of air, CBR or ground attack or the imminent use of nuclear weapons. Whistles, horns, gongs, small arms, or other noisemakers may be used.

f. Foot messengers are used extensively within the company, and their value should not be underestimated. Motor messengers are normally used between the company and battle group.

## **26. Communication in the Rifle Company, Infantry Division Battle Group**

a. *Equipment.* For specific items of communication equipment organic to the rifle company, see current TOE. For capabilities, operation, and maintenance of specific items, see applicable 11-series technical manuals.

b. *Type Radio Net.* Type Radio nets for the rifle company, infantry division battle group, which are appropriate for most situations, are shown in figure 4. Modification of these nets may be required in certain situations. Improvisation may be necessary to furnish radio communications to patrols, security detachments, or other elements.

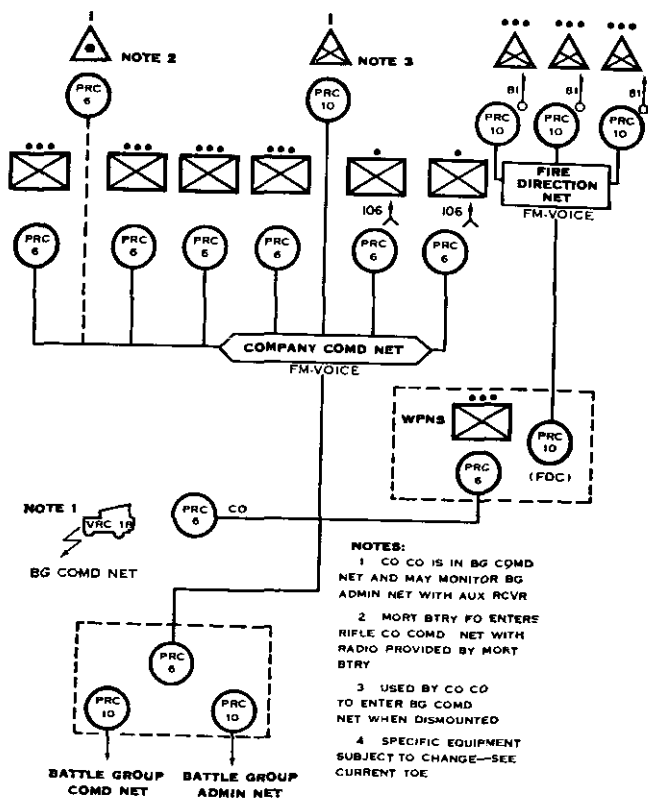

Figure 4. Type radio nets, rifle company, infantry division battle group.

c. *Type Wire Net.* A type wire net for the rifle company, infantry division battle group, which is appropriate for most static situations, is shown in figure 5. Modification of this net may be appropriate to provide telephone communication

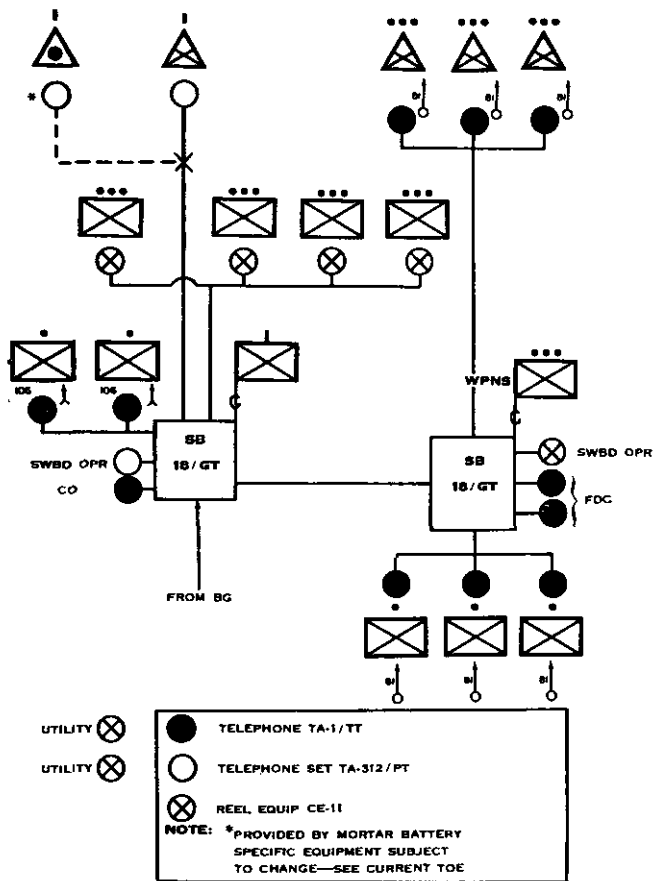

Figure 5. A type wire net, rifle company, infantry division battle group.

with listening posts, attachments, and other elements.



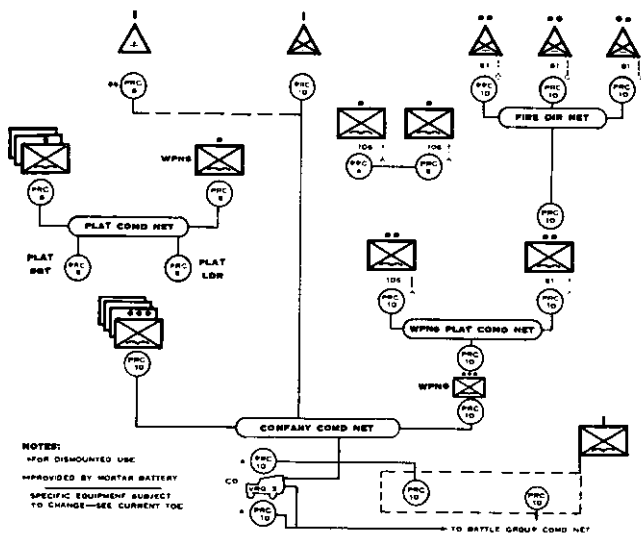

Figure 6. Type radio nets, rifle company, airborne division battle group.

## 27. Communication in the Rifle Company, Airborne Division Battle Group

a. *Equipment.* See paragraph 26a.

b. *Type Radio Net.* Type radio nets for the rifle company, airborne division battle group, which are appropriate for most situations, are shown in figure 6. Modification of these nets may be required in certain situations. Improvisation may be necessary to furnish radio communications to patrols, security detachments, or other elements.

c. *Type Wire Net.* A type wire net for the rifle company, airborne division battle group,

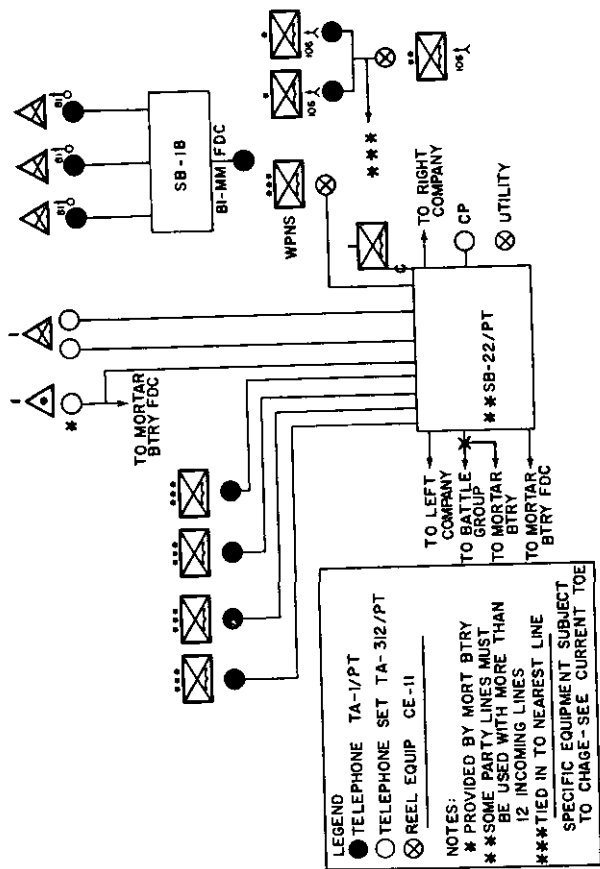

Figure 7. A type wire net, rifle company, airborne division battle group.

which is appropriate for most static situations, is shown in figure 7. Modification of this net may be appropriate to provide telephone communication with listening posts, attachments, and other elements.

## CHAPTER 2

# TACTICAL MOVEMENTS

---

### Section I. INTRODUCTION

#### 28. General

A tactical movement is one made under combat conditions when contact with the enemy is anticipated. The rifle company may participate in such tactical movements as movement to contact, movements away from the enemy; or other movements to relocate troops according to operational plans. During all tactical movements, the company must be prepared against ground or air attack, including CBR attack. The degree of preparedness required will depend on the imminence of enemy action. The likelihood of enemy contact will vary from remote to imminent, depending upon such factors as the distance of friendly forces from the enemy, the relative mobility of opposing forces, and the presence of friendly covering or security forces.

#### 29. Formations

The formation adopted by the company is based on the imminence of enemy contact. When enemy contact is remote, troops are disposed in the

column to facilitate ease of control, rapidity of movement, and other administrative considerations. Adequate dispersion is maintained to provide protection from air attack and long-range artillery fires. As enemy ground contact becomes more probable, elements are grouped tactically in the column to facilitate prompt adoption of combat formations. The tactical grouping of troops within the column is based on the probable future employment of the company. When contact is imminent, troops are grouped tactically and are deployed in anticipation of enemy ground action. Under such conditions, the mission assigned the company may require it to adopt a formation as advance guard, flank guard, or rear guard.

### **30. Security**

Depending on the terrain and the imminence of contact, security measures during movement may vary from observation to the use of security patrols. During short halts, sentinels, small security detachments, and/or patrols are used to provide all-round security. During longer halts, additional measures taken may include disposition of elements of the company to permit all-round defense. See paragraph 16.

### **31. Control**

a. Positive control of the company depends primarily upon sound planning and adequate communication. All applicable communication facilities, consistent with security considerations,

are used to assist in maintaining control. During movement, the principal means of communication are radio and messenger which are supplemented by visual signals.

b. March objectives, check points, and phase lines may be used to assist the commander in controlling his unit. Unless otherwise specified, commanders report the arrival of their unit at these locations and continue the march without a halt. For a more detailed discussion of these and other control measures, see FM 25-10 and FM 7-40.

### **32. Security Missions**

The company may be assigned a mission of providing security for the main body. Security missions which may be assigned include advance guard, flank guard, and rear guard. While performing a security mission, the company may be required to attack, defend, or delay in order to accomplish its mission, regardless of the type of operation being conducted by the main body (protected force). See paragraphs 34 through 42.

### **33. Night Movement**

a. Night movement provides increased concealment, aids in maintaining secrecy, and may permit surprise to be achieved. Difficulty of control at night dictates more detailed planning and the use of more stringent control measures. Rates of movement are generally less at night than during daylight. Formations used are similar to those used during a daylight movement; however,

difficulty of control will often require that distances between individuals and units be less.

*b.* Measures taken for control at night may include the posting of guides, marking of routes, marking of individuals for ease of identification, increased use of connecting files, use of infrared equipment for signaling, and the more frequent reporting of location by subordinate leaders.

*c.* Emphasis is placed on the maintenance of secrecy by rigid enforcement of noise and light discipline.

## **Section II. TACTICAL FOOT MARCHES**

### **34. Rifle Company as Advance Guard—Mission and Organization**

*a.* The mission of the rifle company as advance guard is to prevent unnecessary delay in movement of the main body and to protect it from surprise attack from the front. The advance guard serves to deny the enemy ground observation of the main body from the front and to cover the deployment of the main body if necessary.

*b.* Motorized or mechanized security elements, such as a reconnaissance unit, may precede the advance guard company initially. The advance guard company may be reinforced with tanks, engineers, aircraft, or other elements to facilitate the accomplishment of its mission.

*c.* From front to rear, the advance guard company is organized into the point, the advance party, and the advance guard minus (fig. 8).

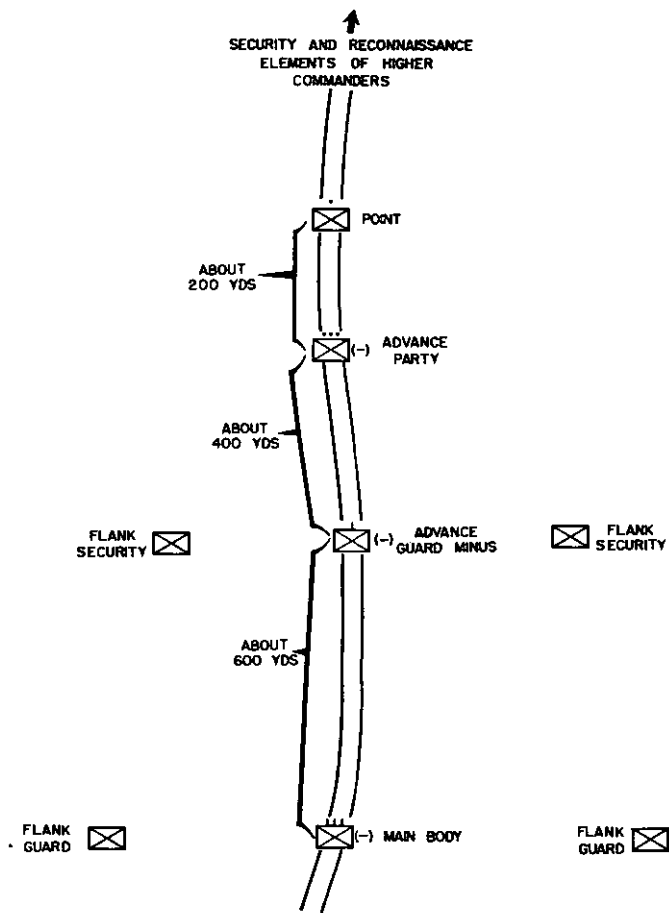

*Figure 8. A type formation for the battle group in an advance to contact.*



The commander of the advance guard company sends forward a platoon which comprises the advance party. The advance party commander sends forward one rifle squad to serve as the point. The rifle company, less the advance party, is known as the advance guard minus. Distances between elements of the company as indicated in figure 8 are guide figures only and will vary according to the situation, terrain, and visibility. These distances are prescribed initially by the commander of the advance guard and should be great enough to allow each succeeding element to deploy without serious interference from the enemy once contact is made. However, the distances are not so great as to prevent each element from rapidly assisting the element in front of it.

### **35. Advance Guard Formations**

*a. Advance Guard Minus.* The advance guard minus normally moves in a column formation, with elements arranged in order of anticipated use.

- (1) Tanks will frequently be attached to the advance guard, though seldom will more than a platoon be attached in a dismounted movement to contact. Normally a section of tanks moves with the advance party, and the remaining tanks move with the advance guard minus. Such utilization provides additional support for the advance party, while some tanks are available for commitment with the advance guard minus, if necessary.

Tanks normally move by bounds, based on the recommendations of the tank unit leader.

- (2) Engineers normally move with the advance guard minus. Engineer reconnaissance personnel may move with the advance party when the timely accomplishment of their mission requires them to be well forward in the column.
- (3) The 81-mm mortar squads normally move on carrier near the head of the advance guard minus, prepared to occupy firing positions quickly when necessary. Conditions may warrant keeping one mortar in position to provide immediate fire support and leapfrogging remaining mortar squads forward as the advance continues. A mortar forward observer usually accompanies the advance party. The antitank squads are normally placed within the column so as to be able to provide antitank protection for the advance guard minus.
- (4) The company commander usually marches at or near the head of the advance guard minus, though he moves wherever he can best influence the action. He may be accompanied by the weapons platoon leader, the artillery forward observer, an 81-mm mortar forward observer, and such leaders of attached or supported units as he may specify.

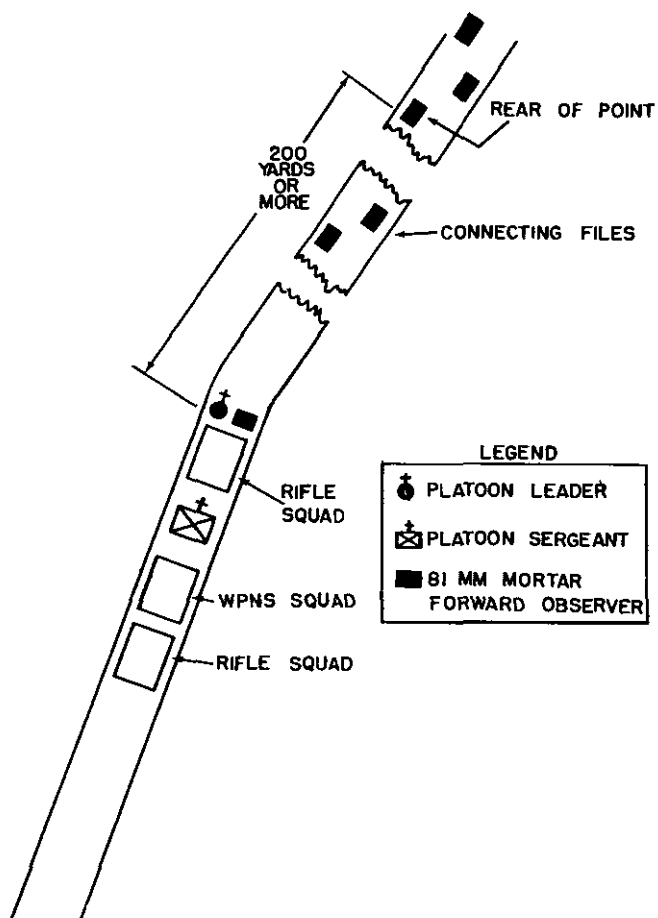

Figure 9. A type formation for the advance party.

- (5) Physical contact between the advance guard minus and the advance party is maintained by connecting files sent forward from the advance guard minus.

*b. Advance Party.* The advance party normally moves in a platoon column formation (fig. 9). The order of march is based upon anticipated future employment. A CBR detection team may accompany the advance party, moving near the head. When an engineer reconnaissance team accompanies, it normally moves at the rear of the advance party. The platoon leader moves wherever his presence is required. Connecting files from the advance party maintain physical contact with the point.

*c. Point.* Along a road, the point moves in a squad column with approximately ten paces between men. The distance between the leading 2 or 3 men may be increased to approximately 20 paces. The squad leader positions himself where he can best control his squad (app. V). The point squad leader is normally furnished a radio.

### **36. Conduct of the Advance Guard**

*a.* Elements of the advance guard take maximum advantage of available cover and concealment, consistent with the prescribed rate of march. If the advance is along a road, for example, movement may be made along either side of the road to achieve maximum concealment from enemy ground and air observation. Care is taken that no enemy elements are bypassed by such action.

*b.* Information of the enemy and terrain received from higher headquarters is immediately disseminated to elements of the advance guard. Similarly, such information obtained by elements of the advance guard is reported to the company commander, who in turn informs the battle group commander. Timely and accurate reporting is essential to permit commanders at all echelons to formulate effective plans for the employment of their units.

*c.* The point normally does not deploy elements to the flanks but relies on observation for security. The advance party also normally relies on observation for security but may utilize small, close-in flank security elements when necessary. The company commander specifies the measures taken to provide flank security for the advance guard minus. Normally foot detachments from the advance guard minus operate on the flanks and abreast of the advance party, maintaining contact by connecting files. Motorized or mechanized security detachments from the advance guard minus are used when possible to block likely enemy approaches until the advance guard has passed. The size of these detachments may vary from a half squad to a reinforced squad. For additional discussion of security, see paragraphs 16 and 30.

*d.* Advance guard actions are characterized by aggressiveness. Unless otherwise ordered, elements of the company attack without hesitation to drive off the enemy. Upon encountering enemy resistance, the point returns fire immedi-

ately, deploys, and attacks. The advance party commander moves forward, makes a reconnaissance and an estimate of the situation, and determines where best to commit the advance party if such is warranted by the situation. If the point has been unsuccessful in reducing the enemy resistance, the advance party commander attacks with the entire advance party. All available firepower is utilized; supporting weapons are moved forward to firing positions. Every effort is made to attack by a quick flanking maneuver rather than a frontal attack. The company commander moves forward for his reconnaissance and estimate of the situation. When the situation warrants, he commits the entire advance guard to strike the enemy by maneuver against his flank or rear. If the advance guard is unable to reduce the enemy resistance, it immobilizes him by fire and locates his flanks to provide the battle group commander with information upon which to base his plan of attack. For additional discussion of offensive techniques, see chapter 3. When the enemy withdraws or is destroyed, the advance is promptly resumed.

### **37. Rifle Company as Part of the Main Body**

The rifle company moving as part of the main body normally moves in column formation with approximately two paces between individuals. The leading company maintains the rate of march prescribed by the battle group commander; other companies maintain their position in the column. The company may be ordered to furnish flank

security for the main body. Crew-served weapons which are not employed on security missions generally move on carrier. The company commanders of the companies comprising the main body usually move at or near the head of their respective units. The battle group commander keeps them informed of the situation to the front and flanks to permit timely planning should their units be committed.

### **38. Rifle Company as Flank Guard of a Larger Force**

a. The mission of a flank guard company is to protect the main body from hostile ground observation and surprise ground attack from the flank. In the event of an attack from the flank, this mission requires action that prevents delay of the main body in passing from the area or gives the main body time to deploy and maneuver.

b. The flank guard company may be reinforced by tanks and engineers. Special material such as antitank mines, demolitions, and special means for constructing obstacles may be made available to the flank guard company.

c. The responsibility assigned to a flank guard company may be designated as a series of terrain features blocking likely enemy approaches into the flank of the main body, or may be designated as the flank of a specified unit. When assigned to guard the flank of a unit (usually the battle group) moving in column and unless otherwise specified, the flank guard company's responsibility begins at the rear of the leading subelement of

the protected unit (i.e., leading company in the column) and extends to the rear of the protected unit. When the size of the area of responsibility and the number of approaches prohibit the effective blocking of all approaches, the flank guard company blocks the most critical areas and screens the remainder of the area. (Screening implies providing warning without having the capability to stop or effectively delay a strong enemy force.) The main body commander must be informed of this action.

*d.* The distance of the flank guard from the main body will be sufficient to insure accomplishment of the assigned mission. Normally, the flank guard company will operate within range of the mortar battery of the battle group.

*e.* The formation used by a flank guard is designed to meet enemy threats at any point on the protected flank. When the area of responsibility is extensive and platoons are widely separated, 81-mm mortar squads, tanks, antitank squads, and/or other elements may be attached to platoons to provide them additional support. When the company is less widely deployed, these weapons may be kept centrally located under company control ready to fire or move to meet enemy threats wherever they occur. During movement, the leading platoon (frequently reinforced) of the flank guard organizes and conducts itself as does the advance party of an advance guard.

*f.* The selection of blocking positions for the flank guard is coordinated by the flank guard



company commander with the protected unit commander (usually the battle group commander). These blocking positions are on or near the route of the flank guard and are astride likely enemy avenues of approach. They are occupied on order or when enemy action forces their occupation. The blocking positions may be occupied by a platoon or the entire flank guard depending on the criticality of the approach and enemy action.

*g.* Movement of the flank guard is based upon movement of the protected unit. Successive blocking positions are occupied on order or as required. When possible, the flank guard advances to successive blocking positions by leapfrogging its elements. It maintains close liaison with the protected unit by radio and with patrols (normally motorized). Upon halting of the main body, the flank guard occupies blocking positions which best protect the flank.

*h.* Army aircraft are used frequently to maintain flank surveillance and assist the flank guard by reporting information of the enemy and the terrain to the front and flank. Reconnaissance elements may operate to the front or flank of the flank guard company.

*i.* The nature of a flank guard mission makes its effective accomplishment by a dismounted force extremely difficult. Because of the requirement for rapid movement, a flank guard company may be motorized, mechanized, or provided with helicopter transportation.

### **39. The Company as a Rear Guard**

The rifle company may be assigned the mission of rear guard of a larger force. The rear guard prevents enemy interference with the main body by stopping or delaying enemy forces attacking the rear and by preventing enemy direct fire and ground observed indirect fire from harassing the main body. The organization of the rear guard is similar to the advance guard except that it is oriented toward the rear. Enemy action may force the rear guard to deploy in width so that effective defensive or delaying actions may be conducted. For a discussion of delaying action, see chapter 5.

## **Section III. TACTICAL MOTOR OR MECHANIZED MOVEMENTS**

### **40. Rifle Company as Motorized or Mechanized Advance Guard**

*a.* The reinforced rifle company as a motorized or mechanized advance guard may be preceded initially by reconnaissance elements of a higher unit. The advance guard follows these reconnaissance elements at sufficient distance to allow it to deploy when enemy resistance warrants. The advance guard commander maintains contact with these reconnaissance elements by radio or by motorized or mechanized patrols.

*b.* The organization for the company as a motorized or mechanized advance guard is gen-

erally the same as that of an advance guard conducting a foot movement. The company commander sends out an advance party, which precedes the advance guard minus by a sufficient time interval to permit deployment of the advance guard minus without serious interference from the enemy once the advance party gains contact. This time interval (approximately 5 minutes) will vary depending on the enemy and the terrain and should not be so great as to prevent the advance guard minus from assisting the advance party if necessary.

*c.* The advance party may or may not send out a point, depending primarily on the enemy resistance anticipated and the availability of vehicles for this purpose. If a point is established, the use of two or more vehicles is desirable to permit movement by bounds. The point precedes the advance party by approximately two minutes. This time interval will vary as described in *b* above. The point should be provided with a radio.

*d.* Tanks are normally attached to the company for a motorized or mechanized advance guard operation. A section of tanks may be attached to the advance party; or a tank platoon, adequately reinforced with infantry, may be designated as the advance party. Because of their armor protection and firepower, tanks of the advance party normally lead, though they are seldom separated from the advance party to act as point. Tanks and infantry must be positioned within the formation so as to permit close mutual support between one another.

*e.* Other elements, including fire support elements, are positioned in the formation generally the same as for a dismounted advance guard operation. Distance between vehicles within the advance guard minus is prescribed by the company commander and will depend on the visibility, the terrain, and enemy capabilities. Forward observers normally accompany the advance party and the company commander to facilitate calling for and adjustment of fire.

*f.* The point (if used) and advance party normally do not deploy elements to the flanks but rely on observation and reconnaissance by fire for security. Motorized patrols from the advance guard minus are normally used to provide flank security for the advance guard minus. Air guards are posted in all vehicles. See paragraphs 30 and 36c.

*g.* While rapidity of movement is desirable, security considerations cannot be disregarded. Maximum security of movement is obtained when lead elements move by bounds rather than by continuous movement. When friendly reconnaissance elements are not operating to the front, reconnaissance by fire may be used to provide additional security.

*h.* When enemy resistance is encountered, the actions of elements of the advance guard are similar to those described for a dismounted operation (par. 36d). Close coordination and control are required to insure that elements of the column do not close on one another. When the column halts pending development of the situation to the

front, vehicles are moved off the road to nearby concealment. For additional discussion of offensive techniques, infantry-tank team operations, and mechanized operations, see chapter 3.

#### **41. Rifle Company as Motorized or Mechanized Flank Guard**

a. The discussion of a dismounted flank guard company in paragraph 38 is applicable to a mounted flank guard also. However, a motorized or mechanized flank guard, because of its ability to rapidly move elements to a critical locality, has greater flexibility than a dismounted flank guard and thus may be assigned a larger area to cover. When assigned a large area, the flank guard company blocks the most critical approaches and screens areas containing less critical approaches (par. 38c). Should a sizable enemy threat develop in an area being screened, elements of the flank guard are shifted to the critical area as required.

b. When the area of responsibility assigned to a motorized or mechanized flank guard company is large, considerable separation of platoons may result. To permit their semi-independent operation, rifle platoons are often reinforced with mortars, antitank squads, tanks, and other attachments to provide them with adequate direct and indirect fire support and antitank protection.

c. When the rate of movement of the main body will permit, the platoons of the flank guard occupy a series of blocking positions as described

in paragraph 38. As the main body advances, the rearmost platoon leapfrogs to occupy the next blocking position. Such action provides strong flank security, since most elements of the flank guard company are in position at all times. When the movement of the main body is rapid, continuous movement of the flank guard may be required. The distance between platoons of the flank guard is based primarily on the area of responsibility, enemy threats on the flank, and the location of critical areas along the route. Elements of the flank guard are prepared to occupy positions immediately to counter enemy action from the flank. When the main body halts, elements of the flank guard occupy blocking positions which will provide the greatest flank protection to the main body. Areas between occupied blocking positions are screened as necessary.

*d.* The company commander designates specific responsibility for maintaining physical contact with the main body, for reconnoitering the area between the main body and the flank guard, and for flank security of the flank guard itself. These tasks may be assigned to platoons or may be accomplished by mounted detachments operating directly under company control.

## **42. Motorized or Mechanized Detachments**

The company or some of its elements may act as motorized or mechanized detachments to accomplish reconnaissance, security, and combat missions. When employed in this manner, these detachments may supplement units such as the

**battle group reconnaissance platoon and the division cavalry squadron. For a discussion of appropriate techniques, see FM 7-21 and FM 17-1.**

# CHAPTER 3

## OFFENSE

---

### Section I. GENERAL

#### 43. Mission

The mission of the infantry in offensive action is to close with and destroy or capture the enemy. Since the rifle company, because of its size and organization, possesses limited tactical and administrative capabilities for independent operations, it most often attacks as a part of a coordinated battle group action.

#### 44. Concept of Offensive Operations

a. Rifle elements, moving under the protection of supporting fires or exploiting the effects of these fires, maneuver to a position from which they can assault the enemy and complete his destruction by close combat. The effects of enemy fires are reduced primarily through surprise, rapidity of movement, dispersion, and use of supporting fires.

b. The company may attack *with* or *without* the support of tactical nuclear weapons. Offensive operations under nuclear conditions are characterized by:



- (1) Frequent and rapid movement.
- (2) Deeper objectives.
- (3) Greater reliance on fragmentary and mission type orders.
- (4) Bypassing of enemy resistance and areas which have been engaged by friendly or enemy nuclear weapons.
- (5) Increased distances between adjacent units.
- (6) More attacks from column formations.
- (7) Frequent night operations.
- (8) Infrequent occupation of assembly areas and attack positions.
- (9) Greater dispersion within units.
- (10) More frequent utilization of an axis of advance.

#### **45. Employment of the Rifle Company**

Offensive action is initiated when the battle group commander assigns an offensive mission to the company and designates attached or supporting units. The mission of an attacking rifle company is usually expressed in terms of terrain objectives to be seized. The battle group commander assigns the company either a zone of action, an axis of advance, a direction of attack, or a combination of these measures. The company may be all or part of the main or secondary attack of the battle group, or it may be all or part of the battle group reserve. The company may have foot mobility, or it may be motorized, mechanized, or transported in helicopters. For a discussion of offensive maneuvers in which the com-

pany may participate as part of the battle group, see FM 7-40.

## **Section II. PREPARATION FOR THE ATTACK**

### **46. Actions of the Company Commander**

a. The company commander normally receives a battle group warning order which permits early planning and the initiation of preparations for the attack. The warning order is usually fragmentary and may contain such information as the time of the attack, mission, preliminary plan for employment of elements of the battle group, information pertaining to issuance of the battle group attack order, and administrative instructions necessary for proper preparation. The company commander in turn issues an appropriate warning order to his subordinates.

b. Based on the contents of the warning order, the company commander decides what personnel will accompany him when he goes to receive the battle group order. He normally takes with him the weapons platoon leader, artillery forward observer, leaders or representatives of attached or supporting units, communication chief, a radio-telephone operator, and a messenger. This selection, in addition to other considerations, provides that another officer of the company will be present when the battle group order is issued and that appropriate leaders or their representatives will be immediately available to the company com-

mander after receipt of the order to assist him in formulating his plan of attack.

c. The company commander formulates his plan of attack based on the battle group order, his reconnaissance, recommendations of organic, attached, and supporting unit leaders or their representatives, and his estimate of the situation. In making his estimate of the situation, he considers primarily the *mission, enemy, terrain and weather, and troops and fire support available (METT)*. For a detailed discussion of the estimate of the situation, see appendix II.

d. Essentially, the plan of attack consists of a plan of maneuver and a fire support plan. These are made concurrently, since they are interrelated. In developing his plan of attack, the company commander keeps in mind the accomplishment of his mission in the shortest possible time and with the fewest casualties. He strives to develop a plan which is simple yet complete, provides for flexibility, will achieve surprise, directs the major effort against the principal objective, and minimizes the vulnerability of the company to nuclear and nonnuclear fires and to CBR attack.

e. For a discussion of the actions of the company commander in formulating his plan, issuing his order, and supervising the preparation of the company for action, see appendix III.

#### **47. Assembly Area**

Prior to the attack, the company may occupy an assembly area, the location of which is nor-

mally designated by the battle group commander. In the assembly area, elements of the company are dispersed to the maximum extent practicable to reduce vulnerability to nuclear attack. Every advantage is taken of available cover and concealment, and maximum use is made of camouflage. Elements of the company are disposed to permit all-round defense if required. Individual shelters are dug. Security is posted to prevent surprise by enemy ground or air action. Antitank weapons are positioned to provide protection against surprise enemy armor attack.

#### 48. Preparation of the Company for the Attack

If an assembly area is occupied, necessary preparations for the attack are completed to the fullest extent possible while there. These preparations include conducting of reconnaissance, formulation of plans, and issuance of orders. The following additional specific activities take place:

- a. Ammunition is drawn and distributed.
- b. Weapons, equipment, and personnel are checked for readiness.
- c. Equipment not needed for the attack is collected and stacked for later pickup.
- d. Extra or special equipment needed for the operation is issued.
- e. Troops are rested to the maximum possible extent consistent with providing adequate security, being briefed, and preparing for the attack.
- f. Maps or map substitutes are prepared and issued to subordinate leaders including, at a minimum, platoon and attached unit leaders.

*g.* Organic vehicles join their respective units as required.

*h.* Units attached to the rifle company may join the company in the assembly area.

### **Section III. PLAN OF MANEUVER**

#### **49. General**

*a.* The plan of maneuver is the plan for the employment of the maneuver elements to accomplish the mission. The maneuver elements are the rifle platoons, attached tank platoons, and other attachments which seize or assist in seizure of objectives through movement. Included in the plan of maneuver are the following: control measures; formations; specific missions of maneuver elements, including the reserve; plan for security; plan for reorganization, consolidation, and dispersal; and plan for continuation of the attack.

*b.* The company plan of maneuver may be designed to exploit the effects of nuclear weapons employed by a higher commander.

*c.* The discussion of the plan of maneuver contained in this section pertains primarily to a dismounted daylight attack; however, it is generally appropriate for all types of attack, with minor modification and amplification. For special considerations involved in formulating the plan of maneuver for other types of attack, see applicable sections of this chapter.

## 50. Control Measures

The company commander controls the maneuver elements in the attack by utilizing the control measures listed below, as appropriate. In order to permit his subordinates maximum freedom of action, he prescribes the minimum control measures necessary to insure the progress of the attack in the desired manner.

*a. Time of Attack.* This is usually prescribed in the battle group order. It is the time when the leading element of the attacking companies must cross the line of departure. In conjunction with the line of departure, the time of attack assures the commander that his attacking elements and fire support units are coordinated at the beginning of the attack.

*b. Attack Position.* This is normally the last covered and concealed position short of the line of departure which is occupied by elements of the company for the purpose of effecting final coordination, deploying into the initial attack formation, or making other last-minute preparations prior to the attack.

- (1) The attack position may or may not be used. It is used only when final preparations cannot be completed in the assembly area or on the move, since any unnecessary halt in an attack position needlessly exposes the unit to enemy fires and may reduce the degree of surprise which can be achieved. The use of an attack position is particularly undesirable when a passage of lines is

to be effected because of the nuclear target which is presented in the vicinity of the line of departure.

- (2) When used, the attack position is normally selected by the company commander, except when close control by the battle group commander is required, as in a night attack or attack of a river line. Desirable characteristics of an attack position include: cover and concealment from enemy direct fire and observation; easily recognizable on the ground; and large enough to accommodate the company, adequately dispersed, in the initial attack formation.
- (3) If an attack position is used, it should be occupied for the minimum time necessary.

c. *Line of Departure (LD).*

- (1) The battle group order designates an LD which troops cross at a prescribed time to coordinate the start of the attack. Desirably, it should be easily recognizable on the ground, approximately perpendicular to the direction of attack, under control of friendly units, and not under direct fire or enemy observation.
- (2) In some instances, the LD specified by the battle group commander may be unsuitable for use by elements of the company. When this occurs, the company commander may select an LD in the im-

mediate vicinity of the prescribed LD; however, the prescribed LD must be crossed at the time specified in the battle group order. The time of attack specified in the battle group order applies for purposes of coordinating fires.

- (3) If the LD is the line held by another unit already in contact with the enemy, coordination is required to insure the uninterrupted passage of lines in order to minimize the time that a remunerative nuclear target is presented. Speed and secrecy are emphasized. When possible, plans are made for the attacking elements to be guided through gaps between elements in contact.

*d. Zone of Action.* This is a tactical subdivision of a larger area, the responsibility for which is assigned to a unit for control purposes in offensive operations. The unit assigned the zone is free to maneuver and fire to accomplish its mission within the assigned area. The clearing of enemy resistance within a zone is not required unless specifically directed. When there is no requirement for clearing a zone, a unit may bypass enemy resistance encountered which will not jeopardize the accomplishment of its mission, provided such action is promptly reported to the next higher commander. Zones of action are frequently used for control in dismounted attacks.

- (1) The company zone is normally designated by an LD, a final objective, and boundaries on one or both flanks. If



one flank of the company is exposed, a boundary on that flank is not normally designated. In this case, the company commander determines the width of his zone by analyzing the mission, mobility of the company, presence of reconnaissance elements on the flank, and the ability of elements of the company to maneuver in the area without risk of defeat in detail.

- (2) A platoon zone of action should include at least one adequate approach for the platoon to its objective. In selecting boundaries between platoons, the company commander avoids dividing avenues of approach or critical terrain between two platoons. Platoon boundaries are normally designated on the ground in terms of easily recognizable terrain features. If platoon zones of action are prescribed and an overlay is issued in conjunction with the attack order, boundaries are shown on the overlay.
- (3) When a platoon desires to maneuver or fire in the zone of an adjacent platoon of the company, coordination with the adjacent platoon and notification of the company commander are required. When it is desired to maneuver or fire in the zone of an adjacent company, the company commander must coordinate such action with the adjacent company

commander and notify the battle group commander.

*e. Axis of Advance.* This is a line of advance extending in the direction of the enemy that indicates the *general* direction along which attacking elements will move. It is most frequently used as a control measure in fluid or mechanized operations. A unit moving on an axis may bypass enemy forces which cannot threaten the accomplishment of its mission provided the next higher commander is promptly informed of this bypassing. Similarly, obstacles may be bypassed. The axis of advance is represented on a map or overlay by an arrow labeled "Axis of Advance" starting at the line of departure and continuing to the objective.

*f. Direction of Attack.* A direction of attack is a *specific* direction in which a unit directs its attack. The terrain along the direction of attack must be cleared of effective enemy resistance. Because of its restrictive nature, the direction of attack is normally used only when a commander must maintain close control over the maneuver of subordinate elements to accomplish a closely coordinated plan of maneuver. It is often used to designate the direction of a counterattack. A direction of attack is represented graphically by an unlabeled arrow.

*g. Check Points.* This is an easily identifiable point on the terrain used either to control movement or as a reference point for reporting locations of friendly units. It may be used "in the clear" to report locations of units or to designate

targets for supporting weapons. The company commander may designate as check points those terrain features to which rapid reference may be required during the conduct of the attack. For simplicity, the number of check points selected is held to a minimum consistent with anticipated needs. A check point is represented graphically by a circle in which appears the check point number.

*h. Contact Points.* This is a point on the terrain where two or more units are required to make physical contact. Contact points are seldom designated by the company commander for use during the attack, except as required after seizure of the objective when platoons have dispersed. A contact point is represented graphically by a square in which appears the number of the contact point.

*i. Phase Line.* A phase line extends completely across the zone or likely area of action. It is located on an easily recognizable terrain feature such as a ridge line, stream, or road. It is used to control the forward movement of units. Units report arrival at (and sometimes clearance of) phase lines, but do not halt unless so ordered. A phase line may be used to limit the advance of attacking elements.

*j. Assault Line.* This is a line on the ground at which the assault echelon completes its deployment and from which an assault is launched. It is located as close to enemy positions on the objective as attacking troops can move before becoming dangerously exposed to friendly support-

ing fires. When enemy positions are known and supporting fires can be carefully planned in advance, the company commander may tentatively select an assault line while planning the attack. This line should be easily recognizable on the ground. Often an assault line cannot be selected prior to the attack. See paragraph 61 for a discussion of selecting or changing an assault line during the attack. The company commander normally selects tentative assault lines only for those objectives on which a coordinated assault of two or more platoons is planned, leaving the selection of other assault lines to the platoon leaders.

*k. Objectives.* Assigned objectives must be seized and controlled, but need not necessarily be cleared of all enemy resistance. Based upon his estimate of the situation (app. II), the company commander may subdivide the company objective(s) into platoon objectives and, in addition, assign such intermediate platoon objectives as are necessary.

- (1) Terrain features selected as objectives may be—
  - (a) Terrain which dominates all or the major portion of the company zone or axis of advance and which, if occupied by the enemy, would jeopardize the accomplishment of the mission.
  - (b) Terrain on which difficult combat is anticipated, indicating a need for a period of reorganization.

- (c) Terrain from which a coordinated attack will be launched, or other terrain required for purposes of control, as in areas where observation is limited or where distances involved require displacement of supporting weapons.
- (2) Terrain features selected as platoon objectives should have as many of the following desirable characteristics as possible:
  - (a) Easily recognizable on the ground.
  - (b) Provide for convergence of effort.
  - (c) Within effective range of the company 81-mm mortars.
  - (d) Width and depth not greater than can be seized in a single assault. Normally a platoon objective is no more than 300 yards wide.
- (3) The number of objectives selected should be the minimum required to maintain control, coordination, and the progress of the attack in the manner desired by the commander.

## **51. Specific Missions to Platoons**

Each maneuver element is given a specific mission prescribing its role in the plan of maneuver. Missions assigned to attacking platoons are usually in terms of terrain objectives to be seized. The company commander gives his platoon leaders maximum freedom of action consistent with his overall plan. For appropriate missions for

the reserve platoon(s), see paragraph 53. For appropriate missions for attached tanks, see paragraphs 75 through 81.

## **52. Formation**

a. In formulating his plan of maneuver, the company commander determines how many rifle platoons he will use in the attack echelon and how many he will hold in reserve. The initial attack formation is the initial disposition of the rifle platoons as they cross the LD. The initial attack formation is changed, as required, during the conduct of the attack.

b. For a rifle company, there are four basic attack formations:

- (1) One platoon in attack; three platoons in reserve.
- (2) Two platoons in attack; two platoons in reserve.
- (3) Three platoons in attack; one platoon in reserve.
- (4) Four platoons in the attack.

c. In determining the formation(s) for the attack, the company commander considers the *mission, enemy, terrain and weather*, and *troops and fire support available* (METT). The company commander plans to commit only as many platoons to the attack echelon as are necessary to accomplish the mission. While there are no fixed sets of conditions which will determine the most appropriate formation for a given situation, the following discussion may serve as a guide:

- (1) A formation of 1 platoon in the attack and 3 platoons in reserve provides limited firepower to the front but a very strong reserve. This formation may be appropriate when information of the enemy is vague or when the company has one or both flanks exposed, indicating the need for a very strong reserve; when only a single, narrow avenue of approach is available and/or when attacking to seize a deep objective (as in mechanized operations).
- (2) A formation of 2 platoons in the attack and 2 platoons in reserve provides considerable firepower to the front and a strong reserve. This formation may be appropriate when available information of the enemy indicates a need for more than 1 platoon in the attack but is comparatively vague, also indicating a need for a strong reserve; and/or when a strong reserve is desired for rapid continuation of the attack after seizure of an initial objective.
- (3) A formation of 3 platoons in the attack and 1 platoon in reserve provides the maximum firepower to the front consistent with retaining a reserve large enough to influence the action. This formation may be appropriate when relatively detailed information of the enemy is available; when the need for a large reserve does not exist; and/or

when it is desired to seize and clear a relatively wide area rapidly.

- (4) A formation of four platoons in the attack provides maximum fire power to the front, but provides no reserve with which to influence the action. This formation may be appropriate when a wide area must be cleared rapidly; or in instances when the use of a reserve is limited, as in a night attack or attack of a river line.

### **53. Plan for Use of Reserve**

a. The reserve is the portion of the rifle company withheld from action at the beginning of the engagement, and available for employment at the decisive moment. The main purpose of the reserve is to have a unit capable of being employed to insure the success of the attack or to maintain momentum. The reserve may be ordered to accomplish, or be prepared to accomplish, specific missions. Appropriate missions for the reserve may include one or more of the following:

- (1) *Protect one or both flanks of the company.* Normally this is accomplished through the use of flank combat patrols. The company commander usually prescribes the size of these patrols, and he may control their movement. The entire reserve may be echeloned within the formation; its location protects the exposed flank.



- (2) *Maintain connecting group contact with adjacent units.* The size and actions of connecting groups are normally prescribed by the company commander. Control may be exercised by either the company commander or the reserve platoon leader.
- (3) *Assist the assault echelon by the fire of the machinegun teams of the weapons squad.* The machineguns may be placed in position along the LD to support the attack by firing at enemy positions located on the objective or along the route of the assault echelon. Such employment should not restrict the use of the guns by the reserve platoon when subsequently employed.
- (4) *Attack from a new direction any enemy holding up the progress of the attacking echelon.* As one of the means available to influence the action, the reserve is committed without hesitation to effect a decision. The company commander strives to maneuver his reserve against the enemy flank or rear. He further strives to maintain the momentum of the attack by committing the reserve when there are indications that the attack is about to slow down.
- (5) *Assume the mission of the attacking platoon(s).* If the attacking echelon, or a portion of it, has become disorganized or ineffective because of heavy casual-

ties, the reserve may be employed to replace such elements. The commander should commit it in a new direction rather than through the disorganized element.

- (6) *Mop up a position* which has been overrun or bypassed by the attack echelon.
- (7) *Protect the reorganization and consolidation* of the attack echelon. The reserve may be employed in whole or in part to protect a flank, to complete a company perimeter, to install protective minefields, or to outpost or patrol to the front and flanks of the attacking echelon during reorganization and consolidation.

b. The reserve is positioned where it can best perform its assigned mission(s). The company commander prescribes the initial location(s) of the reserve. This location(s) is often in a covered and concealed area a short distance in rear of the LD, but the assignment of certain missions to the reserve may dictate otherwise. The reserve usually displaces from one easily recognizable terrain feature to another on order of the company commander. He plans subsequent locations to keep the reserve sufficiently forward to be available immediately to influence the action, yet far enough to the rear to stay out of the same fire fight as the attacking platoons. The company commander may displace all or part of it in the zone of the rifle platoon expected to make the best progress. All or part of it may be echeloned toward an exposed flank. If there is a large gap

between attacking platoons, the reserve may follow between them.

#### 54. Security

a. Security is the responsibility of each leader in the company, regardless of the measures taken by higher commanders. The company commander plans for security against enemy air and ground action, including armor attack. Security measures are designed to provide sufficient warning of enemy attack to permit necessary repositioning of forces or other action to meet the threat.

b. The company may attack with one or both flanks exposed. In order to protect an exposed flank, the company commander may: position all or part of his reserve so as to protect the flank; use combat patrols to protect the flank; and/or plan fires to cover likely avenues of approach into the flank.

c. Connecting groups, which periodically report the location of the flank of adjacent units, add a degree of security by providing the company commander with information regarding the situation on the flank.

d. The close-in security of the command post is normally provided by personnel available at the command post under the supervision of the executive officer. The security of the command post is increased when it is located near reserve elements or weapons positions.

## **55. Plan for Reorganization, Consolidation, and Dispersal**

a. The company commander, in planning his attack, plans for the reorganization, consolidation, and dispersal of his unit after seizure of an objective, if his mission does not require immediate continuation of the attack. These plans, announced in the attack order, are necessarily tentative and may be changed as required during the conduct of the attack.

b. As a passive defense against nuclear attack, the company commander plans for dispersal to the maximum extent consistent with the requirement for defending the objective. The plan for the defense of the objective (consolidation) includes the responsibilities of rifle platoons for defending assigned areas, general position areas and missions for organic and attached weapons and tanks, use of patrols to maintain contact with the enemy, and security measures. Dispersed platoon areas for consolidation normally block approaches to the objective. He may designate contact points between dispersed platoons to further delineate areas of platoon responsibility. His plan for reorganization includes such items as special instructions regarding ammunition resupply, vehicular movement, reporting of casualties, and movement and general location of the command post.

## **56. Plan for Continuation of the Attack**

a. When the attack is to be continued beyond the initial objective, the company commander

makes a preliminary plan. He makes this plan while formulating the initial attack, minimizing the time required for reconnaissance and troop leading after seizure of the initial objective.

*b.* The preliminary plan is based on a detailed map and aerial photograph study, knowledge of similar terrain, ground or air reconnaissance, and instructions received from the battle group commander. It includes the following: the employment of the rifle platoons and attached tanks, including any anticipated changes in formation; plans for the use of supporting weapons; changes in missions to be assigned the reserve.

*c.* The company commander includes applicable portions of the plan for the continuation of the attack in the company attack order.

## **Section IV. FIRE PLANNING AND COORDINATION**

### **57. Fire Planning**

*a.* The fire support plan supports the plan of maneuver and is formulated concurrently with the plan of maneuver. The fire support plan is the company commander's decision on the use of all available fires, including those of organic, attached, and supporting weapons. This plan includes targets to be taken under fire, time of delivery of fire, duration of fire, types of fires and weapons to be used, means of communication, and time for displacement where applicable. The

plan is based on his plan of maneuver, information received from battle group, information of the enemy, the terrain, and the recommendations of fire support unit leaders or their representatives.

b. The principal assistant to the company commander in fire planning is the artillery forward observer. The forward observer makes recommendations on the use of artillery fires and, if appropriate, air strikes and naval gunfire. Based upon the company commander's decision, he forwards requests for fires to the mortar battery. Other individuals available to assist the company commander in fire planning are the weapons platoon leader and leaders or representatives of attached or direct support units. These individuals make recommendations on the use of fires of their units. Leaders of organic and attached units also make recommendations concerning position areas and methods of displacement for their units.

c. In developing his fire support plan, the company commander considers such items as the nature of the target, effects desired, weapons capabilities, and availability of ammunition. In general, he plans fires to neutralize known and suspected enemy positions to permit the rapid movement of maneuver elements to seize and consolidate the objective. These fires may be planned as scheduled or on-call fires. Often the fires available will not, be sufficient to neutralize all known or suspected enemy positions simultaneously. Consequently, the company commander

must decide which enemy positions are likely to have the greatest effect on the accomplishment of the mission during various phases of the attack, and he plans fires to engage these targets at appropriate times. On-call fires may be planned to cover likely enemy avenues of approach into the flanks of the company, and to support the consolidation of the objective. Plans are normally made to provide the greatest concentration of fire on enemy positions on the objective just prior to the assault.

*d.* The company commander will be notified of the approval or disapproval of fire requests submitted to higher headquarters. He will alter or amplify his fire support plan to conform to these fire support allocations.

*e.* Fire support from a unit in contact may be made available to an attacking rifle company passing through or around its position. If such support is directed, the company commanders concerned coordinate and integrate the additional supporting fires into the attacking company's fire support plan.

*f.* The company commander may assign the reserve platoon(s) the mission of supporting the attacking platoons by machinegun fire. See paragraph 53a(3). When assigning such a mission, the company commander normally designates initial position areas and targets for these weapons.

*g.* Smoke can be used effectively to reduce hostile observation and conceal the attacker's maneuver, to mark targets, and as visual signals.

As the use of smoke must be approved by the highest echelon affected by the smoke, the company commander generally coordinates with the battle group.

*h.* Chemical fires are usually authorized and coordinated by higher headquarters.

*i.* Portable or mechanized flame support may be provided. The company commander integrates the use of flame into his fire support plan.

*j.* Tactical air support may be furnished to the rifle company on an immediate request or preplanned basis. Preplanned requests in support of the company plan of maneuver are submitted to the battle group S3 Air. Immediate air strikes may be obtained against targets of opportunity by requests through command channels to the battle group S3 Air, or through the artillery forward observer.

*k.* The company commander insures that communications are adequate to control fires during the attack. Preplanned control measures may include radiotelephone brevity codes, visual signals such as pyrotechnics, or time schedules to be used in shifting, lifting, or calling for fires, as appropriate.

*l.* For additional discussion of fire planning and coordination, see FM 7-40.

## **58. Utilization of Organic and Attached Weapons**

The following methods of utilization are appropriate for weapons organic and attached to the rifle company. The method selected for a



given situation should provide for the maximum support to the attacking platoons, greatest flexibility, and most effective control that can be achieved under existing conditions.

*a. General Support.*

- (1) General support requires the firing unit to provide support to all, or the major portion, of the company. The company commander retains overall control of the fires and movement of the unit. He designates initial target areas, specifies general position areas, and controls displacement. He exercises control of the unit through its leader who selects specific weapons positions, exercises fire control, controls the unit during displacement, and accomplishes resupply.
- (2) The desirable characteristics of general support include flexibility in massing and shifting fires, continuity of support, ease of control, and simplicity of resupply. The company commander employs the 81-mm mortar squads in general support whenever centralized control will permit delivery of fires in support of all or the major portion of the company throughout the zone or along the axis of advance. The company commander employs the antitank squads in general support whenever centralized control will permit these squads to provide antitank protection to the company, or if appropriate, close fire support for

the attacking platoons. Considerations in determining this capability include the ability of the company commander to control the squads throughout the attack and the ability of the squads to move rapidly throughout the area of operations to meet an armored threat. Forward observers of the weapons platoon are positioned as directed by the company commander (par. 74).

- (3) Attached fire support units are employed in general support whenever the capabilities of the weapons, control considerations, and the mobility of these units will permit them to provide the desired fire support while under centralized control.

*b. Direct Support.* When a fire support element is in direct support of a unit, it is responsible for delivering its fires in support of that unit. When the supported unit does not require these fires, the direct support unit may honor other fire requests. The direct support unit leader selects firing positions and controls displacement in order to provide the support desired. This method of utilization is seldom employed at rifle company level.

*c. Attachment.* Attachment of one unit to another causes control of the attached unit to pass from the parent unit to the commander to which attachment is made. When the rifle company commander has fire support elements attached to his company he may use them in general support,

direct support, or further attach them. Weapons under company control may be attached to a rifle platoon if the platoon is to operate beyond effective range of the weapons if retained under company control, or when a platoon is operating over terrain that makes it extremely difficult for the company commander to exercise control of these weapons.

*d. Reinforcing Fires.* Reinforcing fire support units have the mission of adding their fires to those of other fire support units. For example, the 81-mm mortars of a reserve company may be ordered to reinforce the 81-mm mortar fires of an attacking company. The reinforcing unit establishes direct communication with the reinforced unit to minimize the time required to answer calls for fire. It displaces as requested by the reinforced unit and keeps the parent unit commander so informed. The commander of the reinforcing unit regards a request as an order unless it conflicts with orders of his commander.

## **Section V. CONDUCT OF THE ATTACK**

### **59. General**

*a.* Once launched, the attack is conducted aggressively until the objective is seized. Attacking units move forward as rapidly as possible, keeping the enemy off balance and allowing him no time to react. Enemy weakness is exploited whenever detected. Leaders at all echelons re-

main flexible, altering plans as required by the situation.

b. The company commander locates himself where he can best influence the action of the company. He makes maximum use of the chain of command within his company to insure efficient operation and control. He makes a continuing estimate of the situation and is alert to the possible courses of action open to him when new and changing situations occur. He remains constantly abreast of the situation and keeps his subordinates and the battle group commander informed at all times. When a situation develops which is beyond the capability of the company, the company commander requests assistance from the battle group commander.

c. The company commander influences the action by his personal presence, by the control and efficient use of his supporting fires, and by the timely and efficient employment of his reserve.

#### 60. Movement From Assembly Area to Line of Departure

a. The movement forward from the assembly area is frequently made under control of the executive officer, based upon instructions from the company commander. Departure from the assembly area is timed so that the movement to and across the LD will be continuous, or if an attack position is used, that the company will arrive at the attack position at the appropriate time (par. 50b). The order of march prescribed

should facilitate deployment into the initial attack formation or occupation of the attack position, as appropriate. Multiple routes forward may be used to facilitate deployment while on the move. Weapons elements may precede the remainder of the company in order to occupy firing positions.

b. If an attack position is used, platoons post security and occupy assigned areas generally in their initial attack formations. Final preparations for the attack are completed. Movement from the attack position is timed so that the leading elements of the company cross the LD at the prescribed time.

c. If the company is to pass through another unit already in contact, the movement should be made rapidly and with the greatest possible secrecy in order to minimize the possibility of enemy nuclear attack. Responsibility for the zone normally passes from the unit in contact to the attacking unit upon passage of lines.

## **61. Line of Departure Through the Assault**

a. Using the cover and concealment provided by the terrain and the protection afforded by the supporting fires, the attacking platoons move rapidly toward their assigned objectives. If an attacking platoon is subjected to effective small-arms fire before launching its assault, the platoon returns fire. The platoon leader may request supporting fires to neutralize the enemy position. Depending upon the mission, the platoon may bypass the neutralized enemy positions and continue toward its objective, or it may employ fire and

maneuver to destroy the enemy resistance. If the attack echelon is subjected to hostile artillery or mortar fires, it moves rapidly through or around the impact area. Leaders are particularly alert and aggressive in such cases to prevent loss of control. The use of cover and concealment, supporting fires, and rapidity of movement reduce the ability of an enemy observer to adjust fire on advancing troops.

b. Platoons move forward aggressively to seize terrain from which fire (particularly that of automatic weapons) can be delivered against enemy positions. Due to variance in enemy resistance at different points, differences in terrain, and variations in the effectiveness of supporting fires, some units may advance while others are held up. Platoons not stopped by enemy fire continue forward to their objectives even though adjacent units are halted. This advance may outflank enemy resistance holding up adjacent units, making it possible for flanking fires to be delivered against the enemy and for other elements to maneuver against his flank or rear.

c. The company keeps abreast of the progress being made by his attacking platoons by observation and through radio and messenger contact with his platoon leaders. Throughout the attack, he closely coordinates the movement of his attack echelon and the fires of supporting weapons. To save time and reduce casualties, he keeps the attack progressing rapidly under the protection of supporting fires. He orders the displacement of the reserve in order to keep it close enough to

the attack echelon to permit rapid commitment (par. 53). He anticipates situations requiring the commitment of the reserve and develops plans for its future employment (par. 62). As flank security requirements change during the attack, he adjusts security measures accordingly. Based upon recommendations of fire support unit leaders, he orders the timely displacement of weapons in general support so as to provide continuous support to the attacking platoons. He orders the timely displacement of the command post to keep it close enough to the attack echelon for effective control.

*d.* Strong enemy action may halt the advance of the company in spite of the use of all available supporting fires and the commitment of the reserve. In such a situation, the company consolidates the ground already seized and continues to place fire on the enemy. No withdrawal is made except on orders of the battle group commander. Consistent with orders from the battle group commander, the company commander attempts to maneuver elements to strike the enemy flanks and rear. Every effort is made to overcome the resistance rapidly to permit resumption of the advance.

*e.* Attacking troops move as close to the enemy positions on the objective as possible before launching the assault. The assault line may be selected at this time, or the tentative assault line selected prior to the attack may be changed, if necessary. The location from which the assault is launched is determined by the platoon leader,

or if a coordinated assault by two or more platoons is to be made, by the company commander. In either event, it is as close to the enemy positions as supporting fires will permit the attacking troops to move without suffering an excessive number of casualties. It is often less costly to move so close to supporting fires that some casualties are sustained than to assault enemy positions over a greater distance, thus giving him opportunity to return effective fires.

*f.* Supporting fires on the enemy positions increase in intensity as the attacking troops approach the assault line. The attack echelon opens fire on the objective (if it has not already done so) as it deploys for the assault. This fire begins before the supporting fires are shifted or lifted in order to maintain fire superiority. If possible, the final deployment and launching of the assault are made without a halt at the assault line.

*g.* The shifting or lifting of support fires, normally controlled by the company commander, must be coordinated closely with the advance of the assaulting troops. This is accomplished through his observation of the assaulting troops and reports of signals from his platoon leaders. As the assault is launched, those fires which are dangerous to the assaulting troops are shifted, while others continue to fall on the enemy positions. Frequently, the fires of larger caliber weapons (heavy mortars and howitzers) must be shifted, because of dispersion, while 81-mm mortars and direct fire weapons can continue to fire.



Normally, as the fires of direct fire weapons are about to be masked by assaulting troops, they are shifted by the gunners.

*h.* The assault is made aggressively, using assault fire. It is continued through the depth of the objective, allowing the enemy no opportunity to reorganize or reoccupy his defenses. Direct fire weapons are displaced forward rapidly when their fires become masked.

## **62. Employment of the Reserve**

*a.* The reserve is committed to insure accomplishment of the mission. Preferably it is committed against enemy weakness rather than against enemy strength. The reserve may be used to exploit an advantage gained by the attack echelon or to maintain the momentum of the attack. Every effort is made to avoid committing the reserve through a platoon which is disorganized as a result of enemy action or which has suffered excessive casualties.

*b.* When the reserve consists of more than one platoon, the company commander commits only the number of reserve platoons necessary to accomplish a specific purpose. He commits the entire reserve without hesitation when necessary.

*c.* During the attack, the company commander keeps the reserve platoon leader(s) informed of plans for the anticipated employment of the reserve.

*d.* When the company commander commits his reserve, he immediately informs the battle group

commander of the fact, and he reconstitutes a reserve as soon as possible.

### **63. Action Following Seizure of an Objective**

*a.* Consolidation and dispersal commence immediately upon seizure of the objective. Plans announced in the attack order are revised as necessary. The company commander reports the seizure of the objective to the battle group commander. If appropriate, preparations are made for continuation of the attack.

*b.* Reorganization is continuous throughout the attack. It includes the reassignment of personnel to key jobs made vacant by casualties, reestablishment of the chain of command, and redistribution of ammunition. During reorganization after seizure of the objective, the situation, strength, and ammunition status are reported to the battle group commander. Ammunition is brought forward and issued as required, and casualties evacuated. Enemy information is reported and prisoners are sent to collecting points.

*c.* Consolidation of an objective is the organization of the ground for defense. In order to reduce vulnerability to nuclear attack while retaining the capability of defending the objective, elements of the company normally occupy dispersed positions covering approaches to the objective. For example, the objective itself may be occupied by one reinforced platoon or less, with the remainder of the company dispersed to positions from which they can assist in repelling a counter-attack. Troops and weapons are positioned as

rapidly as possible, as the enemy may counter-attack soon after seizure of the objective.

*d.* During the consolidation, organic and attached weapons are displaced forward rapidly and integrated into the overall plan for the defense of the objective area. Possible routes of enemy counterattack are covered by direct and indirect fires.

*e.* To prevent possible surprise and to maintain contact with the enemy, patrols operate to the front and flanks, and contact is established with adjacent units.

*f.* The company commander may use his reserve in the consolidation by positioning it to block an exposed flank or to extend the depth of the defense already occupied by the attack echelon.

#### 64. Continuation of the Attack

Where the attack is to be continued beyond the initial objective, the halt on the initial objective is as short as possible, consistent with orders from the battle group commander. Having previously made a tentative plan for the continuation of the attack, the company commander makes a reconnaissance and alters and amplifies his tentative plan as necessary. His order for the continuation of the attack is normally fragmentary.

### Section VI. RIFLE PLATOON

#### 65. General

*a.* The mission of the rifle platoon and rifle squad is the same as for the rifle company—to

close with and destroy or capture the enemy. The mission of the weapons squad is to furnish close fire support and antitank protection to the rifle platoon.

b. The rifle platoon normally attacks as part of a coordinated company action; however, for short periods of time the rifle platoon, with attachments, may be employed as a semi-independent force. Using the fires of organic, attached, and supporting weapons to neutralize the enemy, the platoon maneuvers to an advantageous position from which to close with the enemy. Fire and maneuver are used within the platoon during the attack. When possible, the platoon maneuvers against the flank or rear of the enemy.

c. In the attack, the mission of the platoon is normally to seize one or more terrain objectives. In addition, the company order will assign the platoon either a zone of action, an axis of advance, a direction of attack, or a combination of these measures. For a discussion of these control measures and accompanying responsibilities, see paragraph 50.

d. For a discussion of the rifle platoon as part of the company in the attack see paragraphs 59 through 64, 82 through 93, and 96 through 107. For infantry-tank team operations, see paragraphs 75-81.

#### 66. Preparation for the Attack:

a. The platoon leader normally receives a warning order prior to the attack, giving him fragmentary information and instructions on the time and place to report to receive the company

order. Based on this information, he issues his warning order to his subordinates and starts the platoon preparations (par. 48). The platoon leader, normally accompanied only by a messenger, reports to receive the company attack order. The platoon sergeant may also accompany him when it appears his assistance will be needed in reconnaissance and effecting coordination. The platoon is supervised in its preparations for the attack by the platoon sergeant or senior squad leader, as appropriate.

b. The platoon leader's actions are organized so as to make best use of the available time prior to the attack. These actions, stated generally here, are discussed in detail in appendix III. Usually, the platoon leader sends his messenger back to guide the squad leaders forward to receive the platoon attack order, unless the company commander has made arrangements to bring them forward. Having received the company order, the platoon leader coordinates with adjacent and supporting unit leaders and, if a passage of lines is to be made, with the leader of the unit through which the platoon is to pass. He conducts his reconnaissance, making a thorough terrain analysis. Based upon his estimate of the situation (app. II) he formulates his plan of attack, which consists essentially of a plan of maneuver and a fire support plan. While these two portions of the plan of attack are discussed separately, they are made concurrently, as they are interrelated.

## 67. Platoon Plan of Maneuver

a. The plan of maneuver is essentially the plan for the employment of the rifle squads to accomplish the assigned mission. It should be simple and flexible and should achieve maximum surprise. The following should be included:

- (1) *Route.* The route selected should take advantage of available cover and concealment, supporting fires, and should if possible, direct the attack at the enemy flank or rear.
- (2) *Formations.* The platoon leader selects an initial attack formation, and he may be able to foresee changing to other formations during the conduct of the attack. The choice of formations is affected to a great degree by the route selected. The formation is also influenced by the need for security, control, flexibility, and speed. For appropriate platoon formations, see appendix V.
- (3) *Assault.* If possible, the platoon leader selects a tentative assault line, if not already designated by the company commander. In selecting this line, he considers how close the platoon will be able to approach indirect fires falling on the objective; the possibility of masking direct fires; and available cover and concealment. Normally the platoon assaults from one direction with all three rifle squads.

(4) *Consolidation.* For consolidation of the objective, the platoon leader designates the area of responsibility for each squad and a general location for each organic and attached crew-served weapon to repel the counterattack. The most desirable method of assigning areas of responsibility is to point out terrain features which mark the limits of each area. Often such terrain features will not be visible, in which case the platoon leader uses the clock system. To use this system, an imaginary clock is placed on the objective with the center of the clock on the center of the platoon objective. The 6 o'clock to 12 o'clock axis is specified on the ground by the platoon leader as extending from one outstanding feature to another, visible in the area, usually in the direction of attack. Squad sectors and weapons position areas are assigned by hour numbers (fig. 10).

(5) *Control.* In planning for control, the platoon leader selects his position in the formation and plans how to use the platoon sergeant. Oral orders, personal contact, and arm and hand signals are normally used to control the platoon.

b. It may be desirable to designate a reserve squad (or squads) to protect an exposed flank, to attack from a new direction, or to take over the mission of another squad. The platoon leader

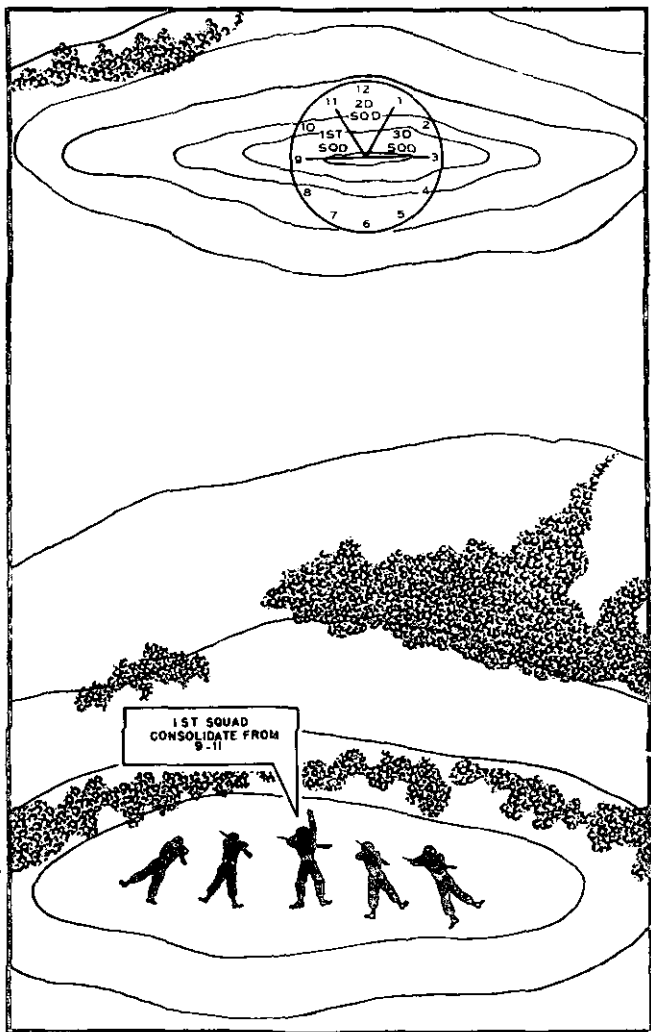

*Figure 10. The clock system may be used for consolidation of the objective.*



plans to retain this reserve near his maneuver element, usually under cover so it is not subjected to the same fire as the attacking squads. This can be done by having a larger gap than usual between the leading squads and the reserve in the formation. However, the reserve should be kept moving so that it does not fall beyond communicating distance from the platoon leader. The *entire* platoon should assault together, even though a reserve may be desirable initially. However, it may be desirable to retain a reserve, even in the assault, when the platoon is on a semi-independent mission.

#### **68. Platoon Fire Support Plan**

a. Normally, fires of weapons of the company and higher units are planned to support the attack by neutralizing enemy positions while the platoons maneuver to close with the enemy. These fires, announced in the company order, are considered by the platoon leader to determine if they will adequately support his plan of maneuver. Frequently, the platoon leader will be accompanied by an 81-mm mortar forward observer, who can assist him in fire planning. If the platoon leader desires additional supporting fires, he requests them from the company commander.

b. In addition to considering nonorganic supporting fires, the platoon leader plans the employment of organic and attached weapons. If available supporting fires are inadequate to support his plan of maneuver, he may be forced to

have one or more rifle squads provide additional fires. In planning for fire to support his maneuver plan, he is primarily concerned with having organic and attached weapons furnish close fire support for the platoon maneuver element along the route to the objective. The platoon leader's plan for organic and supporting weapons includes:

(1) *Initial employment.* The platoon leader designates general firing positions and assigns targets. His decision on the employment of these weapons is influenced primarily by observation and fields of fire available.

(a) *Machineguns.* If positions are available near the LD which afford observation and fields of fire over the route to the initial objective, both machineguns may occupy these positions just prior to H-hour. If a portion of the route is obscured from these positions, best fire support may result if one gun occupies a position near the LD while the other accompanies the maneuver element. If no fields of fire and observation exist over the route from positions near the LD, both machineguns should accompany the maneuver element.

(b) *Rocket launchers.* Consistent with their limited effective range, the rocket launchers are used generally as described for the machineguns.

Usually they will accompany the maneuver element until suitable firing positions become available. If no armor threat exists, the rocket launchers are normally used to fire on other appropriate targets. The platoon leader may plan to employ only one rocket launcher team for firing, with the other team being used to carry ammunition for the weapons squad.

- (c) *Attached weapons.* The platoon leader's plan for the use of attached weapons is based on the observation, fields of fire, characteristics of the weapon, and upon the recommendations of the leader of the attached unit.
- (2) *Along the route.* Plans are made for the weapons to displace to new positions as their fires are masked by the advance of friendly elements, or when control becomes difficult.
- (3) *Employment during the assault.* Machineguns, rocket launchers, and attached weapons should be in position to cover the movement of the rifle squads in the assault. They provide maximum fire support during the assault, continuing to fire until masked by the advance of friendly troops.
- (4) *Consolidation.* General locations are designated for each weapon on the objec-

tive. Routes for displacement to the objective should permit rapid movement and early occupation of positions covering dangerous avenues of approach for a counterattack.

- (5) *Control.* The platoon leader plans to keep his organic and attached supporting weapons within communicating distance so that he can control the fire throughout the attack. If this is not feasible, the platoon sergeant and/or weapons squad leader may be used to assist in this control. Plans are made for special measures, such as visual signals.

#### 69. Issuance of the Platoon Order

At the appropriate time, the platoon leader assembles his subordinate leaders, including attached unit leaders, and issues his attack order. Before issuing his order, he orients his subordinates from a vantage point, if possible. If such is not possible, the platoon leader uses an improvised sand table or sketch. In issuing his order, he follows the standard operation order sequence and includes only such information as his subordinates will need to know. Following issuance of the order, he asks questions of his subordinates to insure that the order is thoroughly understood (app. IV).

#### 70. Actions of Squad Leaders

Upon receipt of the platoon attack order, the squad leaders make their reconnaissances, if time

permits, and formulate their plans. Their actions are as described in appendix III.

*a. Rifle Squad Leader.* While on reconnaissance, the rifle squad leader studies the terrain, paying particular attention to the route, landmarks on which to guide, and known or suspected enemy positions. Based on his estimate of the situation (app. II), he plans the actions of his squad from the time it crosses the line of departure through consolidation of the objective. He plans in detail his assigned tasks, any anticipated action at danger areas along the route, such as seizing critical terrain short of the objective, and his squad's part in the assault and consolidation.

*b. Weapons Squad Leader.* During his reconnaissance, the weapons squad leader selects exact firing positions for weapons (including both primary and alternate positions) according to the platoon leader's instructions. He pays particular attention to targets, routes to weapons positions, routes for displacement, and the route that the maneuver element will take to the objective.

*c. Issuance of Orders.* The squad leaders issue their orders, if time permits, in the assembly area. Since the squad members normally will not see the terrain prior to the attack, the squad leader uses an improvised sandtable or sketch to orient them. Often the available time will be so limited that the squad leader must issue his order while moving forward from the assembly area or in the attack position. The squad order is issued in the standard operation order sequence.

## 71. Conduct of the Attack

a. *General.* Since control is one of the most difficult tasks confronting the platoon leader in the attack, he makes maximum use of the chain of command. As the attack progresses, he remains constantly abreast of the situation. He anticipates situations that could develop and keeps his plan of attack flexible.

b. *Assembly Area to Line of Departure.* The rifle platoon normally moves forward from the assembly area under company control, except when multiple platoon routes are used. Often the platoon will be under the command of the platoon sergeant or senior squad leader for this movement. Elements of the weapons squad may precede the remainder of the platoon in order to occupy firing positions. If no attack position is used, deployment into the initial platoon and squad attack formations is accomplished and bayonets are fixed on the move. If an attack position is used, it is here that the platoon deploys into the initial attack formation, posts security as required, and accomplishes last minute coordination. The movement from the attack position is timed so that the leading elements of the platoon cross the LD at the specified time.

c. *Line of Departure to the Assault Line.* The maneuver element of the rifle platoon makes a rapid and continuous advance from the LD to the assault line. Maximum use is made of cover, concealment, and supporting fires, including smoke. In the event a reserve squad(s) is designated, the leader(s) of the reserve squad(s) keeps

the squad (s) close enough to the leading elements so as to maintain communication with the platoon leader, to keep abreast of the situation, and to plan for likely employment of the squad (s).

- (1) Elements of the weapons squad and attached weapons occupying positions near the LD support the forward movement of the maneuver element as planned. The squad leader or gunner specifies the method and rate of fire and gives the command to open fire on indicated targets as required. Sufficient fire is placed on a target to neutralize it, but consideration is given to conserving ammunition for other targets during the attack. The squad leader or gunner observes the progress of the maneuver element and engages targets which threaten it. When both machineguns (or rocket launchers) are located close together, the squad leader anticipates the masking of fire and displaces the weapons by team echelon, one team displacing before the fires of the other team are masked. When the weapons are separated, teams may displace under control of the gunners when their fires are masked or when troops get beyond supporting distance.
- (2) If the platoon is subjected to artillery or mortar fire along the route, it moves quickly through or around the impact area, depending on the size of the area.

- (3) When enemy resistance is encountered short of the objective, fire is returned immediately by those squads in position to fire and by organic and attached supporting weapons. The platoon leader requests additional supporting fire as appropriate. Depending on the location and nature of the resistance and on the assigned mission, it may be possible to neutralize the position by fire and bypass it, with such action being reported to the company commander.
- (4) When bypassing is not appropriate, aggressive action is taken to eliminate the resistance by maneuvering against it, since the continued application of fire alone will normally result in a stalled attack and unnecessary casualties. If a squad is in a position to maneuver, the squad leader quickly makes an estimate of the situation to determine if he can, with the use of fires, close with and destroy the enemy. If this is not possible, the squad continues to deliver fire, pending instructions from the platoon leader. If it is possible, the squad leader attempts to maneuver one fire team over a covered and concealed route to strike the enemy flank or rear (fig. 11). He uses battle drill as appropriate (app. VI). Fire superiority over the enemy is necessary before maneuver can be accomplished.





*Figure 11. The squad attack using fire and maneuver.*

- (5) Essentially the squad fights by the use of fire teams, with one team maneuvering while the other team supports this movement by fire. Upon receiving the squad leader's signal or command, the team leaders initiate the action directed. If necessary, team leaders repeat the signal or command given by the squad leader. Throughout the action, the team leaders act as fighter-leaders. Team members base their actions on their team leader. Team leaders participate in the fight like other members of the team, exercising control primarily through example. The team leader uses more positive means of control when necessary. The squad leader coordinates the actions of the teams. He locates himself where he can best control and influence the action.
- (6) When the enemy resistance is first encountered, the platoon leader also makes an estimate of the situation. Because of his location well forward in the formation, he will be able to see the action being taken by the leading squads. When it appears that fire and maneuver by one squad will be sufficient to overcome the resistance, he directs this action if not already initiated. He insures that the other squads assist this action by fire and that they do not interfere by also employing fire and ma-

neuver. If it appears initially that more than one squad will be required to overcome the resistance, he quickly formulates a plan and gives the necessary commands or signals. Prompt response by the platoon leader is necessary in order to properly control and coordinate the action. Platoon battle drill is used as appropriate (app. VI). The platoon leader attempts to maneuver elements to strike the flank or rear of the enemy position. When the enemy resistance is destroyed, the platoon continues rapidly toward its assigned objective.

*d. The Assault.* As the platoon approaches the assault line, the platoon leader anticipates the time that the platoon will be ready to launch the assault and notifies the company commander. This allows the company commander sufficient time to coordinate the lifting and shifting of the supporting fires.

- (1) The location of the assault line is based on the volume of effective enemy fire and how close the platoon can actually get to the indirect supporting fires falling on the objective without accepting excessive casualties. The tentative assault line selected prior to the attack is changed if appropriate. As it approaches the assault line, the platoon deploys rapidly so that no delay occurs. Organic and attached supporting weapons are positioned to support the assault.

- (2) Unless there is a shortage of ammunition or a possibility of surprising the enemy, each individual of the rifle squads opens fire on the objective as he comes into position for the assault. This insures that fire is being placed on the objective as the indirect supporting fires begin to shift. The platoon leader orders the assault on his own initiative or on order of the company commander.
- (3) The company commander determines the time for shifting various indirect fires by his own observation, reports from subordinates, and reports from fire support unit leaders and observers. Fires of direct fire weapons are shifted on order of their own unit leaders or when the gunner sees that his fire is about to become masked. Supporting fires may be placed forward and to the flanks of the objective as the assaulting troops close with the enemy.
- (4) Under the active supervision of the platoon leader, platoon sergeant, and squad leaders, the platoon advances in the assault with squads as skirmishers. The riflemen move forward aggressively, firing an aimed shot from the shoulder every 2 or 3 paces at known or suspected enemy positions. Squad snipers participate in the assault like other riflemen. As the riflemen close with the enemy (less than 35 yards), they move more

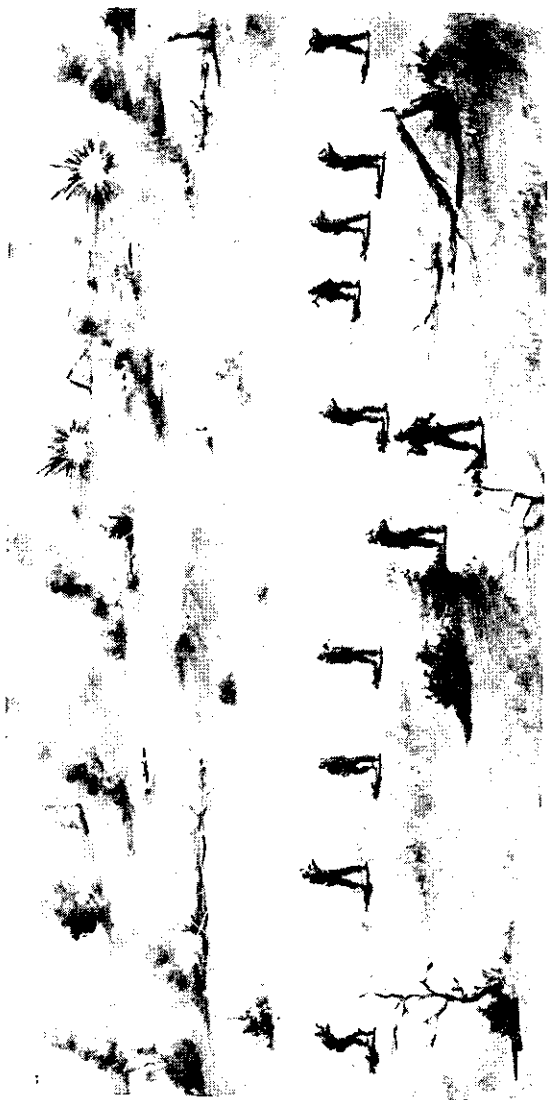

*Figure 12. Assault fire used when closing with the enemy.*

rapidly, firing from either the shoulder or underarm position without pausing. Throughout the assault, they fire at every location in their own zone of advance that might conceivably contain an enemy. When an enemy exposes himself or when a definite target appears, the riflemen fire a well-aimed shot (fig. 12). The assault is characterized by the volume and accuracy of fire and violence of action. It is designed to kill and demoralize the enemy, and to keep him down in his hole until the squad can close with and kill or capture him. The automatic riflemen fire from the hip in short bursts, covering the squad front. Hand and rifle grenades and flamethrowers may be used to overcome pockets of resistance, such as bunkers.

- (5) All squads guide on the base squad. The base squad leader designates a base fire team within his squad. In other squads, the fire team closest to the base squad is designated as the base fire team. Squad leaders normally do not fire; they take positions at the rear of the line where they can move quickly to control the fire, maintain alignment, and keep the assault moving aggressively. The fire team leaders move in the assault line in the center of their teams. In addition to assisting the squad leader

in controlling the fire and the rate and direction of movement, they participate in the assault fire. In situations where control is more difficult, they may move in rear of their teams. The fire team leaders assist in controlling the squad by setting the example and by initiating action as fighter-leaders.

- (6) During the assault, the platoon leader usually positions himself behind the base squad or wherever his presence is most needed. The platoon sergeant is positioned to the rear of a flank or a separate squad. All leaders insure that the formation is maintained, that a heavy volume of accurate fire covers the objective, and that the assault moves forward aggressively. As the noise of battle will normally make control by voice difficult, it will frequently be necessary for each leader to move quickly to the point where his presence is needed to make certain that his commands are understood and carried out.
- (7) In the event resistance is encountered which causes the forward movement to slow down or be stopped, the platoon leader and squad leaders must single out specific enemy position(s) offering the resistance and employ fire and maneuver against it. It is important in this situation that the platoon and squad leaders realize that the objective now

becomes the specific enemy position(s) offering resistance, rather than the entire terrain feature itself.

- (8) The assaulting troops, having closed with the enemy, clear the enemy's positions and move over the objective far enough to place fire on any withdrawing elements.

*e. Reorganization and Consolidation.*

- (1) Immediately after capturing the objective, the platoon occupies a position to repel a possible counterattack. If the company dispersal plan calls for movement of the platoon from the objective itself, the platoon normally halts on the objective only if necessary to regain effective control. If the attack is to be continued beyond the objective, the platoon normally remains in position to repel a counterattack until the attack is resumed.
- (2) Plans for consolidation made prior to the attack serve as a basis for the organization of the assigned area and adjustments are made as required by the situation. Squads are assigned sectors of responsibility and security is posted to warn of enemy approach. Squad leaders, assisted by fire team leaders, assign individual positions and sectors of fire. Automatic rifles are located to cover critical approaches into the squad areas. Men start digging in immedi-



ately. Organic and attached supporting weapons are positioned to cover possible routes of enemy counterattack. A brief consolidation report is made to the company commander. The platoon leader inspects the platoon area and continues to improve the defenses. If the attack is to be continued, leaders make reconnaissance, formulate plans, and issue necessary fragmentary orders.

- (3) Reorganization is a continuous process which is given special emphasis upon seizure of the objective. Key men who have become casualties are replaced; ammunition is redistributed; and situation, strength, and ammunition reports are given by the squad leaders to the platoon leader and by the platoon leader to the company commander. Ammunition is brought forward, casualties are evacuated, and prisoners are moved to the rear.

## **Section VII. WEAPONS PLATOON**

### **72. General**

*a. Mission.* The mission of the weapons platoon in the offense is to furnish close and continuous fire support for the attacking rifle platoons and to provide antitank protection for the company.

- (1) *Antitank squads.* The primary mission

of the antitank squads is to provide anti-tank protection for the company. The squads have a secondary mission of providing close fire support to the attacking rifle platoons.

- (2) *81-mm mortar squads.* The mission of the 81-mm mortar squads is to furnish close and continuous fire support to the attacking rifle platoons.

*b. Employment.* The company commander directs the employment of the weapons platoon to support the company attack (par. 58).

### **73. Preparation for the Attack**

*a.* The weapons platoon leader normally accompanies the company commander to receive the battle group attack order. Prior to his departure, the platoon leader issues a warning order to his platoon sergeant. After receipt of the battle group order, the company commander may direct the weapons platoon leader to accompany him on his reconnaissance or to conduct a separate reconnaissance. Based upon the battle group order, the company commander's concept for the attack, and his reconnaissance, the weapons platoon leader formulates recommendations on the employment of his platoon. If general support appears to be feasible, he also prepares recommendations on general position areas, disposition of forward observers, methods of displacement (par. 74), and targets (par. 57). During his reconnaissance, the platoon leader makes a thorough terrain analysis. He selects

principal directions of fire for the antitank squads and firing position areas dependent upon the company commander's approval of his recommendations. During this time, the platoon prepares for the attack, normally under supervision of the platoon sergeant.

b. If the company order attaches some squads to rifle platoons, the weapons platoon leader insures that those squad leaders report to their respective platoon leaders as soon as possible. When time permits, the platoon leader makes additional reconnaissance after the company attack order is issued. His actions are as described in appendix III. He issues his attack order as soon as possible, giving the squad leaders maximum time to make their preparations. Whenever possible, he orients his leaders on the terrain. If a terrain orientation is impossible, he uses an improvised sandtable, map, or sketch. In addition to other information, his order includes the method of utilization of each squad, and if in general support, the general position areas, disposition of the mortar forward observers, principal directions of fire and targets for the antitank squads, and tentative plans for displacement.

c. The squad leaders, in turn, make their reconnaissance, select exact firing positions, and coordinate to determine the routes to be used by the rifle platoons. They normally issue their squad orders in the assembly area.

d. When a squad is attached to a rifle platoon, the squad leader makes recommendations to the rifle platoon leader on the employment of his

squad, to include the general position area, targets, and plans for displacement. The rifle platoon leader controls the squad.

e. As soon as possible, the platoon leader (assisted by the platoon sergeant and the fire direction computers) prepares a plan, usually in overlay form, of 81-mm mortar concentrations planned as scheduled or on-call fires to support the attack. This plan is given to the forward observers and to the company commander, generally in enough copies for issue to the rifle platoon leaders.

#### 74. Planning and Conduct of the Attack

##### a. *General.*

- (1) During the attack, the weapons platoon leader positions himself to assist the company commander in the employment of his platoon. He may remain with or near the company commander or he may position himself elsewhere, so as to best observe the advance of the attacking platoons and control the employment and displacement of his squads simultaneously. The platoon sergeant performs such duties as the platoon leader directs. He normally accomplishes or supervises ammunition resupply and supervises the 81-mm mortars when in general support. The two rocket launchers organic to platoon headquarters are used to provide close-in antitank protection as directed by the platoon leader.

- (2) Throughout the attack, the weapons platoon leader makes timely recommendations to the company commander concerning the employment of the weapons. He recommends method and time for displacement, changes in the method of employment of one or more of the squads necessitated by changes in the situation, and recommendations on best utilization of fires. He keeps the company commander informed of the status of ammunition supply, especially when hand-carry of mortar ammunition is involved.
- (3) During the attack, radio is the principal means of communication. It is supplemented by wire and other means whenever possible.
- (4) The weapons platoon leader specifies the manner in which ammunition will be resupplied to the squads, based on the company plan. A primary duty of the platoon sergeant is the supervision of this resupply. Frequently the company commander will utilize some of the  $\frac{3}{4}$ -ton trucks and trailers of the platoon to establish the company ammunition distributing point to resupply ammunition to all platoons. Depending upon the number of vehicles available to the platoon, ammunition resupply may be accomplished by: using a  $\frac{3}{4}$ -ton or the  $\frac{1}{4}$ -ton truck and trailer to carry am-

munition to the squads; locating a  $\frac{3}{4}$ -ton trailer with ammunition at the mortar position, to be replaced with a full trailer as it becomes empty; in exceptional cases having the antitank squads secure ammunition directly from the company ADP using their organic vehicles; using carrying parties; or vehicles under company control distributing ammunition directly to the squads.

- (5) Reorganization is continuous. No specific halts could be made for reorganization because of the danger of stopping and slowing the operation.

*b. Antitank Squads.*

- (1) *Control.* The antitank squad leaders may take their orders from either the company commander or the weapons platoon leader, or if attached to a rifle platoon, from the rifle platoon leader.
- (2) *Targets.* The primary target for the 106-mm rifles is enemy armor. If the antitank squad is firing in close support of a rifle platoon and an enemy tank appears, the squad leader immediately takes the enemy tank under fire. Targets which the squad may engage in a close support role are point targets, such as crew-served weapons, small groups of enemy personnel, and bunkers or pillboxes. To insure immediate availability of ammunition for their primary

role, the 106-mm rifles will usually fire on definitely located point targets only.

- (3) *Selection of firing positions.* The anti-tank squads are normally employed individually. They are positioned to cover likely enemy armor approaches into the company zone or along the axis of advance, or to permit close fire support for the attacking platoons, depending on their assigned mission. If possible, positions are selected which will permit the squads to provide both antitank protection and close fire support from primary positions. Positions that permit flanking and oblique fires on enemy armor are desirable. It is also desirable that selected positions provide partial defilade for both gun and crew. It may be necessary due to enemy action to place the gun in complete defilade and move it into firing positions only when lucrative targets appear. Alternate and supplementary positions are selected.
- (4) *Occupation of firing positions.* The antitank squads move from the assembly area or from previous firing positions in sufficient time to occupy new firing positions. The squad leader designates the exact position and also how the position is to be occupied. A route should be selected which permits occupation of the position without observation by the enemy. Positions that cannot be oc-

occupied except under enemy observation are occupied rapidly at the last possible moment. The antitank rifle may be held in defilade and driven into firing position only when its fires are required. In such cases, the squad leader acts as an observer, giving adequate and timely orders to the crew.

- (5) *Displacement.* The antitank squads displace on order when they can no longer accomplish their assigned mission from their initial positions. Both squads may displace at the same time to support the lead elements of the company; or, one of the antitank squads may remain in position while the other squad displaces in order to provide antitank protection for the company flanks and rear. Displacement is made by vehicle over previously planned routes. The antitank squad leader insures that he has a maximum load of ammunition on carrier before beginning his displacement.

*c. 81-mm Mortar Squads.*

- (1) *General.* When the squads are employed in general support, they normally fire from one centrally located position area with one fire direction center. When a mortar squad is attached to a rifle platoon, 1 forward observer, 1 radiotelephone operator, and 1 fire direction computer accompany each attached mortar squad so that it will be



capable of establishing its own FDC. An attached squad normally relies on wire for communication between the observer and the mortar position. When the squads are operating from a central firing position, the platoon leader may direct the senior squad leader to supervise the squads.

- (2) *Targets.* The mortars generally engage area type targets. The most effective fire is observed fire. However, during periods of poor visibility, the FDC can place fire on the enemy by computing data from maps or by adjusting from previously fired concentrations.
- (3) *Selection of firing positions.* The information required for selecting the mortar position can be obtained from a map, a terrain reconnaissance, and, for displacement, from information from FO parties accompanying the attacking platoons. The following factors should be considered when selecting firing positions for the 81-mm mortar:
  - (a) The mortar position is normally well forward in the attack in order to take advantage of the greater accuracy of the mortar at shorter ranges and to provide fires for as long as possible before being required to displace. Initial objectives should be within the effective close support range of the

mortars if possible. As a guide, the mortar can provide close support to attacking troops to ranges of about 2,000 yards. At ranges greater than 2,000 yards, the mortar can continue to support, but dispersion of the rounds will require the early shifting or lifting of fires to prevent inflicting casualties on the attacking troops. The minimum range of the mortar must also be considered in selecting the position to permit delivery of close fire support to the attacking platoons as they cross the LD.

- (b) The position should allow mortar coverage of all rifle platoon objectives and the critical terrain between and to the flanks of these objectives.
- (c) The position should be in defilade and should allow for mask and overhead clearance to enable the mortars to fire at minimum and maximum elevations.
- (d) Routes of supply should be short, covered and concealed, and permit vehicular movement into firing positions if possible.
- (e) Alternate positions are selected. Movement to them is ordered by the platoon leader, or in his absence the senior squad leader, when enemy fire threatens the mortars and crews. Supplementary positions are also selected to permit coverage of areas

which cannot be covered from primary or alternate positions. When the mortars move to alternate or supplementary positions, the company commander is notified immediately.

(f) The position should allow adequate dispersion between mortars.

(4) *Occupation of firing positions.*

(a) The mortar squads move from the assembly area or from previous positions in sufficient time to occupy the new firing position and, if possible, register the mortars prior to the attack. The platoon leader may start the squads moving prior to issuance of his attack order; the determining factors are the distance involved and the time required for initial preparation of positions.

(b) The mortar squads will usually move by vehicle to the new firing position. Upon occupation, the vehicles are dispersed in a covered and concealed area nearby or released to company control, as appropriate ((a) above). When the terrain and enemy action prevent vehicular movement, the mortars and ammunition must be hand carried. Since the mortar squads have insufficient personnel in the event of a hand carry, arrangements must be made for outside assistance. The mortars are emplaced; the squad leaders are given

initial firing data; one mortar is designated as base mortar and all other mortars are then laid parallel. Mask clearance is checked prior to firing. When the squads are ready to fire, the company commander and the forward observers are notified.

- (5) *Forward observers (FO)*. There are three forward observer parties in the platoon, each consisting of an FO and a radiotelephone operator. These FO parties are positioned as directed by the company commander. One FO party is normally assigned to each of the attacking rifle platoons. One party may accompany the company commander or be assigned to the reserve. Prior to the attack, the FO establishes an observation post to make initial registration of planned fires. During the attack, the FO parties remain with or near the rifle platoon leader to whom they are assigned. When a mortar squad is attached to a rifle platoon, an FO party is also assigned to that platoon.
- (6) *Fire direction center (FDC)*. When the squads are employed in general support, the three fire direction computers establish and operate the FDC located at or near the mortar firing positions. It is normally located close enough to the mortar positions so that commands may be given by voice. Fire requests are

received by the FDC, the data is computed, and fire commands are sent to the mortars. The platoon leader, platoon sergeant, or the senior fire direction computer decides the number of weapons to be used and the number of rounds to be fired for each fire request. When a mortar squad is attached to a rifle platoon, a fire direction computer is also attached. He locates himself at the mortar position and computes firing data.

- (7) *Displacement.* Displacement is made by vehicle when the terrain, enemy situation, and availability of vehicles will permit. The weapons platoon leader may accompany the displacing squad(s). There are three methods by which the 81-mm mortars may displace when employed in general support.
- (a) *Three echelons.* This method is normally used when sufficient time is available, since it permits two squads to continually be in position, ready to fire. One squad displaces with sufficient personnel to establish a new FDC. When no radio is available for the new FDC, wire communication must be used to register and fire this squad. The second squad does not begin displacement until the first squad reports that it is ready to fire. One fire direction computer accompanies each mortar squad during dis-

placement. This is the slowest method of displacement but is desirable when the attack is slow enough to allow its use.

- (b) *Two echelons.* When displacement is begun while fire missions are numerous, only one squad displaces initially; when fire missions are few, two squads displace initially. In either case, sufficient personnel accompany the initial echelon to establish a new FDC. This method is faster than displacement by three echelons and still enables the mortars to provide continuous fire support.
- (c) *As a unit.* This is the least desirable method because it does not permit the mortars to provide continuous fire support.

## **Section VIII. INFANTRY-TANK TEAM**

### **75. General**

a. One or more tank platoons may be attached to the rifle company to form an infantry-tank team. Normally the team will consist of a rifle company with one platoon of tanks attached. The rifle company commander commands the team.

b. In the attack, the company commander normally employs an attached tank platoon as a unit under company control, since the tank platoon can generally operate most effectively in this manner. He may attach tank sections (of which there are two in a tank platoon) to rifle platoons

to facilitate control when conditions of observation and terrain limit the ability of the tank platoon leader to control his entire platoon. Examples of such conditions are when fighting in jungles, dense woods, mountainous terrain, and cities.

*c.* Based upon the recommendations of the tank platoon leader(s), the rifle company commander decides which method(s) of attack will be used and how the tanks and infantry will move in relationship to one another. If a tank section is attached to a rifle platoon, the rifle platoon leader makes these decisions after receiving recommendations of the tank section leader.

*d.* Mutual support and teamwork between tanks and infantry is essential. Infantry and tank leaders at all echelons closely coordinate their plans of action. Tanks may assist the infantry by destroying enemy armor and weapons positions and by breaching lanes through barbed wire and antipersonnel minefields. The infantry may assist the tanks by locating and destroying enemy tank-hunter teams, maneuvering against antitank gun positions, and breaching or locating routes through or around obstacles. During the conduct of the attack, tank commanders and infantrymen communicate with one another by radio, visual signals, personal contact, and by use of the external interphone on the rear of the tank.

## **76. Methods of Attack**

There are three general methods of employing

the infantry-tank team in the attack: tanks and infantry attacking on the same axis; tanks and infantry attacking on two converging axes; and tanks supporting by fire only. One or more of the above methods may be used. As the combat situation changes, it may become necessary to employ a method of attack other than the one initially used. The attacking unit must be capable of changing from one method to another as the attack progresses. Although the combination of methods used may change and the techniques of their application vary, the tank must be employed to make maximum use of its battlefield mobility, armor-protected firepower, speed, and shock action.

## **77. Infantry and Tanks Attack on the Same Axis**

*a. General.* In this method, one axis is used by both tanks and infantry to approach the objective. This facilitates coordination and control and permits close mutual support. The avenue of approach selected must be suitable for the maneuver of both tanks and infantry.

### *b. Dismounted Infantry and Tanks.*

- (1) When tanks and dismounted infantry attack on the same axis, the tanks may initially support the advance of the infantry by fire. As the infantry approaches the assault line, the company commander orders the tanks forward for the assault phase. If the enemy defenses on the objective are hastily pre-



pared and lack overhead cover, the movement of the tanks may be so timed that they pass through the infantry and assault the objective under artillery and mortar time fire, followed closely by the assault of the infantry. When enemy positions on the objective cannot be neutralized by time fire, the movement of the tanks is so timed that they join with the infantry at the assault line, and both infantry and tanks assault the objective together. In either case, the movement of the tanks forward from their initial firing positions must be carefully timed to prevent either tanks or infantry from halting at the assault line.

- (2) Infantry and tanks may advance together when a need for close mutual support is indicated or when no positions exist from which the tanks can initially support by fire (fig. 13). The infantry may move slightly in advance of the tanks (being sure not to mask their fires), between them, or immediately in rear. As the advance progresses, the relative positions of tanks and infantry are adjusted according to the enemy resistance and the terrain. This technique of movement permits close coordination and maximum mutual support but sacrifices the speed of the tanks,

making them more vulnerable to anti-tank fires.

*c. Mounted Infantry and Tanks.* In a mounted attack, mounted infantry and tanks may advance either in an integrated formation (fig. 14) or with the mounted infantry following the tanks by bounds (fig. 15). The tanks lead so as to best utilize their firepower and to provide protection to the armored carriers. The armored carriers should be so located in the formation that their vehicular machineguns can augment the fires of the tanks, unless such positioning would unduly expose the carriers to antitank fire. Mounted infantry following the tanks by bounds increases



*Figure 13. Tanks and dismounted infantry attacking together on the same axis.*

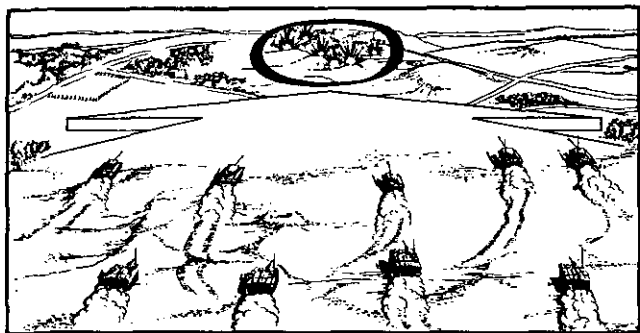
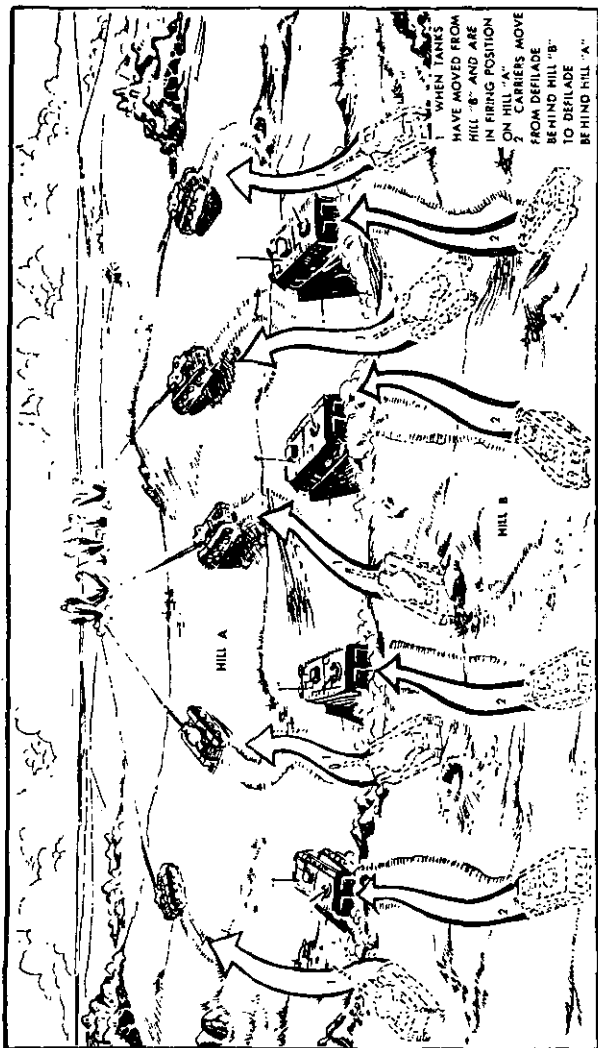

*Figure 14. Mounted infantry and tanks advancing in integrated line formation.*

the security of the carriers from antitank fires. Carriers should remain close enough to the tanks to permit mounted infantry to dismount and rapidly provide close-in protection for the tanks if necessary.

## **78. Infantry and Tanks Attack on Two Converging Axes**

*a.* This method calls for the attacking force to use two different axes to approach the objective (fig. 16). It has the advantages of providing the maximum opportunity to achieve surprise and strike the enemy flanks and rear, and of forcing the enemy to fight in two directions simultaneously. Favorable approaches for both infantry and tanks are necessary. The infantry may advance on one axis and the tanks on another; however, this does not deny the possibility of sending both tanks and infantry on each axis. Coordina-



*Figure 15. Mounted infantry following tanks by bounds.*



Figure 16. Infantry and tanks attacking on two converging axes.

tion of the assault is more difficult than when using one axis.

*b.* Tanks may initially support the movement of dismounted infantry by fire, even though infantry and tanks are attacking on different axes. The movement of the tanks may be timed so that they assault the objective first under time fire, or tanks and infantry may converge on the objective simultaneously. When both tanks and infantry are attacking on one or both of the axes, the coordination of their movement on each axis is as described in paragraph 77*b*. Mounted infantry are preceded by tanks as discussed in paragraph 77*c*.

### **79. Tanks Support by Fire Only**

Using this method, the infantry attacks to seize the objective and the tanks support the attack by fire only (fig. 17). This is the least desirable of all methods and should be employed only when conditions exist that prevent the physical presence of the tanks in the assault. Even though the shock action and some measure of the firepower of the tanks are lost, they may be used effectively. As soon as the obstacles are breached or a suitable avenue of approach is uncovered, the tanks should rejoin the attacking infantry as rapidly as possible. Conditions dictating the use of this method are present when—

*a.* Obstacles exist short of the objective which the tanks cannot bypass and which cannot be reduced before the objective is seized.

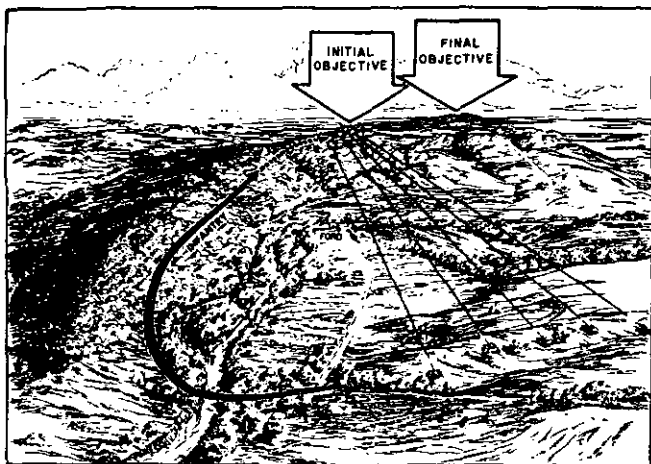

*Figure 17. Tanks supporting by fire only.*

b. Terrain must be seized which is completely impassable to tanks.

### **80. Infantry Utilizing the Tanks for Transportation**

When there is a requirement for the rapid advance of tanks and infantry and no armored carriers are available, infantrymen may ride on the tank decks. This means of transportation may be used effectively in an effort to regain contact with the enemy; in the exploitation of nuclear weapons, including the crossing of CBR contaminated areas; or when the terrain and the enemy situation indicate that fewer casualties will result from rapid movement than from a dismounted advance. However, infantrymen mounted on

tanks are extremely vulnerable to all types of fire, and the maneuverability and firepower of the tanks are reduced. The infantrymen normally must dismount immediately upon being brought under effective small-arms or antitank fire, or when dismounted infantry action is required.

### **81. Reorganization, Consolidation, and Dispersal**

Upon assaulting the objective, tanks move aggressively through the depth of the objective and then move to hull defilade positions from which they can cover likely enemy armor approaches and aid the infantry in repelling counterattacks. Although the company attack order designates tentative areas where the tanks will be positioned during the consolidation, adjustment of these plans may be necessary. Resupply of the tanks is accomplished as required either on the position itself or in a covered area immediately to the rear. If movement of the tanks is required for resupply because of enemy fire, they move back individually or by section. Crew maintenance is performed as the situation permits.

## **Section IX. MECHANIZED RIFLE COMPANY IN ATTACK**

### **82. General**

a. A unit is considered to be mechanized when all or the major portion of that unit has armored carriers attached. A rifle company will most fre-



quently be mechanized in fluid operations, when rapid movement over great distances is required. Examples of such operations include attacks against light or discontinuous enemy resistance and in exploitation of the successes of other units or of nuclear weapons. For a discussion of the company as part of an attack by a mechanized battle group, see FM 7-40.

*b.* In the attack, the mechanized rifle company will normally have enough armored carriers attached to mount all the rifle platoons and may have enough to mount the mortar squads also. These carriers provide the company primarily with armor protected mobility and, to an extent, with additional firepower. For a discussion of the characteristics, capabilities, and limitations of armored carriers, see FM 55-37.

*c.* The tactics and techniques in planning and conducting the attack described in paragraphs 49 through 64, 94 and 95 generally apply to a mechanized attack also, except as discussed in this section.

*d.* For purposes of discussion in this section, a mounted attack is one in which attacking rifle platoons are mounted in carriers during any portion of their movement forward of the LD.

### **83. Terrain Considerations**

Track vehicles operate most effectively over rolling terrain, where their maximum cross-country mobility may be used. Consideration should be given, however, to the use of less favorable avenues of approach if they offer a greater opportunity to achieve surprise. Close terrain,

such as woods, may limit the speed of movement as dismounting of infantry may be required to provide protection against enemy tank-hunter teams. Terrain obstacles are considered not only for their effect against track vehicles but also as they affect wheel vehicles transporting supporting weapons.

#### **84. Enemy Defenses**

Enemy defenses will have a considerable effect on the selection of routes and on the ability to move mounted in the attack. The presence of enemy armor, enemy antitank defenses, emplacements having overhead cover, and artificial obstacles are particularly important. As overhead cover will make air-burst artillery and mortar fires ineffective against enemy personnel so protected, mounted movement in proximity to such positions will normally be impracticable. Enemy armor, antitank defenses, and obstacles may preclude or greatly restrict mounted movement forward of the LD until these elements or positions can be destroyed or neutralized by dismounted action or other means. Against hastily prepared positions having weak antitank defenses, mounted movement may be possible all the way to the objective.

#### **85. Control**

a. Control during the attack is exercised primarily by radio and visual means, augmented as necessary by motor messenger. Because of the limited communication facilities available, the

rifle platoon leader normally must rely entirely on visual signals to control his platoon while mounted. The unit standing operating procedure may contain detailed procedures on the use of visual signals, including the use of arm and hand signals, flag signals, panels, pyrotechnics, smoke grenades, and smoke streamers.

*b.* Control measures:

- (1) An attack position is utilized less frequently for a mechanized attack than for a dismounted attack. Considerations in selecting an attack position (if used) are the same as for a dismounted attack, except that the area selected will generally be considerably larger.
- (2) The company is normally assigned an axis of advance. Less frequently, a zone of action may be assigned, though the requirement for clearance of a zone is exceptional. The company commander may assign axes or zones of action to his attacking platoons. Zones assigned should be large enough to permit maneuver of the mechanized platoons. Normally, to facilitate a rapid advance, platoons should not be required to clear their zones of enemy resistance unless the company zone must be cleared.
- (3) Check points are particularly appropriate to assist in control during a mechanized attack.
- (4) As the use of intermediate objectives tends to slow the attack, they usually

are designated less frequently for a mechanized attack than for a dismounted attack. Intermediate objectives may be required when it is anticipated that fire support elements (including antitank protection) will not be able to keep up with the attack echelon. The need for the close and continuous support of these elements must be weighed carefully against the advantages which might result from the rapid, uninterrupted advance of the attack echelon.

- (5) The company commander normally selects a dismount area(s) forward of the LD, where his attack echelon dismounts from its carriers. This area may be short of the assault line, at the assault line, or on the objective. The dismount area should be covered and concealed, if possible, and it should be as far forward as the terrain and the enemy situation permits. The dismount area selected during the planning of the attack is a *tentative* location which may be changed during the attack should the situation permit or require such a change. The selection of the dismount area is based upon the company commander's estimate of how far forward his attack echelon can move mounted before becoming vulnerable to enemy tanks, antitank guns, obstacles, or tank-

hunter teams. Consideration is given to the protection afforded by tanks attached to the company, by supporting fires (including time fire over the advancing carriers), by the terrain, and by the effects of nuclear weapons on enemy defensive positions. Normally, the dismount area is located on the objective only when tanks are attached to the company and when enemy positions on the objective can be effectively neutralized by fire.

- (6) An assault line is selected even though mounted movement onto the objective is planned. In such a case, the assault line should be suitable for use by dismounted troops in the event early dismounting is forced by enemy action.

## **86. Attached Tanks**

The attachment of tanks has a pronounced effect on the ability of the company to make a mounted attack. When operating without tanks, the ability of the company to move forward of the LD mounted is greatly curtailed because of the vulnerability of the carriers to tank and anti-tank fires. A mounted attack without tanks is normally feasible only when the enemy defenses have been so devastated (as by nuclear fires) that the possibility of effective enemy reaction is remote. When tanks are attached, they provide protection for the carriers by destroying enemy tanks and antitank weapons. In addition,

friendly tanks draw fire which otherwise might be directed at the carriers. In a mounted attack, tanks are usually employed in the attack echelon as the lead element, as described in paragraph 77. Tank platoons are normally employed as units under company control.

### **87. Employment of Armored Carriers**

*a.* When sufficient armored carriers are attached to the company to mount all the rifle platoons, the company commander normally further attaches four carriers to each rifle platoon (the number required to mount a platoon) and retains one as his command vehicle. When additional carriers are available, they are normally attached to the weapons platoon for use by the mortar squads.

*b.* Should only enough carriers be attached to mount a portion of the company, the company commander must determine how best to utilize them to further the accomplishment of his mission. Based on the situation and his plan of attack, he may attach them to the platoon(s) of the reserve, or he may attach them to his attacking platoons. A mounted reserve provides great flexibility in that the reserve may be moved rapidly to influence the action as required. If the attacking platoons are to be mechanized, careful consideration must be given to the likelihood of separation of the attack echelon and the reserve, subjecting the company to defeat in detail.

*c.* The platoon leader normally further attaches

one carrier to each of his squads. The squad leader commands the carrier (including its driver) and, under the supervision of the platoon leader, is responsible for its positioning, movement, camouflage, and all other aspects of its employment while attached. The platoon leader and platoon sergeant command those carriers in which they ride while they are actually mounted.

### **88. Formations**

The considerations involved in selecting a company attack formation are basically the same, whether the company is mechanized or dismounted.

a. A column formation will be used more frequently for a mounted attack than for a dismounted attack, since the company will generally be attacking to seize deep objectives and the enemy situation will often be obscure. Within the column, elements are located in order of anticipated commitment, with tanks normally leading.

b. The number of tanks attached to the company may affect the company commander's decision in selecting a formation for a mounted attack. For example, the number of tanks attached may not be sufficient to provide the needed protection for more than two mounted rifle platoons in the attack echelon.

c. For a discussion of mounted rifle platoon formations, see appendix V.

### **89. Plan for Use of the Reserve**

The mobility of a mounted reserve allows the

company commander greater flexibility in planning for its use than if dismounted; it gives it a greater capability to accomplish a number of missions simultaneously. For example, it may be capable of providing flank security for both flanks and maintaining contact with adjacent units, while retaining the capability of maneuvering rapidly over large distances to influence the action of the attack echelon. Positioning of the reserve near an exposed flank or near the area of anticipated commitment may not be required as with a dismounted reserve, thus permitting greater dispersion within the company. Normally the reserve remains mounted initially. The plan of attack may call for its movement by bounds, or when rapid movement is anticipated, it may be ordered to follow an attacking platoon at a specified distance.

## **90. Security**

As the mobility of the reserve permits it to move rapidly to meet an enemy threat on a flank, primary consideration is given to providing adequate warning. Mounted flank patrols, moving by bounds from one piece of dominating terrain to the next as the attack progresses, may be used. In determining the number of squads (carriers) to be used as flank patrols, consideration should be given to the resulting depletion of the reserve and to the provision of adequate communications to these patrols. Observation in the area may provide adequate security without the use of patrols.



## **91. Fire Support Planning**

*a.* Since the movement of mounted maneuver elements is rapid, detailed planning and coordination of supporting fires are essential to permit the timely delivery, shifting, and lifting of fires. Flexibility of fires to meet unforeseen situations is mandatory.

*b.* Maximum consideration is given to the use of supporting fires to protect the movement of tanks and carriers. Emphasis is placed on the neutralization of known or suspected enemy anti-tank weapons. Smoke may be used to screen the forward movement and the dismounting of the infantry in the dismount area. Artillery and mortar VT and time fires may be used effectively to provide protection from short range antitank weapons when the enemy does not have the protection of overhead cover. Friendly small-arms fire delivered around the vehicles also provides a degree of protection. When it is planned to move mounted onto the objective, the use of such indirect and direct fires is normally mandatory, and careful planning is required to provide for exact timing in the shifting of these fires.

*c.* In planning the use of the organic supporting weapons of the weapons platoon, the company commander visualizes the displacement of these weapons in relation to the movement of his maneuver elements. Plans are made for the exclusive use of nonorganic fires during periods when continuous fire support cannot be provided by organic means, as during a very rapid advance.

In such a situation, the 81-mm mortar squads may advance in the column with their weapons on carrier until the need arises for their support. The 106-mm rifle squads are normally employed in general support and may be used to provide antitank protection to the flanks of the company, with tanks providing this protection to the front.

## **92. Conduct of the Attack**

*a.* Movement forward and across the LD is continuous, with deployment into the initial company and platoon attack formations being accomplished on the move if possible. If the use of an attack position is mandatory, the halt there is as short as possible.

*b.* Mounted movement forward of the LD is made as rapidly as the terrain, speed of the vehicle, and use of supporting fires permit. Vehicle commanders observe from their turrets until forced by fire to close the hatches. During the forward movement, the .50 caliber machineguns on the carriers may be fired at known or suspected enemy positions. Tanks and carriers of the attack echelon advance as described in paragraph 77.

*c.* During the advance, the infantry dismount rapidly in any situation requiring dismounted action. In some situations, a portion of the movement forward of the LD must be made through close terrain, such as woods, in which visibility is greatly reduced. In such terrain, detection of enemy tank-hunter teams is very difficult; consequently, infantry must dismount to provide the

necessary close-in security for the carriers and tanks. Movement through the close terrain is continued at the rate of advance of the dismounted infantry. When the close terrain has been crossed, personnel remount, and the advance is continued.

*d.* Movement is made mounted as far forward as possible. Based upon his continuing estimate of the situation, the company commander may decide to change the tentative location of the dismount area announced in his attack order.

*e.* Upon reaching the dismount area, vehicles halt, utilizing such cover as is available, and the infantry rapidly dismounts. Maximum fires including smoke are placed on enemy positions at this time. The carriers occupy suitable firing positions (preferably in hull defilade), and the fires of the .50 caliber machineguns (manned by the driver or an infantryman) support the dismounted advance of the infantry. The attack continues dismounted as described in paragraphs 61 through 64. Normally, infantry and tanks assault the objective together.

*f.* When the dismount area is located on the objective, carriers and tanks move rapidly to that area (with hatches closed) under artillery and mortar time and VT fires. Upon reaching the dismount area, supporting fires are shifted or lifted, and the infantry dismounts immediately to eliminate any enemy who may remain on the objective. The exact timing of the shifting of fires is of great importance. The last rounds of the concentration may be colored smoke to indi-

cate to the infantrymen inside the carriers when to dismount. Often remaining enemy elements on the objective can be eliminated by dismounted attack from the rear.

*g.* If the carriers receive unexpected effective tank or antitank fire prior to reaching the dismount area, the platoon leader must determine *immediately* what steps must be taken to dismount the infantry under the safest conditions possible. Often his safest course of action is a continued, rapid movement (if cover is available) a relatively short distance forward, especially if artillery and small-arms fires are falling around the carriers. If the carriers are located on the crest of a hill when fired upon, it might be feasible for them to back into defilade, though halting the vehicles provides the enemy stationary targets. If located in the open when fired upon and no cover is available for a great distance, the platoon leader may be forced to halt his vehicles in place and dismount his platoon if continued forward movement of the vehicles would mean their probable destruction. Regardless of the circumstances, all available supporting fires, including those of the carrier-mounted machineguns, are directed at the known or suspected source of the enemy fire. The company commander, forward observers, and leaders of fire support units must be constantly alert for such an occurrence and must react without hesitation to neutralize that fire. Smoke or white phosphorus rounds fired immediately into the enemy position by direct fire weapons will greatly assist the mounted pla-

toon in moving to cover and/or dismounting. Upon dismounting, the infantry continues the attack on foot.

*h.* The company commander normally follows closely behind the attacking platoons to keep abreast of the situation and their progress. He closely coordinates the movement of his platoons and the fires of supporting weapons. As the mounted advance of the attacking echelon is often rapid, he takes particular care to insure the timely and rapid displacement of organic and attached supporting weapons to provide continuous fire support and antitank protection. It may be necessary for him to halt his attacking platoons on intermediate objectives until his weapons are in position. In some situations, the company commander may place complete reliance upon the fire support provided by higher headquarters to maintain a rapid rate of advance, rather than delay his attacking echelons until his organic and attached weapons can displace.

*i.* Because of the fluid nature of mechanized operations, situations may change rapidly. Flexibility on the part of all leaders is essential, and great reliance is placed on fragmentary orders at all echelons.

*j.* Upon seizing the objective, reorganization, consolidation, and dispersal are accomplished in much the same way as in a dismounted attack.

- (1) In the consolidation, the carriers occupy hull defilade positions to provide fire support if such positioning does not un-

duly expose the vehicles to enemy anti-tank fires. If it does unnecessarily expose them, they should be placed in a covered position immediately in rear. Some of the carriers may be positioned to provide security to the flanks and rear.

- (2) Resupply of ammunition, fuel, and lubricants for the carriers is accomplished on position if possible, or in a covered area immediately behind the position.

### **93. Pursuit**

*a.* The rifle company normally conducts the pursuit as a part of a larger unit. The pursuit starts when the enemy cannot maintain his position and endeavors to escape or retreat. Pursuit begins only upon the order of a higher commander. Once begun, the pursuit is characterized by boldness and rapidity of action and is pushed to the limit of endurance. It is continued day and night. Security measures at company level are limited in order to facilitate the advance. No opportunity is given the enemy to reorganize his forces.

*b.* To conserve the strength of troops and to provide speed, maximum use is made of vehicles and tanks to overtake, envelop, and destroy the enemy. The company may be preceded by reconnaissance elements which have the mission of finding the enemy so that pursuing rifle elements can engage him.

*c.* The company commander is allowed maxi-

imum freedom of action by the battle group commander. The battle group commander's orders usually are brief and fragmentary, giving objectives, an axis of advance, or a zone of action. Objectives are generally distant and may include such terrain features as important road junctions, stream crossings, and defiles.

## **Section X. RESERVE RIFLE COMPANY**

### **94. General**

*a. Mission.* The rifle company, as all or part of the battle group reserve, may be assigned one or more of the following missions:

- (1) Attack to exploit a temporary or newly discovered enemy weakness.
- (2) Attack from a new direction on an enemy position which, because of its strength, has halted or threatens to halt the advance of the attacking echelon.
- (3) Operate against the hostile rear area to extend an envelopment or exploit a successful envelopment.
- (4) Assume the mission of an attacking element that has become disorganized, depleted, or for any reason has been rendered ineffective.
- (5) Reduce enemy resistance that may have been bypassed by the attacking echelon or that may have subsequently developed to the rear of the attacking echelon.
- (6) Protect the battle group's flanks and rear.
- (7) Maintain contact with adjacent units.

- (8) Assist adjacent units when such action favors the accomplishment of the battle group mission.
- (9) Support the attack by fire of crew-served weapons.

*b. Movement.* The battle group order prescribes the initial location of the company. The company moves to subsequent locations on order of the battle group commander. In a mobile attack situation the battle group commander normally prescribes a route for movement of the reserve, utilizing march objectives and phase lines for control and coordination.

*c. Planning.* Since the battle group order may include more than one contingency mission for the company, several plans may be required to comply with the order. These plans are as complete and detailed as circumstances will permit. Fire support plans for various plans of maneuver normally include only on-call fires initially. Subordinate leaders are thoroughly informed of all plans to facilitate rapidity of execution.

## **95. Conduct of the Attack**

*a.* During the attack, the battle group commander may require the reserve company commander (or his representative) to accompany him until the reserve is committed. He may require the company commander to make recommendations on subsequent reserve locations or to otherwise assist in the preparation of plans for the employment of the company.

*b.* The company commander must keep himself informed of the situation at all times in



order to execute an assigned mission promptly. He aggressively seeks information by maintaining close contact with the battle group commander, by monitoring transmissions over the battle group command net, and by reconnaissance. Based upon changes in the situation, he anticipates missions which are likely to be assigned to the company and prepares plans accordingly. He keeps his subordinates informed of the situation and of these plans.

c. The battle group order committing the reserve is normally fragmentary and may or may not be according to a previously prepared plan. Similarly, the company commander's order is normally fragmentary, as time usually does not permit detailed planning or the issuance of lengthy orders.

d. When committed, the reserve is automatically relieved of any security or contact responsibilities contained in the initial battle group attack order, unless such responsibilities are specifically directed in the new order.

e. The conduct of the attack, reorganization, consolidation, and dispersal of the reserve company are carried out as discussed in section V, this chapter.

## **Section XI. NIGHT ATTACK**

### **96. General**

a. *Purpose.* A night attack may be made to gain surprise, to maintain pressure or to exploit a success in continuation of daylight operations, to seize terrain for subsequent operations, or to

avoid heavy losses by utilizing the concealment afforded by the darkness. Night attacks are a normal part of operations and become increasingly important as enemy firepower increases.

*b. Characteristics.*

- (1) Night combat generally is characterized by the following: a decrease in the ability to place aimed fire on the enemy; a corresponding increase in the importance of close combat, volume of fire and fires of fixed weapons which are laid on definite targets or target areas by daylight; difficulty in movement, maintenance of control, direction, and contact. Despite these difficulties the night attack gives the attacker a psychological advantage in that it magnifies the defender's doubts, apprehensions, and fear of the unknown.
- (2) Difficulties encountered are overcome by adequate planning and preparation and by thorough training in night operations. Normally, more time is required for planning and coordinating a night attack than a daylight attack. Thorough ground reconnaissance by leaders at all echelons is highly desirable. Because of difficulties in control, the plan of maneuver is usually simple.

*c. Techniques.*

- (1) A night attack may be made by stealth, it may be conducted using daylight techniques, or a combination of these

may be used. In an attack by stealth, an attempt is made to maintain secrecy and achieve surprise in closing with the enemy before he discovers the attack. The particular technique employed will depend on such factors as the enemy strength and degree of preparation of his positions, his security measures, the terrain, and light conditions. The situation may permit an attack by stealth to seize the initial objective, with the continuation of the attack being made utilizing daylight techniques. Other situations may require the entire attack to be conducted using daylight techniques. In any event, every effort is made to achieve the maximum degree of surprise, regardless of the techniques used.

- (2) This section deals primarily with techniques used in an attack by stealth. Certain of these techniques may be applicable even though the attack is made generally like a daylight attack.

## **97. Reconnaissance**

If possible, reconnaissance by all leaders is conducted during periods of daylight, dusk, and darkness. Reconnaissance during changing conditions of light assures maximum familiarity with the terrain as it will appear during the attack. The company commander normally limits the size of reconnaissance parties and prescribes

other limitations on reconnaissance essential to the maintenance of secrecy. Infrared or other night vision devices may be used to assist in reconnaissance and to detect the enemy use of such equipment.

### **98. Surprise and Secrecy**

Positive measures are taken to insure secrecy and increase surprise. In addition to limitations on reconnaissance parties, the movement of vehicles and weapons is held to a minimum. Light and noise discipline is rigidly enforced. Registration of weapons is avoided or accomplished in a way which will not indicate our intentions to the enemy. Significant change in any type of activity is avoided.

### **99. Control Measures**

The degree of visibility determines the measures taken to assure control. Because visibility is often poor, the limited ability to control maneuver will normally require the company to move generally in a straight line over open terrain towards its objective. Terrain features used as control measures, if not easily identifiable at night, may be marked by artificial means.

*a. Assembly Area.* The assembly area is normally assigned by the battle group commander. It may be closer to the line of departure than for a daylight attack.

*b. Release Points.* These are points at which a higher commander releases control of a unit to its commander. Company release points are

designated by the battle group commander. The platoon release point is designated by the company commander, and the squad release point is designated by the platoon leader. Platoon and squad release points are located to provide a gradual deployment during movement to the probable line of deployment. They should be located far enough back to allow completion of lateral movement before reaching the probable line of deployment, yet far enough forward to permit centralized control as long as possible.

*c. Attack Position.* An attack position is seldom needed for a night attack by stealth. If it is required, it is often designated by the battle group commander, or he may delegate its selection to the company commander. The attack position should be in defilade but need not offer as much concealment as in daylight. The area selected should facilitate movement into and out of it.

*d. Line and Points of Departure.* A point(s) of departure may be selected by the company commander. It is that point(s) on the ground where the company will cross the prescribed LD.

*e. Route.* The company commander selects the route the company will use from the company release point to the platoon release point. The platoon leader selects the route from the platoon release point to the squad release point, and the squad leader selects the route from the squad release point to the probable line of deployment. Routes selected should facilitate silent movement at night and should avoid areas where detection

by the enemy might occur, such as known enemy outposts and skylines.

*f. Probable Line of Deployment.* This is the location on the ground where the company commander plans to complete final deployment prior to moving out with squads as skirmishers. This line should coincide with some visible terrain features to assist in its identification at night. It should be generally perpendicular to the direction of the attack and as close to known enemy positions on the objective as it is estimated the company can move without being detected. If the enemy has wire obstacles in front of his position, the probable line of deployment should be on the enemy side of the obstacle, if feasible. The company commander selects the probable line of deployment if not previously designated by the battle group commander.

*g. Zones of Action and Objectives.* The company is normally assigned a zone of action and, in addition, may be assigned a direction of attack or azimuth. The company objective is usually smaller than for a daylight attack so that the company can clear its objective in a single assault. Similarly, platoon objectives should be small enough to be seized and cleared in a single assault. Assigned objectives should be designated by unmistakable terrain features. Intermediate objectives are not normally assigned. The company commander usually assigns platoon zones of action by the designation of a portion of the probable line of deployment and an objective for each platoon.

*h. Phase Line.* A phase line is frequently designated to limit the advance of attacking elements. It should be easily recognizable in the dark (a stream, road, edge of woods, etc.) and far enough beyond the objective to allow security elements space in which to operate. Fire support agencies are free to engage enemy forces beyond this line. The phase line is frequently prescribed by the battle group commander; if not, the company commander selects it.

*i. Specific Measures.* Additional measures which may be used to facilitate control include:

- (1) Use of an azimuth, mortar or artillery marking rounds, or tracers to assist in maintaining direction.
- (2) Use of guides and connecting files.
- (3) Designating a base element on which other units base their movement.
- (4) Use of infrared equipment or other night vision devices.
- (5) Prescribing distances to be maintained between individuals, squads, and platoons.
- (6) Identification of leaders and friendly troops by use of luminous buttons or tape, white armbands, etc.

*j. Provisions for Adequate Communication.* Since the use of radio will frequently be restricted until the attack is discovered, reliance is placed on the use of messengers within the company. The company commander may use wire (laid from a dispenser) for communication with the battle group commander. Pyrotechniques

may be used as emergency signals; however, their indiscriminate use may alert the enemy.

## 100. Formation

a. To assist in control, the column formation is used as far forward as practicable. If possible, deployment of the rifle squads as skirmishers is delayed until the company is within assaulting distance of the enemy positions. The principal considerations in the selection of a formation by the company commander are the visibility, distance to the objective, and the anticipated enemy reaction. Based upon these considerations, the company normally crosses the line of departure either in a column of platoon columns or in a line of platoon columns. Generally, the single file formation is avoided.

- (1) If visibility is poor, if the distance to the objective is great, or if early contact with the enemy is not expected, the company may cross the line of departure in a column (fig. 18). This formation is retained until the platoon release point is reached or unless earlier deployment is forced by enemy action.
- (2) If visibility permits control of a more open formation, the distance to the objective is short, or early contact with the enemy is expected, it may be desirable to advance from the line of departure in a company line of platoon columns (fig. 19).



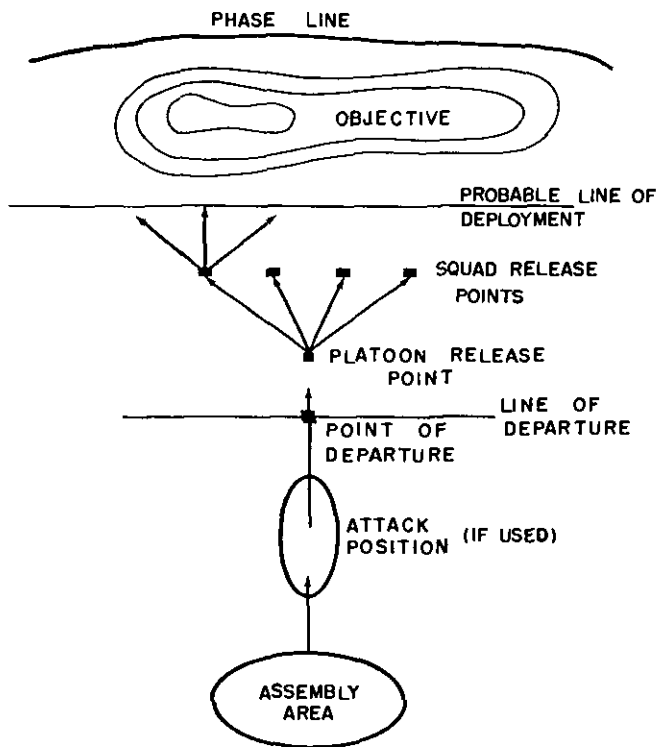
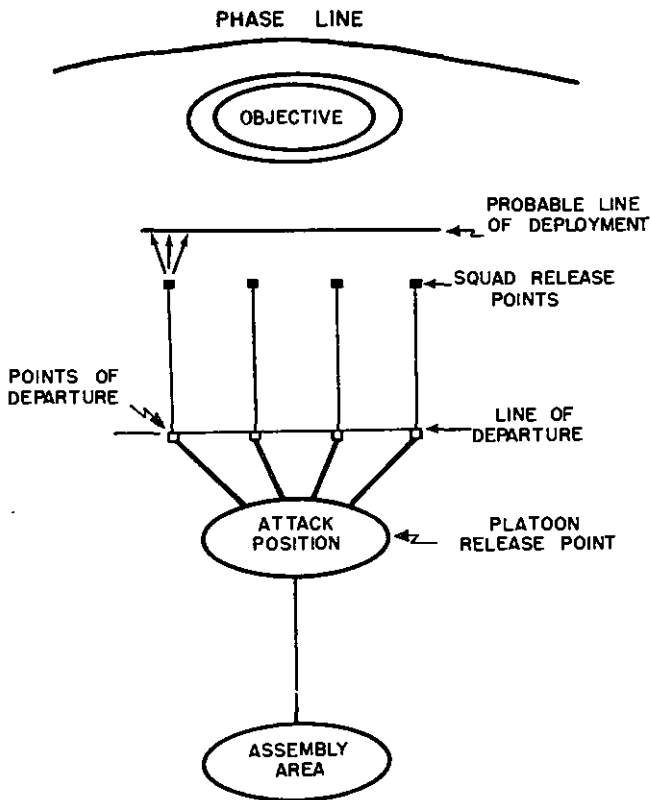

Figure 18. Night attack: company column of platoon columns.

- (3) If the company is in contact with the enemy and the distance to the objective is short, it may be necessary to have the leading squads move forward from their positions as skirmishers. In this case, the line of contact is, in effect, the probable line of deployment. If the



*Figure 19. Night attack: company line of platoon columns.*

distance to the objective is greater than assaulting distance, the company commander may plan for the platoons to assemble in position, then move to the point(s) of departure, assuming the pre-

scribed formation while moving. This movement must be closely timed and coordinated.

b. Under conditions of reduced visibility, the effective use of a reserve as a maneuver element is usually impossible because of the difficulties of control and coordination. The company commander normally employs all four rifle platoons in the assault. A reserve is usually withheld only when the zone of action for the company is extremely narrow or if there is a dangerously exposed flank or rear. If a reserve is held out to provide flank or rear security, the company commander may direct it to follow the attack echelon closely, or it may be left in rear on the LD and brought forward by guides or on signal.

## **101. Security**

a. Security patrols are normally sent out prior to the attack to secure the probable line of deployment. Also, returning patrol members furnish information of the enemy and terrain and act as guides when the company moves forward in the attack. One security patrol of 4 to 6 men is generally sent from each platoon. The company commander orients patrol leaders on the route forward to the platoon release point, on respective platoon portions of the probable line of deployment, and only such other information as they will need to know in order to accomplish their mission. Platoon leaders inform their patrol leaders of the route from the platoon release point to the squad release point and the

location of the squad release point. The company commander designates a time of departure and time of return (normally shortly before the time of attack), and a place where returning patrol members must report. Normally 1 or 2 members of each patrol return, leaving the remainder as security on or near the probable line of deployment. After reporting to the company commander, returning patrol members rejoin their respective platoons to assist the platoon leaders in guiding their platoons forward.

*b.* In addition to security patrols on the probable line of deployment, frontal and flank security is provided during the movement from the line of departure to the probable line of deployment. The size of these security elements varies with the amount of detailed information of the enemy, the terrain, and likely enemy counteraction. The distance at which these security elements operate depends primarily on the commander's ability to control them.

## **102. Use of Illumination**

*a.* The battle group commander normally determines the degree of illumination to be provided. Even though the attack is to be made by stealth, plans are made for the use of available illumination should the need for it arise. Battlefield illumination may be planned and provided on schedule or on call.

*b.* During an attack by stealth, illumination is not usually provided during the advance to the probable line of deployment. During the assault,

direct illumination by searchlights and flares may be used to blind and confuse the enemy. Illumination used to aid in consolidation after seizure of the objective is normally limited to indirect illumination (artificial moonlight). Direct illumination can be used to assist in repelling a counterattack.

*c.* If illumination is provided throughout the attack and the light intensity approximates that of daylight, the tactics and techniques used are generally the same as for a daylight attack.

*d.* Infrared illumination, in conjunction with appropriate viewing devices, may be used to facilitate movement, control, and firing of weapons.

### **103. Use of Supporting Fires**

*a.* The battle group commander specifies the conditions under which supporting weapons will be fired. If the attack is to be made by stealth, fires are planned in detail but are normally delivered only on call. Some fires may be delivered to maintain the pattern existing prior to the attack. Weapons are positioned and registered to deliver fires on call if necessary. Fires are planned on the objective to support the attack if prematurely discovered, to protect the flanks, and to isolate the objective during the assault and consolidation.

*b.* If the attack is to be made against a well fortified position, heavy supporting fires will normally be used. Illumination may or may not be used. Fires are planned and delivered generally as in a daylight attack.

## 104. Use of Organic Weapons and Attachments

*a.* The 81-mm mortar squads are normally employed in general support for ease of control and flexibility. The weapons are positioned and registered as necessary on desired target areas prior to darkness. If the objective is within effective range, the weapons may be left in initial firing positions to capitalize on the registered data until daylight or until continuation of the attack necessitates displacement.

*b.* The antitank squads are usually employed in general support also. If secrecy can be maintained, they may be moved to firing positions at dusk and laid on desired targets, prepared to deliver fires on call. If such action is likely to alert the enemy, the squads are kept in defilade behind the line of departure ready to displace to the objective once it is seized.

*c.* The weapons squad of the rifle platoon normally moves in column at the rear of the platoon during the movement to the probable line of deployment. Depending on the visibility, it may follow the assaulting squads at a specified distance, support the assault echelon, or protect the flanks and rear. The weapons squad should not be so close to the assaulting squads that it becomes involved in close combat; yet, it must be immediately available to support the consolidation. Because of difficulties in fire control, it is normally not advisable to fire machineguns in a night assault.

*d.* If tanks are attached to the company, they

are seldom used as a maneuver element except when illumination is provided or when infrared equipment available to both tank crews and infantry permits the control and coordination necessary for the use of daylight techniques. In an attack by stealth, tanks are normally kept in rear of the line of departure ready to displace to the objective upon seizure. They may be moved into firing positions and laid on targets at dusk, if such action will not alert the enemy.

e. Portable or mechanized flamethrowers may be attached to the company. Flame has a great psychological and destructive effect on the enemy at night and assists the attacker during the assault by providing some illumination. When stealth is mandatory, only portable flamethrowers can be used. Flamethrowers are generally further attached to rifle platoons and are fired only after the assault has been launched.

### **105. Plan for Reorganization, Consolidation, and Dispersal**

This plan is generally the same as for a daylight attack. The limit of advance and/or phase line prescribed by the battle group commander will restrict the area in which elements of the company can be dispersed. Because of reduced visibility, areas where platoons will consolidate should be delineated by easily recognizable terrain features. To facilitate positioning of supporting weapons and tanks, plans are made for guides to meet these elements at specified points to lead them to their position areas. Plans are

made for the designation and employment of a reserve as soon as possible after seizure of the objective. Special measures may be required to permit rapid resupply of ammunition, evacuation of casualties, and other actions during the reorganization.

## **106. Orders**

Although the plan of attack should be as simple as possible, a night attack order is normally lengthy and detailed because of the unusual number of specific control measures and special instructions which are necessary. In conjunction with the order, a thorough terrain orientation is of utmost importance.

## **107. Conduct of the Attack**

*a.* In the movement forward to the attack position, guides are used and routes are marked as necessary. The company occupies the attack position for the minimum time necessary to effect final coordination and issue last-minute instructions. Patrol members rejoin their respective platoons after reporting to the company commander.

*b.* The company commander normally leads the company forward to the platoon release point. Usually, other leaders also march at the heads of their units to facilitate control. Frontal and flank security is maintained during movement to the probable line of deployment. Once the company crosses the line of departure, movement is continuous, and the rate of advance is slow



enough to permit silent movement. Enemy encountered from the line of departure to the probable line of deployment are eliminated as silently as possible.

c. In an attack made without supporting fires, the company commander calls for those fires if, at any time during the movement forward, it becomes evident that the attack has been discovered. In this case, the company deploys from the column formation, continues rapidly to the probable line of deployment, and deploys as skirmishers; fires are shifted, and the company launches the assault as in a daylight attack. Illumination may be called for to assist in control and as a countermeasure to blind the enemy. If the company is reasonably close to the probable line of deployment when the attack is discovered, the company should be deployed rapidly, and the assault launched without hesitation.

d. If flares are fired during the movement forward to the probable line of deployment, all individuals quickly assume the prone position until the flares burn out. The times for firing friendly flares must be coordinated to insure that the company is not discovered prematurely.

e. Prior to the arrival of the company, the patrols securing the probable line of deployment should eliminate enemy listening posts in this area as silently as possible. As the squads approach, they deploy as skirmishers. Members of the security patrols assist in positioning squads on the probable line of deployment and then rejoin their own squads.

f. Normally platoon messengers report to the company commander when the platoons are in position and ready to continue the movement forward. According to orders from the battle group commander, the company commander directs the continuation of the attack. This may be done by ordering the base platoon to move out, or by other means consistent with security. The company continues the attack by moving forward *silently* in line as skirmishers without firing.

g. When the attack is discovered during this movement, the assault is begun. The authority to initiate the assault is normally delegated down to and including platoon sergeants. Under some circumstances this authority may be delegated to rifle squad leaders. Scattered fire by small elements of enemy must not be misconstrued as loss of surprise and should not be the signal to start the assault.

h. The importance of developing a great volume of fire during this phase cannot be overemphasized; it is at this time that fire superiority must be established. The assault is conducted aggressively; individuals are encouraged to shout and create as much noise as possible. Riflemen fire from the underarm position, and automatic riflemen fire from the hip position. Tracer may be used to increase accuracy of fire and to demoralize the enemy. The company commander may at this time call for supporting fires to isolate the objective and for direct illumination. The assault should be carried to the military crest on the far side of the objective.

*i.* Once the objective has been seized, platoons disperse to designated areas and consolidate. Squad and platoon leaders establish their flanks on previously indicated terrain features and gain contact with adjacent units. Local security is established, alert for a possible counterattack. Ammunition is redistributed; supplies are brought forward; key members of the company are replaced; the company command post is displaced to the objective; casualties are evacuated; wire communication is established; and status reports are made to the next higher headquarters. The company commander checks his supporting fires to determine if they cover the approaches most dangerous to the company. Organic and attached weapons may be displaced to the objective and guided into position. The company commander completes his plans, designates a reserve, and coordinates its movement as soon as the situation permits. The company normally does not attempt to mop up the enemy in an overrun area until after daylight. However, this does not prevent taking action against a pocket of enemy that interferes with the reorganization and consolidation.

*j.* If the attack is to be continued beyond the initial objective, actions are as discussed in paragraph 64.

## **Section XII. RIVER CROSSINGS**

### **108. General**

*a.* A river crossing operation has as its purpose the rapid movement of the attacking force across

a river obstacle so that the force may continue the attack to seize its assigned objective(s). River crossing operations differ from other ground attacks generally as follows:

- (1) Requirements exist for more specialized equipment and personnel.
- (2) Limited areas suitable for crossing often tend to canalize movement of the attacker.
- (3) Control of units during the attack is difficult because of the obstacle itself, restrictions imposed by space, and the employment of units of several arms and services.
- (4) Tactical courses of action are limited, since deployment and firepower are restricted while the troops are astride the river.
- (5) Once forces are committed to action, deviation from the initial plan is difficult.

b. There are two general types of river crossings: *hasty* and *deliberate*.

- (1) A crossing is termed *hasty* when it is conducted as a continuation of the attack, with minimum loss of momentum, by the same forces which advance to the river line. It is made using the crossing means at hand or readily available. A hasty crossing may be feasible when enemy defenses on the far bank are weak or when bridges or fords are captured before the enemy has a chance to destroy

them. Since this type of crossing is characterized by speed, surprise, and minimum concentration of personnel and equipment, it is normally less vulnerable to enemy counteraction than a deliberate crossing. See paragraph 110.

- (2) The *deliberate* crossing is characterized by some delay, more detailed preparation and planning, and the employment of extensive and specialized crossing means. It may be conducted as a resumption of the offense; when a hasty crossing is not desirable because of the difficulty of the obstacle or because of the strength of enemy defenses; or as a result of an unsuccessful hasty crossing.

c. For additional discussion of river crossing operations, see FM 31-60 and FM 7-40. For a discussion of the use of helicopters in river crossings, see FM 57-35.

## **109. Concept**

a. Prior to arrival of attacking troops at the river line, detailed information of the river and its defenses is obtained by higher headquarters. Whenever possible, upon arrival at the river, existing crossing means are seized prior to destruction and a hasty crossing is effected. In the event this is not possible, preparations are continued for a deliberate crossing, and enemy forces on the near side of the river are eliminated. Normally, troops other than those to make the assault crossing secure or screen the near bank.

*b.* In any river crossing the effectiveness of the river as an obstacle is reduced through surprise and deception and by the speed of the attack and buildup of forces on the far side. Every effort is made to maintain secrecy and to deny the enemy information, such as the time of crossing and location of crossing sites. Deceptive measures, such as feints and demonstrations, are prescribed and coordinated by higher headquarters. Plans may call for the extensive use of smoke.

*c.* In order to facilitate dispersion, rapidity of crossing, and deception, a river crossing is normally made on a wide front. Dispersion of units is essential to reduce the effects of nuclear and nonnuclear fires.

*d.* When adequate means are available, assault units cross in helicopters or in armored carriers. Forces so transported normally seize relatively deep objectives, with mechanized units linking up rapidly with the helicopterborne forces. When these means of transportation are not available, assault units must cross in boats. Because of the limited mobility of these forces after crossing, they are normally assigned initial objectives closer to the river than would be assigned to mechanized or helicopterborne forces. An assault company, whether in boats or armored carriers, generally crosses in two waves.

*e.* The rapid seizure of objectives and elimination of enemy resistance on the far bank are essential to permit construction of rafts, bridges, and other crossing means necessary for the rapid

buildup of forces on the far side. When the assault crossing is made by boat, clearing the far bank of effective enemy resistance is normally accomplished by attacking units. When the attacking units cross in personnel carriers to seize relatively deep objectives, this task is more frequently assigned to reserves.

*f.* Since the enemy will attempt to destroy the attacker while astride the river, the attack on the far bank is conducted aggressively to keep the enemy off balance while sufficient forces are being crossed to prevent effective enemy counteraction.

## **110. River Crossing Using Armored Carriers**

### *a. General.*

- (1) A mechanized company has the capability of making either a hasty or a deliberate crossing in areas where no additional crossing means such as bridges exist. Platoons may execute a hasty crossing as they arrive at the river when speed is essential to capitalize on a discovered enemy weakness. Tanks, antitank squads, and other fire support elements unable to cross initially, support the crossing of rifle platoons from positions on the near bank.
- (2) When armored carriers are attached to the company for a deliberate crossing, a sufficient number will normally be attached to carry all rifle platoons, and

frequently enough additional carriers will be attached to carry elements of the weapons platoon.

*b. Planning and Preparation.*

- (1) Prior to a deliberate crossing, a ground reconnaissance is made by the company commander and by as many subordinate leaders (to include vehicle commanders) as the situation and available time will permit. Emphasis is placed on selection of routes forward, selection of suitable sites for the carriers to enter and leave the water, determining conditions of the banks and the river, and locating underwater obstacles. Personnel of the carrier unit provide assistance in selecting crossing sites. The company commander selects a portion of the near bank for each platoon to start its crossing. Based on his estimation of downstream drift, he may also designate general areas on the far bank where each platoon will land. Platoon leaders select specific sites where each vehicle will enter the water and, if possible, where each vehicle will land on the far bank.
- (2) The company commander may select intermediate platoon objectives for purposes of control when it appears that a brief halt of the attacking platoons will be necessary during the crossing of the weapons platoon. Intermediate objec-



tives may not be required if sufficient carriers or helicopters are available to permit the weapons platoon to cross rapidly. Any delay of the attack echelon should be kept to a minimum because of the desirability of seizing the assigned objective quickly.

- (3) Consistent with the number of crossing sites available, a mechanized company may cross with three platoons in the first wave, with one rifle platoon and the weapons platoon crossing in the second wave. The retention of a reserve is possible because its mobility permits it to move rapidly to any one of a number of crossing sites and so be used to influence the action early in the operation. A reserve is desirable because it provides flexibility both in securing the initial crossing and in seizing the deep objective normally assigned. When terrain or other considerations restrict the effective use of a reserve early in the attack, the company may cross with four platoons in the first wave, with a reserve being designated soon after crossing.
- (4) The antitank squads generally support the initial crossing by fire from positions on the near side of the river. Plans are made to cross these squads in the second wave, as soon as possible after the seizure of the far bank to provide antitank protection for the attack echelon. Shut-

the movement of weapons and their carriers may be necessary.

- (5) The 81-mm mortars may support the initial crossing by fire from positions on the near side of the river. Plans are made to cross these squads in the second wave in order to provide close and continuous fire support during movement toward the assigned objective. When adequate nonorganic fire support is available to support the initial crossing and when rapid movement of the attack echelon is a primary consideration, the mortar squads may remain on carrier initially, prepared to cross the river immediately after the first wave.
- (6) In addition to usual preparations for the attack, specific checks of the carriers and their loads are made to insure safe operation in the water. For a discussion of these checks and of loading, see FM 17-1 and FM 55-37.
- (7) For additional discussion of attack planning, see sections III, IV, VI, and IX, this chapter.

*c. Conduct of the Attack.*

- (1) Movement forward from the assembly area is continuous and rapid. Multiple routes are used as necessary. An attack position is seldom used. Upon approaching the river, each platoon deploys in echelon formation so that the leading carrier will be downstream from the

others in the platoon, thus reducing the chances of collision in the water. During the crossing, each carrier is normally headed directly toward the far bank, and no effort is made to counteract the effects of downstream drift. Vehicular .50 caliber machineguns are fired as necessary. Upon approaching landing sites, individual carriers may be required to change direction slightly to land at a suitable spot on the far bank.

- (2) Upon reaching the far bank, vehicles continue their movement toward the objective. In the event an individual carrier cannot climb the far bank, it backs off into the water and lands at another site. Every effort is made to avoid congesting the crossing area. When the condition of the far bank prevents a sizable number of vehicles from climbing the bank, the platoon leader(s) concerned normally orders the dismounting of personnel through the top hatches and the continuation of the attack on foot. Carriers rejoin the platoon(s) as soon as possible.
- (3) The company commander normally controls the initial crossing from a vantage point on the near bank. If the initial crossing is heavily opposed and the commitment of the reserve is indicated, he orders the reserve to cross at a lightly

defended site. He attempts to maneuver the reserve to strike the enemy resistance in the flank or rear.

- (4) Upon the successful crossing of the first wave, the company commander orders the crossing of the remaining elements of the company as indicated by the situation. The interval between waves is based on such factors as enemy resistance, congestion of the crossing area and far bank, fire support requirements, and the need for speed. The company commander normally crosses in his carrier immediately after the first wave has successfully crossed. Remaining elements of the second wave need not cross simultaneously in a wave as such, but are crossed on considerations enumerated above.
- (5) Certain wheel vehicles and personnel of company headquarters which do not participate in the assault crossing are usually controlled by the executive officer. They cross as directed by battle group when means become available.
- (6) The attack on the far bank is conducted as described in paragraphs 82 through 93. If it will not threaten the accomplishment of the company's mission, enemy elements may often be bypassed. For additional discussion of the use of personnel carriers in a river crossing, see FM 17-1.

## 111. Planning a Crossing Using Boats

*a. General.* The mission of an assault company crossing by boat is usually to seize as its initial objective terrain which will prevent the enemy from placing effective direct small-arms fire on the crossing site. The near edge of the river is normally designated as the LD. Although they may be made during daylight or darkness, crossings at night (or under other conditions of reduced visibility) will be frequent. The time of attack, specified by higher headquarters, may be such that the placing of boats and movement of attacking troops to the river are accomplished during darkness, with the actual crossing being timed so that the first wave will land on the far bank at or shortly before dawn.

*b. Reconnaissance.* A ground reconnaissance is made by the company commander and as many subordinate leaders (to include boat team leaders) as the situation and available time permit. Every effort is made to insure that reconnaissance activities do not compromise the secrecy of the operation. An engineer officer usually assists the company commander during this period, making recommendations and providing technical assistance. Items of particular concern during the reconnaissance are routes forward, the attack position, boat positions and launching sites, condition of the banks and the river, and plans of the engineer unit. The company commander selects the portion of the near bank where each platoon will begin its crossing, and he may designate general landing areas on the far bank.

Each platoon leader selects the specific launching site for each boat of his platoon and, if possible, landing sites on the far bank.

*c. Attack Position.* The company attack position is normally selected by the battle group commander. The company commander specifies portions of the attack position for each of his subordinate elements. The attack position is generally the location where infantry troops and the boats with engineer crews are brought together. The company is dispersed in the attack position to the maximum extent possible, consistent with accomplishment of the mission, as a passive means of protection against nuclear attack.

*d. Boat Positions.* The company commander specifies to the supporting engineers the locations where the boats will be placed in preparation for the crossing. Boat positions are normally in the attack position, close enough to the river to permit easy carry by the platoons. Boats for each platoon are placed directly in rear of their launching sites. Should the attack position be more than about 300 yards from the river, boat positions closer to the river are selected if possible.

*e. Objectives.* Because the initial objective assigned the company is normally relatively close to the river, selection of intermediate platoon objectives is usually unnecessary. Considerations in selection of objectives are contained in paragraphs 49 through 56.

*f. Formation.* The initial company formation is usually four platoons. Normally no reserve is

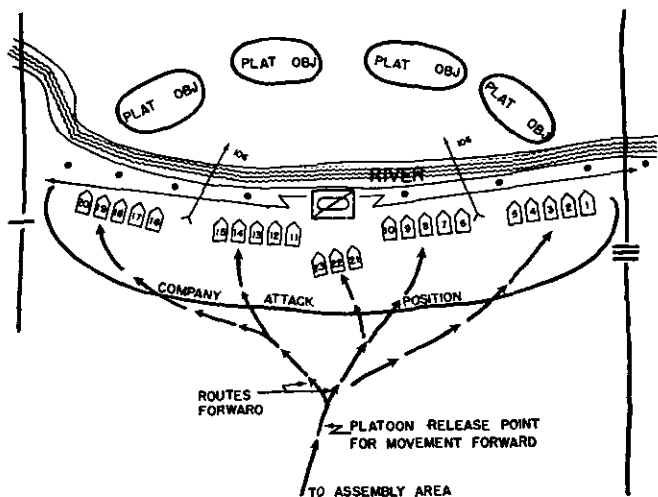
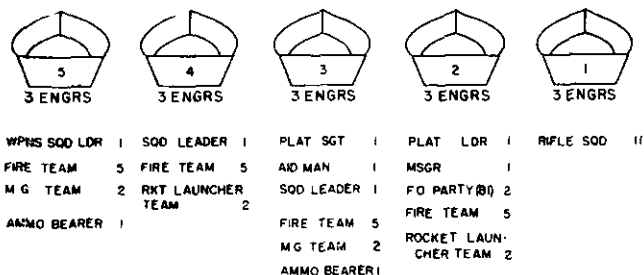

Figure 20. Assault river crossing using boats (schematic).

retained because of its inability to move to a critical area in time to influence the action early in the operation. Once the initial objective is seized, the company commander designates a reserve and selects a formation for continuation of the attack.

*g. Dispersion.* The massing of the company is carefully avoided to prevent offering a lucrative nuclear target. Consequently, the company usually crosses the river on a wide front, with considerable distance between platoons, initially. When physical contact with the enemy is gained, the likelihood of nuclear attack is reduced and a greater degree of concentration is acceptable.

## FIRST WAVE



*Figure 21. A type assault boat loading plan for a rifle platoon.*

*h. Assignment of Crossing Means.* The attacking company is normally allotted 23 assault boats to permit crossing the company without using any boat twice. In a typical crossing, the first wave consists of the rifle platoons, while the second wave consists of the company command group and the 81-mm mortar squads. The normal organization is 20 boats in the first wave (allowing 5 boats per platoon) and 3 boats in the second wave (fig. 20). Capacity of the current assault boat is 15 men, of which 3 are engineers who operate the boat. This capacity is reduced by the addition of heavy ammunition and equipment. In organizing rifle platoons into boat teams, the following principles apply: every effort is made to maintain tactical unity of the squads; both machineguns or both rocket launchers should not be placed in the same boat; and key leaders



## SECOND WAVE



COMPANY CMDR		WPNS PLAT LDR		EXEC OFFICER	
FIRST SERGEANT		MSGR		COMM CHIEF	
MSGR		RADIO TP OPR		WIREMAN	
RADIO TP OPR		MORTAR SQD	5	RADIO TP OPR	
MORTAR SQD	5	FD COMPUTER		ARMORER	
FD COMPUTER		WIREMAN		MORTAR SQD	5
				FD COMPUTER	

*Figure 22. Type loading plan for the second wave.*

of the platoon should not occupy the same boat. For type assault boat loading plans, see figures 21 and 22.

*i. Weapons Platoon.* The 81-mm mortar squads normally cross in the second wave and support the attack from positions on the far side of the river. They may be used to support the initial crossing from the near bank when other available fire support is inadequate. The anti-tank squads usually support the crossing from positions on the near side of the river and cross as soon as means become available. If helicopters are available, antitank squads may be lifted across the river early in the operation.

*j. Engineer Support.* Effective coordination with engineers supporting the company's crossing is essential at all times during the operation. In addition to placing boats in position, furnishing boat crews, and providing technical assistance, the engineers furnish guides to assist the boat teams in reaching the boats. Generally, a minimum of 1 guide is required for each platoon. The engineer crew of 3 men normally operates each assault boat, with 2 in the bow and 1 in the stern. The engineer in the stern steers and has technical command of the boat. The infantry boat team leader has tactical command of the boat and tells the engineer where the boat is to land. The engineer crew assists the boat team in embarking, paddling, and debarking. After the boat team debarks, the engineer crew returns the boat to the near bank.

*k. Communications.* During the early stages of a river crossing, radio is the principal means of communication, supplemented by visual signals and messengers. To provide telephone communication with battle group, two boats in the second wave normally lay wire lines across the river.

*l. Resupply.* After crossing, the only supplies immediately available to the attacking elements are those carried by the men. In addition to ammunition carried by individuals, each boat normally carries a selected load of critical items to be dropped on the far bank. Elements of the second wave consolidate ammunition dropped on the far bank and establish a company ammunition

distributing point. Individuals carry rations as required. Normal resupply is reestablished when means become available to cross preloaded vehicles. Helicopters may also be available for resupply.

*m. Rehearsal.* Whenever time, terrain, and equipment permit, full-scale rehearsals are conducted to closely simulate the actual crossing. If conditions do not permit a full-scale rehearsal, the company commander should request that assault boats be made available for dryland training. Such training should include designating paddlers and nonpaddlers, carrying the boats, launching, loading, paddling, and debarking. For additional discussion of attack planning, see paragraphs 49 through 58 and 65 through 71.

## **112. Conduct of the Crossing Using Boats**

*a.* Boat teams are organized and all plans and orders for the crossing are completed in the assembly area. Depending on the distance from the assembly area to the attack position, the initial movement may be made by vehicle. The order of march is designed to permit continuous movement into and out of the attack position. Movement from the assembly area to and across the river is made as rapidly and with as much secrecy as possible. When the company enters the attack position, engineer guides meet the platoons and guide them directly to their boats. If the timing of the movement has been correct, the boat teams halt no more than momentarily before

they pick up their boats and move to the water. On reaching the water's edge, boats are launched, loaded, and paddled across the river without a halt. No effort is made to counteract the drift of the current, nor do boats attempt to maintain alignment. Weapons are not fired from the boats. Every effort is made to cross the river rapidly. As the boat teams reach the far bank, they debark, fix bayonets, and move forward rapidly toward their initial objective.

b. Initially, the company commander remains on the near bank where he can best observe the action of the first wave in its crossing. As soon as the first wave has crossed, debarked, and cleared the far bank, he orders the second wave to cross. The second wave should land by the time the first wave has advanced far enough to provide space for the 81-mm mortars to go into position to support the attack.

c. The attacking platoons fight initially as boat teams. Squad and platoon leaders regroup their units while on the move and complete reorganization after the first objective has been seized. Mopping up on the far bank is carried on concurrently with the advance. Failure to reduce effective resistance can interfere with the crossing of subsequent waves and the operation of engineers at raft and bridge sites.

d. For additional discussion of the conduct of the attack on the far side of the river, see paragraphs 59 through 64.

## **Section XIII. TASK FORCE OPERATIONS**

### **113. General**

*a.* A task force is a temporary grouping of units under one commander designed to perform a specific mission or operation. Task force operations are normally independent or semi-independent for which the force commander receives a mission type order and acts independently to carry it out. This type operation usually implies the use of highly mobile forces having great firepower.

*b.* The strength of task forces may vary considerably, depending on the missions involved. This section is limited to a discussion of those task forces for which the company and platoon form the nucleus.

*c.* Task forces may perform a wide variety of missions involving attack, defense, and retrograde movements. Some appropriate missions are: locating nuclear targets; reconnaissance in force; seizing critical terrain, such as bridges, defiles, or communication centers; conducting raids; and exploiting a successful penetration of enemy defenses.

### **114. Task Force Organization**

*a.* In the organization, the task force commander is provided with the necessary means to accomplish his mission. The task force is tailored to fit the specific situation and mission at hand. In order to achieve economy of force and to facili-

tate speed and control, only those elements necessary to accomplish the mission are included.

b. In determining the organization, a commander considers especially the *mission, enemy situation, terrain and weather, and troops and fire support available* (METT).

- (1) *Mission*. Since a task force is organized to accomplish a specific mission, this is the dominant consideration in its organization. The strength, mobility, staying power, and ratio of maneuver elements to fire support elements should provide the optimum capability of accomplishing its mission.
- (2) *Enemy situation*. The combat effectiveness, mobility, firepower, and capabilities of enemy likely to be encountered are considered, and sufficient means to overcome the enemy are given to the task force. For example, an enemy strong in armor must be met with adequate antitank power.
- (3) *Terrain and weather*. The terrain over which the task force will operate influences the vehicles used, the ratio of men to weapons, and the types of weapons, units, and equipment to be included. Weather and visibility affect the use of aircraft and may limit the ability to observe and adjust artillery fires.
- (4) *Troops and fire support available*. Forces not available in the parent unit may be requested from higher head-

quarters. The commander considers the extent to which the formation of the task force will affect the mission of the parent unit. The indirect fire capability of the task force depends largely on whether or not it will be operating beyond supporting range of weapons which can furnish the required support.

*c.* A task force is usually composed essentially of a maneuver element, a direct fire support element, an indirect fire support element, a reconnaissance and security element, and a control element. Additionally, a support element with engineer, medical, supply, and maintenance capabilities may be included. A task force will normally be completely mobile, either by ground vehicle, by aircraft, or by a combination of these means.

*d.* Additional radio communications will frequently be required to augment organic equipment. Adequate means must be available to the commander to communicate with his parent organization and to provide adequate control within the task force.

*e.* The company normally organizes and arranges for equipping a task force having a rifle platoon as a nucleus, while the battle group organizes and arranges for equipping a task force having the company as a nucleus. The unit organizing the task force provides elements and equipment to the maximum extent possible, procuring additional elements and equipment from higher headquarters as necessary. For purposes

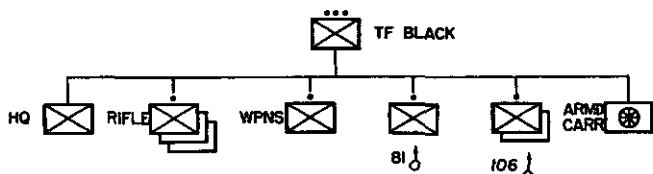

Figure 23. A type task force with a rifle platoon as a nucleus.

of control, elements are attached to, rather than placed in support of, the task force.

f. Numerous combinations of units and equipment can be assembled to organize a task force. Type task forces of various sizes to meet anticipated requirements should be established by unit standing operating procedure to facilitate rapid formation of units trained to work together. The combination of units depends upon the factors listed in *b* above. See figures 23 and 24 for examples of type task forces.

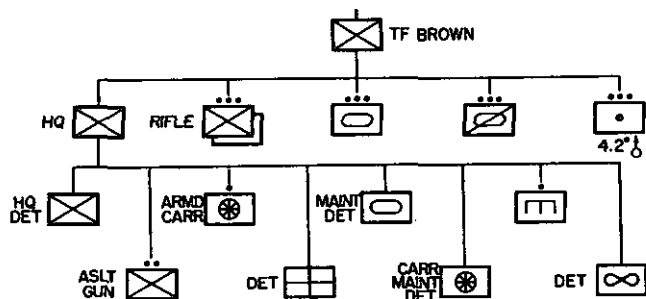

Figure 24. A type task force with a rifle company (minus) as nucleus.

Note. Additional vehicles for logistical support are included as needed.



## **115. Tactical Employment**

*a.* The tactics and techniques of offensive and defensive action and of tactical and retrograde movements covered in other portions of this manual are applicable to task force employment. The capabilities and limitations of the units that comprise a task force, the existing situation, and the assigned mission determine how the task force will be employed.

*b.* Plans for the operation are as detailed as time and available information permits. Because the enemy situation is frequently vague, the plan must be flexible enough to permit changes to meet unforeseen situations. During the conduct of the operation, orders are usually fragmentary, placing emphasis on battle drill type actions.

*c.* The task force commander initially disposes his elements in the formation in order of anticipated use. Tactical integrity is maintained when possible. Emphasis is placed on ground and air reconnaissance to the front, flanks, and rear to provide security. Since the guidance and support from higher headquarters will usually be limited or non-existent during the conduct of the operation, success will depend largely on the tactical skill, initiative, aggressiveness, and strong leadership of the task force commander and his subordinates.

*b.* The task force commander capitalizes on the mobility, firepower, and flexibility of his force. He attempts to defeat in detail by a series of quick, violent attacks, enemy elements which are

not mutually supporting. He attempts to gain advantage through rapid maneuver against the enemy flanks and rear. He utilizes offensive action to the maximum to destroy or disrupt the opposing force, even in defensive or retrograde operations. He avoids decisive engagement with superior forces and retains freedom of action, consistent with his assigned mission. Actions of the task force are characterized by rapidity of movement, aggressiveness, maximum use of maneuver, maximum use of offensive action, and teamwork.

*e.* Because of the independent nature of most task force operations, resupply and evacuation are frequently accomplished by air. To assist in rapid resupply, preplanned balanced loads of ammunition and other supplies are often prepared prior to the operation, based on anticipated needs.

## **116. Training**

Practice in the organization and employment of various type mobile task forces in training is imperative if good results are to be obtained in battle. Their composition should be established by unit standing operating procedures. Battle drills and other rehearsed maneuvers, directed by a brief prearranged message or codeword, are useful to accelerate combat action. The varied elements assembled in a task force must understand each other's capabilities and limitations and learn to work together with harmony and efficiency; this teamwork is essential and is obtained only through extensive training.

## Section XIV. RAIDS

### 117. General

*a.* A raid is a surprise attack upon an enemy force or installation, with the attacking forces withdrawing after accomplishing their mission. Raids are normally made by small forces such as a company or smaller unit and are usually ordered by the battle group commander.

*b.* A raiding force may be assigned such missions as destroying key installations, command posts, supply dumps, and nuclear delivery means; capturing prisoners or materiel; or harassing the enemy to disrupt his operations.

*c.* The success of a raid depends largely on achieving surprise. Consequently, raids will frequently be conducted at night and during adverse weather conditions, utilizing difficult terrain which may be considered impassable by the enemy.

*d.* The size of the raiding force is kept to the minimum which can reasonably be expected to accomplish the mission. The difficulty of achieving surprise and maintaining control increases in proportion to the size of the raiding force.

*e.* The use of air transport permits a raiding force to bypass enemy positions, terrain, or distance barriers which might preclude a raid by ground forces. In an airborne raid (parachute delivered or air-landed), forces are more apt to be operating beyond supporting distance from their parent unit than in other types of raids.

f. For additional discussion of raid patrols, see FM 21-75; for airborne raids, see FM 57-30 and FM 57-35.

## **118. Planning**

a. *General.* Thorough planning is essential to the successful execution of a raid. As much detailed advance information of the enemy is obtained as possible. If the raid is to be conducted at night, information of the enemy's night dispositions is generally obtained by patrolling. All activities in preparation for the raid are conducted in a manner which preserves secrecy.

b. *Organization.* The commander of the raiding force organizes his unit into an assault element and a security element. Each element is organized and equipped to accomplish a specific part of the overall mission. The assault element eliminates hostile resistance at the objective and performs specific combat tasks as required. The security element provides security and isolates the objective during the attack by the assault element. The size and composition of these elements depend upon the tasks to be accomplished and the expected resistance at the objective. The assault element may use special equipment such as demolitions and flamethrowers, and it may include special elements such as engineers.

c. *Route of Advance and Withdrawal.* Routes are selected to avoid known or suspected enemy positions. Covered and concealed routes of approach are used, and the raid is launched from the last concealed position. Advance and flank

security detachments may precede the raiding force and silently dispose of enemy security elements along the selected route to prevent premature discovery. Although the withdrawal may be conducted over the same route used for advance, alternate routes of withdrawal are selected and plans are made for their use. Provisions are made to keep withdrawal routes open by use of security elements or prearranged fires.

*d. Rallying Points.* A rallying point serves as a common location where units assemble which either have become separated during the raid or have completed their mission and are ready to withdraw. A rallying point is designated along the route of withdrawal. The rallying point should be easy to find, easy to defend for a short period, provide concealment, and offer cover from small-arms fire from the objective area.

*e. Fire Support Plan.* A complete and detailed fire support plan is prepared even though such fires might not be used. Fires in support of the raid are planned and executed as for any other attack. They will decrease the element of surprise, but the strength of the enemy position may require their use. Supporting fires are planned to isolate the objective, to prevent or limit hostile counterattacks, and to aid in keeping open the route of withdrawal.

*f. Security.* Security is maintained throughout the planning and conduct of the raid to deny the enemy knowledge of the exact location, direction, and objective of the raid. Feints may be planned by higher headquarters to increase the

chances of gaining surprise. During the raid, the raiding force commander protects his flanks by using flank security detachments and prearranged fires on probable avenues of enemy approach. Security elements are given definite instructions regarding their dispositions and the time or signal for withdrawal.

*g. Rehearsals.* When possible, rehearsals are conducted over terrain and light conditions similar to that which will be encountered on the raid. Rehearsals are repeated if necessary to insure that all members know the tasks which they are to perform.

*h. Airborne Raids.* In addition to the considerations listed in *a* through *g* above, the following aspects should be considered in planning an airborne raid (either parachute delivered or air-landed):

- (1) Plans for movement are designed to deliver the raiding force to the objective area intact with a *minimum* risk of detection. Routes are carefully selected to avoid enemy positions and to take advantage of defiladed routes of approach and withdrawal. Deceptive measures may be used.
- (2) Withdrawal of the force is normally difficult and requires detailed primary and alternate planning. If the mission of an air-landed raiding force can be accomplished in a relatively short period of time, it may be possible for the delivery aircraft to remain at the land-

ing area, covered by a security force, until withdrawal of the raiding force. If such action would unduly expose the aircraft, the raiding force may rendezvous with withdrawal aircraft at a pre-designated place and time.

- (3) Because this type force is capable of striking deep into enemy territory, support from other services may be required, necessitating thorough coordination. Work in conjunction with partisan or guerilla forces may also occur.
- (4) Planning and preparation for an airborne raid closely parallel that for the airborne assault (pars. 187-201). The plan of attack described for the airborne assault is modified to incorporate considerations appropriate to ground raids. For planning the withdrawal of the raiding force by air, see paragraphs 202 through 207.

### **119. Conduct**

*a.* During movement to the objective area, every effort is made to bypass enemy elements and escape detection. Security elements normally precede the main force and operate to its flanks. If a security detachment becomes engaged, the main force attempts to avoid the action so as to continue uninterrupted.

*b.* In the conduct of an airborne raid, elements of the raiding force normally assemble independently immediately upon landing, check with the force commander for any changes in plans, and

then proceed to carry out their assigned tasks without further assembly.

*c.* Upon arrival in the objective area, regardless of the type of raiding force, the security elements position themselves to block approaches and prevent enemy reinforcements from moving into the objective area. They also prevent enemy within the objective area from escaping. When the security elements are in position, the assault element attacks. The specific action of the assault element at the objective will vary depending upon its mission; however, in any case, it attempts to accomplish its mission in a minimum amount of time. Normally its attack is designed to be quick and violent so as to capitalize on the enemy's surprise.

*d.* Following the accomplishment of the mission at the objective, the force reassembles at the rallying point and withdraws. Security elements operate to the flanks and rear of the force to cover its withdrawal. Supporting fires are delivered as necessary to assist in breaking contact. Rapidity of movement is essential. Security elements operating to the front increase the chances of bypassing enemy positions during the withdrawal.

*e.* Casualties are assembled at specified points for evacuation. The commander does not divert any of his combat strength to evacuate casualties until the mission has been accomplished and the force is prepared to withdraw.

*f.* A portion of the raiding party may be as-



signed the mission of acting as a stay-behind force, to avoid having the withdrawal cut off by enemy action. For a discussion of the actions of such forces, see paragraph 170.

## CHAPTER 4

### DEFENSE

---

#### Section I. GENERAL

#### 120. Mission and Employment of the Company

*a.* The mission of the rifle company assigned to defend an area is to stop the enemy by fire in front of the battle area, repel his assault by close combat if he reaches it, and, within its capability, destroy and eject the enemy by counterattack if he penetrates the battle area. The rifle company defends as part of a larger force to deny a vital area to the enemy, to protect a flank, to gain time, to economize forces, or to effect maximum destruction and disorganization on the enemy.

*b.* The larger force of which the company is a part may be conducting a mobile defense, a position defense, the forward areas are strongly held. The mobile defense is a fluid defense in which the forward areas may be held lightly, with most of the defending force held as a striking force to defeat the enemy by offensive action. In the position defense, the forward areas are strongly held, with the aim of stopping the enemy forward of the battle area. In the mobile defense, the

company may be required to conduct a withdrawal and delaying action in addition to defending one or more areas (ch. 5). The company may also conduct offensive action as part of the reserve or striking force of a larger unit (ch. 3). For a discussion of the battle group in the mobile and position defense, see FM 7-40.

### **121. Concept of Defense**

The defense, regardless of type, consists of three echelons; the security echelon, forward forces, and the reserves. The security echelon provides early warning of the approach of the enemy, delays and disorganizes his advance, and deceives him as to the true location of the battle area. The forward forces engage the enemy in decisive combat, or stop, slow, canalize, or disorganize him to facilitate his destruction by other forces and means. The reserves are employed to limit penetrations, to protect the flanks and rear, and to destroy or eject the enemy by counter-attack.

### **122. Basic Considerations of Defense**

The commander organizes and conducts the defense through the application of basic considerations. These considerations cannot be applied equally in all situations, and their degree of application is modified as necessary. The commander decides which of the basic considerations must be emphasized in order to best accomplish the assigned mission.

*a. Proper Use of Terrain.* The defender takes maximum advantage of the terrain by placing

troops and weapons in positions which offer good observation, fields of fire, cover and concealment, and which block enemy avenues of approach to critical terrain.

*b. Security.* Provisions are made to offset the attacker's advantages of initiative and flexibility, and to force him to attack under unfavorable circumstances. Active and passive measures are utilized to protect the unit against observation or surprise from any direction.

*c. Mutual Support.* Mutual support is achieved by positioning units so they can reinforce one another by fire or movement. In situations where wide gaps exist between units, emphasis is placed on coordinated surveillance, timely exchange of information, and coordinated fires.

*d. All-Round Defense.* A defensive position is organized so that it can be defended from any direction. This is accomplished by the organization and preparation of primary and supplementary positions.

*e. Defense in Depth.* The attacker can penetrate a defensive position if he is willing to pay the price in lives and materiel. For this reason, units and weapons are placed in depth where penetrations can be canalized, stopped, and destroyed.

*f. Proper Use of Barriers.* Barrier planning includes considerations for the employment of a series of natural and artificial obstacles to canalize, divert, restrict, delay, or stop the movement of enemy forces. Careful consideration is given to freedom of maneuver for friendly forces.

Routes must be available for use by security elements during their withdrawal, by patrols, and by the maneuver element of counter-attacking forces. Barriers are of particular importance when defending on wide frontages.

*g. Coordinated Fire Plan.* The fires of infantry weapons, artillery and naval gunfire and the use of tactical air support are carefully planned and expressed in orders. Nonnuclear and nuclear fires are planned to complement and supplement each other. Fire planning is closely coordinated with the barrier plan. The coordinated fire plan provides for—

- (1) Bringing the enemy under fire as soon as he comes within effective range of appropriate weapons.
- (2) Holding him under increasingly heavier fire as he approaches the battle area.
- (3) Breaking up his assault by fires immediately in front of the battle area.
- (4) Destroying him within the battle area by a combination of fires and counter-attack.

*h. Flexibility.* A commander achieves flexibility by providing an adequate communication system, by withholding an adequate reserve to be employed in blocking or counterattacking enemy penetrations, and by centralizing control of his supporting fires, when practicable.

*i. Maximum Use of Offensive Action.* The spirit of the offensive must be maintained. Troops must be psychologically conditioned to

shift rapidly from the defense to the offense. In fluid situations involving wide frontages and great depths there will be many opportunities to regain the initiative by offensive action. Destruction of enemy forces by nuclear supported counterattacks will be a frequent occurrence.

*j. Maximum Dispersion Consistent With the Performance of the Mission.* The company commander is faced with the problem of weighing his vulnerability to nuclear attack because his unit is too concentrated, against the possibility of defeat in detail because his unit is too widely dispersed. He decides the degree of concentration that he can risk based on his mission and estimate of the enemy's nuclear weapons capability. If the company commander decides to employ a relatively concentrated type of defense, he must use every possible means to prevent the enemy from determining the disposition of his troops. In a dispersed formation, it is generally possible that units not engaged with the enemy may take more extensive protective measures. Also, the possibility of being defeated in detail in a dispersed formation presupposes that the enemy will have to concentrate or mass at least to a degree. This massing may be sufficient to make the enemy vulnerable to nuclear attack by the defending forces.

### **123. Definition of Terms**

*a.* The *battle area* is the area in which forward forces and their reserves are located. The *forward edge of the battle area* (FEBA) is de-

lineated by the forward edge of the forward rifle platoons, and it intersects boundaries at limiting points.

*b.* A *blocking position* is a position organized to deny the enemy access to a given area or to prevent further advance of the enemy in a given direction. A *switch position* is a position diagonal to and connecting successive defensive positions that are parallel to the front. Blocking and switch positions are normally designated in rear of the FEBA. They are organized similar to other defensive positions. A blocking position differs from a switch position primarily in orientation: a blocking position is normally oriented generally to the front, while a switch position is normally diagonal to the front.

## Section II. SECURITY FORCES

### 124. General

The following security missions may be assigned a rifle company:

- a.* Function as part of the general outpost.
- b.* Function as all or part of the reconnaissance and security line.
- c.* Establish and control all or a part of the combat outpost.
- d.* Establish the outpost for an assembly area of a larger unit.
- e.* Establish roadblocks and ambushes.
- f.* Defend rear installations.
- g.* Participate in operations against airborne attacks, guerillas, and infiltrators.

## **125. General Outpost Line (GOPL)**

*a.* The general outpost is a security echelon, normally provided by the division, which is located approximately 6,000–12,000 yards forward of the FEBA. It warns of the enemy approach and provides time for units to prepare the main battle area. The mission emphasizes locating nuclear targets, deceiving the enemy into presenting a nuclear target, or allowing some of its own elements to be bypassed to stay behind enemy lines to provide intelligence information and to control fires.

*b.* The company, as part of the battle group on the GOPL, is normally assigned a wide frontage and a delaying action mission. Platoon positions are selected to permit long-range fires and observation. Obstacles and demolitions are used extensively. Retention of a company reserve is frequently not possible. As part of the reserve for the general outpost, the rifle company may provide security elements forward of the GOPL.

## **126. Combat Outpost Line (COPL)**

*a.* The combat outpost is a security echelon, normally provided by the battle group, which is located approximately 1,000–2,500 yards forward of the battle area. The mission of the combat outpost is to provide early warning of the advance of the enemy and to deny him close ground observation of the battle area. Within its capabilities, it delays and disorganizes the enemy and deceives him as to the true location of the battle area. It avoids close combat.



b. The battle group commander usually prescribes the general location, control, and composition of the combat outpost. Normally, the forward companies provide the forces and are given the authority to control it. ~~Reinforcements~~, such as tanks, are frequently attached to the company for use on the combat outpost. Additional elements, such as reconnaissance elements, may also be attached. In some situations, all troops for use on the combat outpost may be attached to the forward company from the battle group reserve. The combat outpost in front of each forward company usually consists of a reinforced rifle platoon. Preferably, the platoon is mechanized. Artillery and mortar support is usually provided to the combat outpost from within the battle area. See FM 7-40.

c. The forces on the COPL are disposed laterally in one echelon in a series of outguards, varying in strength normally from a half-squad to a reinforced squad (fig. 25). These outguards are positioned near the topographical crest, preferably on terrain which affords long-range observation and fields of fire; however, it may be necessary to position an outguard on less desirable terrain to cover a specific approach into the battle area. Preferably, adjacent outguards are within visual distance of each other. At night, redistribution of forces and/or additional security measures may be required to insure accomplishment of the mission.

d. Forward observers are employed with the combat outpost. The outpost commander plans

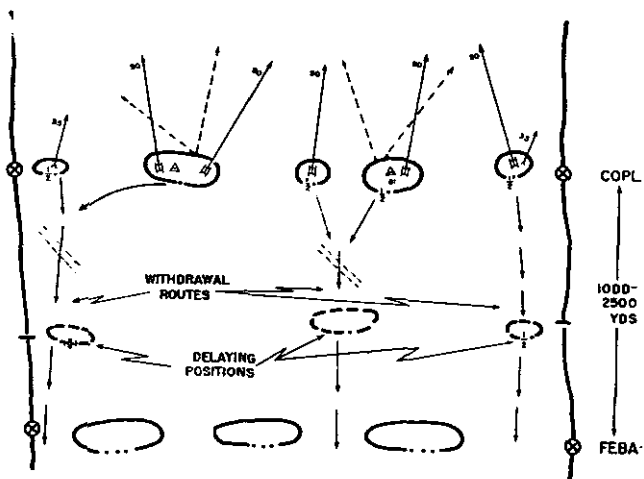

Figure 25. Type organization of combat outpost (schematic).

fires well forward, immediately in front of, within, and to the flanks and rear.

e. The outpost commander provides security through the use of sentinels, listening posts, warning devices, and patrols. When observation is limited, visiting patrols are used between widely separated outguards. Contact is from left to right. Following the withdrawal of, or in absence of the general outpost, long-range patrols forward of the combat outpost are used to gain and maintain contact with the enemy and to call for and adjust artillery and mortar fire. These patrols may be furnished by the combat outpost or by units (such as the reconnaissance platoon) of higher headquarters. Patrolling is normally intensified during periods of reduced visibility.

*f.* Plans are prepared for withdrawal of the combat outpost and are coordinated with elements along the FEBA. The plan of withdrawal normally provides for delaying the enemy forward of the FEBA from one or more successive positions. This delaying action is designed to maintain contact so that any enemy withdrawal indicating his use of nuclear weapons can be detected. Prepared obstacles are utilized to assist in the delay. Routes selected should permit withdrawal of forces without masking the fires of units along the FEBA. All personnel of the combat outpost are thoroughly familiarized with withdrawal plans.

*g.* As the enemy approaches the COPL, he is engaged by fires at long range. Patrols in contact with the enemy withdraw as required. Information of the enemy is continually reported to higher headquarters and fires are increased in intensity as he approaches.

*h.* The authority to withdraw the combat outpost is normally delegated to the company commander. Based on information received from the outpost commander, the company commander normally orders a withdrawal when the primary mission has been accomplished and before becoming closely engaged. The company commander informs the battle group and adjacent unit commanders of the contemplated time of withdrawal, of the actual withdrawal and its completion. If all communication between the combat outpost and the company commander is lost, the combat

outpost commander may order withdrawal to prevent its destruction if it has accomplished its mission. Under such circumstances, every effort is made to notify adjacent units on the COPL and the company commander.

*i.* For techniques of withdrawal and delaying action, see chapter 5. Elements of the combat outpost delay the enemy forward of the FEBA within their capability. Should the enemy withdraw from the attack, elements of the combat outpost reoccupy the COPL and maintain contact with the enemy by use of patrols. When enemy action forces withdrawal of the combat outpost through the FEBA, fires of weapons within the battle area cover the withdrawal. Troops attached to the company for use on the COPL are released from attachment when they pass through the FEBA.

## **127. Reconnaissance and Security Line (RSL)**

*a.* A reconnaissance and security line may be prescribed in lieu of a GOPL or both a GOPL and a COPL. It is generally located farther forward than the COPL. It may be as far as 4,000 yards forward of the FEBA. See FM 7-40.

*b.* When employed, R&S forces perform the mission presented for the general outpost and combat outpost, if a COPL is not established. R&S forces are disposed generally as for the COPL, manning a series of lateral outposts, roadblocks, observation posts, and reconnaissance detachments. The rifle company, or elements of

it, may be assigned missions on the RSL, normally under battle group control.

### **128. Assembly Area Outpost**

When a force occupies an unprotected assembly area, strong security measures are taken. Every unit, regardless of size, is responsible for its own security. This security normally is provided by patrols and outposts. When the unit is a battle group or larger, one or more companies may be detailed as the assembly area outpost with assigned sectors. The mission given these elements may require them to delay the enemy to permit deployment of the unit occupying the assembly area.

### **129. Security of Rear Installations**

A rifle company or smaller unit may be detailed to protect a rear installation against attack by airborne forces, guerillas, and infiltrators. Normally the unit can provide this protection by establishing an observation and warning system, preparing necessary defensive positions, and retaining the bulk of its strength in mobile reserve. The security detachments may vary in size from individual sentinels to reinforced squads. They may include sentinel posts, outguards, and foot or motorized patrols. These detachments suppress minor disturbances and alert the mobile reserve to more serious threats. The mobile reserve is prepared to attack the hostile force or to defend the installation from prepared defensive positions.

## **Section III. FORWARD RIFLE COMPANY— PLANNING AND ORGANIZATION OF DEFENSE**

### **130. General**

*a. Guidance.* In assigning the company its mission, the battle group commander furnishes such guidance as is necessary to insure that it organizes and conducts the defense in accordance with the overall defense plan. He specifies whether the company is to defend its assigned area, to defend initially and be prepared to withdraw to defensive positions in rear, or to fight a delaying action. If the mission of the company is to defend, the defense is organized as discussed in this chapter. If the company's initial mission is to delay, see chapter 5.

*b. Boundaries.* Company boundaries, which are extended forward and to rear of the FEBA, indicate the area of responsibility. If the combat outpost is to be the company's responsibility, the boundaries are extended forward of the COPL to the limit of effective ground observation; otherwise their forward extension does not include the COPL. A company rear boundary may be designated by the battle group commander to insure a clear delineation of the area of responsibility.

*c. Limiting Points.* These points, which are designated on boundaries, serve two primary purposes. They indicate the general trace of the FEBA and the COPL (if appropriate) and they designate a place on the ground where adjacent

commanders coordinate their defensive plans to insure mutual support. Commanders (or their representatives) coordinate at the limiting point and decide whether the limiting point should be covered by fire (direct or indirect), occupied by troops, or covered through the use of barriers and fires. Adjacent unit commanders who agree on the desirability for relocating a limiting point may recommend the change to the commander designating it. Minor adjustments, which are mutually acceptable to adjacent unit commanders, may be made provided the next higher headquarters is informed of the adjustment.

*d. Frontage.* As a general guide, a forward rifle company is capable of defending a frontage of up to approximately 2,400 yards. Under favorable terrain conditions, the company may defend a considerably greater frontage. If the frontage and the terrain require the use of four rifle platoons along the FEBA, the capability of the company is normally reduced to one of delay. The assignment of a frontage permitting the use of only two rifle platoons on the FEBA will not be normal. For further general guidance on company frontages, see figure 26.

*e. Depth.* While the depth of the company area will vary, it normally does not exceed 1,500 yards.

*f. Formulation of the Defense Plan.* The company commander develops his plan of defense based on his estimate of the situation (app. II). He determines the disposition of his platoons, use of supporting fires, and use of barriers con-

CLOSE TERRAIN	COMPANY FRONT	2	3	* 4
		PLATOONS FORWARD	PLATOONS FORWARD	PLATOONS FORWARD
	OCCUPIES	600 YDS	900 YDS	1200 YDS
	OCCUPIES & COVERS	1000 YDS	1500 YDS	2000 YDS
OPEN TERRAIN	COMPANY FRONT	2	3	* 4
		PLATOONS FORWARD	PLATOONS FORWARD	PLATOONS FORWARD
	OCCUPIES	900 YDS	1400 YDS	1800 YDS
	OCCUPIES & COVERS	1600 YDS	2400 YDS	3000 YDS

\*See text

Figure 26. Rifle company frontages (guide figures).

currently, as these elements are interdependent. He applies the basic considerations of defense (par. 122) so as to best accomplish the assigned mission under the existing conditions. His actions are as discussed in appendix III.

### 131. Assignment of Platoon Defense Areas

a. Normally the company organizes its defense on the forward slope. The situation may require the use of the reverse slope (pars. 151-153), or the occupation of a combination of forward and reverse slope areas.

b. In determining platoon defense areas, the company commander analyzes the terrain and assigns platoon areas which dominate avenues of approach and protect the critical terrain. He avoids dividing the responsibility for defending an avenue of approach between two platoons. He strives to assign to one platoon an approach including the terrain which dominates it. He considers the frontage which each platoon is capable of defending under existing terrain con-



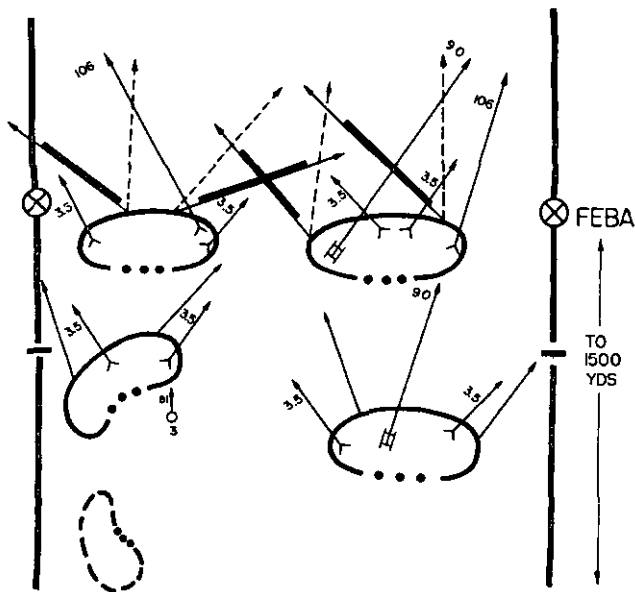

Figure 27. Company defense area, two platoons on FEBA (schematic).

ditions, visualizing how the platoon leader might employ his weapons and rifle squads. In selecting platoon areas for his forward platoons, he considers the desirability of retaining a company reserve to add depth to the defense area and flexibility in the conduct of the defense, consistent with requirements for providing adequate forces to defend the FEBA (figs. 27 and 28).

c. The reserve platoon(s) is normally positioned to provide depth to the company area, protecting the critical terrain in the company rear and/or controlling the most dangerous ap-



the flanks or to control other terrain or approaches which cannot be controlled from the primary position.

*d.* The company commander preferably assigns platoon areas by indicating, on the ground, to each platoon leader his area of responsibility, the general trace of the FEBA, and the points where platoon leaders will coordinate their fires. If time is limited, it may be necessary to specify this information by use of a map. Boundaries and limiting points are rarely designated between platoons.

*e.* Daylight dispositions may or may not be suitable for use in defense at night or other periods of reduced visibility. Gaps between forward platoons, which can be observed during daylight, may have to be occupied at night. In other situations, daylight dispositions may unnecessarily subject the company to defeat in detail at night, in which case platoons may be redispersed to form a more compact company defense. When such redispersion is contemplated, plans must insure adequate surveillance and fire coverage of the increased gaps on the flanks, and the plans must normally be approved by the battle group commander.

### **132. Coordinated Fire Plan**

*a. General.* The coordinated fire plan is designed to bring the enemy under fire as soon as he comes within air or ground observation (long-range fires); to hold him under an increasingly heavy volume of fire as he approaches the battle

area (close defensive fire); to stop his assault by an intense barrier of fire immediately in front of the battle area (final protective fires); to destroy him by fire if he penetrates the battle area; and to support counterattacks (fires within the battle area). It includes fires of organic, attached, and supporting weapons on targets of opportunity, and prearranged fires that can be delivered under any condition of visibility. The fire support plan is coordinated with the barrier plan to provide fire coverage of obstacles. For additional information on fire planning, see paragraphs 57 and 58.

*b. Barrages.*

- (1) Barrages fired by indirect fire weapons are part of final protective fires. A barrage is a prearranged barrier of fires designed to protect friendly troops by impeding enemy movements across defensive lines or areas. Barrages are coordinated with other direct and indirect fires and with artificial and natural obstacles. Normally barrages are planned to cover dangerous avenues of approach into the area to break up an enemy assault on friendly positions on the FEBA. They are usually planned so that the near edge of their effects is not more than 200 yards forward of the FEBA. Barrages take priority over all other fire missions. Artillery barrages are fired on order of the company commander in whose area they are located

and, when delivered, are fired continuously at maximum rate for a specified time or until ordered discontinued by the company commander. The firing of a barrage may be repeated on call if necessary. Only one barrage is assigned to a firing unit.

- (2) The widths of barrages of various weapons are contained below. These figures may be doubled when necessary; however, the effectiveness of fire will be decreased accordingly. A depth is not normally assigned to a barrage.

<i>Weapons unit</i>	<i>Width of barrage</i>
81-mm mortar squad .....	50 yds*
3 81-mm mortar squads .....	100 yds
4.2-inch mortar platoon .....	200 yds
105-mm howitzer battery .....	200 yds

\*This figure cannot be doubled.

- (3) The battle group commander designates the general location of the barrages of the mortar battery and of reinforcing artillery. The company commander in whose area the barrage is located directs its exact location to the artillery forward observer and reports the right and left limits of the barrage line to the battle group commander.
- (4) Based on recommendations of the weapons platoon leader, the company commander assigns each 81-mm mortar squad a barrage or assigns a barrage (100 yds) to be fired by all three squads

to cover foot approaches into the company area not covered by heavier barrages, or to add to the coverage of heavier barrages.

- (5) When a rectangle is used to depict a barrage graphically, the barrage line (center of impact) within that rectangle is the line joining the midpoints of the sides.

*c. Concentrations.* Concentrations for indirect fire weapons are planned to engage enemy targets throughout the company area of responsibility, both forward and in rear of the FEBA. Concentrations planned may include fires to support the combat outpost, cover avenues of approach, cover areas which direct fire weapons cannot reach, cover gaps between platoons, limit penetrations, support counterattacks, and cover other likely target areas.

*d. Antitank Defense.*

- (1) The company commander employs the antitank squads and attached tanks to cover likely armor approaches into the company area. The fires of these weapons are planned to engage enemy armor as soon as it comes within effective range. The location of these elements should provide antitank protection laterally and in depth. The antitank squads are normally positioned in the forward platoon areas to take maximum advantage of their range; however, one squad may be positioned in depth when other

antitank means are limited. Because of the number of tank approaches which usually will exist, the antitank squads are normally employed singly, each covering a separate approach. Alternate positions are selected for use when primary positions become untenable. Supplementary positions are selected to cover armor approaches not covered from primary or alternate positions.

- (2) Tanks may be employed in the company area under battle group control, in which case the antitank weapons under company control are positioned to complement their fires.
- (3) Rocket launchers in platoon headquarters are positioned by the platoon leader in coordination with other antitank weapons, to cover the most dangerous armor approaches into the platoon area. Rifle grenadiers provide antitank protection for the rifle squad.
- (4) Rocket launchers of company headquarters normally provide antitank protection for the company rear area as directed by the company commander.

*e. Small-Arms Fire.* In addition to providing small-arms coverage through assignment of platoon areas of responsibility, the company commander may specifically direct fire coverage of certain areas, such as gaps between platoons. He may require that these areas be covered by machinegun fire, or he may indicate the general

direction of a machinegun final protective line. Normally, however, the machineguns are employed by the rifle platoon leaders. Fires of the machineguns of attached personnel carriers supplement other fires. For a more detailed discussion of the utilization of fires of weapons organic to rifle platoons, see paragraph 138.

*f. Flame.* Portable or mechanized flame-throwers and flame field expedients may be used to provide close-in support.

*g. Disposition of Fire Support Plan.* The company fire support plan is forwarded to the battle group commander for integration into the battle group fire support plan. Subordinate leaders are informed of the fires available to them for the defense.

*h. Reference.* For a detailed discussion of the employment of the weapons platoon, see paragraph 140.

### **133. Coordinated Barrier Plan**

*a.* The coordinated barrier plan is generally originated by higher headquarters. It includes the use of obstacles and barriers to canalize, restrict, delay, or stop the ground movement of the enemy. The use of barriers and obstacles is coordinated closely with the fire plan, disposition of units, and plans for movement of friendly forces during the defense. Barriers and obstacles are planned forward of the FEBA to delay or canalize enemy movement, and within the battle area to limit penetrations; to provide a degree of



flank protection; or to canalize the enemy into areas favorable to the defender.

b. A barrier plan contains applicable portions of barrier plans of higher echelons. It also contains detailed instructions to subordinate units concerning the location and purpose of each barrier and the responsibility of subordinate units for the construction of specific obstacles that will make up the barrier.

c. Obstacles are most effective when covered by fire (FM 31-10). Care must be taken to provide sufficient gaps and lanes in the barrier system to permit movement of friendly forces for patrolling and counterattacking.

d. An obstacle, either natural or artificial, should be exploited to its maximum extent in the organization of an area for defense. Artificial obstacles are used to extend or supplement natural obstacles if possible. The battle group or higher headquarters generally coordinates the use of extensive obstacles, such as antitank ditches and minefields.

e. Barbed wire entanglements are classified as tactical, protective, and supplementary, depending on their use. *Tactical wire* entanglements are designed to break up attack formations and to hold the enemy in areas covered by the most intense defensive fires. Tactical wire entanglements are normally sited along the friendly side of machinegun final protective lines. These entanglements may extend across the entire front of a position but are not necessarily continuous. *Protective wire* is located to prevent surprise as-

saults from points close to the defensive positions. These entanglements are close enough for day and night observation and far enough away to keep the enemy beyond normal hand grenade range. *Supplementary wire* is used primarily to break up the pattern of tactical wire, thus deceiving the enemy as to the location of final protective fires. It is also used to connect platoon and company defensive areas and to canalize the enemy into areas of intensive fires.

f. The company commander may be authorized by the battle group commander to lay protective minefields, consisting of antipersonnel and anti-tank mines laid across likely avenues of approach within the company area of responsibility. These provide local protection against infiltration and small unit armored or infantry attacks. Mines are laid in standard or nonstandard patterns and are covered by fire. Antipersonnel mines are placed far enough from the position to keep the enemy out of hand grenade range. Mines may either be buried or concealed on top of the ground. They are placed so they can be rapidly removed by the installing unit. Standard or improvised trip flares or other warning devices may be used to give warning of enemy approach. The company commander is responsible for the laying, marking, recording, and reporting of the mines; for removing or transferring the minefield, when necessary; and for coordinating with friendly troops who may enter or pass through minefields in his area (FM 20-32).

g. The use of chemical and radiological contamination as part of the barrier plan will normally be directed and coordinated by a higher headquarters. The company may be required to cover such areas by fire.

### **134. Employment of Organic Weapons and Attachments**

#### *a. 81-mm Mortar Squads.*

- (1) Whenever possible, the 81-mm mortars are employed in general support in order to provide flexibility in the massing and shifting of fires, ease of control, and ease of ammunition resupply. The mortars are normally employed in general support when, from one or more position areas, the mortars can support all forward rifle platoons. Exceptionally, the forward platoons may be so widely separated that adequate fire support cannot be provided from the mortars while in general support role, in which case one or more squads may be attached to forward platoons, with the remainder being retained in general support.
- (2) When the company is responsible for the COPL, the mortars may frequently be positioned well forward initially, a short distance in rear of the FEBA, in order to provide adequate support for the combat outpost. Where such positioning will not provide adequate sup-

port, one or more squads may be attached to the combat outpost until withdrawal of the outpost.

- (3) When the mortars are employed in general support, the company commander designates a general position area, based on the recommendation of the weapons platoon leader.

*b. Antitank Squads.*

- (1) Whenever possible, the antitank squads are employed in general support, to permit flexibility in the movement of the weapons throughout the company area to meet armor threats as required. When the terrain in the area will not permit such movement, one or both squads may be attached to rifle platoons. See paragraph 132.
- (2) One or both squads may be attached to the combat outpost initially if other antitank means (such as tanks) are not available. If tanks are attached to the combat outpost, the antitank squads normally remain within the battle area.
- (3) When the antitank squads are employed in general support, the company commander assigns each a general position area and a principal direction of fire, based on the recommendation of the weapons platoon leader.

*c. Tanks.* Tanks, including mechanized flamethrowers, may be attached to the forward company. Attached tanks are normally retained in

general support to permit flexibility in their employment during the conduct of the defense. When the terrain will not permit rapid movement of tanks throughout the company area, all or a portion of the tanks may be further attached to rifle platoons. When the tanks are employed in general support, the company commander assigns each a general position area and principal direction of fire, based on the recommendation of the tank unit leader. See paragraph 132.

*d. Reconnaissance Elements.* Infrequently, reconnaissance elements may be attached to the company to facilitate accomplishment of the mission when assigned an extremely wide front. These reconnaissance elements are normally retained under company control and are most frequently assigned the mission of defending or screening a portion of the FEBA or of screening an exposed flank.

*e. Armored Carriers.*

- (1) When movement of the company is anticipated, as when the company mission calls for a withdrawal and delaying action to subsequent defensive positions, sufficient carriers may be attached to mechanize the entire company. In this case, the company commander normally further attaches them to his platoons, to include the weapons platoon if possible.
- (2) If only enough carriers are attached to mount a portion of the company, the company commander must decide to

which elements to furnish this additional mobility in order to best accomplish the company mission. Normally, carriers are attached to the combat output until their withdrawal. Thereafter, carriers may be attached to the reserve to facilitate its rapid movement to supplementary positions or in performing rear area surveillance, retained under company control to be employed as dictated by the situation, or attached to forward platoons when movement of these platoons is anticipated. In making his decision on their employment, the company commander considers the mission, plan for conduct of the defense, terrain in the area of operations, CBR contamination to be crossed, enemy mobility and armor capability, enemy air capability, the number of carriers attached, and security requirements. In any event, the decision on the use of the carriers is based on the mobility which they afford and *not* on the additional fires which their machineguns can provide.

- (3) For a discussion of positioning carriers attached to a platoon, see paragraph 138.

### **135. Surveillance and Security**

a. The company commander establishes a surveillance system for maintaining a constant watch, day and night, over the company area of

**responsibility.** This system affords security by **providing** early warning of the enemy approach and detecting enemy infiltration and activity in the company rear area. The surveillance system includes the use of sentinels and listening posts, observation posts, patrols, CBR detection devices, electronic surveillance devices, infrared or other night vision devices, trip flares and antipersonnel mines, noise-making devices, and any other means which may be made available to the company.

*b.* Normally the company commander prescribes the establishment of one or more listening posts (at night) or sentinel posts (during daylight) by each forward platoon. These security posts are usually positioned no more than about 400 yards forward of the FEBA so as to be within supporting range of small arms. Similar security posts are established in the rear area, normally by the company reserve, and in the gaps between forward platoons. These security posts normally consist of two or more men and may be equipped with appropriate surveillance devices.

*c.* Patrols are used forward of the FEBA, between forward platoons, and in the company rear area primarily to cover areas not under surveillance of the security posts or other surveillance means. Patrols normally operate at irregular intervals over a variety of routes to avoid establishing a pattern of operation.

*d.* An adequate communication system is essential to the functioning of the surveillance system. It may be necessary to utilize visual signals

extensively to augment other means of communication.

### **136. Organization of Ground**

*a.* The company commander may specify the sequence in which defensive positions will be prepared and any special precautions which will be taken regarding camouflage. While much of the work will be carried on concurrently, special emphasis may be required on certain aspects of the preparation of the position. A recommended sequence is as follows:

- (1) Establishing security.
- (2) Positioning weapons.
- (3) Preparing weapons emplacements and individual positions, to include overhead cover. Camouflage is accomplished concurrently.
- (4) Clearing fields of fire, removing objects masking observation, and determining ranges to probable target locations.
- (5) Providing signal communication and observation systems.
- (6) Preparing alternate and supplementary positions.
- (7) Laying minefields and preparing important demolitions.
- (8) Preparing obstacles (other than minefields) and less vital demolitions.
- (9) Preparing CBR protective shelters as required.
- (10) Preparing routes for movement and for supply and evacuation.



(11) Preparing deceptive installations in accordance with deception plans of higher headquarters.

b. The organization of ground begins as soon as the troops arrive in the area and continues as long as the position is occupied. The position may have to be organized while in close contact with the enemy, in which case defense against attack may be required during any or all stages of the organization. Maximum use is made of available fires to cover the organization, and smoke may be used to deny the enemy observation of the preparation.

### **137. Counterattack Planning**

a. The forward company normally has a very limited counterattack capability and for this reason will usually block to limit a penetration rather than attempt to eject or destroy the enemy by counterattack. However, the company commander will plan counterattacks within the company's capability. The company has no counterattack capability if all rifle platoons are employed on the FEBA.

b. A counterattack is a limited objective attack designed to destroy or eject the enemy from an area of penetration and to regain lost portions of the battle area. In his planning, the company commander assumes likely penetrations of the FEBA and plans a counterattack to reduce each. The assumed penetrations include critical terrain or threatened critical terrain and are of such size that they could be contained by the forward pla-

toons or by a portion of the reserve. Such assumptions are necessary, as these conditions must exist to permit or justify a counterattack at company level.

c. Each counterattack plan is developed generally like any plan of attack, as discussed in chapter 3. The maneuver element is normally the reserve platoon(s) and any attached tanks which might be disengaged and used as a part of the maneuver element. The plan consists essentially of a route to the LD, an LD, a direction of attack, an objective, and a fire support plan. The LD selected during the planning phase is normally along the line of contact for the assumed penetration. The attack is preferably directed at the flank of the penetration, with the movement of the maneuver elements avoiding friendly positions, if possible, but are planned and executed to take full advantage of all fires available from within these positions.

d. All subordinates are informed of counterattack plans. Leaders make necessary reconnaissance, and plans are rehearsed if time permits.

### **138. Organization of a Forward Platoon Defense Area**

a. *General.* The company commander assigns the forward rifle platoon an area to organize and defend. The platoon may not physically occupy all of its assigned area but will organize the best defensive terrain within it and cover the unoccupied portion by fire. The forward platoon area is organized for all-round defense and to provide

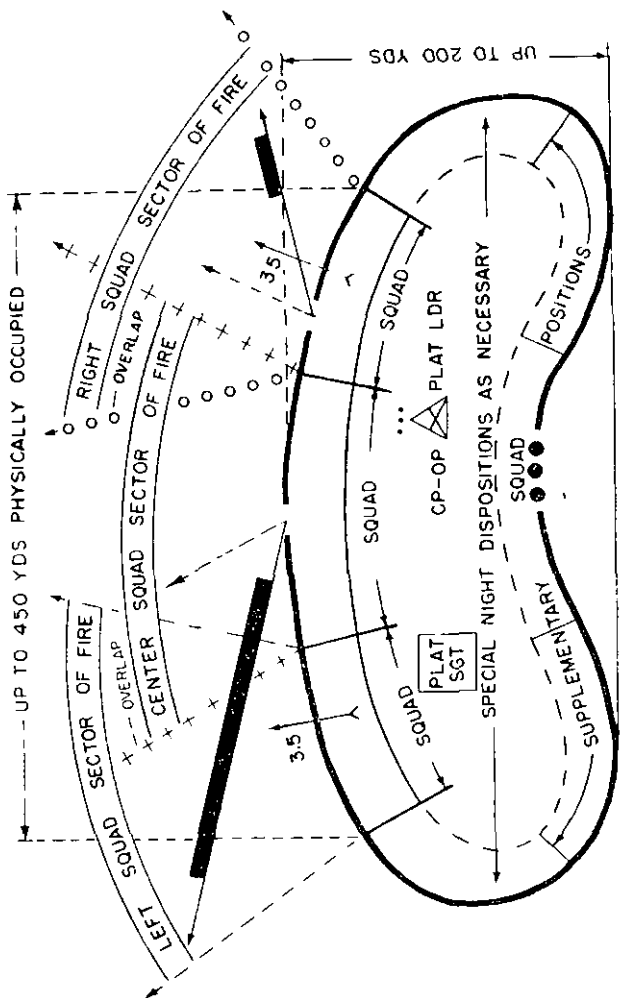

Figure 29. Typical disposition of a forward rifle platoon (schematic).

mutual support with adjacent platoons. The frontage which a platoon is capable of physically occupying is determined primarily by the mission, enemy, terrain, strength of the platoon, and the number of nonorganic weapons (such as tanks and antitank weapons) located in the platoon area. As a guide, the area physically occupied by a platoon (including its organic weapons) does not normally exceed about 450 yards in width. Based upon the considerations listed above, this figure may be considerably less. The platoon can defend an area up to about 800 yards in width, covering unoccupied areas by fire. The depth of a forward platoon area is determined by the distance between the primary and supplementary positions and may vary up to about 200 yards (fig. 29).

*b. Actions of Leaders.*

- (1) Upon receipt of the company order, the action of the platoon leader is generally as outlined in appendix III. He reconnoiters his assigned area, coordinates with adjacent platoon leaders and with leaders of supporting weapons located in the platoon area to insure mutual support, and formulates his plan. He is normally accompanied on his reconnaissance by the weapons squad leader, who makes recommendations concerning the use of his weapons. As soon as possible, the platoon leader issues his defense order, preferably pointing out on the ground the squad areas, weapons

positions, sectors of fire, and other appropriate information. When necessary because of enemy action, he issues his order in a covered position using maps, sketches or an improvised sand table. A fragmentary order may be issued initially so as to get the troops into the area to prepare the position as soon as possible, with the complete order being issued later.

- (2) Upon receipt of the platoon defense order, rifle squad leaders reconnoiter their assigned areas, coordinate with leaders of adjacent squads and of supporting weapons in their areas, and formulate their plans. See appendix III. They select firing positions for each rifleman and automatic rifleman, assisted by the fire team leaders, if appropriate. A sector of fire is selected for each rifleman, and a sector of fire and principle direction of fire is selected for each automatic rifleman. Each rifle squad leader selects a position for his own foxhole from which he can best control his squad and observe the platoon leader or his representative for signals.
- (3) The weapons squad leader selects the exact firing positions for his weapons, based on guidance from the platoon leader, and coordinates with the rifle squad leaders to avoid conflict in posi-

tioning of weapons. He selects positions for the ammunition bearers where they can provide a continuous supply of ammunition to, and protection for the weapons, and replace either individual on the weapon if one becomes a casualty. The squad leader selects a position for his own foxhole from which he can best control the teams of his squad and observe the platoon leader (or platoon sergeant) for signals. When this cannot be done from one position, the position selected should permit control over the weapons covering the most dangerous approaches. Other teams are controlled by the gunners or rifle squad leaders, as the platoon leader directs. The platoon leader may direct the weapons squad leader to be at the platoon CP-OP.

- (4) Complete squad orders are normally issued to the squad, a few men at a time, after they have begun to prepare the position.

*c. Rifle Squad Defense Areas.*

- (1) The three rifle squads are located so as to take maximum advantage of the terrain and the characteristics of the squad weapons. Where maximum frontage is to be covered, terrain permits, and depth of the area is not a primary consideration, the three squads are located abreast in an irregular line.

Where depth of the area is a primary consideration, terrain permits, and maximum frontages are not assigned, one squad may be positioned to the rear. Gaps are not normally planned between squads. However, when there are two significant terrain features within the area, a squad can be located on each and the gap between covered by fire. The squads are placed to deliver their heaviest volume of fire forward of the battle area. When gaps exist between platoons, the flanks of the platoon are refused (bent back toward the rear) to cover the gaps and to facilitate mutual support between units. The rifle squads prepare and occupy primary positions, usually on the forward slope of the terrain feature being organized, except in reverse slope defense (fig. 30).

- (2) The width of the area to be physically occupied by the squad is affected by the mission, enemy situation, terrain, strength of the squad, the density of fire needed, and the capability of the squad leader to control the squad. This area approximates 100 yards in width in open terrain. This distance is increased when nonorganic weapons are employed along the FEBA within the squad area. In close terrain, this figure is much less than 100 yards. The interval between foxholes varies with the

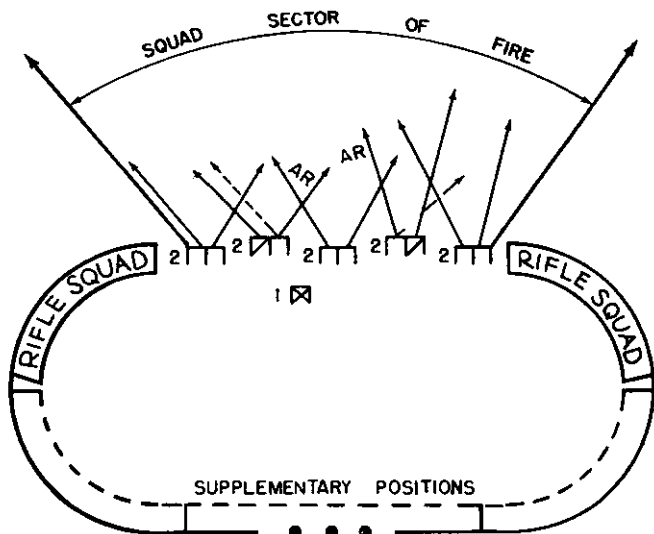

1 ☒ SQUAD LEADER IN ONE-MAN FOXHOLE

1 ▤ FIRE TEAM LEADER

2 ☐ TWO RIFLEMEN IN TWO-MAN FOXHOLE

Figure 30. Employment of a rifle squad in defense (schematic).

terrain and the use of single or double foxholes. As a guide, this distance may be from about 5 to 20 yards. In close terrain, the interval may be 5 yards between single foxholes and 10 yards between double foxholes. In open terrain, single foxholes may be about 10 yards apart and double foxholes 20 yards



apart. The choice between single and double foxholes is also influenced by such factors as morale, fields of fire, and unit strength. Because the double foxhole provides continuous observation and improves individual morale, it is used whenever conditions permit.

- (3) Within each squad, fire team integrity is usually maintained, with each fire team occupying about half of the assigned squad area. Fire team leaders are located in the line of riflemen, generally in the center of their fire teams, where they can best assist the squad leader in control.
- (4) Supplementary squad positions are selected to provide all-round defense of the platoon area. These positions are normally located not more than 200 yards from the primary position. Supplementary positions may not be necessary if the terrain permits the platoon to protect its flanks and rear from its primary position.

*d. Coordinated Fire Plan.*

- (1) The platoon leader, in preparing his fire support plan, familiarizes himself with the company coordinated fire plan as it affects the defense of his area. He uses a map or overlay, or makes a sketch showing the location and designated numbers of artillery and mortar concentrations and barrages in his area.

Normally an 81-mm mortar forward observer operates in the platoon area and is available to assist the platoon leader in planning and calling for fires. When time and facilities permit, he issues maps, overlays, or sketches to his subordinate leaders. The platoon leader coordinates the fires of the rifle squads and organic and attached weapons with the company fire support plan to provide for maximum defense of the platoon area.

- (2) The forward rifle platoon distributes its fire to cover its front and flanks and facilitate mutual support with adjacent platoons. Each rifle squad is assigned a sector of fire. These sectors of fire overlap to insure complete coverage of the platoon frontage and, when possible, extend to the front of adjacent units. The platoon leader may assign certain automatic rifles firing positions to exchange fires with adjacent units and to supplement the employment of the machineguns.
- (3) The platoon machineguns are normally positioned on the FEBA to cover the most dangerous foot approaches into the platoon area or to comply with general instructions from the company commander, such as covering the gaps between platoons or providing mutual support with an adjacent platoon. While

it is desirable to employ the machineguns in pairs to insure continuity of fire, the frontage assigned and the number of foot approaches into the platoon area will frequently require them to be employed singly. The platoon leader selects general position areas for the machineguns and assigns each a sector of fire and a final protective line. If the terrain will not permit the use of a final protective line, the platoon leader may assign a principal direction of fire and a sector of fire, or a sector of fire only. Alternate and supplementary positions are selected.

- (4) The platoon rocket launchers provide close-in antitank protection for the platoon area. They are located within the platoon defense area to cover the most dangerous armor approaches. The platoon leader selects a general position area and principal direction of fire for each rocket launcher. Alternate and supplementary positions are selected. Their location and principal direction of fire are coordinated with other anti-tank weapons located within the platoon area. As a secondary mission, the rocket launchers may be employed against enemy crew-served weapons and grouped personnel.
- (5) The squad leader selects a firing position and sector of fire for each rifleman,

taking advantage of the best fields of fire. Sectors of fire should be overlapping to insure complete coverage of the squad front. The squad leader selects a sector of fire and a principal direction of fire for automatic riflemen, if specific missions for these weapons have not been assigned by the platoon leader. The automatic rifles are normally positioned to cover dangerous approaches into the squad area. It is desirable that the automatic rifles be able to cover the entire squad area if possible. Rifle grenadiers provide close-in antitank protection for the squad and a means for covering areas not provided by direct fire weapons.

- (6) Fire control measures are included in the platoon leader's defense plan. These measures normally include the designation of terrain features where the enemy must pass before the platoon opens fire, and signals for final protective fires.
- (7) The fires of weapons must be coordinated with the use of mines, wire, flares, and field expedients. Antipersonnel mines and trip flares are placed in and near tactical wire in front of the defense area. The use of field expedients such as fougasse, noise making devices, and antipersonnel mines will add materially to the effectiveness of the fire plan.
- (8) Authority to call for final protective

fires is a part of the battle group coordinated fire plan. This authority normally is delegated down to the forward rifle platoon leaders to insure that these fires are delivered when needed.

*e. Utilizations of Attached Armored Carriers.*

Personnel carriers are normally attached to a forward platoon only when movement of that platoon is anticipated during the conduct of the defense (par. 134). When attached to the platoon, the carriers (normally 4) may be placed in hull defilade firing positions to support the platoon by fire; they may be positioned to provide security to the flanks and rear of the platoon; or they may be held in a covered and concealed position in rear of the platoon area. In determining the positioning of the carriers, the platoon leader must bear in mind that their primary purpose is to provide armor protected mobility. The carriers should not be placed in firing positions if such positioning will unduly expose them to antitank fires or enemy air attack.

- (1) If placed in firing positions, the carriers should be in hull defilade so that only the vehicular mounted machinegun is visible from the front. The platoon leader assigns a sector of fire to each weapon to supplement other fires. The carrier driver normally fires the machinegun. If the carriers are positioned to cover the flanks and rear, available cover is utilized to the maximum extent possible.

Alternate and supplementary positions and routes thereto are also selected.

- (2) If located in a covered and concealed area in rear, this area should be close to the platoon area (normally the first suitable area in rear of the platoon position). Vehicles are dispersed and positioned to provide all-around security. Additional security from the platoon is not normally provided.
- (3) In all positions vehicles are camouflaged as soon as possible. Measures are taken to obliterate track marks made by the vehicles moving into position, unless numerous track marks already exist in the area. Time permitting, the carriers may be dug-in or protected with sand bags, though not to the extent that would prevent them from moving quickly.
- (4) At night the carriers may be moved from rear areas to the platoon area for purposes of security to provide additional fires.

*f. Command and Observation Post (CP-OP).*

The platoon leader selects a combined CP-OP where he can observe to the front and flanks of his area and control his platoon. Preferably the platoon observation post has cover for all personnel and access to concealed routes to the company command post. The platoon sergeant is located where he can best assist the platoon leader in control. When located away from the observation post, he watches the platoon leader for commands,

and controls the part of the platoon most difficult for the platoon leader to control from his own location.

*g. Security.*

- (1) The platoon provides its own security by constant observation to the front, flanks, and rear. Sufficient men are kept alert to maintain an effective warning system. During the preparation of the area, a minimum of one sentinel is posted in each squad area to give warning of hostile ground, air, or CBR attack, and a skeleton crew is maintained on each crew-served weapon in the platoon area. Additional sentinels are posted forward and to the flanks and rear as required.
- (2) At night and during other periods of limited visibility, additional security measures are necessary. Listening posts and patrols, coordinated by the company commander, are employed in the area forward of the battle area, in the gaps between forward platoons, and to the rear of the platoon area. Although certain measures may be prescribed by the company commander, the platoon leader prescribes such additional measures as are necessary for the security of his platoon. The use of mines, wire, flares, and field expedients provide added security. At night, the percentage of individuals kept on an alert varies with

the fighting characteristics and proximity of the enemy. When the enemy normally attacks at night, and is in close proximity, the entire platoon may be kept on the alert. When security echelons such as a combat outpost line and other security measures are in effect to the front, as few as two men on alert in each squad area prove to be sufficient.

- (3) Sentinels and listening posts should be relieved often enough to keep them alert (normally about every 2 hours).

*h. Control and Communication.*

- (1) The platoon headquarters has a telephone which normally is in the company wire net, and a radio in the company radio net. The messenger may be used for communication with the company commander or with the squad leaders. In addition, the platoon leader may use the communication facilities of any forward observer or supporting units located in his area, as well as pyrotechnic signals.
- (2) For communication within the platoon, the platoon leader uses all means available including voice, messenger, arm and hand signals, and prearranged signals. When more positive control is necessary, the platoon leader moves, as needed, to achieve direct control.
- (3) The squad leader controls his squad



primarily through the fire team leaders by oral and visual signals and by personal contact. It is imperative that the squad leader anticipate difficulties in control and improvise expedients, such as having information and orders passed from foxhole to foxhole.

- (4) Additional telephones may be furnished to the platoon for use on a listening post.

*i. Organization of the Position.*

- (1) Upon arrival of the platoon, squad leaders move their squads to their areas immediately. The sequence of work is specified in the order (par. 136). Security is posted; crew-served weapons are set up; and positions, sectors of fire, and principal directions of fire (if appropriate) are specified to each individual. The squad leader has each man lie down at the place his foxhole will be dug to verify the observation and sector of fire permitted by his position. Fire team leaders assist the squad leader, as directed, in the organization and preparation of the position.
- (2) During preparation, all leaders supervise the actions of the men closely. Noise and light discipline are enforced, and movement is held to a minimum. Camouflage is accomplished concurrently with the preparation of the positions (FM 21-75). Range cards are prepared and checked. Leaders verify

sectors of fire and as appropriate, final protective lines and principal directions of fire to insure adequate fire coverage. Adjustments are made to correct any deficiencies noted. Individuals are questioned to insure that orders have been thoroughly disseminated and are understood.

- (3) Preparation of the area is continuous. Improvements are made to strengthen the defensive position as long as it is occupied.

### **139. Reserve Rifle Platoon**

*a.* The reserve platoon(s) is normally positioned in rear of the forward platoons to provide depth to the company defense area (par. 131). Through the use of the reserve, the company commander is able to influence the action of the company, thereby adding flexibility to the defense.

*b.* The company commander assigns the reserve platoon(s) a primary position(s) and one or more supplementary positions. He specifies the order in which the supplementary positions will be prepared. He further assigns the reserve one or more missions and states the priority of accomplishing each. Appropriate missions for the reserve are to—

- (1) Limit penetrations.
- (2) Protect the company flanks and rear.
- (3) Support the forward platoons by fire.
- (4) Perform surveillance in the company rear area and provide security.
- (5) Participate in a counterattack.

c. If the company is responsible for furnishing troops for the COPL, the reserve platoon is normally assigned this mission. Such a selection is desirable because it facilitates the preparation of forward platoon positions and permits the withdrawing combat outpost to pass through units in position on the FEBA. While the platoon is on the COPL, the company commander has other elements of the company prepare reserve platoon positions if at all possible. For a discussion of the combat outpost, see paragraph 126.

d. The organization of a reserve platoon position is generally the same as for a forward rifle platoon (par. 138), except that final protective lines are not selected. The entire platoon will normally occupy its primary position. However, when terrain conditions make movement of the reserve to supplementary positions difficult, it may be necessary for the platoon to organize and occupy more than one area initially. The integrity of the rifle squads is maintained in this situation, though the weapons squad may be divided.

e. The reserve platoon accomplishes assigned missions of limiting penetrations, protecting the company flanks and rear, and supporting the forward platoons by fire from prepared positions (either primary or supplementary) in the company rear area. These positions are normally located on or near critical terrain in the rear area. The position to be occupied by the platoon is designated by the company commander. He may order the platoon to move from one position to

another as required by the enemy situation. If assigned the mission of supporting the forward platoons by fire, the reserve may fire into the gaps between platoons and at any enemy attempting to attack the forward platoons from the rear. The location of the reserve to accomplish missions of higher priority may frequently limit the amount of effective fire support which it can furnish to the forward platoons.

*f.* Specific security and surveillance responsibilities of the reserve will normally be stated in detail by the company commander. The reserve may be required to establish sentinel or listening posts forward of, in rear of, and in the gaps between forward platoons. It may be required to patrol throughout the company area and to maintain contact with adjacent units. For additional discussion of security and surveillance, see paragraphs 135 and 138.

*g.* The situations when the reserve will participate as the maneuver element in a counterattack are rare. However, the reserve platoon leader, when assigned such a mission, prepares plans for his platoon to implement company counterattack plans. In addition, he may assist the company commander in preparing the company plans as directed. Plans for a counterattack are essentially the same as for any attack (par. 137 and ch. 3). All leaders of the reserve are thoroughly oriented on counterattack plans, and these plans are rehearsed if time permits. For conduct of the counterattack, see paragraphs 143 through 146.

## 140. Weapons Platoon

a. *Missions and Employment.* The primary mission of the antitank squads in defense is to provide antitank protection for the company. The squads have a secondary mission of reinforcing the fires of the other weapons located on the FEBA. The mission of the 81-mm mortar squads in the defense is to provide close and continuous fires to the company. The mortar squads accomplish this mission by: firing concentrations in support of the combat outpost (if appropriate); firing concentrations both forward of and in rear of the FEBA; and firing barrages. For the employment of the antitank and mortar squads, see paragraphs 132 and 134.

b. *Actions of the Platoon Leader.* The weapons platoon leader normally accompanies the company commander to receive the battle group defense order. He may accompany the company commander on his reconnaissance, or he may make a separate reconnaissance. The platoon leader prepares recommendations on the employment of the platoon (pars. 132 and 134). If general support appears to be feasible, he also prepares recommendations on: general position areas, to include alternate and supplementary positions; disposition of forward observers; principal direction of fire for each antitank squad; and locations of 81-mm barrages and concentrations. For a discussion of the actions of the platoon leader in preparing for the defense, see appendix III.

c. *Mortar Fire Planning.* As soon as possible,

the platoon leader coordinates with the artillery FO and, assisted by the platoon sergeant and the fire direction computers, prepares a mortar fire plan. Based on instructions from the company commander, he plans 81-mm mortar barrages and concentrations. Concentrations are planned on likely target areas both forward of and within the battle area and to support any counter-attacks (par. 132). He submits this plan to the company commander for approval. When approved, it is normally prepared in overlay form and distributed to the mortar and artillery forward observers and the rifle platoon leaders.

*d. Selection of Mortar Positions.* Based on the general position area directed by the company commander, the weapons platoon leader normally selects the exact position area for the squads, leaving the selection of the exact site for each mortar to the mortar squad leaders. Usually the three squads are located in one general firing position area. In selecting the firing positions, the platoon leader considers: providing maximum coverage of the company area; maximum and minimum close support range of the mortar; defilade; concealment; mask and overhead clearance; room for dispersion between squads; hard standing to support the base plate; routes for ammunition resupply; and security which may result from locating the position near a reserve platoon area. Initial positions may be necessary a short distance in rear of the FEBA to permit support of the combat outpost. See paragraphs 132 and 134.

*e. Selection of Antitank Squad Positions.* The exact firing position for each antitank squad is normally selected by the squad leader, based on instructions from the platoon leader. Observation and fields of fire forward of the position are essential. Back-blast clearance is always considered. It is desirable, whenever the terrain and tactical situation will permit, to select a position from which the squad can reinforce fires of other weapons along the FEBA as well as perform its primary antitank mission. The 106-mm rifle is employed on the carrier whenever possible in a position which affords partial defilade. It may be necessary because of enemy action to locate the weapon in defilade and move it into firing position only when engaging a target. The primary position selected should facilitate movement to alternate and supplementary positions. A number of alternate positions are selected to permit moving the weapon frequently while engaging enemy armor. If enemy observation of the battle area and conformation of the terrain preclude the use of the weapon mounted on the carrier, the ground mount is used, with the carrier being placed in a nearby covered position. The use of the ground mount is avoided whenever possible, since it restricts the mobility of the squad. See paragraph 132.

*f. Rocket Launchers.* The two rocket launchers organic to the platoon are employed by the platoon leader to furnish close-in antitank protection for the squads. They are normally used by the

mortar squads. A principal direction of fire is specified for each weapon.

*g. Communications and Control.* The squads of the weapons platoon employed in general support are controlled by the company commander through the weapons platoon leader. The platoon leader positions himself so as to best assist in the control of the squads, or as the company commander directs. Wire is used to the maximum extent possible to communicate with all squads, the FDC, and the forward observers. This wire system is supplemented by radio and by the wire facilities of the rifle platoons. The FDC is normally located close enough to the mortar positions so that commands may be given by voice. The platoon sergeant, or in his absence the senior mortar squad leader, normally supervises the mortar squads.

*h. Ammunition Resupply.* See paragraph 74.

*i. Forward Observers and Observation Posts.* The three forward observer parties occupy observation posts as directed by the weapons platoon leader, based on instructions from the company commander. In addition to adjusting fire, observers have a secondary mission of reporting enemy information. Mortar observation posts are selected which enable maximum observation of the approaches into the company area. These OP's are normally located in the forward rifle platoon areas in the vicinity of the rifle platoon CP-OP. The weapons platoon leader may establish a platoon OP to supplement the observation of the forward observers. This OP



is operated by the platoon leader, the platoon messenger, or any member of the platoon who is capable of adjusting mortar fire. When a mortar squad is attached to a rifle platoon, 1 FO party and 1 fire direction computer accompany the squad.

*j. Organization of Positions.* As the squads arrive at their assigned areas, each squad leader places his squad in a temporary firing position prepared to cover his assigned sector or principal direction of fire. As soon as the weapons are placed in temporary positions, the primary positions are constructed and camouflaged. Then the weapons are placed in the primary firing positions, and the positions are checked by the platoon leader at his earliest opportunity.

- (1) *Antitank squads.* Emphasis is placed on clearing fields of fire and providing back-blast clearance. After the primary squad position is prepared, the squad leader examines his position from the direction of the enemy to check on the camouflage and concealment. Ranges are determined to the most likely target areas, and range cards are prepared. Alternate and supplementary positions are prepared.
- (2) *81-mm mortar squads.* After the primary mortar positions are completed, the squads place their mortars in position and begin registration. Barrages are normally registered first, followed

by concentrations farthest from the battle area. Coordination in registration is necessary to avoid endangering security elements, reconnaissance elements, and work details forward of the battle area. The fire direction center maintains a firing data sheet with the data necessary to fire each barrage and planned concentrations. Alternate and supplementary positions are prepared.

#### **141. Communications and Contact**

a. In the defense, a complete wire system is installed for control of units and fires. Wire communication, though susceptible to enemy interception, is preferred because it is more secure than radio. However, a complete radio net is established and radios are usually placed on listening silence. Plans are made for its instant use in the event of wire failure.

b. Unless otherwise specified, a unit is responsible for maintaining contact with the unit on its right. The company commander normally specifies the action to be taken by the right forward platoon concerning contact with the right adjacent company. See paragraph 25.

#### **142. Company Observation Post and Command Post**

a. *Observation Post.* The company commander selects an observation post, normally in a forward platoon defense area. The company ob-

observation post should give the best possible view of the company defense area, its flanks and approaches. If observation is limited, the commander may establish more than one observation post to provide observation over the entire company area of responsibility. Although the observation post is his battle station, the company commander goes where his presence is required. He keeps the personnel in the command post informed of his location. The observation post is manned at all times by personnel of company headquarters, who report all enemy information.

*b. Command Post.* The company locates the company command post in the rear portion of the company battle area. Security for this installation is normally provided by personnel from within the command post. Additional security may be obtained by locating the command post near a reserve platoon position. It is located preferably in a defilade position that is concealed from air and ground observation. A covered and concealed shelter should be constructed whenever practical to facilitate uninterrupted command post operations under all conditions of enemy attack. Covered and concealed routes to the front and rear are desirable to facilitate communication and supply. Qualified personnel must be present in the command post at all times to insure immediate reporting or relaying of information to battle group.

## **Section IV. CONDUCT OF THE DEFENSE, FORWARD RIFLE COMPANY**

### **143. General**

*a.* The forward rifle company, as part of a larger force conducting the defense, may be required to execute withdrawal and delaying action. For a discussion of the conduct of retrograde movements as part of the defense, see chapter 5. This section deals with the conduct of the defense of a forward rifle company whose mission is to defend its assigned area.

*b.* For conduct of the combat outpost, see paragraph 126.

### **144. Conduct of the Defense During Daylight**

*a.* After the preparation of positions, troops of the forward company may be dispersed, with only a skeleton force occupying the positions, to reduce nuclear vulnerability and also as a deceptive measure. Upon threat of enemy attack, the troops reoccupy their positions. The commander normally positions himself at the company observation post.

*b.* The company commander alerts the forward platoons prior to withdrawal of the combat outpost to insure coordination of their withdrawal through the FEBA. Forces along the FEBA cover the withdrawal of the combat outpost by fire as necessary. As the enemy continues his advance, he is brought under an ever increasing volume of fire. Sentinels located forward of the FEBA report information of the enemy and call

for and adjust indirect fires. When the advance of the enemy threatens these security elements, they are withdrawn; they do not engage in close combat.

c. All leaders and forward observers search for targets for indirect fire weapons and call for and adjust that fire on the enemy. Tanks and antitank weapons open fire on appropriate targets when the enemy comes within effective range. If it is indicated that the enemy knows the location of the FEBA, all weapons along the FEBA open fire as the enemy comes within effective range of those weapons. If it appears the enemy is searching for friendly defensive positions, the fires of all except certain weapons may be withheld until the enemy is well within effective rifle range. All weapons along the FEBA engage appropriate targets within their sectors of fire. If no enemy armor is present, tanks, antitank squads, and rocket launchers may engage such targets as crew-served weapons, vehicles, and groups of personnel. Leaders actively control the fires of their units to insure that ammunition is being effectively expended. Weapons are shifted to alternate or supplementary firing positions as required.

d. The rate of fire increases as the enemy approaches the FEBA. If the attacking force contains tanks as well as infantry, the tanks are engaged by antitank weapons and medium artillery, while small-arms fire and light artillery are directed at the attacking infantry. Every effort is made to separate the tanks and infantry. The

company commander orders antitank squads and attached tanks to move to supplementary positions to reinforce the fires in the threatened area as required. If the infantry attack is repelled but the tanks continue to advance, small-arms fire is directed at tank periscopes and exposed tank crewmen.

*e.* If the enemy is repelled, he is pursued by all available fire. If he breaks contact with units in the battle area, local security is reestablished and patrols are sent forward to regain contact. During such periods, harassing and interdiction fires are delivered in areas where the enemy is likely to be regrouping. Troops along the FEBA reorganize, evacuate casualties, redistribute and resupply ammunition, and strengthen their defenses.

*f.* During the conduct of the defense, all leaders keep their next higher commander informed of the situation at all times. Aggressive leadership on the part of all leaders is essential. Fire team leaders assist their squad leaders in the control of the squads, particularly in fire control. The squad leaders normally do not fire their weapons except during the close-in defense of the area when the added fire of their weapon is required. The weapons squad leader controls all or a portion of his weapons or assists the platoon leader as directed (par. 138*b*(3)). During the conduct of the defense, leaders may move to a threatened area in order to exert personal leadership.

*g.* If the enemy continues his advance through

the close defensive fires, the platoon leader in the threatened area calls for the final protective fires for his defensive position. Barrages are delivered, and the platoon delivers maximum fires on the advancing enemy. Machinegun final protective lines are fired as appropriate. Automatic riflemen and riflemen fire within their sectors except as otherwise directed by their fire team leaders. Mechanized flamethrower, if available, engages the enemy. Elements to the flanks of the platoon reinforce their fires if possible. The company commander calls for the fires of other indirect fire weapons not engaged in firing barrages to reinforce the fires in the threatened area.

*h.* If it appears that a penetration of the FEBA is probable, the company commander orders the reserve to move to supplementary positions from which it can block the penetration and/or support units in the threatened area by fire. Should the enemy threaten or effect a penetration in the area of an adjacent company, the reserve is repositioned to protect the endangered flank and provide the company all-round protection. All movements of the reserve must be so timed that it will be in position before the enemy can reach its location.

*i.* If the enemy assault reaches the position, it is repelled by fire, grenades, and close combat. Fires of prepositioned portable flamethrowers are also utilized. Tanks are engaged with all available antitank weapons, including antitank grenades. Individuals along the FEBA continue firing until forced to take cover to protect them-

selves and their weapons from the crushing action of the tanks. Immediately after the tanks pass, they resume their firing positions and continue to fight. Tanks which penetrate the forward area are engaged by antitank weapons positioned in depth.

*j.* If the platoon area is penetrated or if it is threatened from the flanks or rear, the platoon leader may adjust his defenses by moving men and weapons from the least engaged area into supplementary positions to meet this threat. If it becomes necessary, he may improvise a reserve from available personnel and reinforce the threatened area. All weapons that can profitably engage targets within the penetration are fired. When necessary, the platoon leader calls for indirect fires in the penetrated area. If organized resistance within the penetrated area has ceased, the company commander may call for such fires. In addition, fires are placed across the base of the penetration to prevent the enemy from reinforcing his gains.

*k.* Should the enemy penetrate the forward platoons, the company normally attempts to limit the penetration with the reserve and destroy the enemy by fire, relying on a higher echelon to eject the enemy by counterattack. Exceptionally, the company may counterattack (par. 146).

#### **145. Conduct of the Defense at Night**

*a.* At night, reliance is placed on patrols, listening posts, and surveillance devices to detect the advance of the enemy and to prevent infiltration.



If the company is disposed in a more compact defense at night than during the daylight (par. 131e), added emphasis is placed on surveillance of the gaps to the flanks.

b. Security elements report the advance of the enemy and call for illumination and supporting fires. As the advance of the enemy threatens these security elements, they are withdrawn before they become engaged in close combat.

c. As the enemy approaches the forward platoon areas, illumination is used extensively to locate the enemy. If sufficient viewing devices are available, the area may be illuminated with only infrared light. Fires are opened on the order of leaders when surprise is desired. As a general rule, weapons are not fired until targets are visible. Rigid fire control by all leaders is required to prevent indiscriminate firing, which will only result in the needless expenditure of ammunition and the disclosure of positions. Leaders may direct some weapons to fire at flashes, and in some instances, at sounds. Fires of crew-served weapons are delivered using pre-determined firing data and stakes. The use of trip flares and field expedients such as the fougasse provide increased security and illumination.

d. When the enemy commences his assault, final protective fires are called for by the platoon leader in the threatened area. Barrages are delivered, and machinegun final protective lines are fired. Automatic riflemen and riflemen fire within their sectors except as otherwise directed

by their fire team leaders. Stakes, set up during daylight, assist them in covering their assigned sectors. Hand grenades are used to supplement other fires as the enemy gets close to the position.

*e.* Other aspects of the conduct of the defense at night are generally the same as for the conduct during daylight.

#### **146. Counterattack**

*a.* If the enemy succeeds in penetrating the forward positions and seizes or threatens critical terrain, all available fires are delivered in an attempt to destroy him. If these fires fail to destroy or eject him, the company commander must decide whether to leave his reserve in a position to block further penetration, or to counterattack. Normally a counterattack will not be attempted unless the enemy force has been stopped and is not being reinforced. The maneuvering force with available fire support must be strong enough to destroy the enemy force and restore the penetrated area. These conditions will seldom exist because the reserve will usually be required to block any force strong enough to penetrate the forward positions.

*b.* If a counterattack is launched, the entire reserve and attached tanks not actively engaged normally act as the maneuver force. All available fires are used to support the counterattack. The appropriate counterattack plan is implemented, modified by fragmentary orders as necessary to meet the existing situation. The maneuvering force, avoiding friendly positions, makes a quick,

decisive attack and assault and mops up the penetrated area. Following the counterattack, the company commander may order all or part of the reserve to occupy and defend the area regained, or he may order it to return to positions in rear and have the forward platoon reoccupy the area.

c. When the company commander decides to commit his reserve in a counterattack, he notifies the battle group commander immediately. He designates a temporary reserve from available personnel, such as personnel of company headquarters, walking wounded, and drivers. He may order the temporary reserve to occupy a prepared reserve platoon blocking position.

## **Section V. PERIMETER DEFENSE**

### **147. General**

a. The perimeter defense may be required when the company is separated from the remainder of the battle group either by enemy action or by its assigned mission. In this type defense, the company is physically disposed to meet an attack from all directions simultaneously.

b. Because of the nuclear target which the company presents when so disposed, the company occupies a perimeter only when forced to do so by enemy action. The company normally prepares its positions in the perimeter and then disperses until forced to occupy the positions by enemy action.

c. The basic considerations of defense (par. 122) are applied to the maximum extent possible.

#### **148. Distribution of Troops**

a. A perimeter defense established by a rifle company consists of a perimeter and a reserve area (figs. 31 and 32). Each of the platoons on the perimeter is assigned a portion to organize and defend. Depending upon the terrain, the mission, the enemy situation, and troops available, the company commander may employ 3 or 4 rifle platoons on the perimeter. If 4 platoons are used, the reserve may consist of a portion of a rifle platoon and elements of the weapons platoon and company headquarters, utilized as riflemen. If the terrain dictates the use of 3 platoons on the perimeter or the situation requires a larger reserve, the reserve is made up of 1 rifle platoon, elements of the weapons platoon, and the company headquarters.

b. The frontages of the company and of the platoons on the perimeter are generally the same as described for the defense in paragraphs 130 and 138, except that the company front is generally circular rather than linear. The company commander assigns platoon frontages based on the criticality of approaches, and observation and fields of fire available. Platoons with the most dangerous approaches are assigned narrower frontages. Gaps between platoons are covered by fire and observation. In close terrain, gaps on the perimeter are generally reduced. Occupa-

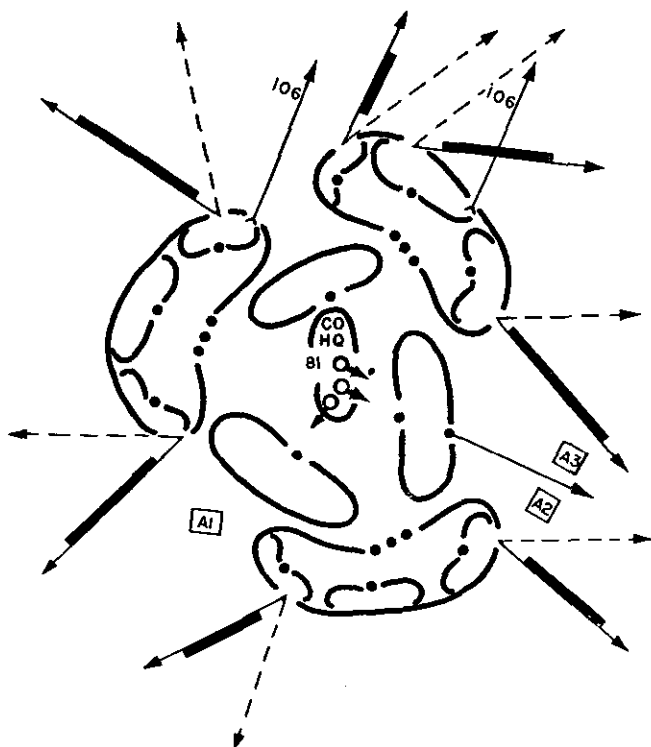

*Figure 31. Perimeter defense with three platoons on the perimeter.*

tion of gaps may be necessary at night to prevent infiltration.

c. Security is provided generally as described in paragraphs 135 and 138. Normally more sentinel and listening posts will be required to achieve the necessary degree of security.

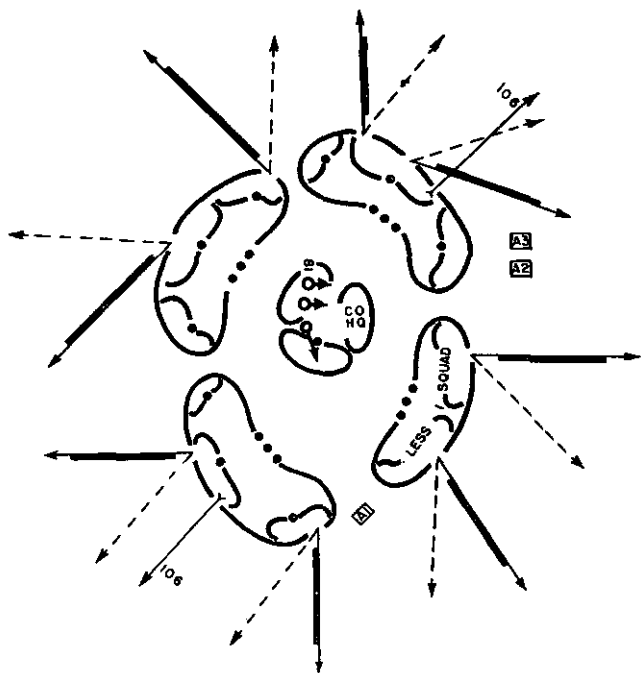

Figure 32. Perimeter defense with four platoons on the perimeter.

### 149. Fire Support

a. The employment of organic and attached weapons in the perimeter defense is generally as described in paragraphs 132, 134, 138, and 140.

b. Machineguns will normally be employed singly in order to provide adequate coverage of dangerous approaches.

c. The 81-mm mortar squads are usually located in the reserve area. In positioning the weapons,

minimum close support range is an important consideration. If the diameter of the perimeter is small, it may be necessary to separate the squads in order to provide some fire support to all portions of the perimeter.

*d.* Fires may be available to the company from fire support units located outside the perimeter. These fires are utilized as described in paragraph 132.

*e.* The company commander closely supervises the use of weapons on the perimeter to insure that gaps are adequately covered by fire and that maximum mutual support is achieved.

## **150. Conduct**

*a.* The conduct of the perimeter defense is generally the same as described in paragraphs 143 through 146.

*b.* If the enemy succeeds in penetrating the perimeter, the company normally counterattacks. All available troops not actively engaged are used to destroy or eject the enemy and to restore the portion of the perimeter which has been lost.

*c.* Resupply of the company in a perimeter is usually accomplished by air. Helicopters are normally used to evacuate casualties.

*d.* The company is alert for any withdrawal of the enemy force. Should such a withdrawal occur, elements of the company move out immediately to more dispersed positions to reduce the nuclear target presented. Patrols are used to maintain contact with the enemy.

## Section VI. REVERSE SLOPE DEFENSE

### 151. General

*a. Use.* A reverse slope defense is one organized on the portion of a terrain feature that is masked from enemy direct fire and ground observation from the front by the crest of the terrain feature. All or any part of the forces on the FEBA may be on the reverse slope, depending on the terrain in the area to be defended. A successful reverse slope defense depends on control of the crest either by fire or physical occupation. The battle group commander may direct the occupation of a reverse slope position under the following conditions:

- (1) When the forward slope is untenable because of enemy fire.
- (2) When the forward slope has been lost or not yet gained.
- (3) When the terrain on the reverse slope affords better fields of fire than the forward slope.
- (4) To avoid a dangerous salient or reentrant.
- (5) When possession of the forward slope is not essential for observation.
- (6) To assist in achieving deception and surprise.

*b. Advantages and Disadvantages.* In a reverse slope defense the forward elements of the battle area are protected from enemy ground observation and direct fire weapons. Because of limited observation, enemy indirect fire weapons



normally must deliver unobserved fires, thereby reducing their effectiveness. Through deception, the reverse slope defense offers the opportunity to engage the enemy before he has the opportunity to deliver his nuclear fire support. The defender may effectively employ deceptive measures such as dummy positions on the forward slope. These advantages permit greater freedom of movement, more detailed improvement of the position, ease of supply, and rest for the troops. A major disadvantage is the difficulty of maintaining observation of the enemy and the restricted range for direct fire weapons. Without observation, the effectiveness of friendly direct and indirect fires is limited. Obstacles and minefields on the forward slope cannot be covered by direct fire weapons. If the enemy seizes the crest, he will be attacking the battle area moving down hill while counterattacks to eject enemy forces must move uphill.

## **152. Organization of the Defense**

*a. Disposition of Troops* (fig. 33). The reverse slope is generally organized according to the basic considerations of defense (par. 122). Special considerations include the following:

- (1) Observation and Security (O&S) groups are established on or just forward of the topographical crest to give observation over the unit's entire front. These groups may vary in size from two men to a rifle squad (usually from the reserve platoon). They may be rein-

forced with machineguns, antitank weapons, and tanks. At night these groups are strengthened to prevent hostile infiltration and surprise. If the company is part of the battle group in a reverse slope defense, these groups may be controlled by the battle group commander.

- (2) The forward platoons are located within effective small-arms range of the crest of the hill to provide adequate fields of fire. Troops on the reverse slope are located to permit maximum fire on the crest, the approaches around the crest, and on the forward slope of adjacent terrain features. A desirable location for the reserve platoon(s) is the military crest of the next high ground to the rear, if within supporting range.

*b. Fire Support.* The employment of organic and attached weapons and the utilization of supporting fires are generally as discussed in paragraphs 132, 134, 138, and 140.

- (1) Machineguns and other automatic weapons are placed where they can obtain the most effective surprise fire on the enemy as he crosses the crest. Sectors of fire should provide maximum coverage between the FEBA and the crest. Machinegun final protective lines are designated as in the forward slope defense.
- (2) Antitank squads may be positioned in the reserve platoon(s) area more fre-

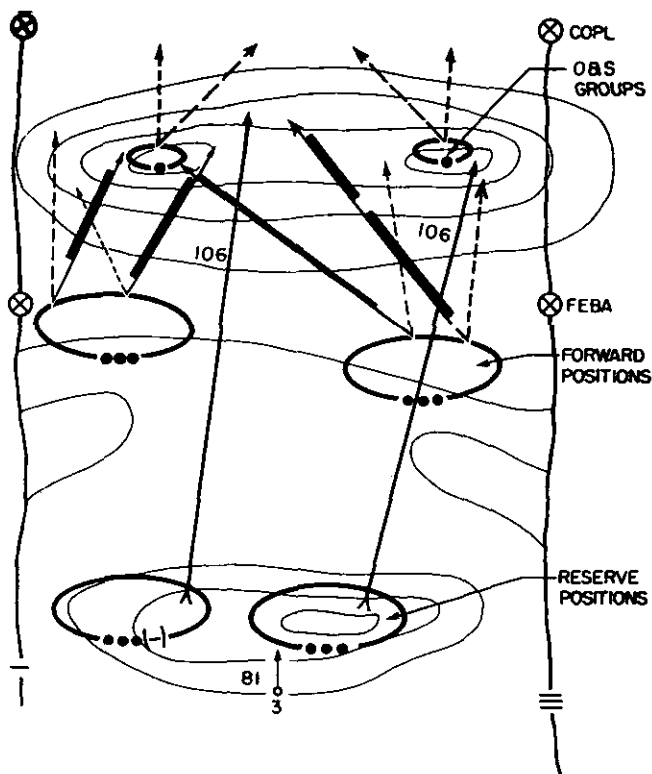

Figure 33. Rifle company in a reverse slope defense (schematic).

quently in the reverse slope defense than when defending the forward slope. If the next high ground to the rear of the forward platoons is within effective range of these weapons, firing positions on that ground will often provide better fields of fire for the antitank squads

than positions in the forward area.

- (3) The reserve platoon(s) will often be able to provide more effective fire support for forward platoons than in the defense of the forward slope.
- (4) Barrages are normally placed along the crest of the hill in order to deny that area to the enemy (par. 132*b*). When the FEBA is located about 500 yards from the crest, it may be more advisable to locate the barrages closer to the FEBA than to the crest. In such a case, concentrations are planned both on and short of the crest to keep the enemy under fire as he advances toward the area where the barrages are to be fired.

### **153. Conduct**

The conduct of a reverse slope defense generally parallels that of a forward slope defense. The O&S groups give warning of an enemy approach and delay and disorganize him with long-range fires. To give a better coverage of the front during periods of poor visibility, warning and illuminating devices such as flares, searchlights, infrared equipment, and antipersonnel mines are used extensively. As the enemy forces the O&S groups to withdraw, prearranged concentrations are delivered on the forward slope to disrupt the enemy's attempts to mass for an assault. The withdrawal of automatic weapons first permits these weapons to occupy their primary firing positions before the enemy reaches

the crest. Direct fire weapons within the battle area withhold their fires until suitable targets appear. As the enemy crosses the crest, barrages (or concentrations) are fired. All other indirect fire weapons capable of doing so fire concentrations in support of the threatened area. If a penetration is made, the counterattacking force destroys the enemy in the penetrated area and reestablishes the O&S groups on the crest.

## **Section VII. DEFENSE OF A RIVERLINE**

### **154. General**

*a.* The rifle company, as part of a larger force defending a riverline, will frequently be assigned a much wider frontage than when defending in other terrain. As the river obstacle facilitates the adoption of the mobile defense by a higher echelon, the mission of a forward company will frequently be to delay forward of defensive positions, or to defend initially, prepared to withdraw and fight a delaying action. For a discussion of techniques of withdrawal and delaying action, see chapter 5.

*b.* The battle group order may require the company to defend on or close to the near bank, or if the terrain is not adaptable, on terrain farther to the rear which controls approaches from the river. When the FEBA is near the river, the COPL is located on the far side. When the FEBA is farther to the rear, the COPL may be located either on the near or far side of the river, depending on the terrain.

c. The advantages afforded by a river obstacle are exploited to the maximum. However, care must be taken to insure that troops and leaders do not overestimate the value of the river as an obstacle.

d. In planning the defense, consideration must be given to the capability of the enemy to cross the river by a variety of means, such as individual floatation devices, boats, armored amphibious vehicles, and helicopters.

### **155. Organization of the Defense**

a. *Disposition of Troops.* Forward platoon defense areas are selected and organized generally as described in paragraphs 131 and 138. When the FEBA is near the river, the forward platoons are positioned to cover the most dangerous crossing areas. When the FEBA is farther to the rear, forward platoons are positioned to cover the most dangerous approaches from the river. In covering the wide frontage which may be assigned, gaps between platoons are increased rather than increasing the frontages occupied by the platoons. The company commander retains a reserve whenever possible, even though the assigned frontage may be great. Many supplementary reserve positions may be necessary to provide depth in areas of a likely enemy crossing and to permit defense against helicopterborne attack.

b. *Fire Support.* The employment of organic and attached weapons and the utilization of sup-

porting fires are generally as discussed in paragraphs 132, 134, 138, and 140.

- (1) When the FEBA is near the river, machineguns are positioned to cover dangerous crossing sites and avenues of approach to them. Because of the nature of the terrain along a river, excellent fields of fire will often be available, permitting grazing enfilade fire to be delivered along the front. Final protective lines may be established to graze the river or the far bank.
- (2) Antitank squads and attached tanks are positioned where they can cover likely crossing sites for amphibious vehicles and cover avenues of approach to the river.
- (3) When the FEBA is near the river, barges are normally planned on the far bank at probable crossing sites (par. 132b).

*c. Security and Surveillance.* Security and surveillance are as described in paragraphs 125, 135, and 138, with the following modifications:

- (1) The combat outpost, if located on the far bank, will seldom have tanks attached, unless bridges or fords exist which will be left intact until withdrawal of the combat outpost. Plans for withdrawal of this element include both primary and alternate crossing means. The combat outpost may have personnel carriers attached, or helicopters may be used.

When the COPL is on the near side of the river, aggressive patrolling is conducted on the far bank. Emphasis is placed on locating lucrative nuclear targets and on determining where the enemy will attempt to cross.

- (2) When the FEBA is located near the river, local security elements will often be located on the far bank. Aggressive patrolling is conducted on the far bank. Patrols are particularly alert for any withdrawal of the enemy which might indicate their use of nuclear weapons. Plans provide for both primary and alternate crossing means for these security elements.
- (3) Special consideration is given to providing adequate surveillance of rear areas to detect airborne attack.

*d. Use of Armored Carriers.* Special consideration is given to attaching personnel carriers to the combat outpost, patrols, and other security elements which must operate on the far bank. During the conduct of the defense, it is normally desirable for the reserve to be mechanized to permit it to move rapidly to supplementary positions. See paragraphs 134 and 138.

## **156. Conduct**

*a.* Upon withdrawal of security elements to the near side of the river, the destruction of all available crossing means which the enemy might



use is completed. Bridges are blown, fords are mined, boats and barges are destroyed, etc.

b. When the FEBA is near the river, the defender attempts to keep the enemy from crossing. The company reserve is shifted as necessary to block a possible penetration. If the enemy succeeds in crossing and effects a penetration, the company contains the penetration to permit its destruction by the counterattack of a higher echelon. Only under exceptional circumstances will the company have the capability of counter-attacking.

c. If the FEBA is located farther to the rear, emphasis is placed on determining the enemy's principal crossings, blocking his exit from the crossing areas, and destroying him with nuclear weapons and counterattack while he is astride the river. Destruction of the enemy force, rather than restoration of the FEBA, is the primary consideration.

## **Section VIII. RESERVE RIFLE COMPANY**

### **157. Missions and Employment**

a. The reserve of a battle group in defense consists generally of 1 or 2 rifle companies and a portion of a tank company. The tanks may be retained under battle group control, or they may be attached to a reserve company.

b. A reserve rifle company may be assigned one or more of the following tasks:

- (1) Block or canalize an enemy penetration.

- (2) Protect the battle group flanks and rear.
- (3) Act as maneuver element in a counter-attack.
- (4) Perform security and surveillance missions.
- (5) Assist in preparing forward company defense areas.
- (6) Cover the withdrawal of forward companies.
- (7) Relieve a forward company.

c. The battle group commander designates primary, alternate, and supplementary reserve positions in the battle group rear area. He specifies the priority of construction and designates the positions to be occupied initially. After preparation of the positions, the company may be held in a concealed assembly area.

### **158. Organization of Positions**

a. Reserve positions are organized generally the same as in a forward company area (pars. 130-142).

b. The 81-mm mortar squads may be directed to reinforce the fires of the mortars of a forward company (par. 58). In this case, barrages are planned and fired as requested by the reinforced unit. When no reinforcing mission has been assigned, the mortars of a reserve company do not fire barrages.

c. The construction of obstacles is coordinated closely with battle group to permit the desired movement of friendly forces in the battle group rear area.

## 159. Security and Surveillance

*a.* A reserve rifle company will frequently be required to attach elements (normally rifle platoons) to the forward companies for use on the combat outpost.

*b.* When an RSL is established, a reserve rifle company may be given responsibility for establishing and controlling R&S forces (par. 127).

*c.* A reserve rifle company may be given the responsibility for establishing the entire COPL forward of the battle group. Situations in which this may be done are when time for preparation of the forward company areas is limited, when the COPL is beyond supporting distance of the forward companies, and when a COPL is to be established forward of new defensive positions in a night withdrawal (par. 126).

*d.* A reserve rifle company provides security and surveillance of the battle group rear area as directed by the battle group commander. The battle group rear area is the area included by the flank boundaries, a line generally parallel to the front running through the rear of the forward company boundaries, and a line generally parallel to the front running through the rear of the battle group flank boundaries. The assigned mission will normally require the company to provide protection against attack by airborne forces, guerillas, and infiltrators in the rear area (par. 129). Rear area security and surveillance measures may include use of observation, sentinel, and listening posts; foot and motorized patrols;

road blocks; and warning and surveillance devices (pars. 135 and 138).

## **160. Counterattack Planning**

*a.* The battle group commander directs and supervises the preparation of the battle group counterattack plans. The battle group reserve is normally the maneuvering force, though unengaged elements of the battle group are often included. Plans normally call for the attachment to the maneuvering force commander of all friendly forces in the penetrated area. A reserve rifle company commander may or may not be the commander of the maneuvering force.

*b.* In each battle group counterattack plan, the reserve rifle company will normally be assigned a line of departure, direction of attack, and objective. An attack position may also be assigned if close coordination is required. The company commander prepares a plan for his company to implement each of the battle group plans. Subordinate leaders of the company also prepare their plans. For a discussion of counterattack planning, see paragraphs 137 and 130 through 146.

## **161. Conduct**

*a.* Throughout the conduct of the defense, the reserve company commander keeps informed of the situation and, in turn, informs his subordinates. He anticipates the possible commitment of his company and prepares plans accordingly. When instructions are received from the battle group commander, the entire company must re-

act quickly and effectively. Reliance is placed on fragmentary orders.

b. The company or its elements may be ordered to move to supplementary positions to block or canalize an enemy penetration or to protect the flank(s) of the battle group. Movement is made rapidly (by vehicle if possible) over previously reconnoitered routes which afford maximum cover and concealment. For conduct of the defense from these positions, see paragraphs 143 through 146.

c. If the enemy effects a penetration, the company may be ordered to participate in a counterattack. The counterattack plan implemented will normally have to be revised slightly by fragmentary orders to make it applicable to the existing situation. For conduct of the counterattack, see paragraphs 143 through 146. The success of the counterattack depends largely on surprise, boldness, and speed of execution. When the enemy has been destroyed or ejected from the penetrated area, the company may be ordered to assume responsibility for that area or to move to positions in the battle group rear. If the counterattacking force is unsuccessful in restoring the battle area, it consolidates the ground gained.

## **Section IX. RELIEF IN PLACE**

### **162. General**

a. Secrecy is essential in the preparation for and conduct of a relief. As darkness or reduced

visibility facilitates the preservation of secrecy, reliefs are more frequently made at night than during daylight. The relief is conducted as rapidly as possible, consistent with secrecy and control.

b. During a relief, units are particularly vulnerable to nuclear and nonnuclear fires. In order to avoid concentration of troops, it is desirable to conduct the relief one platoon at a time, though the requirement may exist for the simultaneous relief of all company elements.

### **163. Planning the Relief**

Plans are as detailed and complete as time permits and include:

a. *Reconnaissance.* Preceding the relief, the incoming company commander and platoon leaders conduct a daylight reconnaissance of the defense area, routes, and locations where guides will be met. While on this reconnaissance, they familiarize themselves with defensive dispositions and plans, the terrain, and the enemy situation. The outgoing company commander makes necessary plans to accomplish the new mission. Since the outgoing company commander usually needs to remain with his unit, he designates representatives to reconnoiter the route, guide locations, and the new area to be occupied, as appropriate.

b. *Liaison Personnel.* The commander of the incoming company and his platoon leaders take liaison personnel forward with them on their reconnaissance and arrange to leave them on the

positions to be occupied. The liaison personnel keep informed of all changes occurring after the reconnaissance. When practicable, liaison personnel from the outgoing unit remain on the position long enough to further orient the newly committed unit commanders.

*c. Exchange of Crew-Served Weapons, Supplies, and Equipment.* Commanders of the incoming and outgoing units arrange for the mutual exchange of crew-served weapons which cannot be easily moved, or when necessary to insure the effective delivery of fires. Such exchange is based upon authority included in the relief order of the next higher commander. Outgoing units normally leave excess ammunition, field fortification material, wire lines and telephones, range cards, and minefield records on position. Usually radios are not exchanged.

*d. Attachments.* In order to simplify control and reduce the number of guides, an incoming rifle company commander normally attaches weapons crews to the rifle platoons in whose areas they will be positioned. The outgoing rifle company commander also normally attaches weapons crews in the same way. Both incoming and outgoing rifle platoon leaders normally attach weapons crews to the rifle squads in whose area they are positioned. Attachments during the relief are generally made for the movement only.

*e. Guides.* Routes should be reconnoitered and marked in advance by the guides. In order to achieve dispersion, different routes should be

selected by the incoming and outgoing companies. The activities of the guides should be supervised to insure efficiency and avoid unnecessary delays. Each incoming company is usually guided by its own personnel to the rear of the battle area of the outgoing company. From this point it is guided by personnel of the outgoing company. This movement should be continuous. Personnel from the outgoing company guide their unit during the complete movement to the rear.

*f. Periodic Reports.* All commanders make provision for periodic progress reports to be rendered during the conduct of the relief.

*g. Security.* Normal activities are simulated as much as practicable. Local security elements are normally maintained by the outgoing unit and are usually the last portion of that unit to be relieved. Other security measures provided for are: no mention of the relief in the clear over electrical means of communication; limiting the size and activities of reconnaissance parties; restricting the movement of vehicles; and enforcing light and noise discipline.

*h. Relief Order.* The relief order, which follows the standard operation order sequence, includes such specific items as: the times for the relief to begin and end; time or condition for change of responsibility for the battle area; routes; attachments; march formations; designation and location of crew-served weapons, equipment, and supplies; security measures; action to be taken in the event of hostile action during the relief; and provision for periodic re-



ports by subordinate leaders during the conduct of the relief.

#### **164. Conduct of the Relief**

*a. General.* During this period, troops are particularly vulnerable to attack. Delays are held to a minimum. However, dependent upon the time available and the enemy's capability, the relief may be phased by platoon.

*b. Incoming Company.* At the time prescribed for the start of the relief, the incoming company moves forward to the company release point, where it is released to the control of the company commander. Without delay, it is led forward to the platoon release point. Platoon guides lead the platoons forward to the squad release points, and from here guides lead the squads to their positions. The incoming and outgoing squad leaders then relieve a few men at a time until the relief is completed. Sufficient time is allowed for each man of the incoming squad to be thoroughly oriented by the man he is relieving.

*c. Outgoing Company.* As each squad (with attachments, if any) is relieved and the squad leader has been relieved of responsibility for the position, the squad moves directly to the rear to the platoon assembly area. Upon being relieved of responsibility for his platoon defense area, the platoon leader joins his platoon in the assembly area and moves it to the company assembly area without further delay. When the company commander is relieved of responsibility for the company area, he rejoins his company.

Throughout the conduct of the relief, commanders at all levels are responsible for dispersion and security of their units. If sufficient time exists, the relief of self-propelled weapons should be phased so as to minimize noise and movement.

### **165. Command During the Relief**

*a.* During the conduct of the relief, commanders at each echelon should be together at the command post or observation post of the outgoing unit to facilitate control and communication.

*b.* The execution of a relief takes place under the direction of the commander of the unit to be relieved. He usually remains responsible for the defense of the area until the majority of the relieving unit is in position and communication and control have been established by the incoming commander. The exchange of responsibility is agreed upon by the commanders concerned and verified by receiving the concurrence of their next higher commanders. If an attack occurs before the incoming commander assumes the responsibility for the defense, he assists the outgoing commander with all means available to him. In this event, elements of the incoming company in the area are attached to the outgoing company for the conduct of the defense.

## CHAPTER 5

# RETROGRADE MOVEMENTS

---

### Section I. GENERAL

#### 166. Types and General Considerations

a. A retrograde movement is any movement of a command to the rear or away from the enemy. It may be forced by the enemy or made voluntarily. It may be classified as a *withdrawal from action*, a *delaying action*, or a *retirement*.

b. Every retrograde movement made from hostile contact must be initiated by a withdrawal from action.

c. The decision to effect a retrograde movement by the company or its elements must receive the approval of the battle group commander.

d. Movement during a retrograde action may be by foot, ground vehicle, aircraft, or combination of these means.

e. The rifle company normally participates in a retrograde movement as part of a larger force (FM 7-40). Retrograde movements may be made frequently during the conduct of the mobile defense (par. 120).

## **167. Tactical Considerations**

*a.* During a retrograde action, commanders must strive to keep the morale of the troops high. Troops should be made to understand that the action is part of a sound plan with a specific purpose. False rumors and exaggerated reports of enemy capabilities are counteracted by keeping men informed. Forceful leadership, strict discipline, control, and prior planning are required to prevent deterioration of morale. The presence of leaders and commanders at critical points greatly assists in maintaining the confidence of the troops.

*b.* Terrain is exploited to the maximum. Good observation and fields of fire are sought to permit engaging the enemy at long ranges. Maximum use is made of cover and concealment. Natural obstacles are supplemented with minefields, demolitions, and other artificial obstacles and with the use of CBR and nuclear munitions to strengthen defenses, protect exposed flanks, and delay the enemy. Emphasis is placed on denying avenues of approach and critical terrain.

*c.* Consistent with the assigned mission, maximum casualties are inflicted on the enemy while trading space for time. Efforts are made to force the enemy to mass and to canalize him into areas to permit his destruction by nuclear and nonnuclear fires.

*d.* Because control is difficult, plans and orders are necessarily detailed. Execution of the plans is often decentralized to low levels. As the action cannot be predicted with a great degree of accuracy, plans should be flexible. Alternate plans

are prepared as time permits. Leaders at all echelons are thoroughly familiarized with the concept of the operation to permit them to make sound decisions in situations when contact with higher commanders is lost.

*e.* Freedom of action is maintained whenever possible. Close combat is avoided unless required to accomplish the mission. Rapid movement of units withdrawn from action may be expedited by the use of ground and air transportation. Special consideration must be given to traffic control at critical points. Priority for the use of transportation should normally be given to detachments left in contact and covering forces.

*f.* Enemy forces may be expected to follow up any retrograde movement relentlessly and to strike withdrawing forces from any direction. This necessitates special security measures at every echelon. Mobile security forces, continuous reconnaissance, rapid movement, antitank and anti-aircraft defense, and measures to counter enemy airborne landings are utilized to provide this security. Enemy action from any direction must be anticipated.

*g.* Civilian refugees may present difficulties in the conduct of operations by blocking withdrawal routes. Plans are made to cope with this problem. Assistance in handling refugees is normally provided by higher headquarters.

*h.* Detailed advance planning must provide for adequate supplies and equipment to conduct the retrograde action at each successive position. The level of supply should not be greater than the

anticipated need. Every precaution is taken to prevent material from falling into enemy hands; that which cannot be evacuated is destroyed.

*i.* Every effort is made to prevent wounded men from being captured. The use of fixed-wing aircraft and helicopters speeds the evacuation of wounded and releases ground transportation for other purposes.

*j.* Close cooperation and coordination are required when a withdrawing force passes through another friendly unit. Plans include measures for mutual recognition, routes to be used, points of passage, and priority of routes in rear. The passage of lines is accomplished as quickly as possible to reduce the nuclear target presented. The withdrawing unit commander is responsible for notifying the unit in position when the last withdrawing element has passed.

### **168. Withdrawal From Action: General**

*a.* A withdrawal from action is an operation by which all or part of a deployed force disengages from the enemy in order to position itself to initiate some other action. It may be followed by a retirement, a delaying action, or a defense from another position.

*b.* A withdrawal from action may be conducted during daylight or at night.

*c.* Whenever possible, withdrawals are made voluntarily with as much secrecy as possible in an attempt to deceive the enemy. The best conditions for deception are found at night or under other conditions of reduced visibility. For this

reason, the technique involved when the withdrawal is based on deception is referred to as the *night withdrawal*. The *night withdrawal technique* may be used during daylight hours in smoke or haze, or during inclement weather, and in the absence of definite enemy pressure.

d. When a unit is forced to execute a withdrawal and it is not likely that the secrecy of the operation can be preserved, the unit must disengage by fighting the enemy until freedom of action is regained. Since this type of action envisions conditions of good visibility and the lack of secrecy, it is referred to as the *daylight withdrawal*. Should enemy pressure force a withdrawal at night, the *daylight withdrawal technique* is used.

e. Complete and detailed plans must be made for a withdrawal. They include: the time and priority for withdrawal of forward units (H-hour); control measures (routes or zones, assembly areas, rallying points, and weapons attachments); complete reconnaissance; the nature of the forces to be left behind the main body (mission, size, disposition, and weapons with the covering force or the detachments left in contact); administrative details; security measures; and the mission to be performed in the new area. As soon as the decision to withdraw is known, warning orders are issued to platoon leaders. When possible, orders are transmitted by messengers or by the company commander in person to avoid assembling leaders of units in contact. Withdrawal orders are not transmitted by elec-

tronic means except in case of extreme emergency.

*f.* Leaders conduct as detailed a reconnaissance of the new positions and the terrain to be covered during the movement to those positions, as the time will permit. Because of enemy action, leaders of units in contact may frequently be required to remain with their units while their representatives conduct this reconnaissance.

### **169. Retirement**

*a.* A retirement is an operation in which a force withdraws without enemy pressure to avoid combat under the existing situation. When a withdrawal from action precedes the retirement, the actual retirement begins after the main forces have broken contact with the enemy and when march columns have been formed.

*b.* A rifle company normally participates in a retirement as a part of a larger force. The company receives specific orders as to the mission, time and type of movement, routes, and march objectives. The company may provide part of the security for the main body (rear, flank, or advance guards), or it may march as part of the main body. For a discussion of the actions of the company during movement, see chapter 2.

### **170. Stay-Behind Forces**

*a.* During a retrograde movement, the rifle company or its elements may be ordered to permit bypassing by enemy elements in order to act as stay-behind forces; or its withdrawal may be



cut off by enemy action. The actions of these forces behind enemy lines can greatly assist in the accomplishment of the overall mission of a higher unit.

*b.* The actions of a unit intentionally acting as a stay-behind force will be directed by its assigned mission. Essentially, the unit is a task force utilizing a specific means of entry into the enemy rear area. The force normally occupies a concealed area until the enemy attack echelon has passed. Appropriate missions for a stay-behind force include calling for and adjusting fires; locating nuclear targets; reporting enemy information; and destroying key installations such as enemy communication facilities, supply installations, command installations of large units, and nuclear delivery means. The conduct of offensive actions of stay-behind forces is generally as described for raids (pars. 117-119). The stay-behind force attempts to keep its presence unknown to the enemy, consistent with the accomplishment of its mission. Prior to the operation, plans are prepared in detail, to include plans for the resupply and withdrawal of the force. Helicopters may frequently be used in withdrawing the force after accomplishment of its mission.

*c.* Forces which are cut off by enemy action, though not designated stay-behind forces, can accomplish many of the same type missions as described in *b* above.

- (1) Upon being cut off, the unit commander concerned should immediately attempt to notify his next higher commander of the

situation and request instructions. The next higher commander's plan may call for the unit to fight its way through enemy lines to rejoin friendly forces. In such a case, the action is closely coordinated, and the higher unit may assist the breakthrough by providing supporting fires and executing a limited objective counterattack. The higher commander may decide, however, to employ the cut off unit to destroy enemy rear installations, attack enemy forces from the rear, or otherwise disrupt the enemy attack. The action of the unit would then be as discussed in *b* above.

- (2) If the cut off force is out of communication with its parent unit, the commander's decision on the action to be taken is based on his knowledge of the situation and the overall concept for the operation. He employs his unit so as to best contribute to the overall mission. Strong leadership at all levels is essential to maintain the combat effectiveness of the unit. In deciding on the action to take, the commander considers: the status of his unit (condition of the men, strength, mobility, and supply of food, ammunition, and fuel); enemy strength and mobility; probable location of friendly forces; terrain; and the overall mission of his parent unit. When possible, he attempts to fight his way

through to friendly forces when such action has a reasonable chance for success. If the unit is deep within enemy territory with little chance of rejoining friendly forces with the bulk of its equipment, the commander may determine to effect maximum destruction on the enemy rear area prior to attempting to rejoin. Maximum use is made of captured materiel. The commander retains his force as a unit, evading the enemy except when actually attacking an installation or an enemy force. Maximum use is made of patrols to provide security and information of the enemy and terrain. If his unit is surrounded and his force is adequate, the commander attempts to break out of the encirclement. The force continues to fight as a unit until it no longer has the capability of fighting. The commander may then divide the unit into small groups to facilitate their infiltration through enemy areas. For techniques of evading the enemy while returning to friendly lines, see FM 21-76.

## **Section II. NIGHT WITHDRAWAL**

### **171. General**

*a.* The success of a night withdrawal depends primarily on secrecy and deception. The with-

drawal of troops and weapons and their subsequent assembly is accomplished as quietly as possible. The withdrawal of the main body is protected by the detachments left in contact. By their fires, patrolling, and other deceptive means, detachments left in contact simulate the normal activities of the unit. In preparation for a night withdrawal, special tactical measures may be used to confuse and disrupt the enemy; for example, limited objective attacks and raids may be prescribed by the battle group commander.

*b.* The battle group order for the night withdrawal prescribes: the time of withdrawal; general strength and composition of the detachments left in contact; company assembly area, routes of withdrawal, route priorities, and other measures to control the movement; action to be taken in case of hostile attack; attachment of supporting units to the company for the withdrawal; and instructions pertaining to the withdrawal of the detachments left in contact. The order also covers the organization of the new position to the rear, if appropriate.

## **172. Planning and Preparation**

*a.* Based on the battle group order, the company commander initiates his planning and issues a warning order immediately. Maximum use is made of available daylight for reconnaissance. All leaders, including squad leaders, conduct as thorough a reconnaissance of routes to the rear and of new positions as available time and the enemy situation will permit (par. 168). Further

restrictions on the size and movement of reconnaissance parties may be prescribed by the battle group commander. Activities in preparation for the withdrawal must not compromise the secrecy of the operation.

*b.* Frequently the reconnaissance of the new defensive position to the rear will have to be accomplished by representatives of the leaders of the company (par. 168). In this case, the company commander normally directs the weapons platoon leader to take a reconnaissance detail to the new area. This detail should consist of at least one representative from each rifle platoon (normally the platoon sergeant) and may include others, such as communication personnel. The weapons platoon leader, based on guidance from the company commander, selects platoon defense areas, weapons positions, and makes other appropriate plans for the company commander pertaining to the organization of the new position. Platoon representatives prepare plans for the organization of new platoon defense areas. Normally, the disposition of units in the new position will be the same as for their current position for simplicity. When time permits, the reconnaissance detail installs wire lines on the new position. The reconnaissance party will frequently remain in the new area rather than return for the withdrawal.

*c.* The company commander may designate platoon assembly areas for the withdrawal and platoon routes to the company assembly area. If close control over the movement of the platoons

is not required by the company commander, he may delegate the selection of these measures to his platoon leaders. Platoon assembly areas are normally located immediately in rear of each platoon position. The company commander designates a portion of the company assembly area for each platoon. He specifies measures to be taken to secure the company assembly area.

*d.* The platoon leader may designate squad assembly areas and routes to the platoon assembly area, or he may delegate this selection to the squad leaders. A squad assembly area is normally immediately in rear of the squad position.

*e.* Consistent with secrecy requirements, routes and assembly areas are marked for ease of identification at night. Plans are made for use of guides.

*f.* To facilitate control during the withdrawal, supporting weapons are normally attached to the rifle platoons in whose areas they are located. Platoon leaders may further attach these and their organic weapons to the rifle squads. Such attachment normally is effective on withdrawal.

### **173. Detachments Left in Contact**

*a.* The mission of the detachments left in contact is to protect with withdrawal of the main body by deception and resistance. The strength specified usually does not exceed one-third of the rifle strength of the company, augmented by certain supporting weapons. Normally one rifle squad is left in each platoon area of the forward rifle company (fig. 34). As the platoons with-

draw, men of the squad left in place move as necessary to cover the most dangerous enemy approaches into the platoon area and at the same time furnish close protection for supporting weapons. The squad from the reserve platoon(s) may patrol the company rear area or block a dangerous approach into the flank or rear. Sniperscopes and other night vision devices will assist the detachments left in contact in detecting any enemy action that might hinder the withdrawal.

b. Approximately one-half of the crew-served weapons located in the area of the forward rifle company are attached to the detachments left in contact for their protection, for the protection of the withdrawing main body, and to establish normal fire patterns to deceive the enemy. Not more than two of the 81-mm mortars are left in position to fire.

c. If there should be a definite threat of enemy armor, or if deception would be jeopardized by moving tanks and 106-mm rifles, these weapons may remain with the detachments left in contact. Since tanks and 106-mm rifles are not able to operate with maximum effectiveness during periods of reduced visibility, they may be withdrawn by infiltration prior to withdrawal of the main body. Those tanks and 106-mm rifles remaining withdraw immediately before or at the same time as other elements of the detachments left in contact. Rocket launchers may be left with the detachments left in contact for close-in antitank protection.

d. Usually, the company executive officer com-

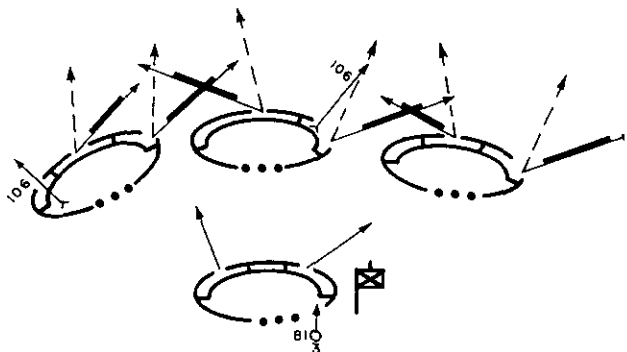

INITIAL COMPANY DEFENSE  
AREA AS OCCUPIED DURING DAYLIGHT

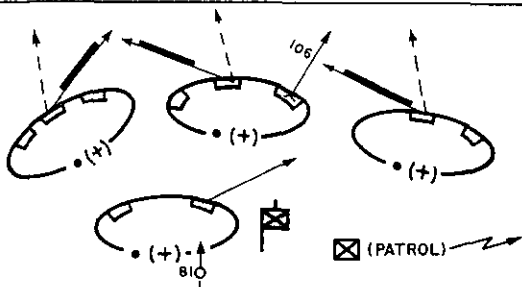

DISPOSITION OF DETACHMENTS LEFT IN CONTACT

Figure 34. Detachments left in contact.

mands the company detachments left in contact. A rifle squad leader commands the platoon detachments.

e. A reserve rifle company normally does not leave detachments left in contact, as the reconnaissance platoon is usually used to fulfill its missions in the battle group rear area. If the reconnaissance platoon is not so utilized, a reserve company may be required to provide a pla-



toon for security in the battle group rear area. The combat outpost for the *new* defensive area is normally established for the battle group by a reserve company.

#### **174. Utilization of Armored Carriers**

*a.* If armored carriers are attached to the company for the withdrawal, the company commander normally attaches carriers to the detachments left in contact and retains any additional carriers under company control. Those vehicles to be attached to the detachments left in contact should be positioned as close to the units they are to carry as the tactical situation will permit. Additional carriers for use by the main body should be kept in an assembly area in rear in order to reduce the problem of maintaining secrecy during the withdrawal.

*b.* If carriers are already attached to the company and are located in or near the forward platoon areas, the company commander must decide how best to withdraw the vehicles without compromising the secrecy of the operation. If possible, the carriers to be used by the main body are withdrawn, a few at a time, to an assembly area in the rear, well before the time of withdrawal. This action can often be made to appear as normal movement within the battle area. Movement of vehicles is made as quietly as possible and artillery and mortar fires are used to cover the noise of the movement. Every effort should be made to maintain secrecy and to deceive the enemy.

## **175. Conduct of the Night Withdrawal** (fig. 35)

a. The rearward movement of all rifle company elements, less the detachments left in contact, begins simultaneously at the designated time. Individuals move to squad assembly areas; squads move to platoon assembly areas; and platoons move to the company assembly area. Column formations are normally used to facilitate control. Movement is made quietly and rapidly. Consistent with the battle group traffic control plan and the reconnaissance made by platoon leaders, platoons may be dispatched to the rear immediately upon their arrival at the company assembly area. The entire main body of the company may be assembled prior to movement from the company assembly area, though such halts are avoided if possible. Every effort is made to maintain continuous movement. Transportation meets the company as far forward as practicable. The limit for its forward movement is prescribed by the battle group commander. Vehicles move singly or in small groups, and all motor movements are made using blackout or infrared lights.

b. The detachments left in contact provide the primary security for the company's withdrawal. The company commander provides for additional close-in security for the main body during the movement to the rear through the use of small detachments to the front and rear of the main body and elements to block routes into the flank. Radio listening silence is normally maintained by the main body. Wire lines along the route

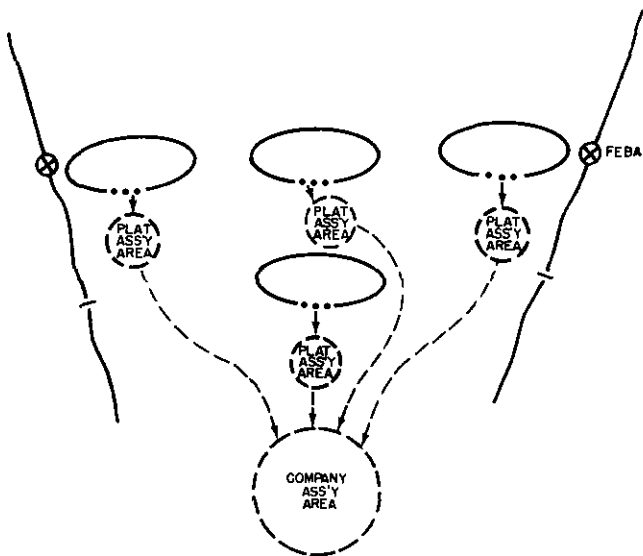

ELEMENTS OF THE COMPANY SPECIFIED BY HIGHER HQ REMAIN AS DETACHMENTS LEFT IN CONTACT. THEY WITHDRAW IN A SIMILAR MANNER IF NOT UNDER PRESSURE; IF UNDER PRESSURE THEY WITHDRAW AS SHOWN IN FIG 36

*Figure 85. Night withdrawal (schematic).*

may be used for communication with the battle group commander.

c. At the time specified for the withdrawal, the commander of the detachments left in contact (normally the executive officer) assumes responsibility for the area. Squads in each forward platoon area move as planned to cover dangerous approaches and protect crew-served weapons. Control is exercised through the use of existing wire lines. Sufficient radios are left with the detachments left in contact for communication with

battle group and for simulation of normal traffic on the company nets. All actions of the detachments left in contact are designed to simulate the normal activity of the company.

*d.* If the detachments left in contact are attacked, they defend within their capability. They do not withdraw without authority of the commander of the battle group detachments left in contact.

*e.* At the specified time or on order, the detachments left in contact withdraw simultaneously. Squads normally move directly to the company assembly area where all are assembled. Upon withdrawal, existing wire lines are disrupted by removing sections of the wire. Vehicles are located as far forward as practical. The detachments left in contact provide for security during the movement by use of small security groups. The reconnaissance platoon will often screen the movement and maintain contact with the enemy.

### **Section III. DAYLIGHT WITHDRAWAL**

#### **176. General**

*a.* A daylight withdrawal is generally undesirable but may be forced by enemy action. It is usually characterized by the forward elements fighting their way to the rear, with units in rear covering their withdrawal and assisting them in breaking contact.

*b.* Mechanization of the company greatly facilitates its accomplishment of this type action.

c. The successful execution of a daylight withdrawal depends to a large extent on effective planning, control, speed of movement, proper use of available firepower, and strong leadership.

d. The battle group order for a daylight withdrawal is frequently fragmentary. It normally prescribes the company zone and/or route(s) of withdrawal, assembly area (if used), and other measures to control movement; positioning of the battle group covering force; attachment of supporting units to the company; sequence of withdrawal; and instructions for occupying subsequent delaying or defensive positions to the rear. The time of withdrawal may or may not be announced initially.

## **177. Planning**

a. Planning is as detailed as time permits. While thorough reconnaissance by all leaders of withdrawal routes, zones, and subsequent positions is desirable, time will normally permit only limited reconnaissance. Reconnaissance parties may be used to reconnoiter successive positions. The company commander issues a fragmentary warning order as soon as possible to permit concurrent planning by his subordinates. Fragmentary orders are issued as plans are formulated.

b. The company commander assigns each forward platoon a zone of withdrawal and a general route of withdrawal to coordinate and control the movement of these platoons. Check points may also be designated. The zones of withdrawal extend as far to the rear as it is anticipated the

platoons will have to move deployed. Usually this is no farther to the rear than the location of the company covering force (company reserve), but may be farther for those platoons whose withdrawal cannot be covered by this force.

*c.* The company commander normally prescribes a platoon assembly area for each forward platoon. Assembly areas for the forward platoons are normally located in defilade to the rear of the company covering force. When the withdrawal of a forward platoon cannot be covered by the company covering force, it may be necessary to locate the assembly area for that platoon to the rear of the battle group covering force. The assembly area for the company covering force is normally located in the company assembly area.

*d.* The company commander designates routes from the platoon assembly areas to the company assembly area or subsequent position, as appropriate. Routes selected should pass around the flanks of units to the rear and should afford as much cover and concealment as possible, consistent with rapidity of movement and the battle group traffic control plan.

*e.* The company commander normally designates the reserve platoon(s) as the company covering force. Elements of this force are located to permit it to cover the withdrawal of all forward platoons. Such action may require splitting a platoon, which in turn will increase the problem of control. If the battle group covering force is located too far to the rear or flank to cover the withdrawal of the company covering

force, the company commander may specify that a forward platoon occupy a position in rear to cover its withdrawal.

*f.* The company commander normally attaches organic weapons and attached elements such as tanks to the platoons in whose areas they are located. Tanks usually join the company covering force as the forward platoons pass, and upon passing through the battle group covering force, may be detached from the company and attached to this covering force.

*g.* Based on the company plan, platoon leaders select routes of withdrawal to their platoon assembly areas. The platoon leader determines the probable order of withdrawal of elements of the platoon, and he may relocate crew-served weapons near the topographical crest to obtain better fields of fire. He may select tentative rallying points along the route of withdrawal. If the platoon must cover its own withdrawal initially, the platoon leader selects one or more subsequent positions to be occupied by the first elements of the platoon to withdraw.

### **178. Utilization of Armored Carriers**

*a.* If the company is completely mechanized, the company commander usually attaches carriers to his subordinate units, including, if possible, elements of the weapons platoon. If only enough carriers are available to carry a portion of the company, the company commander must determine how these vehicles can best be employed to facilitate the accomplishment of the mission.

Often, the available carriers can be utilized most effectively by attaching enough vehicles to each platoon to carry the last elements of the platoon to withdraw. It may be feasible to attach all available carriers to the forward platoons initially, having some of them become attached to the company covering force as the forward platoons pass through this force. Consideration should be given to providing carriers for attached and organic supporting weapons units.

*b.* If possible, carriers occupy hull defilade positions immediately in rear of the platoon position from which they can support by fire the withdrawal and mounting operations. If conditions prevent movement of the carriers to hull defilade, they are moved as far forward as possible to facilitate rapid loading of personnel.

### **179. Conduct**

(fig. 36)

*a.* Depending upon the situation, the battle group commander may order the simultaneous withdrawal of forward companies, or he may order the least engaged forward units to withdraw first. The company initiates the withdrawal only on order. Nuclear and nonnuclear fires and smoke are used. In some situations, a limited objective attack may be made to extricate heavily engaged units. Armed helicopters, if available, may be used to assist in the disengagement of forward units.

*b.* If elements of the company are heavily engaged, the company commander usually orders the withdrawal of the least engaged forward



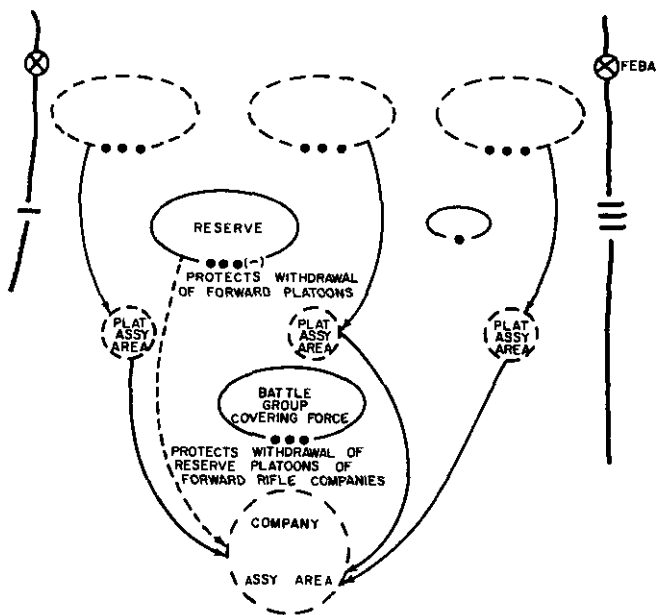

Figure 36. Daylight withdrawal (schematic).

platoons first. He may order the simultaneous withdrawal of all forward platoons if enemy pressure is about equal along the front.

c. The degree of enemy pressure dictates the manner in which the rifle platoon withdraws to the rear of the covering force. A platoon that is not engaged may withdraw as a unit; however, enemy pressure will more frequently require it to withdraw by using fire and maneuver at platoon or squad level. Control of the platoon at all times is essential. When rallying points are deemed necessary to assist in retaining control,

the enemy situation dictates which of the tentative rallying points will be used. The platoon sergeant may withdraw with or prior to the initial elements of the platoon in order to supervise the reestablishment of control of elements of the platoon at the selected rallying point or to supervise occupation of a subsequent position.

*d.* When the platoon withdraws using fire and maneuver, riflemen and certain crew-served weapons are normally withdrawn first, under the protection of automatic weapons and tanks. The action is a thinning out of the position. Automatic weapons and tanks are usually withdrawn last after other elements are far enough to the rear for relative safety. In close terrain, it may be necessary to withdraw tanks earlier. At the rallying point, withdrawing elements pause only long enough to reestablish control; the platoon usually does not assemble until the platoon assembly area or subsequent position is reached.

*e.* Withdrawing units are careful not to mask the fires of covering forces to the rear. Tanks fire on the enemy during their withdrawal; they normally join covering forces on passage of their positions. Platoons assemble at platoon assembly areas (if appropriate) and move immediately to the company assembly area, which is usually in rear of the battle group covering force. After withdrawal of the forward platoons, the company covering force is withdrawn in a similar manner. The 81-mm mortars are normally withdrawn by echelon in order to furnish continuous fire sup-

port when it is necessary for the company to cover its own withdrawal.

*f.* Delay in the company assembly area is avoided if at all possible. Consistent with the battle group traffic control plan, platoons may be dispatched to the rear individually upon arrival at the company assembly area.

## **Section IV. DELAYING ACTIONS**

### **180. General**

*a.* A delaying action is an operation in which a unit trades space for time and inflicts maximum casualties on the enemy without becoming decisively engaged in combat. This is the underlying principle of a delaying action—to gain time without fighting a decisive engagement. In addition, efforts are made to force the enemy to mass, thus presenting a nuclear target. While conducting a delaying action, a company may be forced to fight a decisive engagement. This may be necessary because of a local tactical situation, such as limited space and time requirements, or such action may be initiated on order of higher command.

*b.* The echelons of a delaying force consist of a security echelon, forward forces, and a reserve. A rifle company may occupy the forward area, provide all or part of the security force, or it may be part of the battle group reserve. When extreme frontages have been assigned, the battle group reserve may furnish the security echelon.

*c.* A delaying mission may direct the holding of enemy forces beyond a definite line until a stated time. The reason is normally announced. The delay may be accomplished by the occupation of a single position or of successive positions, utilizing obstacles and employing maximum fires at long ranges.

*d.* During the conduct of the delaying action, contact is maintained with the enemy. Maximum delaying is accomplished between, as well as on, successive positions. Forward forces, upon withdrawal from initial delay positions, effect maximum delay forward of covering forces located to the rear by fighting from one or more successive positions and by utilizing prepared obstacles to the maximum. A mechanized force possesses a greater capability of effecting continuous delay than does a dismounted force.

### **181. Desirable Characteristics of Terrain for Delaying Positions**

*a.* Good observation and long fields of fire. The use of topographical crests may facilitate the development of long-range fires; if a long delay on one position is required, consideration should be given to organization near the military crest.

*b.* Concealed routes of withdrawal.

*c.* Obstacles to the front and flanks.

*d.* Maximum concealment for the forces on the delaying position.

*e.* A series of parallel ridges across the lines of hostile advance.

## **182. Organization of Delaying Positions**

*a.* The battle group commander normally assigns the company a delaying position initially, and a zone of withdrawal which becomes effective on order. Frontages assigned to the companies are usually greater than those assigned in a defensive situation. Often the company commander will be required to use four platoons forward to cover the assigned frontage adequately. He retains a reserve if possible to provide flexibility and depth. The company organizes this extended frontage by accepting larger gaps between platoons. The area physically occupied by platoons is not increased over the maximum figure for defense. The company commander makes plans to cover the gaps between platoons by the use of patrols, fires, observation, and obstacles.

*b.* The company commander designates platoon areas as he would in the defense (par. 131); however, platoon positions are normally selected on or near the topographical crest to provide long-range fires and observation and to facilitate withdrawal. The company organizes the ground as completely as time permits. It takes advantage of natural obstacles to the front and flanks, and increases their effectiveness by supplementing them with artificial obstacles.

*c.* To facilitate control, weapons (such as tanks and 106-mm rifles) are usually attached to the rifle platoon in whose area they are located. The 81-mm mortars are employed to cover the front and are placed well forward to obtain maximum range. If the front cannot be adequately covered

from a central location, the mortars may be attached to rifle platoons as required. The rifle platoon leaders locate organic and attached weapons where they can obtain long-range fields of fire.

d. The company commander normally prescribes platoon zones of withdrawal (par. 177). He designates subsequent platoon delaying positions, platoon assembly areas, and routes of withdrawal, as appropriate. If the assigned frontage permits the retention of a reserve, the reserve is utilized as the company covering force and is positioned to permit it to cover the withdrawal of all forward platoons, if possible. Depending on the location of the battle group reserve, the company commander may specify subsequent platoon delaying positions in rear of the initial position(s) of the company reserve. When the assigned frontage requires the use of four platoons forward, the company commander designates subsequent delaying positions as necessary to coordinate the action of the company during the conduct of the delay. Delaying positions selected block critical approaches and take advantage of natural and artificial obstacles.

e. Platoon leaders select positions within their assigned zones from which delay can be effected between designated successive positions. These selected positions are generally located so that the first elements of the platoon to withdraw from one position can occupy the next position to the rear to cover the withdrawal of the remainder of the platoon. Consideration is given to locating

these positions so that obstacles can be covered by fire.

*f.* Zones of withdrawal and subsequent positions are reconnoitered as time permits. If possible, preparation of subsequent positions is begun prior to the beginning of the delaying action. If time is limited, reconnaissance parties are used to prepare plans for occupation of these positions.

### **183. Utilization of Armored Carriers**

*a.* The utilization of armored carriers in a delaying action is similar to their use in a daylight withdrawal (par. 178).

*b.* When the company furnishes security elements forward of the delaying position, the company commander normally attaches carriers to those elements. Other security detachments, such as flank security elements, should receive high priority in the attachment of carriers. The use of the remaining carriers must be based upon the existing situation and the plan for the conduct of the delay. The company commander may attach some carriers to each platoon in order to permit the mounting of the last elements of the platoon to withdraw. When it appears that one or two platoons may become more heavily engaged than others, he may provide complete mobility for those platoons. In some situations, it may be possible to shuttle platoons to subsequent delaying positions in the rear, though this method will often be impractical.

## 184. Conduct

*a.* Permission to withdraw forward forces from a battle group delaying position must normally be obtained from the battle group commander. Consequently, the company commander must keep the battle group commander informed of the situation at all times to prevent forward platoons from becoming so heavily engaged that they cannot be withdrawn effectively. If communication with the battle group commander is lost, the company commander makes the decision based primarily on his assigned mission, the overall concept of the operation, and the enemy situation.

*b.* The enemy is engaged by fire at long ranges. Every effort is made to force him to deploy in order to effect maximum delay. Normally forward forces are withdrawn, on order, before they become engaged in close combat. The withdrawal is generally conducted using daylight withdrawal techniques (pars. 176-179). However, conditions may permit use of night withdrawal techniques (pars. 171-175).

*c.* When the delay is to be achieved by a defense of an area for a specified period of time, the conduct of the action prior to the withdrawal is as discussed in section IV, chapter 4.

*d.* Upon withdrawal from initial positions, platoons effect maximum delay in their assigned zones. The first elements of the platoon to withdraw move rapidly to and occupy the next position to the rear. Normally the platoon sergeant supervises this action. These elements cover the



withdrawal of the remainder of the platoon. As the last elements withdraw, they execute previously prepared demolitions or other obstacles. The withdrawing elements of the platoon may join those elements already in position, or a portion of the platoon may be leapfrogged to the next position to the rear. The platoon leader normally remains with the forward portion of the platoon in such a case. Maximum delay of the enemy is accomplished at each position consistent with avoiding close combat. The platoon fights to the rear in this manner until the covering force of a higher unit is passed, after which the platoon may assemble to continue its movement to the company assembly area or a subsequent position, as appropriate.

*e.* The company commander coordinates the actions of his withdrawing platoons. Consistent with instructions from the battle group commander, he orders the withdrawal of forward platoons to prevent them from being cut off by a rapidly advancing enemy force to the flanks of these elements. If a reserve is available, he repositions the reserve to block enemy penetrations and protect the flanks and rear. He utilizes patrols to maintain contact with adjacent units, provide flank security, and block enemy threats from the flanks.

*f.* Should the enemy withdraw from the attack, contact is maintained and forward positions are reoccupied if possible. Such action reduces the enemy's ability to place nuclear fires on the forward forces.

## CHAPTER 6

# AIRBORNE OPERATIONS

---

### Section I. GENERAL

#### 185. General

*a.* This chapter covers the tactical employment of the rifle company of either the infantry division battle group or airborne division battle group in the airborne assault, and withdrawal by air. Both companies have the capability of participating as an air-landed force, while the rifle company, airborne division battle group, has the additional capability of entering combat by parachute.

*b.* For a general discussion of airborne operations, primarily concerning operations using Air Force aircraft, see FM 57-30. For a discussion of the airborne division battle group, see changes to FM 7-40 when published. For a discussion of airborne operations using Army aircraft (primarily helicopters), see FM 57-35.

#### 186. Tactical Employment

*a.* In airborne operations, the rifle company normally fights as part of the battle group, either under direct control of the battle group com-

mander, or as a task force, or part of a task force within the battle group. Because of the dispersion of elements of the battle group necessary to reduce vulnerability to nuclear attack, independent or semi-independent operations by the company during all or part of the operation will not be unusual.

*b.* The rifle company can land in unprepared areas on any terrain that is relatively free from obstacles that are dangerous to parachutists, assault aircraft, or transport helicopters, depending on the delivery means used. The assault landing can be made during daylight or at night. The company can fight immediately upon landing; however, it can fight most effectively after a time interval that permits it to assemble as a tactical unit under control of the company commander. This time interval is normally greater in parachute operations than in air-landed operations.

*c.* After an airborne assault landing, the rifle company operates tactically in substantially the same manner as discussed in previous chapters. Following the assault phase, in which initial objectives are seized, the company may defend until link-up with friendly ground forces, until a buildup of forces by aerial delivery permits resumption of the offensive, or until withdrawal. In some situations, offensive operations may be continued immediately after the assault phase, with a subsequent link-up or withdrawal.

## Section II. AIRBORNE ASSAULT

### 187. Preparation for the Airborne Assault

*a.* Airborne operations require detailed planning at all levels and close coordination with transporting aviation units. For coordination, the company commander usually participates in the detailed planning of the next higher headquarters. The time available for preparing for an airborne operation may vary from a few hours to several days.

*b.* The company must maintain the maximum possible readiness to launch an airborne assault on short notice. The following measures may be taken to maintain readiness, depending on the imminence of an operation:

- (1) Fit personnel parachutes, tag them, and prepare them for movement to loading site (parachute operations only).
- (2) Prepare supplies and equipment for aerial delivery (parachute operations only).
- (3) Issue supplies and equipment to individuals.
- (4) Maintain up-to-date SOP loading tables that are readily adaptable to probable methods of employment.
- (5) Conduct frequent inspections, checks, and training exercises.

*c.* For a detailed explanation of loading forms for airborne operations in which Air Force aircraft are used, see FM 57-30; for operations in which Army aircraft are used, see FM 57-35.

Loading forms are completed to the extent practicable prior to receiving the warning order for a mission.

### **188. Battle Group Orders**

a. The company commander usually receives a warning order early in the planning phase so that his company can prepare for the operation concurrently with the development of detailed plans by the battle group commander and staff. In addition to information normally included in a warning order for an attack, the battle group warning order usually includes special security measures, information on the number and types of aircraft allocated to the company, equipment to be delivered with the assault echelon, instructions on preparation of equipment for aerial delivery, and any required changes to SOP loading plans. The need for security may require withholding specific information concerning the operation until the marshaling phase begins.

b. The battle group order gives the rifle company its mission and designates the supporting and attached units. When task forces are employed, the battle group order specifies their composition and missions. The mission of the rifle company for the assault phase is assigned in a manner similar to that for any other attack. In addition, the battle group plans and orders may include—

- (1) The location of drop zones, landing zones, or landing sites for elements of the battle group, as appropriate.

- (2) The plan for reorganization after landing, including location of company assembly areas, use of assembly aids, method of collecting stragglers, reports, and security measures. When elements of the battle group are to land in widely dispersed areas, the selection of company assembly areas may be delegated to the company commanders.
- (3) Data on the air movement, including location of loading areas, allocation of aircraft, composition of the aircraft serials, and the times for loading, take-off, and arrival at the objective area.
- (4) Data on marshaling. This may be issued in a separate order if lengthy and detailed.
- (5) Plan for reconnaissance after the landing, including reconnaissance for radiological contamination.
- (6) Plans for defense of the airhead after seizure of initial objectives, when applicable.
- (7) Plans for link-up with surface forces, if appropriate.
- (8) Details of air-sea rescue, when applicable.
- (9) Details of time and place of arrival and the use of troops and equipment in the followup echelon, when applicable.
- (10) Organization of, and instructions to, the rear echelon.
- (11) Supply and evacuation plan, including

the method of recovering supplies and special measures for air resupply and air evacuation.

(12) Alternate plans for accomplishing the mission.

(13) Plans for other subsequent operations.

### **189. Reconnaissance**

An aerial reconnaissance of the objective and the routes to the objective area should be made by the company commander whenever conditions permit. If an aerial reconnaissance is not possible, his reconnaissance consists of a study of maps, terrain models, and photographs of the objective area. Other information of the terrain and enemy may be available from higher headquarters. In addition to information of the enemy and terrain sought for ground operations, the following items are important in an airborne assault for the formulation of the ground tactical plan and landing and reorganization plans:

*a.* Nature of landing zones, drop zone, and/or landing sites, as appropriate; to include anti-airborne obstacles.

*b.* Nature of assembly area(s).

*c.* Location of critical areas held by the enemy in or near the company's area of operations.

*d.* Location and types of obstacles in the area of operations.

*e.* Nature of the objective, and location of suitable terrain for defense of the objective

*f.* Presence of enemy armor.

## 190. Tactical Planning

Based on battle group plans and orders, the company commander prepares his plans for loading, air movement, landing and reorganization, and the accomplishment of the tactical mission. In operations using Air Force aircraft, the marshaling plan (par. 195) is considered along with the loading plan. Normally the ground tactical plan is prepared first. Based on this plan, the landing and reorganization plans are prepared, followed by the preparation of plans for air movement, loading, and marshaling, in that order. Although planning follows this general sequence, all plans are closely interrelated and are often developed concurrently.

## 191. Organization for Combat

The company may be reinforced, particularly if it has a separate or independent mission after landing. Attachments are made early during marshaling in order to give the company commander time to coordinate the use of his attached units and to control their preparations for air movement and subsequent action. In organizing for combat, the company may be divided into assault, followup, and rear echelons.

*a. The assault echelon* of the company consists of the troops and equipment landed to seize the company objective(s). The personnel and equipment of the company included in the assault echelon may be limited by the availability of aircraft.

*b. The followup echelon* is the combat portion



of the company that is not included in the assault echelon because of aircraft restrictions or the tactical situation. This echelon joins the assault echelon as soon as possible after the airhead is established or after link-up.

*c. The rear echelon* includes any portion of the company that is not needed for combat. The rear echelon may include personnel who are temporarily disqualified physically, the company kitchen, and mess personnel. It normally operates under the control of battle group or higher headquarters.

## **192. Ground Tactical Plan**

*a. General.* The ground tactical plan includes the plan of attack to seize assigned objectives, plan for defense of the assigned portion of the airhead, plan for subsequent offensive operations, and plan for withdrawal, as appropriate. Plans should be simple and should be flexible enough to permit alteration to meet unforeseen situations. Alternate plans are prepared. Plans of attack and defense are generally as described in chapters 3 and 4, modified by the following factors peculiar to the airborne assault:

- (1) The possibility of becoming engaged immediately upon landing, before assembly and recovery of parachute-delivered equipment is completed.
- (2) Limited artillery support. The company may have to attack before light artillery and, in some cases, the mortar battery have occupied firing positions.

The dispersion of units in the airhead may limit the amount of artillery fire support which can be furnished the company.

- (3) Greater separation of units, resulting in more exposed flanks and rear.
- (4) Limitations on available ammunition and other supplies.
- (5) Limited mobility.
- (6) Nonavailability of tanks.
- (7) Confused tactical situation, with both friendly and enemy forces lacking information of the other.
- (8) Enemy normally surprised initially.
- (9) The objective area often relatively free of prepared enemy defenses and may not contain well-organized enemy combat troops initially.
- (10) Loss of a portion of company elements because of inaccurate aerial delivery or loss of aircraft prior to landing.

*b. Plan of Attack (fig. 37).*

- (1) The plan of attack is designed to capitalize on surprise achieved by the assault landing through rapid seizure of the assigned objective(s) before the enemy has time to react effectively. In addition to the seizure of the assigned objective, the plan of attack provides for clearing the assigned sector of responsibility of effective enemy resistance when such action is directed. Normally in the parachute assault, the company as-

sembles and reorganizes in its assembly area and attacks to seize its objective immediately. In air-landed operations, the assembly and reorganization of the company may not be necessary. An attack position and line of departure are seldom utilized. Platoon objectives are selected to insure seizure and control of the assigned objective(s) and to accomplish other missions. Normally intermediate objectives are not assigned because of the usual proximity of the company to its objective upon landing and the desire for speed in seizure of the objective. Whenever possible, a reserve is retained in the initial attack to provide a means of influencing the action; however, retention of a reserve may not be possible if a number of objectives must be seized simultaneously.

- (2) When the company is assigned more than one objective, alternate plans may be prepared to provide for seizure of the objectives either simultaneously or in succession, as indicated by the enemy situation at the time of attack. Simultaneous seizure of objectives may be possible if they are lightly held, which would result in greater speed in accomplishing the mission. Conversely, seizure of well-defended objectives in succession may be necessary to permit concentration of the combat power of

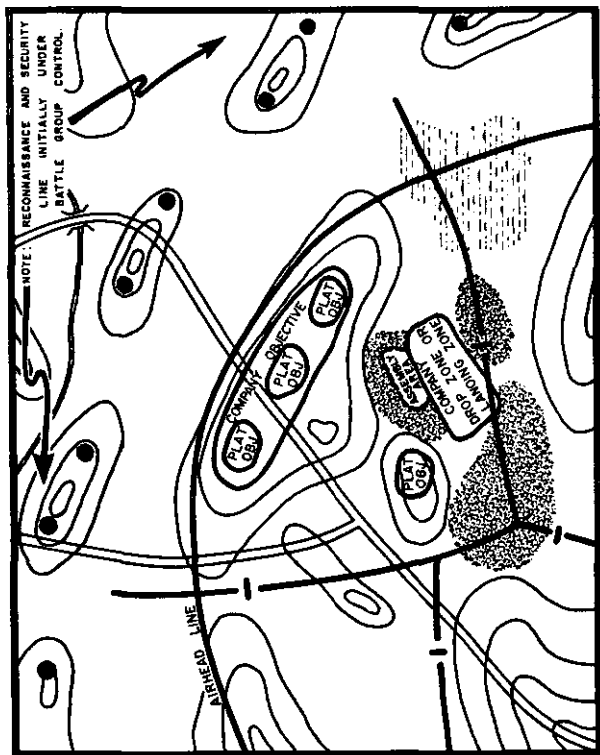

Figure 37. Rifle company in air-landed or parachute assault (schematic).

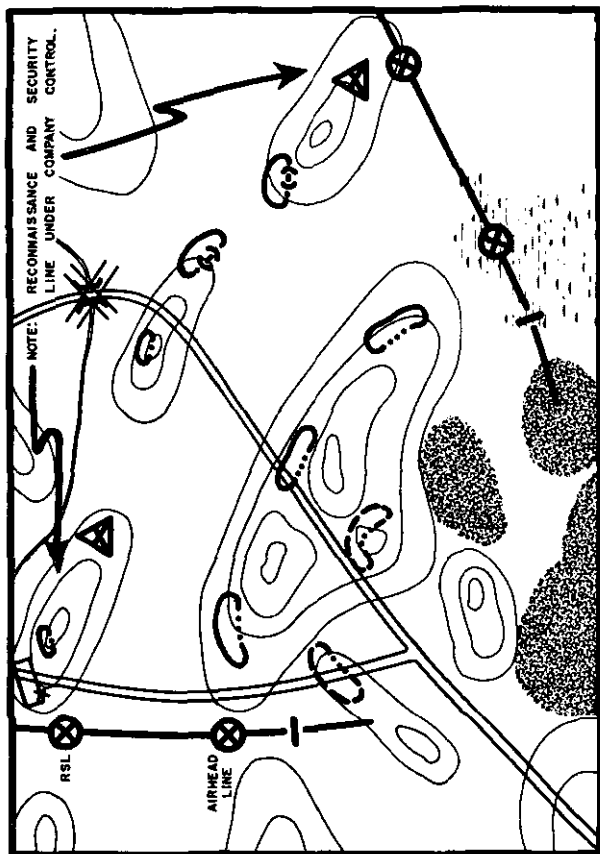

Figure 38. Rifle company in defense of airhead (schematic).

the company against one objective at a time.

*c. Plan of Defense* (fig. 38). When the operation contains a defensive phase, the company is normally assigned a portion of the airhead line to defend. The company defensive area is designated by boundaries and the portion of the airhead line between limiting points. In addition, the company will often be assigned responsibility for establishing the RSL. The organization of the defense is similar to that discussed in chapter 4. Because the area to defend will frequently be large, mutual support between platoons and companies may be limited. Platoons are located to protect critical terrain and cover the most likely avenues of approach into the company sector of responsibility (par. 201).

*d. Withdrawal.* When the plan of operations calls for a withdrawal subsequent to the assault phase, plans are formulated in as much detail as possible prior to the operation. For a discussion of the withdrawal by air, see paragraphs 202 through 207.

### **193. Landing and Reorganization Plans**

*a.* The drop zone(s), landing zone(s), or landing site(s) (as appropriate) to be used by the company or its elements, are normally specified by the battle group commander. The company commander may assist in the selection of these areas which will best conform to his ground tactical plan. As a general rule, drop or landing zones, or landing sites, are selected as close

to the objective as the terrain and enemy situation permit. See changes to FM 7-40 when published.

b. In an air-landed operation, a company assembly area may not be necessary; in a parachute operation, an assembly area is normally required. When used, the company assembly area is normally selected by the battle group commander when coordination in the assembly of companies is required, such as when more than one company lands on one landing zone or drop zone or when landing sites are close together. When elements of the battle group land in widely separated areas, the selection of the company assembly area is often delegated to the company commander. One company assembly area is normally selected; however, one or more separate platoon assembly areas may be selected when the ground tactical plan so indicates. Alternate assembly areas are selected for use in case of unexpected enemy action. In selecting the assembly area, the company commander strives to choose an area which—

- (1) Is free from enemy troops and small-arms fire.
- (2) Is as close as possible to drop or landing zones or landing sites.
- (3) Offers good cover and concealment.
- (4) Permits units to assemble in areas where they are favorably disposed for the attack, to include proximity of weapons to initial firing positions.
- (5) Permits units to assemble in the direc-

tion of their objectives.

- (6) Is large enough to accommodate the company.
- (7) Is easily identifiable by prominent landmarks.

c. The use of certain assembly aids may be specified by battle group. The company commander specifies use of such other aids as are desirable for rapid assembly, provided their use is not restricted by higher headquarters. Since the assembly and reorganization of the company is a critical period, security may be sacrificed to a degree in the use of assembly aids to provide speed in assembly and reorganization. Aids which may be used include: panels, flags, colored smoke, and pyrotechnics to mark the assembly area during daylight; lights, pyrotechnics and infrared devices to mark the assembly area at night; guides near the assembly area; radio homing devices; audible signals such as tin crickets and whistles; and distinctive markings to identify personnel and equipment of particular units. While the use of such aids will facilitate assembly and reorganization, the most important step which can be taken to assure success of this phase is the thorough orientation of personnel on the assembly plan.

d. The company commander plans for necessary security of the assembly area during reorganization.

#### **194. Air Movement Planning**

a. Air movement planning at company level consists essentially of preparing air loading tables



and flight manifests. The air loading table prepared by the company is forwarded to battle group for inclusion in the battle group air loading table. For preparation of the air loading tables and flight manifests, see FM 57-30 and FM 57-35.

*b.* In preparing the air loading table, tactical integrity of squads and platoons is maintained to the maximum extent possible. Critical command personnel, weapons, and communication equipment are distributed among several aircraft. Weapons and their crews are loaded in the same aircraft. Personnel to recover equipment bundles upon landing are designated. For loading of accompanying supplies, see chapter 7. In air-landed operations, enough men are placed in each aircraft to unload cargo upon arrival at the destination.

## **195. Marshaling**

*a. General.* Marshaling is a process used to complete final preparations for combat, move to departure airfields or air-landing facilities, and load for takeoff. It applies to operations in which Air Force aircraft are used for movement. When Army aircraft are used, the same general procedures are followed by the rifle company in preparing for the operation; however, in this case the aircraft normally come to the company area for loading, and consequently the company assembly or bivouac area is, in effect, the marshaling area. When marshaling begins, units are sealed in their assembly areas, and strict security is imposed. Marshaling is accomplished in the

shortest time possible, usually less than 48 hours. Preparations are completed which could not be accomplished prior to marshaling, to include finalization of plans, briefing of troops, and final preparation of supplies and equipment for aerial delivery.

*b. Briefing.* All troops are briefed in as much detail as time permits. Briefings are usually conducted at company, platoon, and squad level, using techniques described in FM 57-30. Personnel briefings stress the reorganization plan because of its importance in regaining control after landing in the airhead. Through use of terrain models, aerial photographs, and maps, all personnel are thoroughly familiarized with the area of operations to permit their rapid orientation upon landing. The briefings include plans of the battle group and the other companies involved in the operation so that in the event of inaccurate landings or unforeseen resistance, elements of the company may contribute to the accomplishment of the overall mission. Security is emphasized to prevent individuals from carrying copies of battle plans and orders into the objective area where subsequent capture might compromise operations.

*c. Preparation of Equipment for Aerial Delivery.* For parachute operations, the preparation of accompanying supplies and equipment for aerial delivery is completed during marshaling. Aerial delivery containers, cargo parachutes, and related equipment are issued to elements of the company for the packing of equipment which is

to be carried on individuals, delivered as door bundles, and dropped by monorail. Packing of this equipment is accomplished in the company assembly area by company personnel. Bundles are distinctively marked to facilitate recovery. Items to be delivered by heavy drop are normally prepared by personnel of the company under supervision of trained teams from higher headquarters. Rigging of this equipment is normally conducted near the loading site at times designated by higher headquarters. For a general discussion of rigging door bundles and loads for aerial delivery, see FM 57-30 and FM 57-100. Quartermaster Technical Bulletins and Technical Manuals of the 10-500-series contain specific data on rigging for aerial delivery of all vehicles, major weapons, and bulk equipment.

*d. Loading of Equipment.* The company commander is responsible for loading his personnel, supplies, and equipment in accordance with the battle group loading plan. The company normally loads and lashes its supplies and equipment in aircraft early, and loads troops at the last possible moment. Aircraft crews supervise and provide technical assistance in the lashing of equipment. After the aircraft is loaded, the pilot and the load commander conduct an inspection.

*e. Loading of Troops.* The company moves to designated loading sites according to the battle group plan. Troops move from the assembly area by plane load. Upon arriving at the loading site, each plane load moves directly to its assigned aircraft and boards.

## **196. Responsibility During Air Movement**

When the air movement is made by Air Force aircraft, the commander of the transporting aviation unit controls the air movement from the point of departure to the drop or landing zones. During this movement, the pilot is the aircraft commander and is in absolute charge of his aircraft, all crew members, and all passengers aboard. When the movement is made by Army aircraft, the air movement is controlled by the commander specified in the battle group order. The pilot, as commander of the individual aircraft, is responsible for the safety of the aircraft, crew members, and passengers.

## **197. Landing**

*a.* When the company is to be immediately employed, the company lands on or as close as possible to its objective to achieve maximum surprise and to prevent unnecessary movement of troops, supplies, and equipment. Landing directly on the objective is desirable when it is undefended; however, when it is defended the problems of reorganization and control are increased. The company usually lands on a single drop or landing zone.

*b.* In parachute operations, equipment and supplies delivered by heavy drop will normally land on the same drop zone as that used by the company; however, in some situations a different drop zone may have to be used for this equipment. Personnel to recover the equipment delivered by

heavy drop land as near their equipment as possible.

### **198. Assembly and Reorganization**

*a.* The assembly and reorganization during the initial assault are critical periods because of the vulnerability of the company to enemy attack. These operations are executed with maximum speed and precision. When necessary, security is sacrificed for speed and control.

*b.* When the company lands directly on or immediately adjacent to its initial objective(s), an assembly area is not normally used. Squads, platoons, and special teams proceed to their objectives immediately. In this type of assault, reorganization is accomplished concurrently with, or immediately after, seizure of initial objectives.

*c.* When an assembly area is designated, individuals move directly to it. No attempt is made to assemble units on the drop zone or landing zone. In parachute operations, personnel designated to recover supplies and equipment do so immediately and move to the designated assembly area. Radios are put into operation without delay.

*d.* If the company is engaged on the drop zone or landing zone, individuals return fire immediately. Leaders assume control of groups of individuals, regardless of unit, and attempt to eliminate the enemy force by small unit action. Aggressiveness is necessary in regaining control of individuals and in attacking the enemy force without hesitation.

*e.* Assembly aids are utilized as planned. If enemy action so requires, aids are set up to direct individuals to an alternate assembly area. Guides near the entrance to the assembly area direct individuals to their respective unit areas. Security is posted as planned.

*f.* Communication is established with battle group and within the company. Subordinate leaders keep the company commander informed of the status of their units during assembly and reorganization.

*g.* If elements of the company land in the wrong area, they are assembled under the senior officer or noncommissioned officer present. If possible, he immediately establishes communication with the appropriate commander and requests instructions. Lacking orders, the group directs its effort toward accomplishing the general mission. Individual stragglers join the nearest unit and rejoin their own units as soon as the situation permits.

### **199. Initiation of the Attack**

*a.* As soon as possible after landing, the company commander dispatches patrols to reconnoiter the objective. Based on information of the enemy reported by these patrols, the company commander determines the extent of reorganization required before the attack is launched. Because of the surprise inherent in the airborne assault, it will frequently be more desirable to initiate the attack early, when only a portion of the company has been assembled, than to delay

the attack pending assembly of the majority of the company. When patrol reports indicate that the enemy is prepared to defend the objective, more complete assembly of the company prior to the attack is indicated. The decision to initiate the attack is normally delegated to the company commander; however, in some situations, the battle group commander may make this decision in order to coordinate the action of the battle group.

b. When the company is assigned responsibility for establishing a portion of the RSL during the assault phase, elements to establish this line either land on or near the RSL or move forward to this line as soon as possible. The primary mission of these elements during the assault is to provide early warning of enemy approaching the airhead. See paragraphs 127 and 201a.

## **200. Conduct of the Attack**

The conduct of the attack is generally as described in chapter 3. Based on the degree of assembly of the company and on newly acquired information of the enemy and terrain, the original plan of attack is modified by the company commander. Aggressiveness and rapidity of movement are necessary to capitalize on the surprise achieved by the airborne assault. Upon seizure of initial objectives, elements of the company redispense themselves to defend the airhead line or take such other action as is indicated by the assigned mission. Dispersion of elements of the

company is necessary to reduce vulnerability to nuclear attack.

### **201. Subsequent Operations**

*a.* When the assault phase is followed by a defense of the airhead, the company normally defends a portion of the airhead line. Required dispersion may result in reduced mutual support between companies and between platoons. An RSL is normally established forward of the airhead line by forces which either land on or near the RSL or which move forward to this line from the airhead line. During the defense, the responsibility for the RSL is normally assigned to forward companies. Antitank defense of the airhead is emphasized. For organization and conduct of the defense, see chapter 4.

*b.* When the ground forces are to accomplish a link-up in or near the company's sector of the airhead, the company commander insures that coordination measures are disseminated to and observed by members of the company. Such measures may include coordination of plans of maneuver, coordination of fires, mutual recognition, and coordination of communications.

*c.* Subsequent offensive action after the assault phase is conducted as described in chapter 3.

*d.* For a discussion of withdrawal from the airhead, see paragraphs 166 through 184 and 202 through 207.

### **Section III. WITHDRAWAL BY AIR**

#### **202. General**

*a.* A withdrawal by air is an operation in which all or part of a deployed force disengages



from the enemy and moves by aircraft to another location. It may be made voluntarily, or it may be forced by enemy action. A withdrawal by air from an airhead may be preplanned during the planning phase for execution when the airborne mission has been completed, or it may be executed as a result of a change in the original plan or when forced by the enemy. It may be conducted during daylight or at night. The rifle company executes a withdrawal by air when operating as part of a larger force, or in the conduct of an independent operation, such as an airborne raid. In the latter situation, the tactics and techniques described below are modified to conform to existing conditions.

*b.* Air superiority is normally required for a successful withdrawal by air. In some situations, small forces may be withdrawn over short distances without air superiority when adequate fire support is available from outside the airhead.

*c.* Forces withdrawn by air normally move to assembly areas behind friendly lines. In some situations, the forces may be moved to another objective area or battle area.

### **203. Concept**

*a.* In order to effect withdrawal of the majority of the force from the airhead, a portion of the force is required to cover the withdrawal of the main body from contact, its movement to loading areas, and its evacuation. Normally, least engaged units are withdrawn and evacuated first, under protection of detachments left in contact.

After evacuation of the main body, the detachments left in contact break contact with the enemy and are evacuated, preferably by helicopter.

b. The composition of the detachments left in contact and the specific techniques used in covering the withdrawal will vary widely, depending upon such factors as: enemy pressure and capabilities; fire support available; terrain; size of the airhead; availability of aircraft and landing facilities; conditions of visibility; and friendly air cover available. In some situations, such as when enemy pressure is light and his capabilities are limited, relatively light detachments left in contact may be adequate. In other situations, strong forces may be required to withstand determined attacks delivered to disrupt the operation. The composition and strength of detachments left in contact may also vary in different portions of the airhead.

c. Every effort is made to withdraw all personnel and equipment by air. However, enemy action will often prevent withdrawal of a portion of the detachments left in contact. These forces utilize evasion and infiltration tactics to return to friendly lines or to meet aircraft at other locations. Equipment which cannot be evacuated is destroyed.

## **204. Plans**

a. The company plan of withdrawal is based on plans or orders from battle group. These plans include composition of the main body and

detachments left in contact; control and coordination measures, to include time and sequence for withdrawal of various elements, zones and/or routes of withdrawal, check points, phase lines, assembly areas, loading areas, and loading control measures; coordination of fire support; communication instructions; secrecy and deception measures; and actions upon arrival in the new area.

b. Plans for the withdrawal are as detailed as time permits. Because the tactical situation at the time of withdrawal cannot be accurately predicted during the planning phase, plans must be flexible enough to permit adjustment necessitated by unexpected enemy reaction, changes in aircraft availability, and similar contingencies.

c. Planning time may be reduced and greater efficiency achieved by including certain procedures in unit SOP's. Such items may include special communication measures, instructions for destruction of equipment, procedures and control for aircraft loading, security measures, type aircraft loading plans, and general plans for evacuation of casualties. When the possibility of withdrawal by air is foreseen prior to an airborne operation, withdrawal plans are included in the plan for the operation. These plans are revised as necessary and kept current during operations in the airhead.

## **205. Reconnaissance**

Detailed ground reconnaissance of assembly areas, routes or zones of withdrawal, and loading

areas is highly desirable. Reconnaissance is conducted by leaders down to the lowest level practicable. Guides are oriented and, when appropriate, routes are marked.

## **206. Organization for the Withdrawal**

*a.* The battle group commander normally specifies the general strength and composition of the detachments left in contact. In some situations, the company may be required to leave only a small number of security posts, while in other situations the entire company may be required to cover the withdrawal of other elements of the battle group.

*b.* All or part of the company may be designated as battle group reserve and assigned blocking or counterattacking missions to assist the withdrawal.

## **207. Conduct of the Withdrawal**

*a. General.* The battle group commander orders the withdrawal. Normally, least engaged units are withdrawn first. The battle group commander controls the withdrawal of elements of the battle group to prevent congestion in the aircraft loading areas and to insure that adequate forces are covering the withdrawal. The withdrawal of various elements is timed so that units move to loading areas and board aircraft with a minimum of delay in assembly areas.

*b. Techniques.* The specific techniques of withdrawal used by elements of the company will vary.

(1) Under certain conditions, the company

may use essentially the night withdrawal technique (sec. II, ch. 5). This technique may be appropriate when the company is not under direct enemy pressure; a degree of deception is possible, as when the company is one of the first units to withdraw; or the company sector is protected by a formidable obstacle or series of obstacles which restrict enemy movement into the area. The company detachments left in contact usually consist of elements of each platoon, which redispense themselves as necessary to cover the major approaches into the company area. Elements of the main body of the company withdraw simultaneously as described for the night withdrawal. If this technique is used during daylight, smoke may be used to deny the enemy observation.

- (2) Under certain conditions, the company may use essentially the daylight withdrawal technique (pars. 176-179). This technique is normally required when the company is under enemy pressure. The company reserve is redispensed as necessary to cover the withdrawal of the forward platoons. If the company has no reserve, elements of the battle group reserve may cover its withdrawal.
- (3) A modified version of the daylight withdrawal technique may be required when the company is under pressure; when

there is no company reserve to cover the withdrawal of the forward platoons; and when no elements of the battle group reserve are in position to cover the withdrawal of the company. Such conditions may exist when the company is among the last elements to be withdrawn from the airhead. Under these circumstances, the company plan of withdrawal will normally provide for the formation of company detachments left in contact. This force will normally be formed along a designated phase line by elements of each platoon. The company commander controls the withdrawal of the platoons based on enemy pressure and the availability of aircraft. He normally orders the least engaged platoon to withdraw first. The first elements of each platoon to withdraw occupy a position to the rear from which they can cover by fire the withdrawal of the remainder of the platoon. This platoon force, which is normally not larger than a reinforced squad, remains in its covering position and becomes part of the company detachments left in contact under company control, while the remainder of the platoon continues its withdrawal to the assembly area. The platoon radio on the company command net normally remains with the platoon detachments left in contact. When the major ele-

ments of all platoons have broken contact and withdrawn, the company commander relinquishes control of the company detachments left in contact to a designated subordinate leader, who, in turn, comes under battle group control.

*c. Security.* The company detachments left in contact provide the primary security for the company's withdrawal. The company commander specifies additional security measures to be taken during movement to and occupation of the company assembly area.

*d. Control of Movement and Loading.*

- (1) The company assembly area for the withdrawal is prescribed by battle group if more than one element of the battle group is to be evacuated from one air-landing facility. If the company is to be evacuated independently, the company commander selects the assembly area and advises the battle group commander of its location. The assembly area is normally adjacent to the air-landing facility. The company commander prescribes platoon assembly areas, routes and/or zones of withdrawal, phase lines, check points, use of guides, and other appropriate control measures. See chapter 5.
- (2) The schedule for loading aircraft is controlled by battle group or higher headquarters. Normally the company

commander designates the executive officer or other representative to control and expedite the loading of the company in coordination with the loading control officer of higher headquarters. The executive officer or other representative is located in the company assembly area. As elements of the company arrive, he insures that they are organized into plane loads, and he dispatches them to aircraft on instructions from the loading control officer. So far as possible, each plane load of personnel and equipment is organized and ready for loading prior to arrival of its scheduled aircraft to minimize the time the aircraft must remain on the ground. When the enemy situation permits, teams may be designated to load and secure equipment in aircraft. When enemy pressure precludes use of such teams, the crew which operates each item of equipment normally loads and secures it and is evacuated in that aircraft with the equipment.

*e. Action of Detachments Left in Contact.* The commander of the detachments left in contact comes under control of battle group. The actions of the detachments left in contact are coordinated by battle group to provide necessary protection for the withdrawal of the main body. Because of the limited amount of space available within the airhead, the detachments left in contact normally defend in place; however, limited delaying



action may be conducted in some situations. The detachments left in contact take maximum advantage of all available obstacles and fires to withstand attack. After the withdrawal of the main body is complete, the detachments left in contact are withdrawn and evacuated by available means. Aircraft (preferably helicopters) pick up elements of this force as near to their positions as possible. In the event that conditions prevent the withdrawal of these forces by air, they break contact with the enemy and use evasion and infiltration tactics to return to friendly lines or to meet aircraft at predesignated points for aerial evacuation.

# CHAPTER 7

## ADMINISTRATION AND LOGISTICS

---

### Section I. PERSONNEL MANAGEMENT AND ADMINISTRATION

#### 208. General

*a.* The company commander is responsible for the administration and logistical functions of the company. These functions are vital to efficient operation and require continuous attention if optimum results are to be achieved. The company commander utilizes and actively supervises selected subordinates in the accomplishment of these functions and requests assistance from battle group when required. The company commander's principal assistant in the supervision of administration and logistics is the executive officer.

*b.* The procedures described in this chapter are intended as a guide and are subject to modification by appropriate regulations, directives, and policies of higher headquarters.

*c.* This chapter deals primarily with procedures used under combat conditions. The discussion of these procedures applies to both the rifle com-

pany, infantry division battle group, and the rifle company, airborne division battle group, unless otherwise stated.

*d.* For duties of personnel having specific administrative and logistical functions, see chapter 1.

*e.* For additional discussion of administration and logistics within the battle group, see FM 7-21 or FM 57-21, as appropriate.

## **209. Personnel Functions**

### *a. Strength Reports.*

- (1) The company commander informally furnishes the battle group personnel officer with necessary information for the company morning report. The company morning report is then prepared by the battle group personnel section and signed by the personnel officer. A file copy of the morning report is furnished to the company.
- (2) The company commander submits a daily strength message to battle group headquarters as prescribed by the battle group SOP.
- (3) The company prepares and forwards casualty or nonbattle loss status reports (DA Forms 1156 and 1157) as prescribed in SR 600-400-5.

*b. Replacements.* Replacements are requisitioned by higher headquarters based on vacancies existing in the company. Upon receipt of replacements, the company commander insures that

they are properly welcomed, oriented, and assigned.

*c. Discipline, Law, and Order.* The company commander is responsible for all matters pertaining to discipline, law, and order within the company. When appropriate, he exercises jurisdiction under Article 15, UCMJ, or prefers charges. Charge sheets and allied papers are normally prepared by battle group headquarters clerks from information furnished by the company commander. See Manual for Courts-Martial, United States, 1951.

*d. Prisoners of War.* The company commander is responsible for the proper handling of prisoners of war in accordance with the Geneva Convention of 1949 and for their evacuation to battle group. See FM 30-15.

*e. Recovery and Disposition.* The company commander is responsible for collecting, identifying, and evacuating the dead, and for safeguarding their personal effects, while in the area of his control. Dead are normally evacuated to the battle group recovery and disposition point on available transportation, such as empty supply vehicles returning to the battle group supply and service area. Personal effects are not removed from the body. When conditions prevent evacuation of the dead, assistance is requested from battle group. The battle group commander may provide personnel and transportation for this evacuation, or he may authorize and furnish instructions on isolated burials.

*f. Morale and Personnel Services.* The com-

pany commander maintains a vital interest in the morale and welfare of members of the company.

- (1) He insures that leave and rest quotas are equitably allocated and that these quotas are filled when conditions permit. Emergency leaves are processed expeditiously in accordance with regulations and policies.
- (2) He insures that all personnel are familiar with decoration policies and that draft recommendations are promptly forwarded to battle group for preparation in final form.
- (3) He insures that mail is promptly delivered and properly handled.
- (4) He insures that services such as legal assistance, welfare, Army exchange, special services, and chaplain's assistance are made available and are properly utilized. He takes appropriate action with higher headquarters on matters over which he has no direct control, such as those concerning pay and allowances.

*g. Civil Affairs/Military Government.* The company commander executes such civil affairs/military government responsibilities (control of civilians) as may be delegated by higher headquarters.

*h. Command Post Operation.* The executive officer normally supervises the operation, dis-

placement, and security of the command post. It must be operational 24 hours a day.

*i. Personnel Procedures.* The company commander takes action as prescribed in Army Regulations on matters pertaining to officer efficiency reports, enlisted conduct and efficiency ratings, appointments, and reductions for inefficiency.

*j. Civilian Personnel.* The company commander insures that the utilization of civilians by his unit conforms to directives of higher headquarters.

## **Section II. COMBAT SUPPLY, RIFLE COMPANY, INFANTRY DIVISION BATTLE GROUP**

### **210. General**

*a.* The company commander has command responsibility and inherent supervisory responsibility for the supply functions of his company and for the proper utilization of all supplies. It is essential for economical as well as tactical reasons that authorized allowances of supplies and equipment are on hand, in serviceable condition, properly cared for, and that no excesses are accumulated. In executing his supply responsibilities, the company commander is assisted by all officers and noncommissioned officers who have supervisory responsibility for supplies and equipment by virtue of their assignment, and by those personnel who have specific supply functions. The executive officer, who normally functions as company supply officer, is the company com-

mander's principal assistant in the supervision of the supply activities of the company.

*b.* The procedures discussed in this section are those which are normally appropriate for most combat situations. Modification of these procedures may be required under special conditions.

*c.* The discussion of accompanying supplies contained in paragraph 217 applies equally to the rifle company, infantry division battle group, in an air-landed operation and to the rifle company, airborne division battle group, in a parachute or air-landed operation.

*d.* For a discussion of aerial resupply, see FM 7-21 and FM 57-21. For definitions and a discussion of the classes of supply, see FM 7-21.

## **211. Company Supply Area**

*a.* The company supply area is the focal point for logistical operations. It is an area selected by the company commander within or immediately in rear of his company area. The company ammunition distributing point (ADP), which is operated by the supply sergeant, is located in this area. Other installations or activities in the supply area may include: kitchen location (when under company control); mess area, or hot food distributing point; distributing point for fuels and lubricants, clothing, and equipment; drop zone or aerial resupply point; and weapons maintenance area.

*b.* In selecting the company supply area, the company commander strives to choose an area which is as near the forward platoons as the

tactical situation will permit, near a good road or trail to the rear, has adequate space, is easily identifiable, provides concealment from ground and aerial observation, and affords cover from flat trajectory fires.

## **212. Food and Water**

a. The company commander submits a daily informal request to the battle group logistical control point for the number and type of rations desired for the next succeeding 24-hour period. At the designated time, company mess personnel draw the rations from the battle group Class I distributing point and take them to the company kitchen, where the meals are prepared.

b. The company kitchen may be under battle group or company control, depending upon the situation. When under battle group control, it operates in the battle group supply and service area under supervision of the battle group supply and maintenance platoon leader. When under company control, it operates in the company supply area or other designated area under the supervision of the company commander.

c. Based on the battle group feeding plan, the company commander prepares a company feeding plan. Included in this plan may be such information as: time of feeding; type of ration to be fed; mess area(s); arrangements for vehicles, guides, and carrying parties; release and return of vehicles; supervision of vehicles while under company control; and arrangements for feeding attached personnel. The company commander



disseminates the feeding plan to the mess steward and to subordinate and attached unit leaders in time to permit necessary planning and implementation.

*d.* Food may be distributed to troops in a number of different ways, depending upon the tactical situation. Hot food is usually brought forward by kitchen truck or smaller vehicle. When the company is in a rear area, it may be appropriate to feed all elements of the company in a company mess area. In many situations, food is taken to platoon areas in order to maintain dispersion of the company and to prevent excessive movement of personnel from their positions. The particular method adopted should result in minimum disruption of activities of the company and minimum reduction in combat effectiveness.

*e.* Water is normally brought forward with food. Some water cans may be left in the company supply area for distribution to platoons.

*f.* Packaged rations are normally brought forward to the company supply area for further distribution to platoons by vehicle or carrying party. Distribution of packaged meals for later use may be made at the serving of a hot meal. When possible, the company commander has mess personnel move necessary equipment to forward areas to heat individual packaged rations and prepare hot drinks.

### **213. Clothing and Equipment**

*a.* While the company normally enters combat with all authorized clothing and equipment (Class II items) in serviceable condition, limited re-

supply is necessary. In addition, the tactical situation may produce requirements for supplies and equipment in addition to those which are normally authorized (Class IV items).

b. Requests for replacement Class II items are informal and are made to the battle group logistical control point by verbal or written message. Requests for major items of equipment, lost or destroyed as a result of enemy action, must be substantiated by a certificate of combat loss or destruction, which is forwarded by the company commander as soon as practicable. Replacement items are normally sent forward to the company with the rations where they are further distributed by the supply sergeant. Procedures for turn-in of unserviceable items are prescribed by battle group.

c. Requests for Class IV items are informal and are made through command channels or to the battle group logistical control point, depending upon the battle group policy. Certain items may be issued automatically, based on operational requirements. Bulky and heavy items, such as fortification materials, may be delivered to points near the using units, while small items are normally sent forward with the rations and are further distributed by the supply sergeant. Class IV items are returned, if appropriate, when the need for them no longer exists.

## **214. Fuel and Lubricants**

Requests for fuel and lubricants are made informally to the battle group logistical control

point based on estimated daily needs. Distribution is normally made from a gasoline tank truck which is sent to the company supply area if conditions permit. It may be necessary, however, to send company vehicles to the battle group supply and service area or other designated point for refueling. The use of 5-gallon cans to resupply fuel is avoided but may be appropriate when a tank truck is unable to move forward to the company area.

### **215. Ammunition**

*a.* The supply sergeant operates the company ADP in the company supply area, assisted by the armorer. The company commander determines which vehicles will be used to establish the ADP. The organic vehicles most readily available for this purpose are the  $\frac{3}{4}$ -ton trucks of the weapons platoon. The three  $\frac{3}{4}$ -ton trucks and trailers of the 81-mm mortar squads are considered to be dual purpose vehicles and are used as logistical transport as well as tactical transport. In determining the number of these trucks to use at the ADP, the company commander must weigh the displacement requirements of the weapons platoon against the anticipated ammunition expenditure of the remaining platoons and the resupply difficulties involved.

*b.* The supply sergeant uses the trucks provided to carry balanced loads of ammunition for the rifle platoons and antitank squads, while the trailers are loaded with 81-mm mortar ammunition. One or more  $\frac{3}{4}$ -ton trailers may be parked

at the mortar position, even though their prime movers are used at the ADP. Ammunition is not normally stacked on the ground.

*c.* As ammunition is expended by the rifle platoons, informal requests for resupply are sent to the supply sergeant. He accomplishes the resupply by sending a vehicle forward to the platoons, if possible. When the terrain or enemy situation will not permit the use of trucks, carrying parties, normally provided by the platoons, are used.

*d.* Ammunition may be resupplied to squads of the weapons platoon by the supply sergeant, or vehicles under weapons platoon control may be sent to the company ADP to procure ammunition. Trailers containing mortar ammunition which are parked at the mortar position are replaced with full trailers when they become empty. When possible, ammunition is delivered to the antitank squads to prevent their moving.

*e.* As ammunition from the company ADP is expended, the supply sergeant redistributes loads on vehicles to free a vehicle for use in obtaining a resupply of ammunition from the battle group ADP. The driver is given an informal request showing the amounts and types of ammunition needed and sent to the battle group ADP, where the request is filled.

*f.* Ammunition may be requested in excess of the authorized basic load in anticipation of expenditures, provided such amounts are for immediate use. For example, additional ammunition to be used in preparatory fires prior to an

attack may be drawn and issued to the firing unit. When ammunition in excess of the basic load is not fired as anticipated, this fact is reported to battle group, and the ammunition is carried on unit transportation or, if directed, turned in to the battle group ADP.

*g.* In defense, the placing of ammunition at weapons positions will be required to permit continuity of fire. The amount to be placed on position is determined by a careful estimate of the ammunition that will be expended before re-supply can be accomplished. Amounts not fired are replaced on unit transportation.

### **Section III. COMBAT SUPPLY, RIFLE COMPANY, AIRBORNE DIVISION BATTLE GROUP**

#### **216. General**

For general supply responsibilities and the execution of company supply functions, see paragraph 210.

#### **217. Accompanying Supplies**

*a.* The quantity and types of supplies and equipment with which the company enters an airborne assault operation are dictated by initial combat requirements. Normally the company enters the operation with only those supplies and equipment that its vehicles and personnel can carry. These items usually consist of organic equipment, the prescribed load of ammunition, enough gasoline per vehicle for 100 miles of

operation, and one combat ration per individual.

b. The composition and distribution of the unit prescribed load depends essentially on the mission, tactical situation, and resupply situation. In general, the following fundamentals apply:

- (1) Accompanying supplies and equipment are combat loaded in aircraft to facilitate rapid recovery by the using unit upon landing. Critical items of equipment and supplies are distributed among aircraft so that loss of a single aircraft will not result in loss of all such equipment.
- (2) Individuals enter the airhead with a minimum of one ration and a prescribed amount of ammunition for their individual weapons.
- (3) Crew-served weapons are dropped or air-landed with a prescribed initial supply of ammunition and with the weapon crew.
- (4) Radios of the company and battle group assault nets (AN/PRC-6 and AN/PRC-10) are carried into the airhead as part of the individual load of the operator.
- (5) Vehicle drivers are dropped near or air-landed with their vehicles.
- (6) Vehicles are dropped or air-landed with their fuel tanks filled to a safe level (generally  $\frac{3}{4}$  full) and with sufficient additional gasoline in 5-gallon cans to provide a total of 100 miles of operation.

- (7) Organic vehicles normally used as ammunition carriers are loaded with appropriate ammunition.

c. The company and each of its subordinate elements are responsible for the recovery of their own unit prescribed loads.

### **218. Company Supply Control Point**

a. The company supply control point is the focal point for the supply functions. Its location is selected by the company commander. The initial location is normally selected during the planning phase of the operation. The supply control point is operated by the unit supply specialist, normally under the supervision of the executive officer.

b. In selecting the location of the supply control point, the company commander strives to choose an area which is accessible to  $\frac{3}{4}$ -ton utility trucks, provides concealment from ground and air observation, affords cover from flat trajectory fires and is near the company command post.

### **219. Resupply**

a. Requests for resupply of the company are made informally, by verbal or written message, to the battle group supply control point. The procedures used to resupply the elements of the company depend upon several factors, including the tactical situation, terrain, urgency, availability of vehicles, and distances involved. Any one or a combination of the following methods may be used:

- (1) Delivery of supplies by trucks of the

battle group supply and transportation platoon direct to the using element of the company.

- (2) Delivery of supplies by trucks of the battle group supply and transportation platoon to the company supply control point, where the supplies are off-loaded and further distributed.
- (3) Pickup of supplies from the battle group distributing point using company vehicles. When this method is used, coordination is effected by the executive officer or the administrative specialist. Certain company vehicles may be pooled under company control for procuring and distributing supplies.
- (4) Aerial resupply directly to the company or its elements for further distribution or use.

b. The method of resupply used in any operation is determined by the battle group S4. When trucks of the battle group supply and transportation platoon are used, the following considerations apply:

- (1) Whenever possible, these trucks deliver supplies directly to the using element within the company.
- (2) Supplies off-loaded at the company supply control point are distributed as soon as possible to using elements. Normally supplies are not stockpiled at the company supply control point.



(3) Transfer of supplies from one vehicle to another is held to a minimum.

*c.* Gasoline is resupplied to the company in 5-gallon cans, with an empty can being exchanged for a full one.

*d.* Packaged rations are normally used during the assault phase of the operation. Rations are usually issued once daily and distributed during the night preceding the day of use. When the company mess is operating in the airhead, its control and operation are as described in paragraph 212.

*e.* For additional discussion of resupply within the battle group, see FM 57-21.

#### **Section IV. MISCELLANEOUS LOGISTICAL ACTIVITIES**

##### **220. Medical Service**

*a.* Within the infantry division battle group, 5 company aidmen from the battle group medical platoon are normally attached to the company to provide emergency medical treatment. The company commander directs the disposition of attached aidmen. Normally 1 aidman accompanies each rifle platoon, and 1 accompanies the weapons platoon or remains under company control, as appropriate. Walking wounded are directed to the battle group aid station by the aidmen, while the evacuation of other casualties to the aid station is accomplished by litter bearers or frontline ambulances of the medical platoon.

*b.* Within the airborne division battle group,

four company aidmen from the battle group medical platoon are normally attached to the company to provide emergency medical treatment. Normally the company commander directs one of the attached aidmen to accompany each rifle platoon. Evacuation is the responsibility of the battle group medical platoon and is accomplished as described in *a* above.

## **221. Maintenance and Repair**

*a.* Proper maintenance of all equipment and supplies is essential to the combat efficiency of the company. Command supervision of maintenance is mandatory. Before entry into combat, the company commander assures that all equipment is in the best possible condition.

*b.* Within the rifle company, the maintenance capability is generally limited to that which can be accomplished by the individual soldier. Additional maintenance assistance is furnished by higher headquarters. Small items requiring repair beyond the capability of the company are normally evacuated to the battle group supply and service area on available transportation. Maintenance personnel at higher headquarters may be sent forward to the company area to repair large items, such as vehicles.

*c.* Within the rifle company, infantry division battle group, the armorer makes minor repairs within his capability on the organic weapons. Second echelon maintenance on company vehicles is performed by the battle group supply and maintenance platoon.

d. Second and third echelon maintenance for the rifle company, airborne division battle group, is accomplished by a support platoon of the emergency repair company, division maintenance battalion, which supports the battle group. Within the airhead, only limited second echelon maintenance is normally available. Initially, repairs are limited to critical items damaged during the parachute landing.

e. For additional discussion of maintenance and repair, see FM 7-21 or FM 57-21, as appropriate.

## **222. Miscellaneous Services**

a. *Exchange of Clothing.* Except for exchange of socks and underwear, it is usually impracticable to issue clean clothing to the company when in contact with the enemy. Exchange of clothing is normally accomplished while the company is in reserve or a rest area. Clean clothing may be issued in bulk to the company for further distribution, or clean clothing may be issued to individuals at a bath unit. Troops wash their own clothing when other facilities are not available.

b. *Bathing of Troops.* A bath unit may be available for use by the company on a schedule prescribed by higher headquarters.

c. *Bedrolls.* Bedrolls contain articles needed by the troops for their personal comfort, such as shelter halves, blankets, or sleeping bags. Rolls are usually carried on the trailer of the kitchen truck and are delivered to the company whenever the situation permits and warrants their use.

## APPENDIX I

### REFERENCES

---

- |           |   |
|-----------|---|
| AR 59-106 | Operation of Air Force Terminals  |
| AR 220-70 | Companies—General Provisions  |
| AR 320-50 | Authorized Abbreviations and Brevity Code                                   |
| AR 385-63 | Regulations for Firing Ammunition for Training, Target Practice, and Combat |
| AR 735-35 | Supply Procedures for TOE Units, Organizations, and Non - TOE Activities    |
| AR 320-5  | Dictionary of United States Army Terms                                      |
| AR 600-66 | Report of Casualties Originating in Combat Areas                            |
| FM 3-5    | Tactics and Techniques of CBR Warfare                                       |
| FM 5-10   | Routes of Communications  |
| FM 5-15   | Field Fortifications  |
| FM 5-20   | Camouflage, Basic Principles and Field Camouflage                           |

FM 5-25	Explosives and Demolitions
FM 5-31	Use and Installation of Booby Traps
FM 6-135	Adjustment of Artillery Fire by the Combat Soldier
FM 7-21	Headquarters and Headquarters Company, Infantry Division Battle Group
FM 7-24	Communication in Infantry and Airborne Divisions
FM 7-40	Infantry Division Battle Group
FM 17-1	Armor Operations, Small Units
FM 17-20	Armored Infantry Units; Platoon, Company, and Battalion
FM 20-32	Employment of Land Mines
FM 20-60	Battlefield Illumination
FM 21-5	Military Training
FM 21-6	Techniques of Military Instruction
FM 21-10	Military Sanitation
FM 21-11	First Aid for Soldiers
FM 21-15	Care and Use of Individual Clothing and Equipment
FM 21-18	Foot Marches
FM 21-26	Map Reading

FM 21-30	Military Symbols
FM 21-40	Small Unit Procedures in Atomic, Biological, and Chemical Warfare
FM 21-41	Soldiers Handbook for Nuclear, Biological, and Chemical Warfare
FM 21-48	CBR Training Exercises
FM 21-60	Visual Signals
FM 21-75	Combat Training of the Individual Soldier and Patrolling
FM 21-76	Survival
FM 21-77	Evasion and Escape
FM 21-150	Hand-to-Hand Combat
FM 22-5	Drill and Ceremonies
FM 22-100	Military Leadership
FM 23-5	U.S. Rifle, Caliber .30, M1
FM 23-7	Carbine, Caliber .30 M1, M1A1, M2, and M3
FM 23-15	Browning Automatic Rifle, Caliber .30 M1918A2
FM 23-25	Bayonet
FM 23-30	Hand and Rifle Grenades
FM 23-32	3.5-inch Rocket Launcher
FM 23-55	Browning Machineguns, Caliber .30 M1917A1, M1919A4, M1919A4E1, M1919A6, and M37
FM 23-65	Browning Machinegun, Caliber .50 HB M2
FM 23-71	Rifle Marksmanship Course; Trainfire I

FM 23-82	106-mm Rifle, M40A1
FM 23-90	81-mm Mortar, M29
FM 24-18	Field Radio Techniques
FM 24-20	Field Wire Techniques
FM 25-10	Motor Transportation, Operations
FM 27-10	The Law of Land Warfare
FM 30-5	Combat Intelligence
FM 30-7	Combat Intelligence, Bat- tle Group, Combat Com- mand, and Smaller Units
FM 30-15	Examination of Personnel and Documents
FM 31-10	Barriers and Denial Oper- ations
FM 31-15	Operations Against Air- borne Attack, Guerilla Action, and Infiltration
FM 31-25	Desert Operations
FM 31-50	Combat in Fortified Areas and Towns
FM 31-60	River-Crossing Operations
FM 31-70	Basic Arctic Manual
FM 31-71	Northern Operations
FM 31-72	Mountain Operations
FM 55-37	Transportation Battalion, Infantry Division
FM 57-21	Headquarters and Head- quarters, Airborne Divi- sion Battle Group (when published)
FM 57-30	Airborne Operations

FM 57-35	Army Transport Aviation —Combat Operations
FM 57-100	The Airborne Division (when published)
FM 70-10	Mountain Operations
FM 72-20	Jungle Operations
FM 100-5	Field Service Regulations; Operations
(C) FM 100-31	Tactical Use of Atomic Weapons (U)
FM 101-10	Staff Officers' Field Man- ual; Organization, Tech- nical, and Logistical Data
TM 10-405	Army Mess Operation
TM 57-210	Air Movement of Troops and Equipment
TM 57-220	Technical Training of Parachutists
DA Pam 108-1	Index of Army Motion Pic- tures, Film Strips, Slides, and Phonorecord- ings
DA Pam 310-Series	Military Publications In- dexes (as applicable)



## APPENDIX II

### ESTIMATE OF THE SITUATION

---

#### 1. General

*a.* When a unit is assigned a mission, the commander or leader must determine the best way to accomplish it. Since there is always more than one way to accomplish any mission, there must be a systematic method of selecting the course of action which offers the greatest possibility of success. The problem solving process used to arrive at this decision is called the estimate of the situation.

*b.* An estimate is a continuing process. After making his initial estimate, the commander reviews it with each change in the situation to determine if the current course of action should be continued or if a new course should be adopted. The estimate may be made quickly or deliberately, depending primarily on the time available. In either event, a sound decision can be reached only if all the facts bearing on the accomplishment of the mission are considered.

*c.* The sequence of the elements of the estimate presented here provides for the logical and orderly examination of all the facts, and it serves as a mental checklist to insure that nothing is

overlooked. Regardless of the rapidity with which the estimate is made, this sequence should be followed.

## **2. Steps in the Estimate of the Situation**

*a. Mission.*

*b. The Situation and Courses of Action.*

(1) Weather; terrain; enemy situation, friendly situation.

(2) Enemy capabilities.

(3) Own courses of action.

*c. Analysis of Opposing Courses of Action.*

*d. Comparison of Own Courses of Action.*

*e. Decision.*

## **3. Discussion**

*a. Mission.* A thorough understanding of the task to be performed is essential. If there is any question about the assigned mission, additional information must be obtained from the commander who assigned the mission. Throughout the conduct of the operation, the mission must be kept foremost in mind. Situations arise which might divert the commander unless he continually reviews in his mind the task which was assigned to him.

*b. The Situation and Courses of Action.* The purpose of this step is to consider all the factors which affect the employment of the unit, the capabilities of the enemy that could threaten the accomplishment of the mission, and the reasonable courses of action which will, if successful, accomplish the mission.

- (1) The weather is considered as it will affect personnel, equipment, and the area of operations.
- (2) A thorough terrain analysis is made of the area of operations. The terrain is studied both from the friendly and enemy viewpoint to evaluate observation and fields of fire, concealment and cover, obstacles, critical terrain features, and avenues of approach. The commander considers how these aspects of the terrain will affect the mission.
- (3) The enemy and friendly situation are studied to determine the relative strengths and weaknesses of each. Such factors as the strength, dispositions, reinforcements available, weapons, fire support available, morale, status of supply, and recent significant activities are considered.
- (4) Enemy capabilities are all courses of action of which the enemy is physically capable and which, if adopted, will affect accomplishment of the mission.
- (5) The commander lists in his mind the practicable ways which are open to him to perform the assigned task. All feasible courses of action which will accomplish the mission are considered. No decision is reached at this point; rather, all the possibilities are mentally listed so that none is overlooked.

*c. Analysis of Opposing Courses of Action.*

Having determined the possible courses of action, the commander considers how each of these would be affected by each of the enemy's capabilities. In this analysis, the commander visualizes the probable outcome of each course of action when opposed by each enemy capability. During this analysis, the other factors such as weather, terrain, enemy situation, and friendly situation, are also considered as they affect the courses of action. Certain of these factors may have the same effect on each course of action. Other factors, called the *governing factors*, have a different influence on the various courses, and it is these governing factors which are the basis for the comparison in the next step.

*d. Comparison of Own Courses of Action.* The governing factors will usually be the *terrain, enemy dispositions, friendly dispositions, and enemy capabilities*. Using the selected governing factors as a basis, the commander compares the various courses of action in light of the governing factors and weighs the advantages and disadvantages of each. Based on his military knowledge, experience, and his sound judgment, he selects the course of action which offers the best chance of success. If two or more courses of action offer equal promise, he selects the one which most favors future action.

*e. Decision.* The course of action selected is translated into a concise statement of what the unit will do. It includes answers to the questions **WHO, WHAT, WHEN, WHERE, HOW, and WHY.**

## APPENDIX III

---

### TROOP LEADING PROCEDURE

#### 1. General

a. Troop leading procedure is the logical sequence of action which a leader follows while preparing and executing an assigned mission, making best use of his time, facilities, and personnel.

b. Troop leading procedure as discussed in this appendix is appropriate for all leaders within the company in all types of operations. The sequence of the steps is not rigid. Depending on the existing circumstances, the level of command, and the type of operation, some steps or elements may be accomplished before others. In some situations, all steps may not be required or may not be possible because of time limitations. Time is the governing factor in the application of the steps of troop leading procedure, and though all steps should be considered, the degree of consideration of each may vary. The sequence as outlined is suitable for many situations; it is presented as a guide, to be modified as necessary, to assist the leader in making maximum use of available time and means to prepare for and execute his mission.

## 2. Steps of Troop Leading Procedure

### a. *Begin Planning.*

- (1) Upon receipt of the order from his next higher commander, the leader begins by planning the use of the time available. Based upon his experience, he allots a portion of the time for his own reconnaissance and planning and a portion for the reconnaissance and planning of his subordinates.
- (2) He next begins his estimate of the situation (app. I).
  - (a) Utilizing a map, sketch, or aerial photograph, he makes a terrain analysis to determine observation and fields of fire, concealment and cover, obstacles, critical terrain features, and avenues of approach in his area of operation and in adjacent areas.
  - (b) He studies the enemy situation, analyzing the enemy strength, locations, dispositions, and capabilities.
- (3) Based on this initial estimate, he formulates a preliminary plan of action. This is tentative and serves as a basis for future planning. It is announced as guidance to individuals who will make recommendations on the employment of their units. For example, in the attack, the company commander tells the weapons platoon leader, the artillery FO, and an attached tank pla-

toon leader his preliminary plan of attack; in the defense, the rifle platoon leader tells his weapons squad leader his preliminary plan of defense.

*b. Arrange For—*

- (1) *Movement of the unit.* The leader must plan early for the movement of his unit, if appropriate, to include where, when, and how. Often the company commander will arrange for the movement of the entire company from an assembly area under control of the executive officer. At other times subordinate leaders must arrange for the movement of their own units. Sometimes the leader can return and bring his unit forward, while at other times he may send a messenger back with instructions for the second-in-command to accomplish this. Instructions should be explicit and should include the route to be used, order of march; and location, time of arrival, and dispositions in the new location.
- (2) *Reconnaissance.* The leader plans his reconnaissance so as to cover the desired area as completely as time permits. He may plan to coordinate with certain individuals at specified points and times. He plans which persons will accompany him. When time is limited, the company commander may assign specific reconnaissance responsibilities

to his subordinates (such as the weapons platoon leader), directing them to make recommendations based on their reconnaissance. The rifle platoon leader may assign similar responsibilities to his platoon sergeant or weapons squad leader, as appropriate.

- (3) *Issuance of order.* The leader informs his subordinates as early as possible, when, where, and to whom he will issue his order. When the terrain and enemy situation permit, he plans to orient his leaders from a vantage point overlooking the area of operations. He may use a messenger to guide the subordinate leaders forward.
- (4) *Coordination.* The leader plans to coordinate with adjacent unit leaders and with leaders or representatives of supporting units, units in contact, or other units with which he will come in contact during the operation. Many of these leaders will be present for the issuance of the higher commander's order, and certain coordination can be accomplished at this time. The leader makes plans to meet these and other leaders at a later time. The purpose of the coordination is to exchange information on plans of operation to insure that there is no conflict between units.

*c. Make Reconnaissance.* On his ground reconnaissance, the leader makes a continuing estimate



of the situation. He completes his terrain analysis and selects, as appropriate, such items as routes, weapons position areas, sectors of fire, targets, etc. He notes the effects of the terrain on his preliminary plan, and he rejects, alters, or adopts appropriate portions of this plan accordingly. During his reconnaissance, he coordinates with adjacent and supporting unit leaders as planned.

*d. Complete Plan.* After completing his reconnaissance, the leader receives recommendations from selected subordinates, if appropriate. Based on their recommendations and upon his personal reconnaissance, he revises as necessary his initial estimate and his preliminary plan, and he completes his plan of action. He then prepares notes to be used in issuing his order.

*e. Issue Order.* At the time and place previously designated, he meets his subordinates. He orients them on the terrain from a vantage point, or, if this is not possible, uses maps, sketches, aerial photographs, or an improvised sandtable. He then issues his order, using the standard operation order sequence, and includes everything his subordinates need to know. He allows his subordinates to ask questions. He, in turn, determines if the order is understood by asking them questions.

*f. Supervise.* The leader, with the assistance of his subordinates, actively supervises his unit to insure that the order is carried out as intended. If he notes a deficiency or a misunder-

standing, he takes immediate corrective action. His supervision is vigorous and continuous throughout the conduct of the operation. The need for supervision cannot be overemphasized.

## APPENDIX IV

# OPERATION ORDERS

---

An operation order is an order which sets forth the situation, the mission, the commander's decision and plan of action, and details of execution necessary to insure coordinated action by the unit. Warning orders, which contain advance information and instructions pertaining to future operations, are used to permit timely preparation and concurrent planning for action. When sufficient time is available, complete operation orders are issued; however, when time is lacking, the commander may issue fragmentary orders, which contain only the necessary information and instructions required for one or more units to accomplish a mission. At company level and below, operation orders are habitually issued orally. A map overlay or a sketch is frequently used in connection with an oral order. To insure that operation orders are complete and uniformly issued, the following prescribed sequence is used by commanders and leaders at all echelons. Paragraph numbers and paragraph titles shown here, are not normally stated in *oral* orders.

### 1. Situation

This paragraph contains information of the enemy and friendly forces that subordinates

should know in order to accomplish their missions. Only pertinent information is included, as follows:

*a. Enemy Forces.* Information of the enemy pertaining to the operation, such as locations, dispositions, strength, activities, and capabilities.

*b. Friendly Forces.* Mission of next higher unit, location and missions of adjacent units, and missions of nonorganic supporting elements which may affect the actions of the unit.

*c. Attachments and Detachments.* Elements attached to or detached from the unit for the operation, including the effective time of attachment or detachment.

## **2. Mission**

A clear, concise statement of the task to be accomplished by the unit.

## **3. Execution**

This paragraph states the general plan for the conduct of the operation and assigns specific missions to each subordinate tactical element, including attachments.

*a.* The *concept of operation* is the commander's overall plan for the operation. It includes the scheme of maneuver and the use of fire support.

*b.* Specific tasks are assigned to each subordinate element, to include committed maneuver elements, organic supporting elements, attachments, and the reserve, in that order. In assigning an element its mission, attachments or detachments are indicated.

*c.* Coordinating instructions, which are included at the end of the paragraph, contain those tactical instructions which apply to two or more of the subordinate elements. (Example: line of departure, time of attack, control measures, restrictions, etc.)

#### **4. Administration and Logistics**

This paragraph contains information or instructions pertaining to rations, ammunition, locations of distributing points and aid station, transportation, and other administrative and supply matters. Only necessary information is included.

#### **5. Command and Signal**

*a.* Special signal instructions, which include such items as prearranged signals and restrictions on the use of radio or other means of communication.

*b.* Location of the commander and command post during the operation.

# APPENDIX V

## COMBAT FORMATIONS

---

### Section I. DISMOUNTED FORMATIONS

#### 1. General

a. Squad and platoon combat formations are groupings of individuals and units for efficient tactical employment. The factors influencing the leader's decision as to the selection of any particular formation are the mission, terrain and weather, situation, speed, and degree of flexibility.

b. The combat formations depicted in this appendix are appropriate for most combat situations. However, they should not be thought of as the *only* formations which may be used. Some variations of these formations may be necessary or desirable in certain situations.

c. All formations are shown with full-strength units, a condition which may not exist either in training or in combat. Squad formations, in particular, will frequently have to be modified to conform to the number of men in the squad. When the squad is less than full strength, the positions which are normally eliminated first are the numbers 6 and 11 men, and then the

numbers 5 and 10 men. In modifying squad formations to conform to a particular situation, or because of the reduced strength of the squad, the following fundamentals generally apply:

- (1) Intermingling of fire teams is avoided.
- (2) The fire team leader is located so as to facilitate control of the fire team, especially in its deployment.
- (3) When deployed in the as skirmishers formation, the fire team leader is generally in the center of his fire team to facilitate control. The automatic riflemen are located within the fire team where they can most effectively apply and distribute their fire.
- (4) When in column formation, one automatic rifleman is located on each side of the column.

*d.* In combat, formations may be modified so that a few individuals are not habitually in the most exposed positions. For example, the squad leader may use his ALFA team as the leading team at times, and at other times he may lead with the BRAVO team. Within the fire teams, riflemen may be rotated to different positions.

## **2. Squad Formations**

### *a. General.*

- (1) The rifle squad is organized for combat into two fire teams, ALFA and BRAVO (fig. 39).
- (2) The rifle squad combat formations are the squad column, squad file, and as

skirmishers. When the weapons squad moves as part of the platoon, it usually moves in column formation.

- (3) The initial squad combat formation is normally prescribed by the platoon leader. Thereafter, the squad leader may alter his formation to meet changes in the situation and terrain. The squad leader places himself within the formation where he can best exercise control. The squad observes at all times to the front, flanks, and rear. When moving or at a halt, members of the squad are responsible for observing in definite directions.
- (4) The squad leader controls the squad by oral commands and arm and hand signals. Based on the squad leader's order, fire team leaders position themselves in the designated formation and other members of the squad take their appropriate positions based on the location of their fire team leader.
- (5) The distances between individuals within a formation will vary, depending primarily on the visibility and the terrain over which the squad is moving. While maximum dispersion is desirable to reduce vulnerability to direct and indirect fires, effective control must be maintained. In open terrain, the squad formation will be relatively open. In close terrain (such as woods, heavy



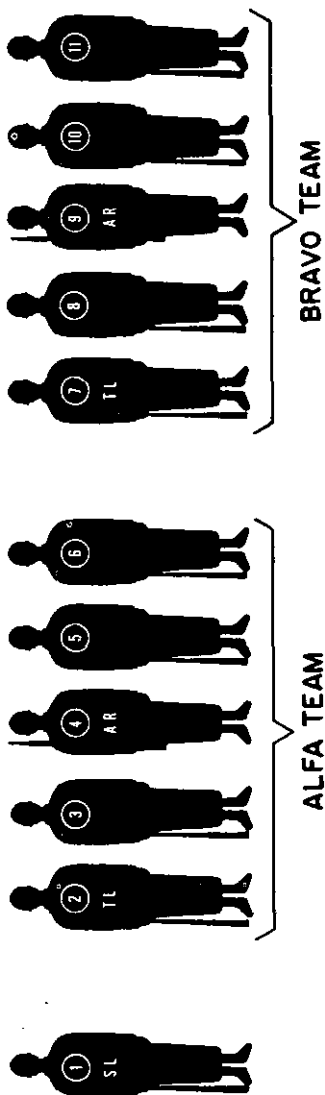

Figure 39. Organization of the rifle squad for combat.

underbrush, etc.) or under conditions of low visibility (such as at night, in smoke, fog, etc.), distances between individuals must normally be reduced considerably to permit control.

b. *Squad Column*. This is the basic formation for movement. It is normally used when the squad is moving as part of the platoon, under conditions when a degree of lateral dispersion within the squad is possible without sacrificing control. While in this formaton, the squad is able to deliver a large volume of fire to the flanks but only a limited amount to the front. The squad column is a flexible formation which facilitates the use of battle drill (app. VI). Two basic variations of the squad column are shown, one with fire teams one behind the other, and the second showing the fire teams abreast. Either of these may be modified by the squad leader to provide greater dispersion laterally and permit a greater volume of fire to be delivered forward initially.

- (1) *Squad column with fire teams in column*. This variation is used most frequently in areas where maneuver of the rear (trailing) fire team is unrestricted. This formation facilitates the use of battle drill because the leading fire team can immediately engage the enemy while the trailing team is used to maneuver. The ALFA team leads in the formation unless otherwise directed by the squad leader. To facilitate control,

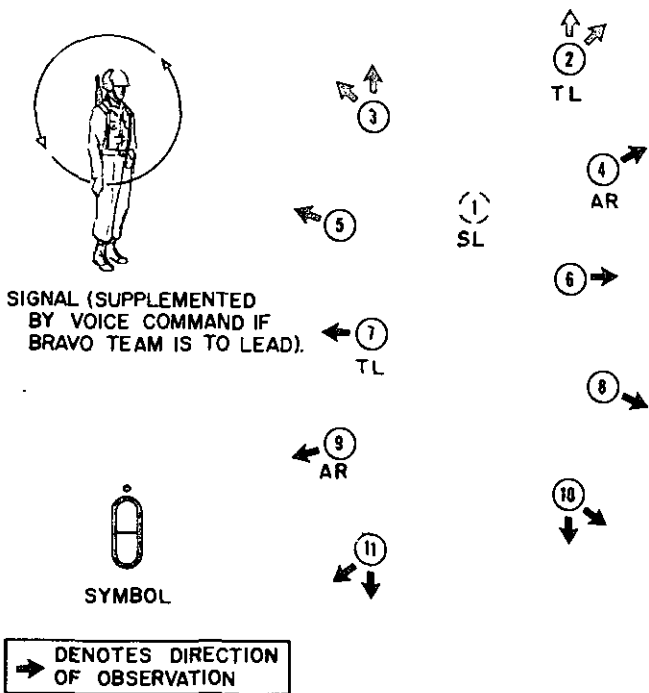

Figure 40. Squad column with fire team\* in column showing ALFA team leading and BRAVO team close behind.

the teams may be kept close to one another as shown in figure 40. When terrain and visibility permit, the squad leader may separate his fire teams, having the rear team follow at a specified distance, as shown in figure 41. The distance between fire teams in this formation is not so great that the squad

leader cannot have direct, immediate control over the rear team.

- (2) *Squad column with fire teams abreast* (fig. 42). This variation of the squad column is used for movement in areas where maneuver of the fire teams is restricted. It is used most frequently in the approach march when the squad is moving along a road. Under such conditions, the fact that the enemy may have the road covered by fire will frequently prevent moving personnel across the road once the squad is brought under fire, even if the fire teams are separated as shown in figure 41. Consequently, fire teams are placed abreast to facilitate their deployment on each side of the road without having any personnel cross it. The ALFA team is on the right unless otherwise directed by the squad leader.
- (3) *Modification of the squad column.* The squad column may be modified by the squad leader as necessary to conform to the terrain and to provide a greater capability to deliver fire immediately to either the front or rear. Such modification may consist merely of the squad leader instructing those individuals in the center of the formation to move farther to the flanks (fig. 43). This variation is used most frequently when the squad is operating away from

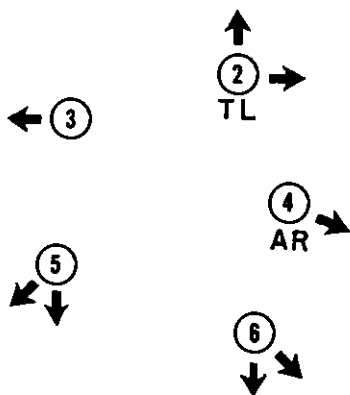
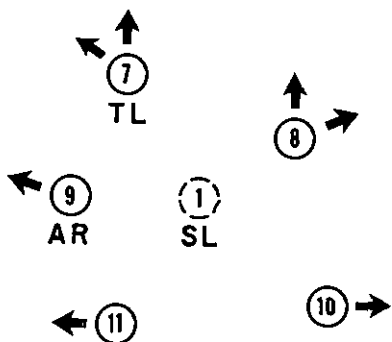

Figure 41. Variation of squad column with fire teams in column, showing BRAVO team leading and ALFA team trailing at a distance.

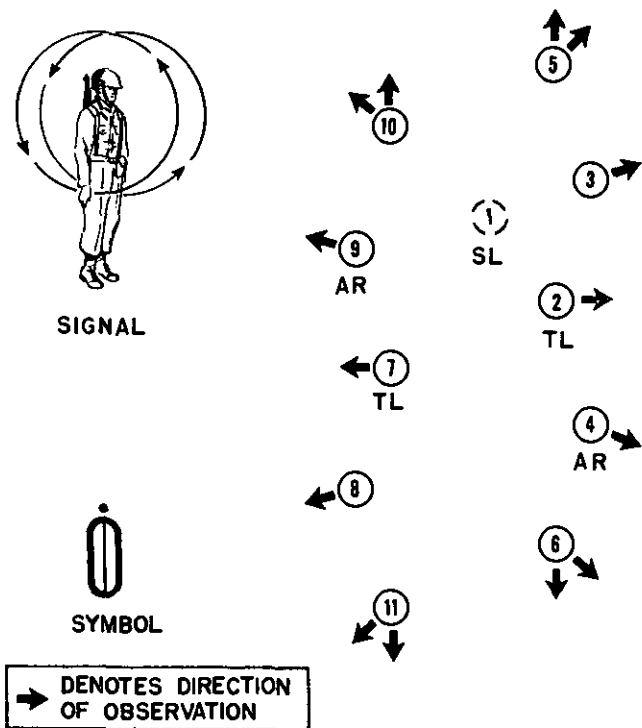
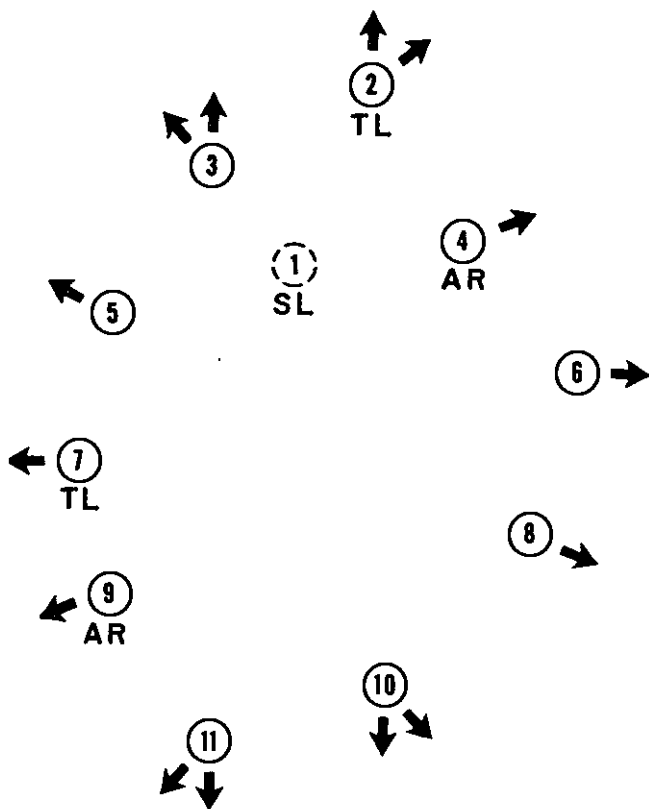

Figure 42. Squad column with fire teams abreast.

other elements of the platoon, such as when on patrol or on a semi-independent mission.

c. *Squad File* (fig. 44). This is used for moving over terrain which is so restrictive that the squad cannot adopt a column formation, or when visibility is so reduced that control becomes extremely difficult. This formation facilitates con-



*Figure 43. Example of modification of squad column (fire teams in column).*

trol of movement and delivery of fire to the flanks, but restricts firepower forward. Deployment of the squad from this formation is not as easy as from the squad column. Positions of individuals as shown in figure 44 are not fixed

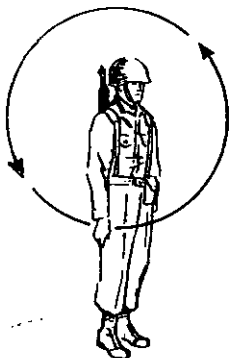

**SIGNAL  
(SUPPLEMENTED BY  
VOICE COMMAND)**



3

1  
SL

2  
TL

4  
AR

5

6

8

7  
TL

9  
AR

10

11

*Figure 44. Squad file showing ALFA team leading.*



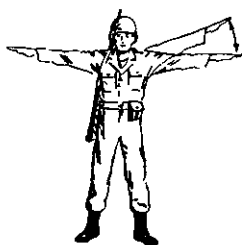

TO SIGNAL AS SKIRMISHERS  
WHEN FIRE TEAMS ARE IN  
COLUMN, WAVE ARM AS  
INDICATED IN DIRECTION REAR  
TEAM IS TO MOVE.

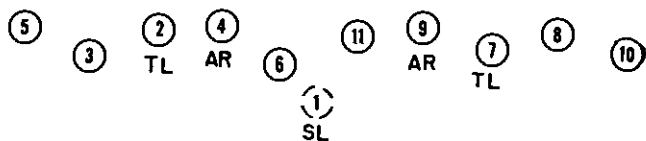

Figure 45. As skirmishers, ALFA team on left.

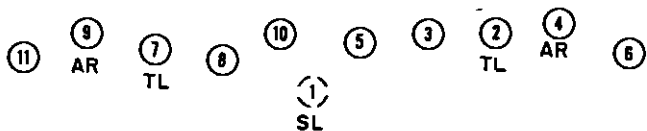

Figure 46. As skirmishers, ALFA team on right.

but may be altered as desired to conform to the existing situation. The ALFA team leads unless otherwise directed by the squad leader.

*d. As Skirmishers* (figs. 45 and 46). This is the basic assault formation of the squad. It is also suitable for mopping up enemy resistance and for crossing short, open areas. It provides maximum firepower to the front, but it is relatively difficult to control. Specific locations of individuals within the formation, especially automatic riflemen, may be changed by the squad leader in a particular situation to provide greater concentration of fire in a certain area.

*e. Formation Changes.* These changes are made without halting the squad. For specific movements of individuals, see appendix VI.

### **3. Platoon Formations**

When three squads are abreast, the center rifle squad is the base squad unless otherwise designated by the platoon leader. In all other formations, the leading or right leading rifle squad is the base squad. The distances between men and squads may be increased or decreased, and the men may be staggered to the left and right, according to the orders of the platoon leader. The combat formations for the platoon are the platoon column, wedge, vee, echelon, and line. The symbols used in figures 48 to 52 are shown in figure 47.

*a. The platoon column* (fig. 48) is used when speed and control are the governing factors, such as when moving through woods, fog, smoke,

## PLATOON COMMAND SYMBOLS

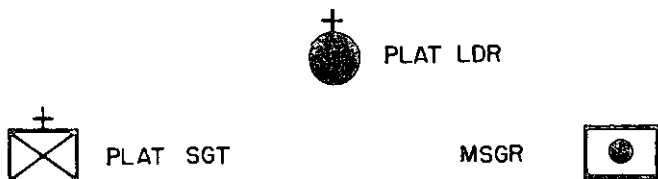

Figure 47. Symbols used in figures 48 to 52.

darkness, defiles, or along roads and trails. This formation is flexible, affords excellent control, and favors action to the flanks. It does not provide as much all-round security as other formations.

b. The *platoon wedge* (fig. 49) is used when the enemy situation is obscure and when the terrain and visibility demand dispersion. It affords good control, flexibility, and all-round security.

c. The *platoon vee* (fig. 50) is used when the enemy is believed to be directly to the front and his approximate strength and location are known. It provides excellent firepower to the front, facilitates movement into the platoon assault formation, and may be used for crossing small open areas.

d. *Platoon Echelon* (fig. 51). This is used to protect an open or exposed flank. It permits heavy fire to the front and in the direction of the echelon. It is difficult to control and is slow, especially under conditions of poor visibility.

e. *Platoon Line* (fig. 52). This may be used

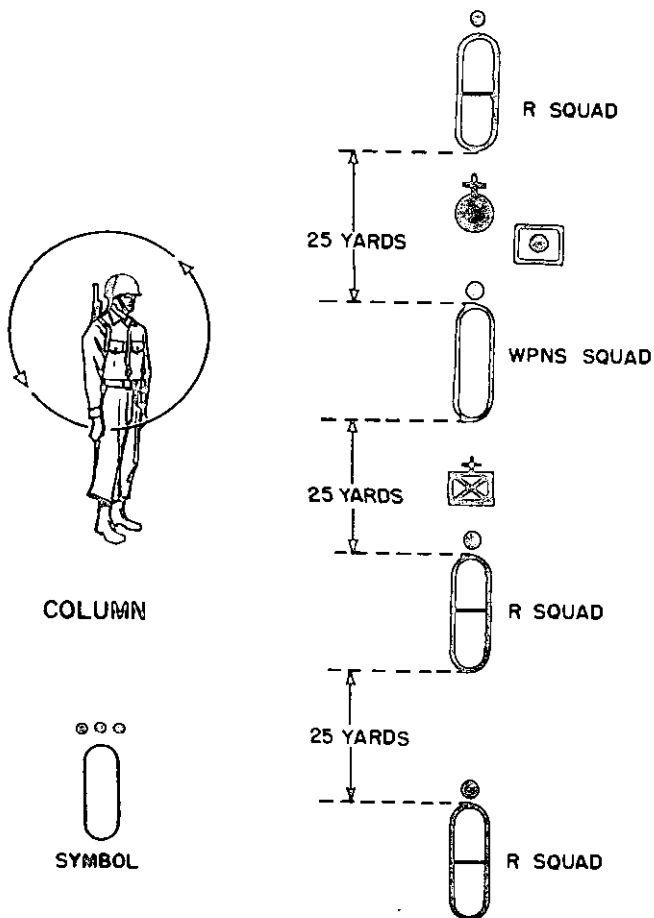

Figure 48. Platoon column.



WEDGE

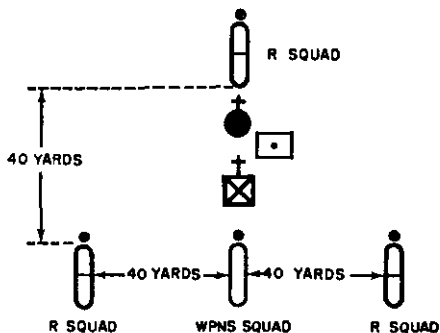

Figure 49. Platoon wedge.



VEE

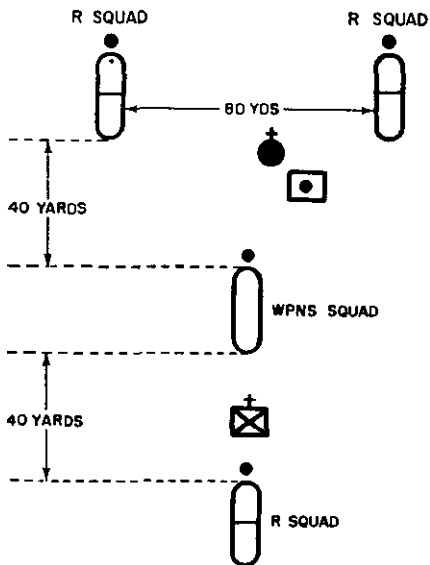

Figure 50. Platoon vee.

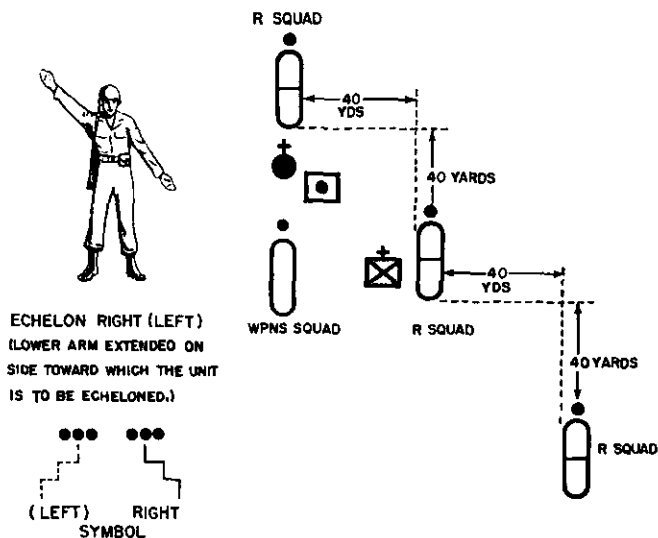

Figure 51. Platoon echelon.

during the assault phase when battle drill is not used or for crossing short exposed areas. It provides maximum concentration of fire to the front, but is difficult to control.

#### 4. Formation Changes

After the platoon learns to move into each of the basic formations, it then practices moving and changing from one to another while advancing. The methods for moving and halting are similar to those for the squad. In changing from one formation to another, the designation of the base squad sometimes changes, as explained in paragraph 3. For example, in chang-

ing from platoon line to platoon vee, the center rifle squad remains the base squad until the vee formation is completed, then the right leading rifle squad becomes the base squad. The redesignation of the base squad takes place upon completion of the movement. Some suggested methods for changing platoon formations are shown in figure 53. All changes in combat formations are made without halting the unit.

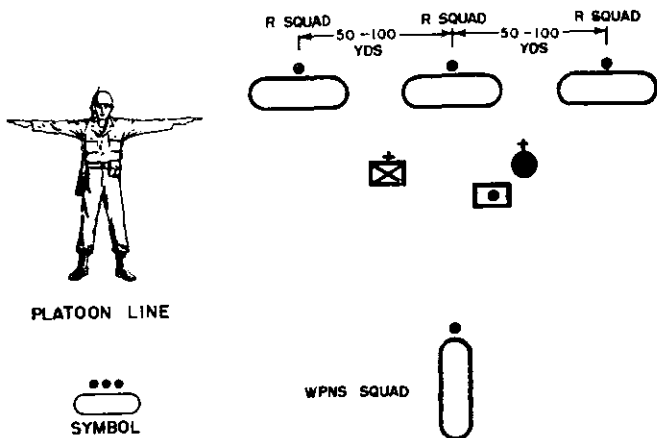
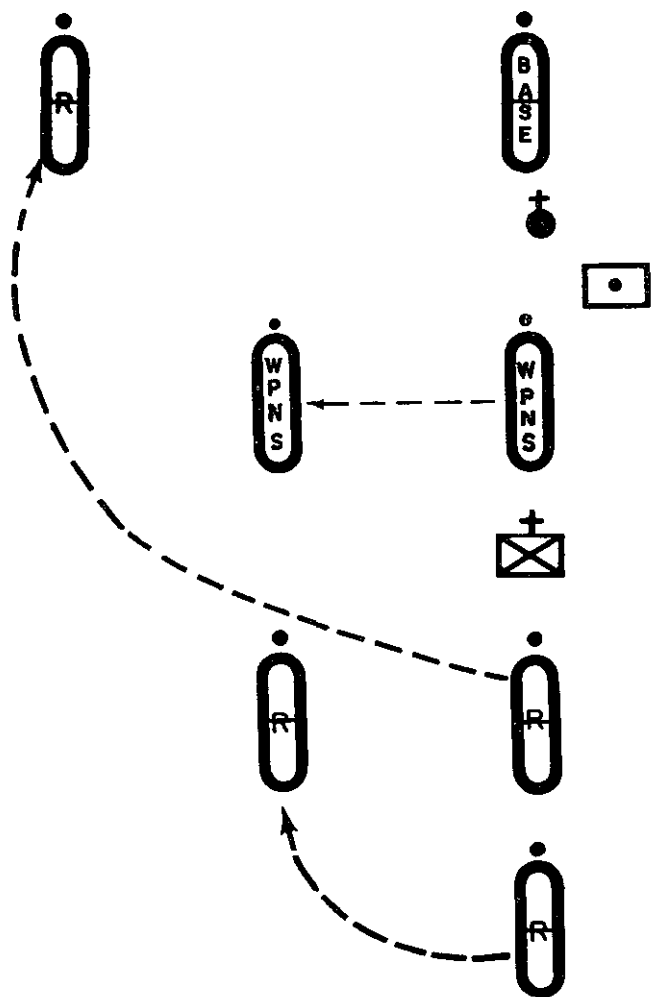

Figure 52. Platoon line.



1 Column to vee.

*Figure 53. Changing platoon formations.*



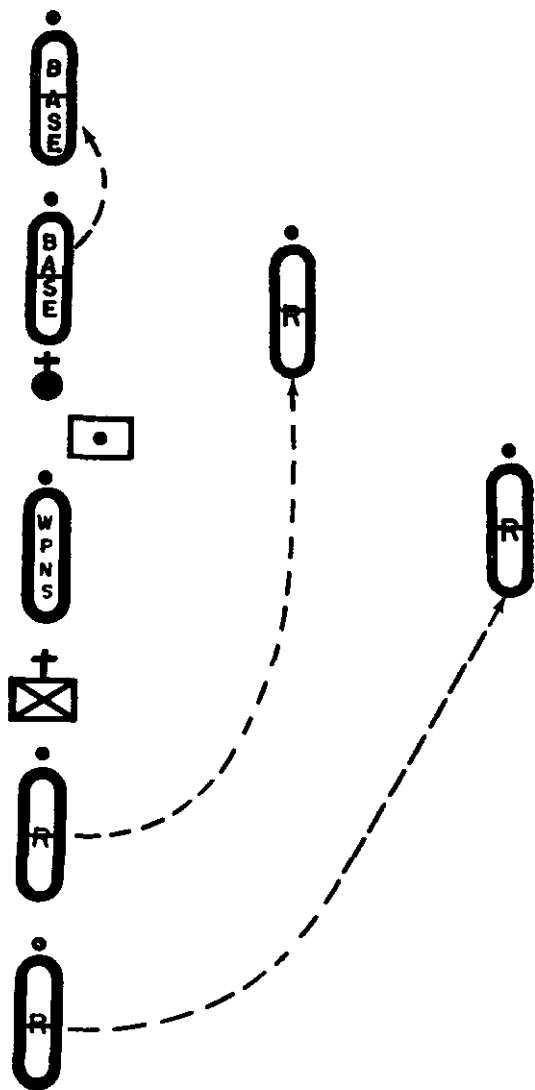

2 Column to echelon right.  
*Figure 53—Continued.*

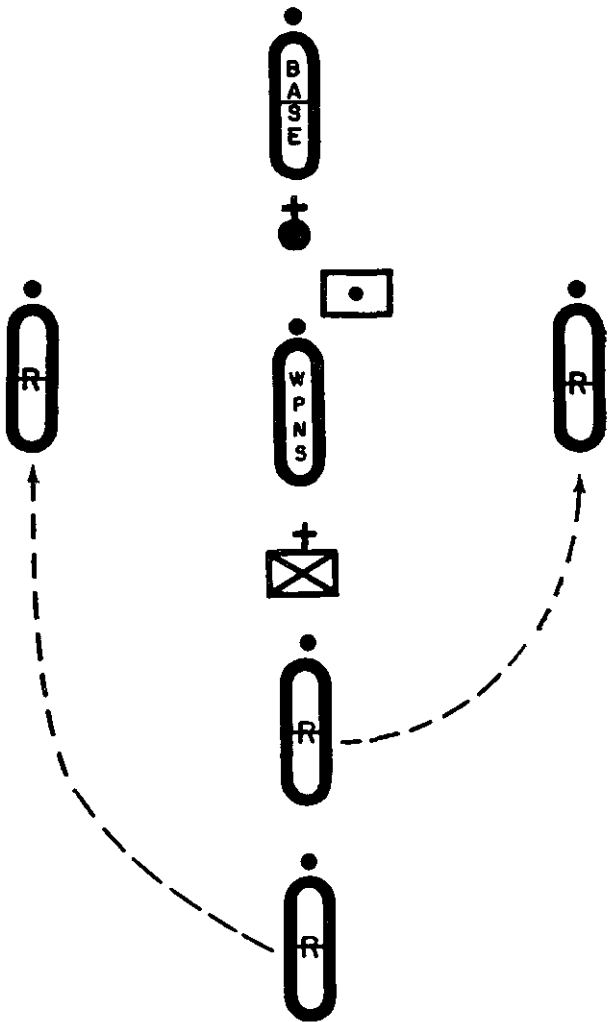

3 Column to wedge.

Figure 53—Continued.

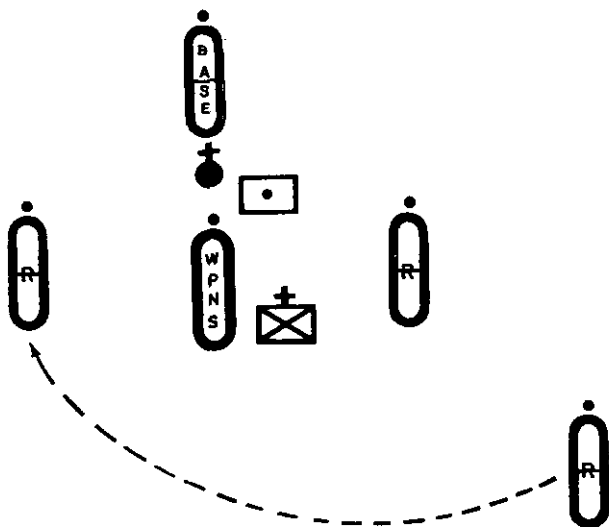

4 Echelon to wedge.

*Figure 53—Continued.*

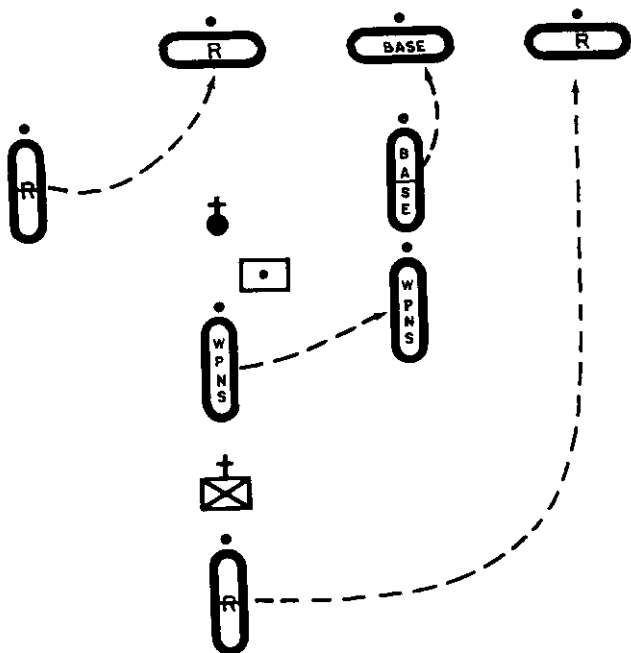

5 Vee to line.

Figure 53—Continued.

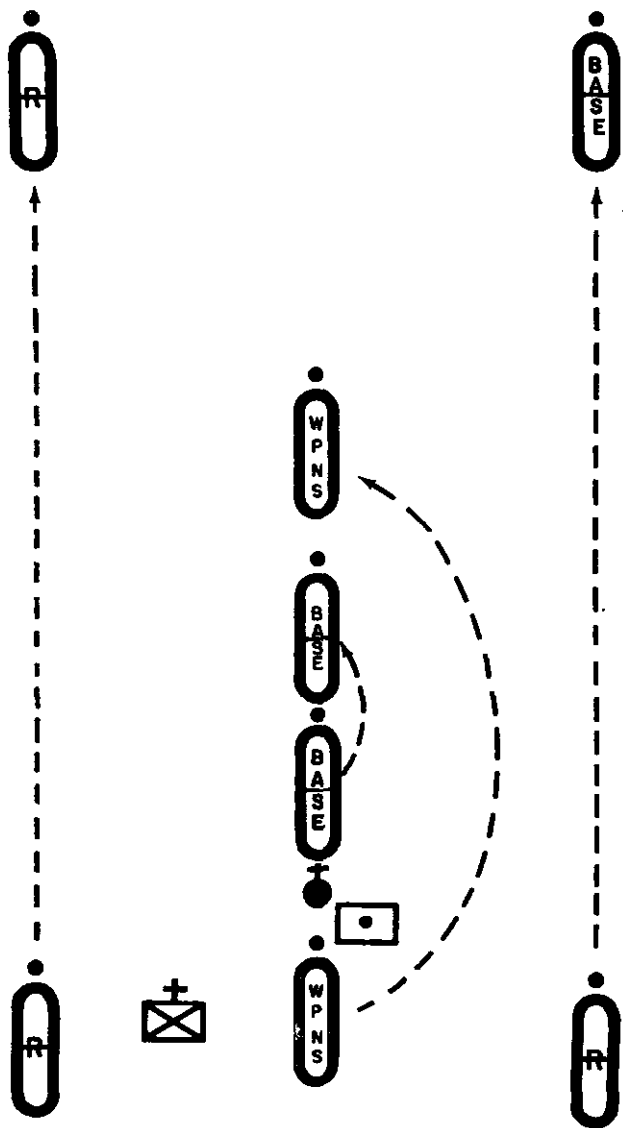

6 Wedge to vee.

Figure 53—Continued.

## **Section II. MOUNTED FORMATIONS, PLATOON**

### **5. General**

a. The formations for a rifle platoon in armored carriers closely approximate dismounted platoon formations. The mounted platoon formations shown here are presented as a guide and are not to be construed as the only possible arrangements of the elements of the platoon.

b. The formations described are similar to those used by tank platoons, facilitating the adoption of integrated mounted infantry-tank formations.

c. The platoon leader positions himself where he can best exercise the control. Since he can normally maintain better control from the lead vehicle, his position has been so indicated in the diagrams (figs. 54-60). The platoon sergeant is located as directed by the platoon leader. Locating him in the carrier with the weapons squad may not be appropriate in every situation.

d. In selecting a formation, the platoon leader considers security, control, flexibility, the terrain, and the combat formation of the tank platoon with which the platoon is operating (if appropriate). Formation changes, made to meet changes in the situation, are accomplished without halting the platoon. Formation changes are made generally as for dismounted formations (par. 4).

### **6. Loading and Dismounting**

a. *Loading.* Normally one squad rides in each carrier, and the tactical integrity of the squads

is maintained, though in some situations it may be desirable to have elements of the weapons squad separated. Additional personnel, such as those of platoon headquarters and a mortar FO party, are distributed in the platoon carriers as the platoon leader directs. Personnel are loaded to facilitate their deployment on dismounting. Fire teams (or a machinegun team and a rocket launcher team) normally sit opposite each other within the vehicle. The squad leader occupies the commander's cupola or, if the platoon leader or platoon sergeant is commanding his vehicle, sits next to the ramp. Fire team leaders *normally* sit next to the ramp.

*b. Dismounting Technique.* The rapid dismounting and deployment of the squad and the immediate establishment of control by the squad leader are essential. With the exception of the vehicle commander and driver, personnel are unable to see the terrain over which they are moving. Consequently, a degree of confusion and disorganization exists unless personnel are properly oriented and trained in their immediate actions after dismounting. The vehicle commander orients members of his squad immediately before they dismount, covering the following: enemy direction, direction each fire team will move, the dismounted combat formation which will be adopted, and the relative location of tanks or other friendly elements. Unit SOPs and training facilitate the effective dismounting and immediate employment of the squad.

## 7. Type Mounted Platoon Formations

a. The *column formation* (fig. 54) facilitates control and may be used when enemy contact is remote, when routes of advance are restricted, when maximum firepower of the carriers is desired to the flanks, or under conditions of reduced visibility.

b. The *line formation* (figs. 55 and 56) provides maximum firepower of the carriers to the front and facilitates the dismounting of infantry in an assault formation. Control is difficult unless visual contact is good. This formation may be used when moving across skylines or emerging from woods or smoke, to complete deployment of the platoon prior to dismounting, or when following tanks in a line formation.

c. The *wedge formation* (figs. 57 and 58) provides firepower of the carriers to the front and flanks and is easier to control than the line formation. It may be used when crossing large, open areas where dispersion of vehicles is desired, or when moving in an integrated wedge formation with tanks.

d. The *echelon formation* (figs. 59 and 60) provides firepower of the carriers to the front and echeloned flank, some lateral dispersion of vehicles, and is easier to control than the line formation. It is principally used when moving on an exposed flank in formation with an echeloned tank platoon.



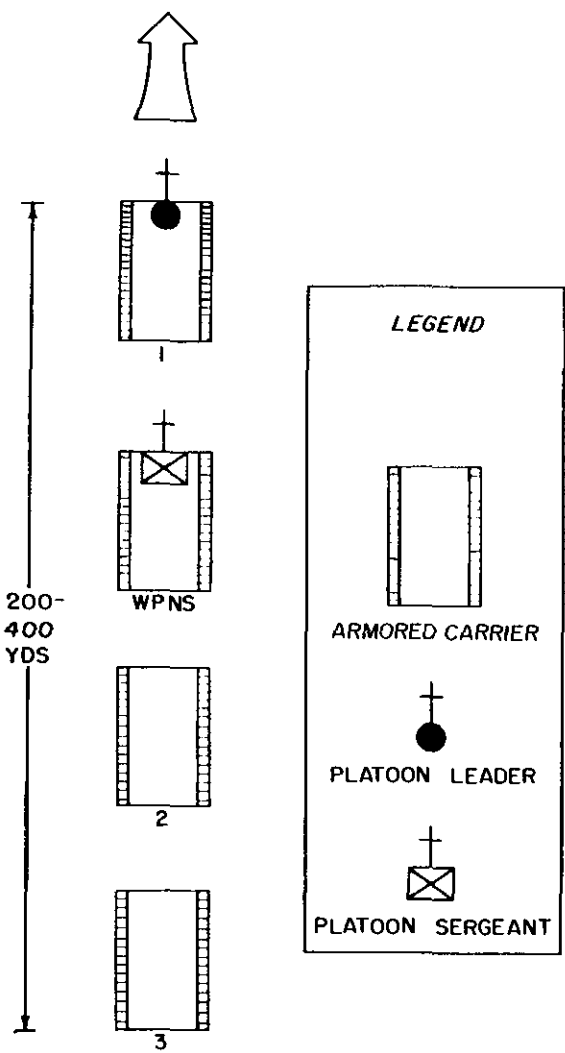

Figure 54. Column formation.

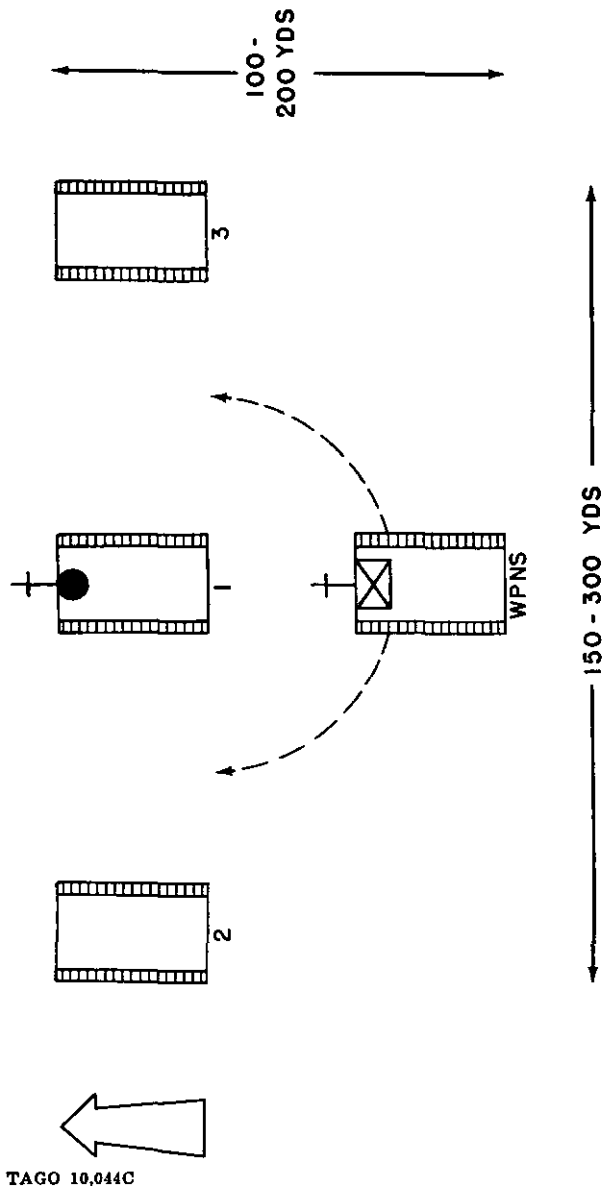

Figure 55. Line formation, variation 1.

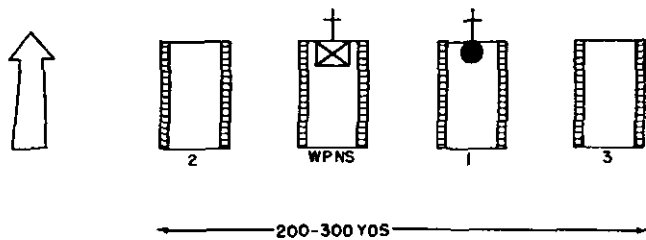

Figure 56. Line formation, variation 2.

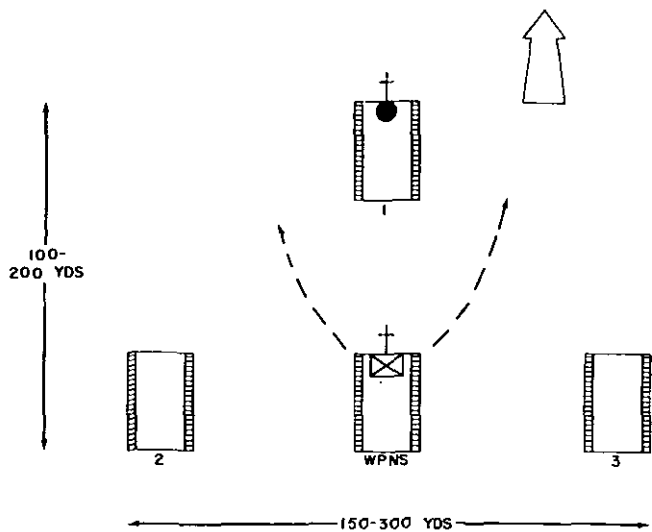

Figure 57. Wedge formation, variation 1.

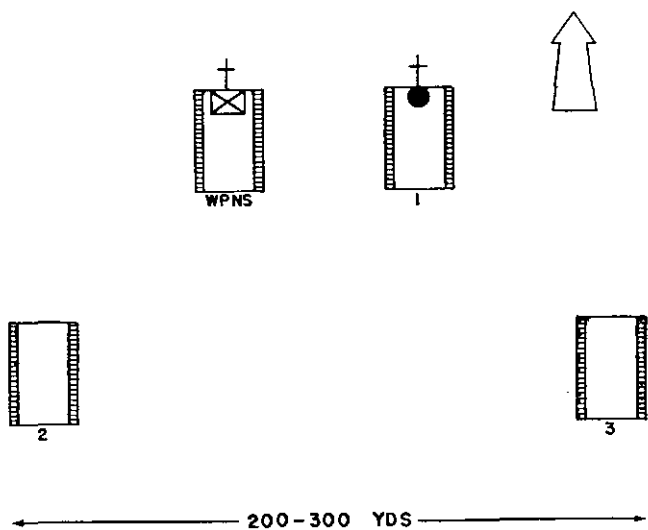

Figure 58. Wedge formation, variation 2.

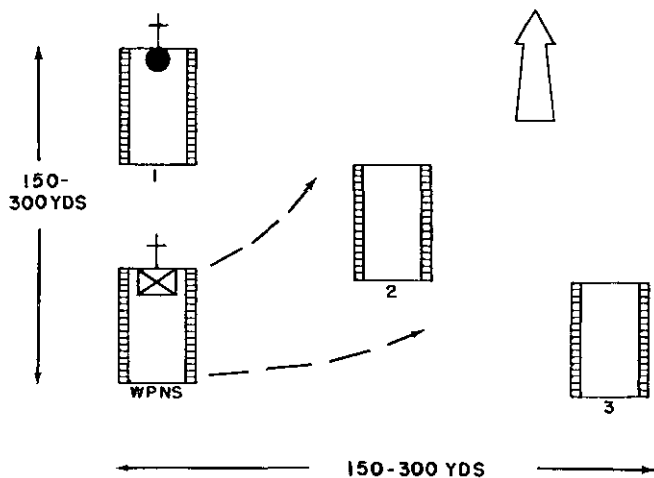

Figure 59. Echelon (right) formation, variation 1.

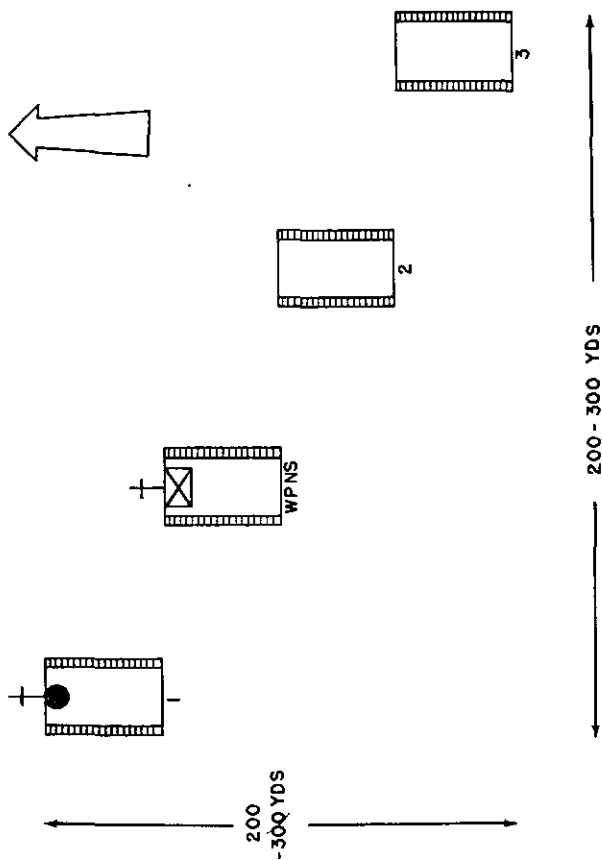

Figure 60. Echelon (right) formation, variation 2.

# APPENDIX VI

## BATTLE DRILL

---

### Section I. GENERAL

#### 1. Purpose and Scope

Battle drill eliminates the need for lengthy oral orders and allows rapid application of fire and maneuver. The purpose of battle drill is to provide a series of preplanned maneuvers in which elements of the squad and platoon are thoroughly trained, and which serve to accelerate combat action, optimize teamwork, and reduce to a minimum the orders necessary to effectively employ squads and platoons under fire. In surprise situations, rapidity of thought and action are essential to success. Though it will be necessary for the leader to make a rapid, informal estimate of the situation, the unit proficient in battle drill can go into action on receipt of a single command or, at most, fragmentary orders. Maneuvers presented in battle drill are used to close with the enemy and to destroy or capture him. Emphasis is placed on building firepower before maneuver is executed. The combat formations described in appendix V are used as a starting point in the execution of battle drill maneuvers.

## 2. Preliminary Training

The execution of battle drill maneuvers depends in great part on fundamental skills of the individual soldier as well as the teamwork generated in the conduct of instruction in combat formations. Prior to the training that must be conducted to achieve coordinated team play, individual skills of the soldier must be stressed to a high degree.

*a. Marksmanship.* The individual's ability to deliver an accurate volume of fire with his primary weapon is a most important fundamental. This skill is achieved in the present training programs, but the combat leader must impress upon his subordinates the importance of the well-aimed fires of each member of the unit to accomplish the mission.

*b. Combat Training.* The skills developed in individual combat training enable the soldier to recognize and use cover; to conceal himself while observing or firing on the enemy; to crawl toward the enemy when necessary; and to fire and maneuver toward a position in a series of rushes from one firing position to another. Proficiency in all of these skills must be achieved by the individual for him to contribute to the coordinated and effective team play of his squad.

*c. Battlefield Signals.*

- (1) Signals are used when oral commands or warnings are inadequate. Battle drill is directed toward the elimination of lengthy verbal orders. Consequently, each soldier must be thoroughly trained

in the use of arm and hand and whistle signals.

- (2) Arm and hand signals indicating that a movement is to be executed by a particular unit should be preceded by a signal designating the unit or units to accomplish the movement. Arm and hand signals are used habitually with oral commands throughout instruction in battle drill to insure that the men become thoroughly familiar with the meaning of the signal used.
- (3) During the stress of combat, sound should be combined with visual signals as the best medium available for a leader to transmit his orders. As the members of the squad and platoon become familiar with the arm and hand signals for the various "plays" of battle drill, whistle signals should supplement oral commands.

### **3. Instruction**

Initial orientation, which discusses the importance of battle drill and the part it plays in the overall success of a unit, is usually presented by the platoon leader or company commander. Instruction in the individual skills and presentation of the remaining portions of this appendix should be conducted by the squad leader. The order of the sections that follow is a logical sequence for training.



## **Section II. INDIVIDUAL BATTLE ACTION**

### **4. Exercises**

Individual battle action exercises train the soldier to utilize the best cover, to choose the best avenues of approach, to develop the ability to move forward while presenting a minimum target, and to locate enemy positions while rushing. They should be conducted so as to give each member of the rifle squad experience in movement over a wide variety of terrain. A large area should be selected containing stumps, logs, scrub brush, folds in the ground, and shellholes from which the soldier can choose firing positions during his movement. The individual should be forced to make instantaneous decisions as to firing positions, cover, and directions of advance. He should be able to see and not be seen when he interrupts his advance to select a position from which to fire. He should select a route forward that offers the best cover without unduly delaying his forward movement.

### **5. Duties of Squad Leader**

The exercises may be conducted on any varied terrain and should be controlled and supervised by the squad leader. Repeated instruction should be continued until all members of the squad have displayed proficiency. The individual should receive a critique by the squad leader after each running. This critique should cover his method of starting from a firing position, running from one firing position to another, choice and methods

of getting into positions, and the use of cover. Camouflaged Aggressor targets can be placed in the training area to test the individual's ability to locate the enemy during his movement.

### **Section III. ELEMENTARY FIRE AND MANEUVER**

#### **6. Purpose**

*a.* Exercises in elementary fire and maneuver develop within the rifle squad the instinct and timing necessary for coordinated teamwork in the attack. Realistically conducted, they enable the members of the squad to practice the principles of team play in attacking and assaulting a position. Aggressiveness and teamwork are the keys to the success of the units most closely engaged.

*b.* Only by repeated execution of fire and maneuver on these basic courses can the rifle squad develop the instinct and timing to operate smoothly as a team. It must train under stress of physical exertion, fatigue, and hazardous conditions; it must operate over all types of terrain to achieve that unity of action in which some men will always be in a position to fire while other members are advancing.

*c.* Courses for fire and maneuver exercises should be constructed in areas of varying terrain. The exercises should be conducted initially in normal training areas using blank ammunition,

with the final exercises being run with live ammunition in a range area.

## **7. Conduct of Training**

*a.* Exercises in elementary fire and maneuver should be conducted in two separate phases.

- (1) The first phase (fig. 61), in which two men at a time participate, is restricted to an area about 25 to 30 yards wide. There is a minimum of 10 yards between men. The men advance in rushes from one firing position to another. One man starts the advance by rushing to a firing position while the other man takes up the fire against the enemy. Then the second man rushes to a more advanced position while the first man takes up the fire. This action continues until both men arrive within hand grenade range of the targets. Here the first man throws a simulated hand grenade and both men assault simultaneously.
- (2) In the second phase (fig. 62), each fire team is divided into two groups (A and B). This exercise is conducted over an area about 100 to 120 yards wide and 250 yards long. One fire team participates at a time, while the other fire team observes. A minimum of 10 yards between men is maintained. The team leader controls one group, and one of the men in the other group is designated

as its leader. The two groups move toward a starting position in parallel columns, as if they were the leading fire team in a squad column. At a signal indicating that the groups have come under effective enemy fire, they hit the ground and return fire immediately. By individual rushes, the team members move to positions generally on line with the team leader. As soon as the enemy is located, the team leader in Group A starts the advance by rushing a short distance toward the objective, covered by the fire of the other members of Groups A and B. When the team leader reaches a new position and takes up the fire, No. 3 of Group A moves up to a firing position, begins to fire, and is followed by No. 5 of Group A. When all members of Group A have taken up new firing positions, Group B starts its advance, begun by No. 4 and followed to a new firing position by No. 6. Each of the groups alternate forward in this manner until they come within hand grenade range of the enemy position. At the signal of the team leader, all members of Group A throw simulated hand grenades. When the grenades pop, both groups move toward the position, forming an assault line, moving at a rapid walk, and firing well directed shots from the underarm or shoulder position. A

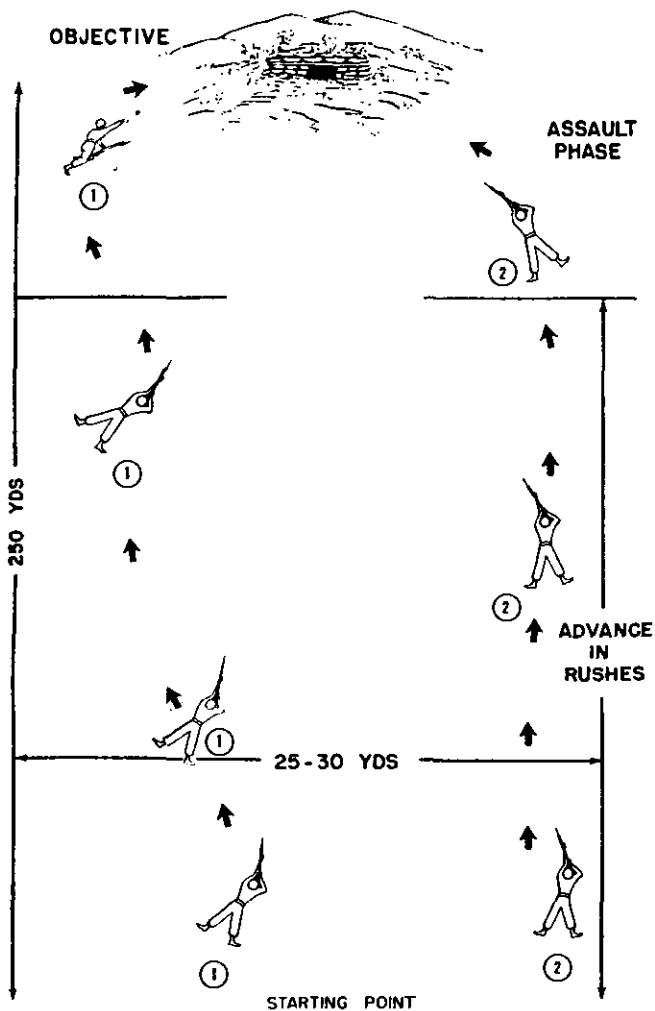

Figure 61. Elementary fire and maneuver.

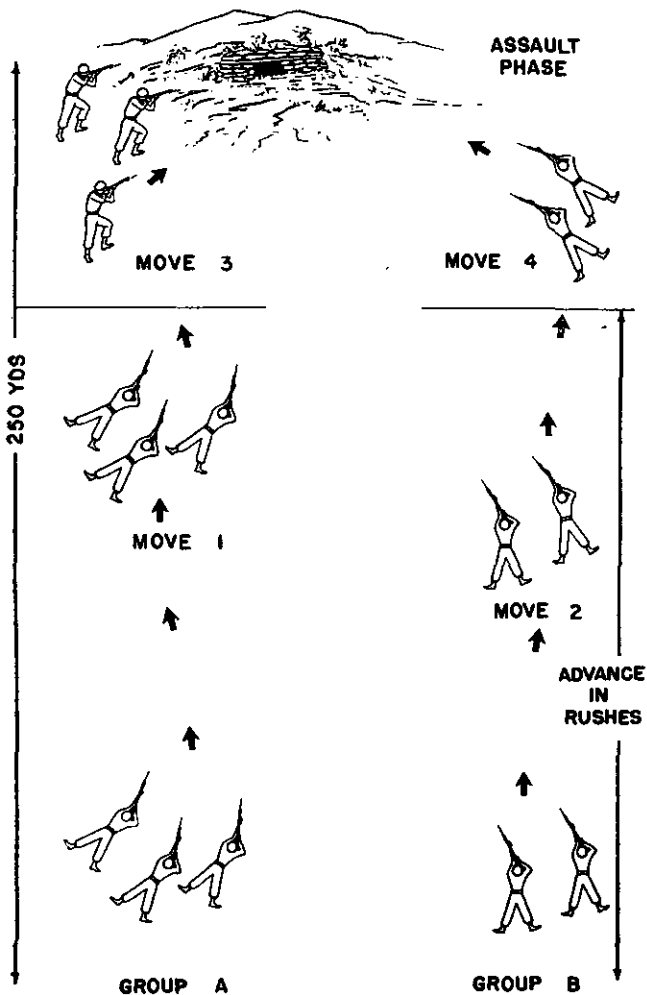

Figure 62. Team fire and maneuver.

similar exercise is conducted using the BRAVO team.

b. These exercises may be conducted over normal training areas, using blank ammunition and an Aggressor detail, or on a firing range using live ammunition and silhouette targets. The exercise should be controlled and supervised by the squad leader. Groups and teams should be alternated until each member of the squad displays proficiency in every role and in each position within the squad. A critique should be conducted at the conclusion of each running, covering timing, teamwork in movement and in the assault, selection of firing positions, proper methods of rushing, and best utilization of the terrain. Errors by individual members of the squad should be corrected immediately at the conclusion of the exercise. Men making errors should receive additional instruction before the squad advances to battle drill training.

## **Section IV. SQUAD BATTLE DRILL**

### **8. General**

The rifle squad with its two fire teams is particularly well suited for battle drill. This organization permits the squad leader to use one team to maneuver while the other supports by fire. Similarly, the squad can advance by bounds over exposed areas, using one fire team to cross the area first while the other is in position to cover its movement by fire if necessary. Using battle

drill plays, the squad leader can direct and control the actions of his squad with minimum reliance on verbal instructions.

## **9. Squad Teams**

*a.* The organization of the rifle squad into two fire teams, as shown in figure 39, provides the squad leader with two like elements with which to execute fire and maneuver. Essentially, one fire team is used as the maneuver element, while the other is used as the fire support element. The role of each fire team may change during the conduct of any particular action. For example, if the maneuver element is prevented by enemy action or terrain from closing with the enemy, it assumes the fire support role to cover the advance of the other team, which then becomes the maneuver element.

*b.* Although the rifle squad is organized into two like teams, this organization does not prevent the squad leader from altering the organization of his maneuver and fire support elements to conform to a specific situation. When the terrain offers excellent firing positions and more firepower is required in the fire support element than can be provided by one fire team, the squad leader may designate the numbers 4, 6, 9, and 11 men and one of the fire team leaders to act as the fire support element, with the remainder of the squad acting as maneuver element. This subdivision of the squad takes time to accomplish, and the two elements formed are not interchangeable. In addition, the precision with



which these elements operate will usually not be as great as when fire teams are used. However, such a subdivision of the squad may be indicated in some situations.

## **10. Fire Support Element**

*a.* The fire support element assists the maneuver element in its advance toward the enemy position by engaging all known or suspected targets. It continues its fire until masked by the maneuver element.

*b.* This element is aggressive in its actions. While delivering fire on the enemy, it continues to move closer to the objective if such action is possible without reducing the concentration of fire. Such movement is normally accomplished through use of individual rushes. When the maneuver element masks its fires, the fire support element moves forward immediately to join in the assault or assist in consolidation.

## **11. Maneuver Element**

*a.* The mission of the maneuver element is to close with and destroy or capture the enemy. It advances under the close fire support of the fire support element.

*b.* The maneuver element's principal job is to maintain the advance toward the enemy. It uses available cover and concealment to the maximum. It may move in a series of rushes, thereby permitting its individual members to fire from advantageous positions along the route of advance, or it may advance by crawling, if the

situation so dictates. Regardless of how it moves, it must continue to advance.

*c.* If terrain permits, the maneuver element may be able to move forward under cover to positions within hand grenade range of the enemy. The fire support element continues to engage targets, ceasing its fire and maneuvering only when the maneuver element assaults and masks its fire.

## **12. Control of the Squad**

*a.* The squad leader effects control assisted by the team leaders. The organization of the squad into fire teams in no way prevents the squad leader from directly controlling individual squad members. The squad and team leaders display positive and forceful leadership when executing battle drill plays.

*b.* The squad leader gives the necessary command or signal to execute the desired battle drill play. Team leaders initiate the action directed by the squad leader. If necessary, they repeat the command or signal. Team leaders act as fighter-leaders, controlling their teams primarily through example. Team members base their actions on their team leaders. Throughout the action, team leaders exercise such positive control as is necessary to insure that their teams function as directed. The squad leader locates himself where he can best control and influence the action.

*c.* In a situation in which the squad is brought under effective small-arms fire while advancing,

certain actions are automatic. Those individuals in position to return fire do so immediately. Members of the leading fire team move by individual rushes to positions generally abreast of their team leader and attempt to gain fire superiority over the enemy. While this action is occurring, the squad leader quickly makes an estimate of the situation and formulates a plan. His plan provides for gaining fire superiority before attempting to maneuver. In some situations, one fire team may immediately gain fire superiority, permitting maneuver by the other team. In other situations, both fire teams may be required to gain fire superiority, permitting maneuver only by individual rushes. The squad leader gives the necessary signal or command to implement his plan. The team leader of the maneuver element initiates the action of his team by moving in the desired direction. He selects the route to be followed, based on the command or signal of the squad leader. Other members of his team base their actions on the team leader, moving by individual rushes as necessary.

### **13. Squad Maneuvers**

a. Battle drill maneuvers depicted in the following paragraphs provide for movement of the squad by bounds when enemy contact is imminent and for executing certain maneuvers when enemy contact has been established. Once the enemy has been located, all squad maneuvers can be grouped into three basic battle drill plays—maneuver left, maneuver right, and frontal

attack. These maneuvers can be executed from the various formations in which the squad moves.

*b.* The *techniques* used in executing battle drill plays are emphasized in the following paragraphs. The *tactics* used—that is, the determination of which play is to be used in a particular situation—must be decided by the squad leader based on his rapid estimate of the situation. He quickly considers such factors as the terrain (covered and concealed routes available for maneuver; positions available for fire support), enemy dispositions and capabilities, his own dispositions, and the courses of action open to him. When the resistance is isolated and has exposed flanks, the squad leader attempts to move his maneuver element over a covered and concealed route to strike the enemy resistance in the flank or rear. Conditions may preclude such maneuver, however, and a frontal attack may be required. The course of action selected is the one which offers the most promise of success.

#### **14. Movement by Bounds**

*a.* When not in direct contact with the enemy, the squad moves with the greatest degree of security consistent with the assigned mission and the requirement for speed. When continuous movement is required, this security may be facilitated by moving in squad column with one fire team following the other at a prescribed distance. Other conditions may permit the squad to advance its fire teams by bounds.

*b.* Movement by bounds may be appropriate

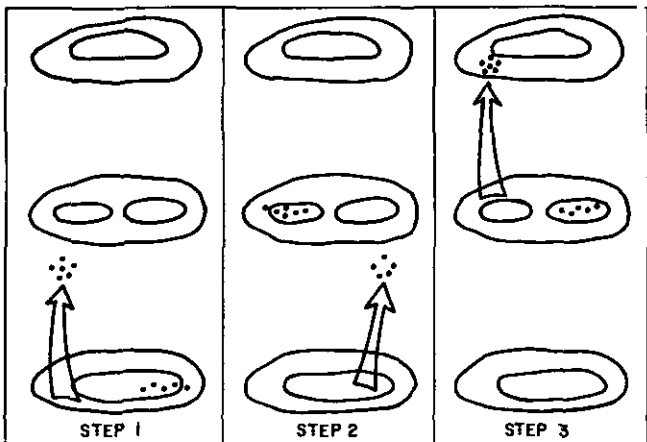

*Figure 63. Movement by successive bounds.*

when the squad must cross an exposed area which may be covered by enemy fire. In using this technique, the squad leader designates one fire team to occupy firing positions from which it can cover the movement of the other team across the open area. The team in position normally does not fire unless enemy are detected. After the fire team has crossed the open area, the team in position is signaled to move forward. Such movement may be continued with teams advancing either by successive bounds (fig. 63) or by alternating bounds (fig. 64).

### **15. Bottle Drill Plays From Squad Column (Fire Teams in Column)**

To execute maneuver right, maneuver left, or a frontal attack, the squad leader gives the ap-

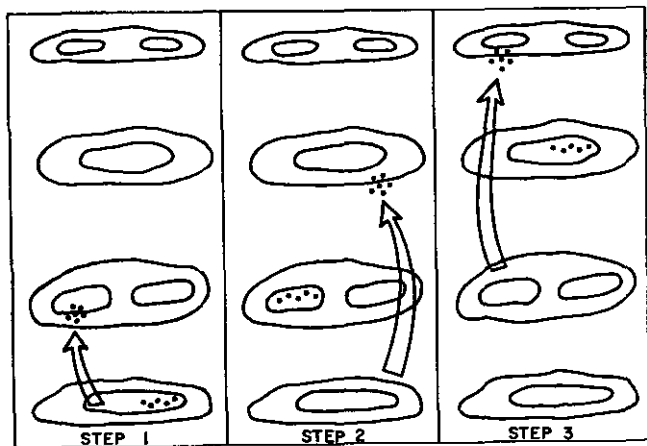

Figure 64. Movement by alternating bounds (leapfrogging).

appropriate command and signal, and the squad executes the plays as shown in figures 65-68.

## 16. Battle Drill Plays From Squad Column (Fire Teams Abreast)

a. *Maneuver Right.* To execute maneuver right, the squad leader commands and signals MANEUVER RIGHT, and the squad executes the play as shown in figure 69.

b. *Maneuver Left.* To execute maneuver left, the squad leader commands and signals MANEUVER LEFT, and the squad executes the play as shown in figure 70.

c. *Frontal Attack.* To execute frontal attack, the squad leader commands and signals FRONTAL ATTACK, RIGHT (LEFT), and the squad

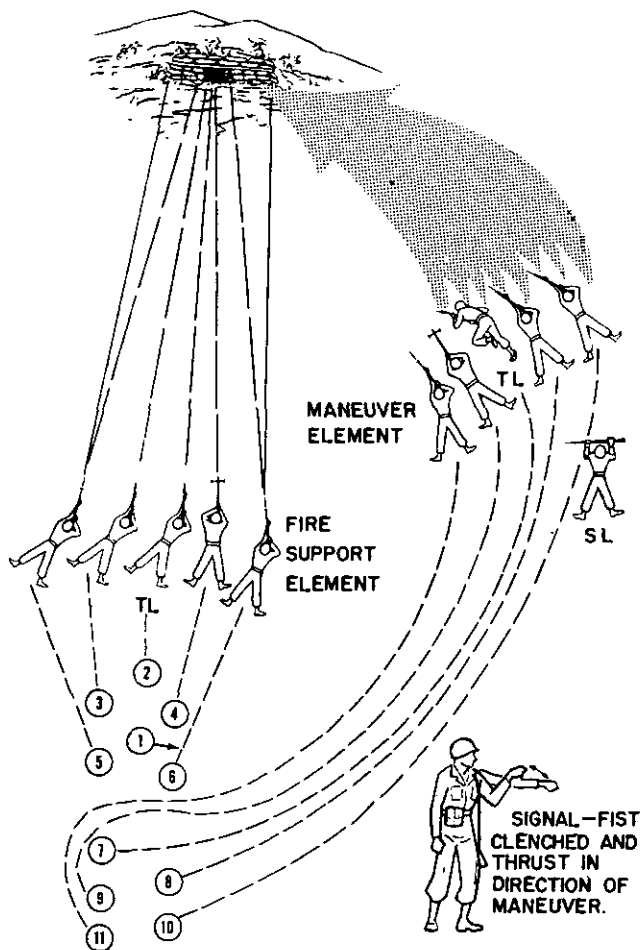

Figure 65. Maneuver right from squad column (fire teams in column).

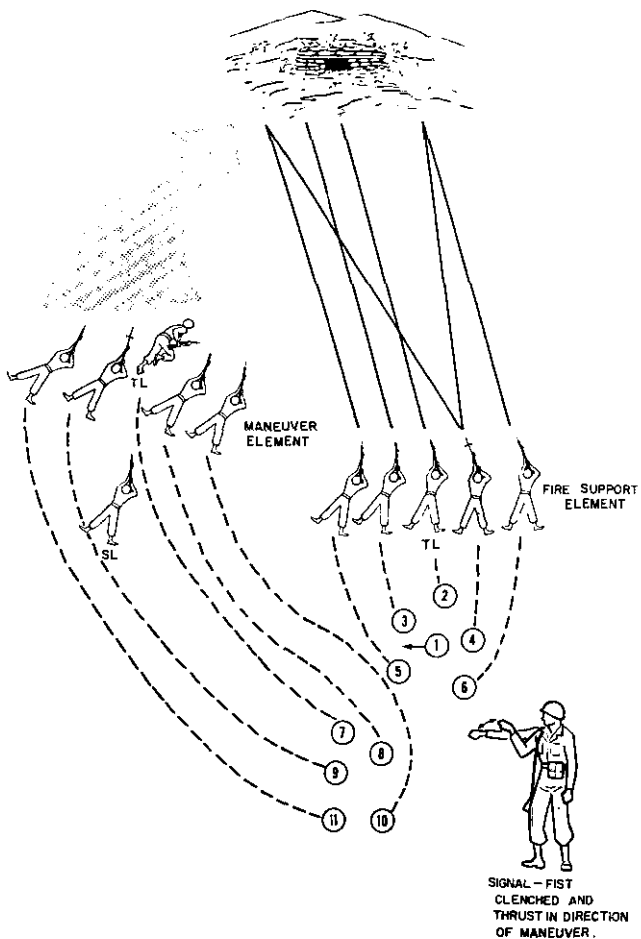

Figure 66. Maneuver left from squad column (fire teams in column).



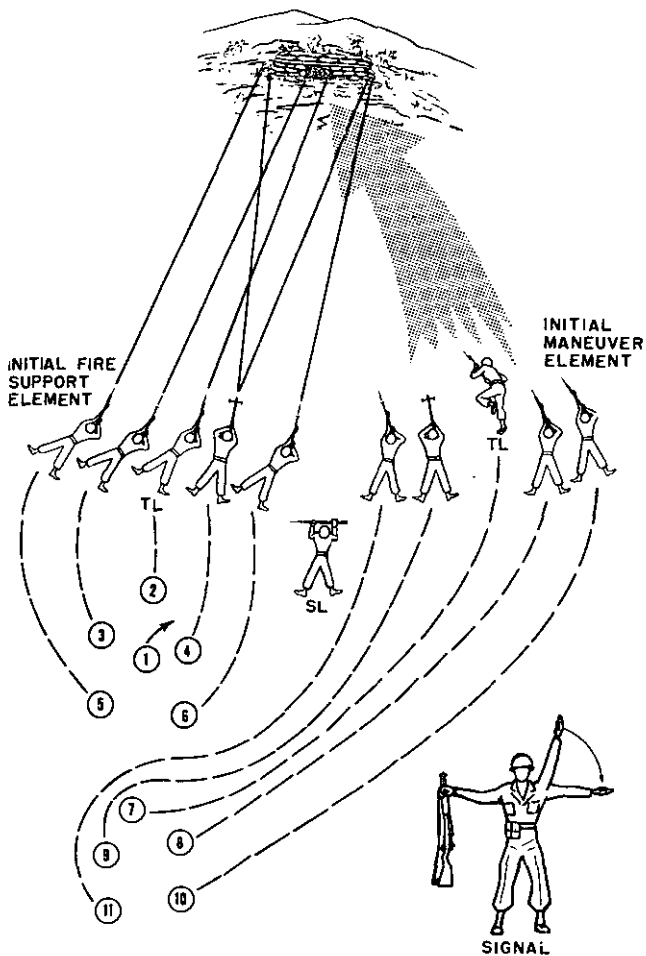

Figure 67. Frontal attack, right, from squad column (fire teams in column).

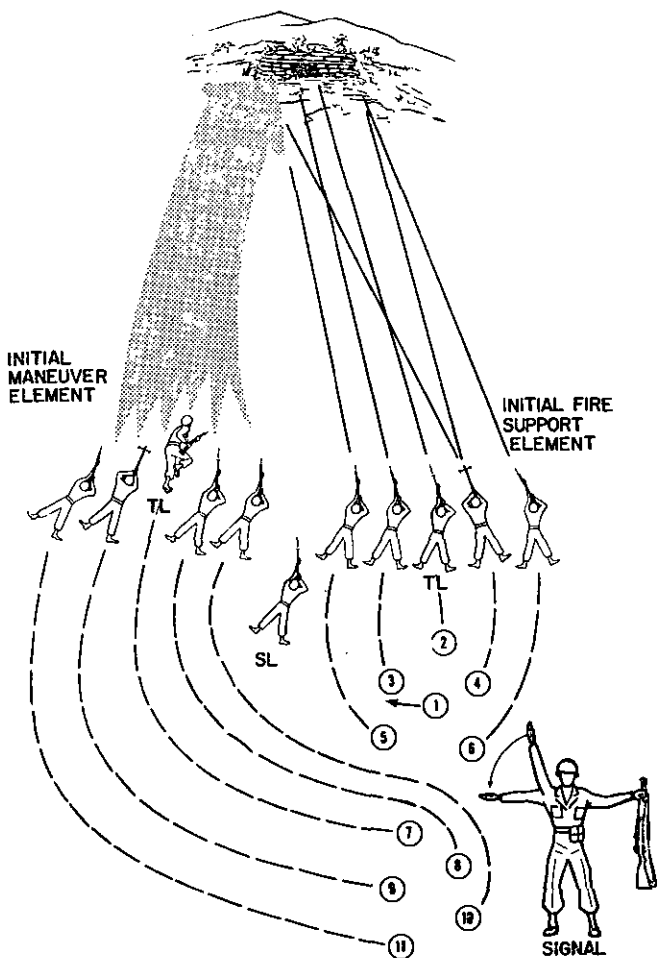
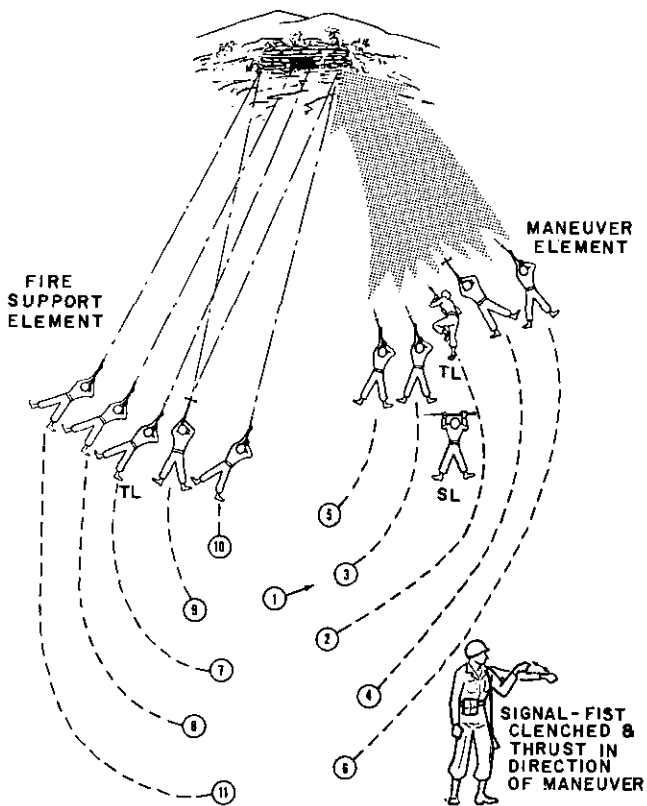

Figure 68. Frontal attack, left, from squad column (fire teams in column).



*Figure 69. Maneuver right from squad column (fire teams abreast).*

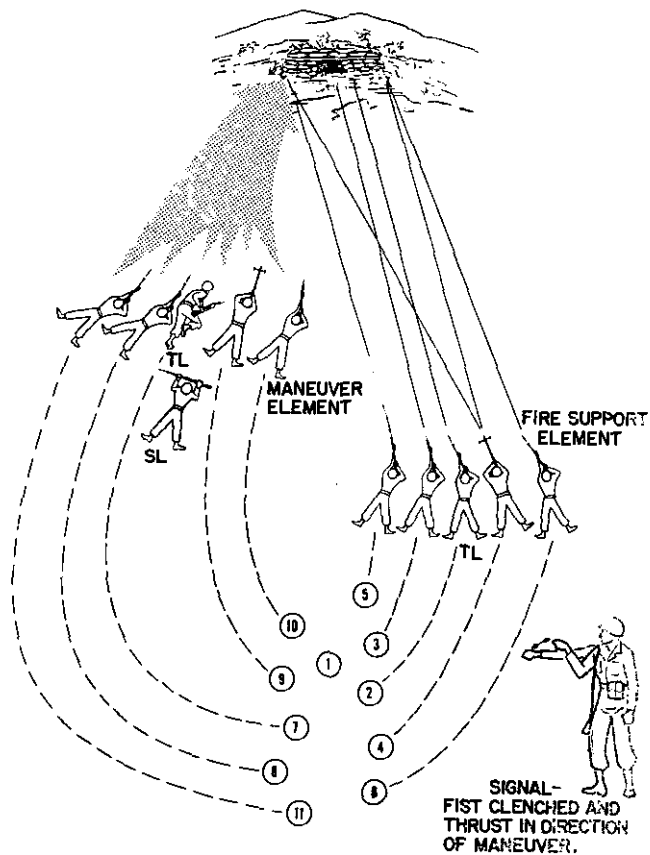

Figure 70. Maneuver left from squad column (fire teams abreast).

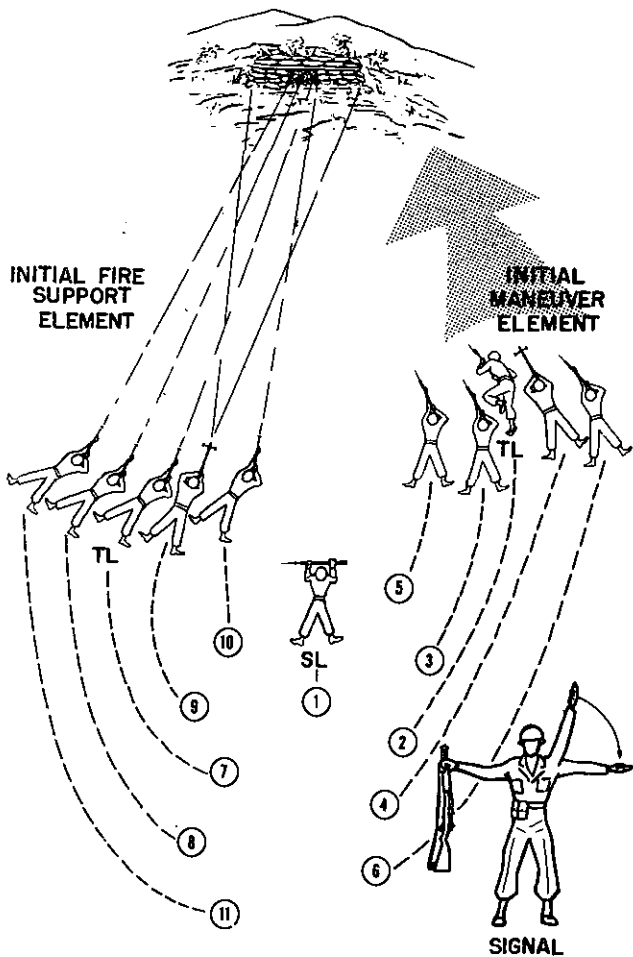

Figure 71. Frontal attack, right, from squad column (fire teams abreast).

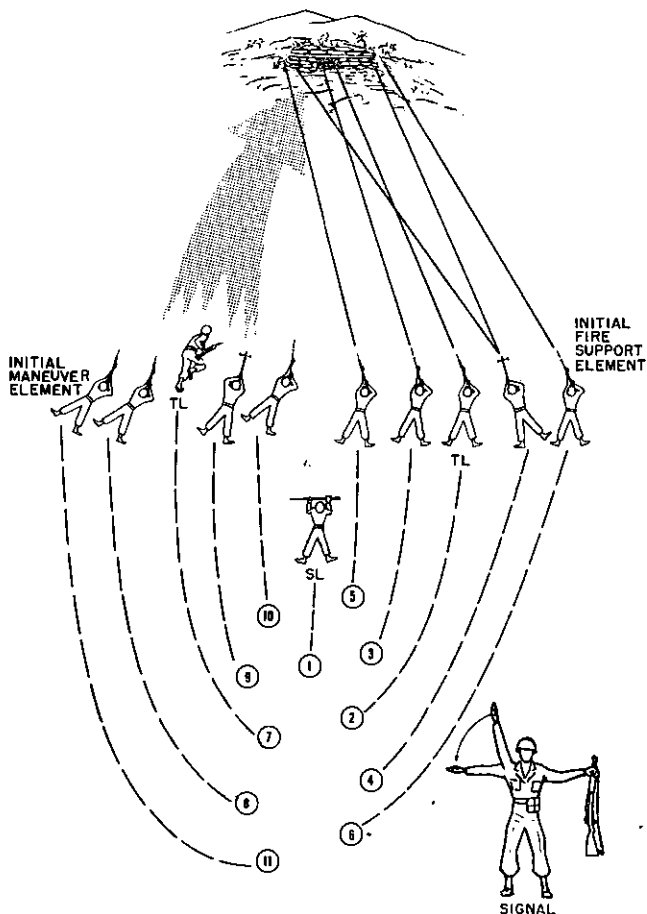

Figure 72. Frontal attack, left, from squad column (fire teams abreast).

executes the play as shown in figures 71 and 72, as appropriate.

### **17. Battle Drill Plays From Other Squad Formations**

*a.* Battle drill plays can be executed from the as skirmishers formation in a manner similar to that depicted in figures 71 and 72. Either fire team may be used as the maneuver element initially, depending primarily on the terrain and enemy dispositions. The maneuver executed will usually be a frontal attack, since disengaging a fire team to maneuver to either flank will normally be very difficult.

*b.* Battle drill plays can be executed from the squad file formation generally as depicted in figures 65 through 68, inclusive.

## **Section V. PLATOON BATTLE DRILL**

### **18. General**

*a.* Platoon battle drill provides a guide for instruction in platoon maneuvers or plays so that the platoon leader may deploy his rifle squads when conditions of combat prevent him from exercising desirable verbal control. This drill designates the maneuvers that the platoon may use in deploying from various combat formations, and provides a uniform method of conducting drill in this deployment.

*b.* The platoon leader's task is to see that his squads are committed to action at the proper

time, over the most advantageous terrain, and with maximum coordination between squads. Once the rifle squads know the objective and are deployed in the position from which to attack, they execute their forward movement either by forming an assault line under effective supporting fires, or as outlined for squad battle drill.

c. The platoon leader makes an estimate of the situation and issues fragmentary orders that permit both the effective employment of the platoon in any terrain and the use of supporting weapons. When conditions of combat preclude the issuance of verbal orders, the platoon leader employs arm and hand or whistle signals, and the squads execute the maneuvers as indicated in paragraph 19.

## **19. Platoon Maneuvers**

It would be impossible to plan fixed maneuvers that the platoon leader could use to meet any situation on any terrain. There are, however, certain basic deployments that the platoon leader may adapt to meet most of the situations that he will encounter. Basically, when the rifle platoon meets enemy resistance en route to the objective, it can envelop left, envelop right, or make a frontal attack.

a. *Envelop Left.* To execute envelop left, the platoon leader commands and signals, ENVELOP LEFT, and the platoon executes the play as shown in figure 73.

b. *Envelop Right.* To execute envelop right, the platoon leader commands and signals, EN-



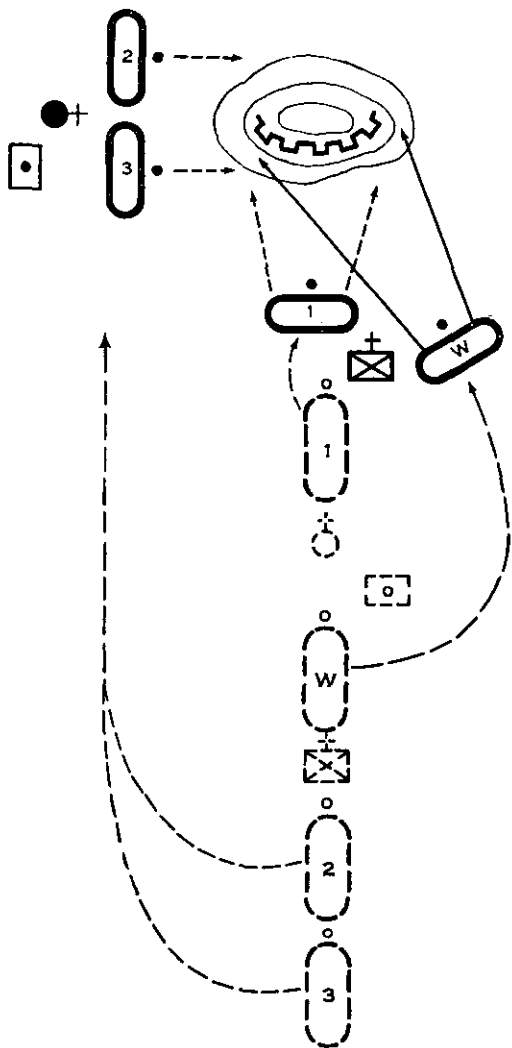

1 Envelop left from platoon column.

Figure 73.

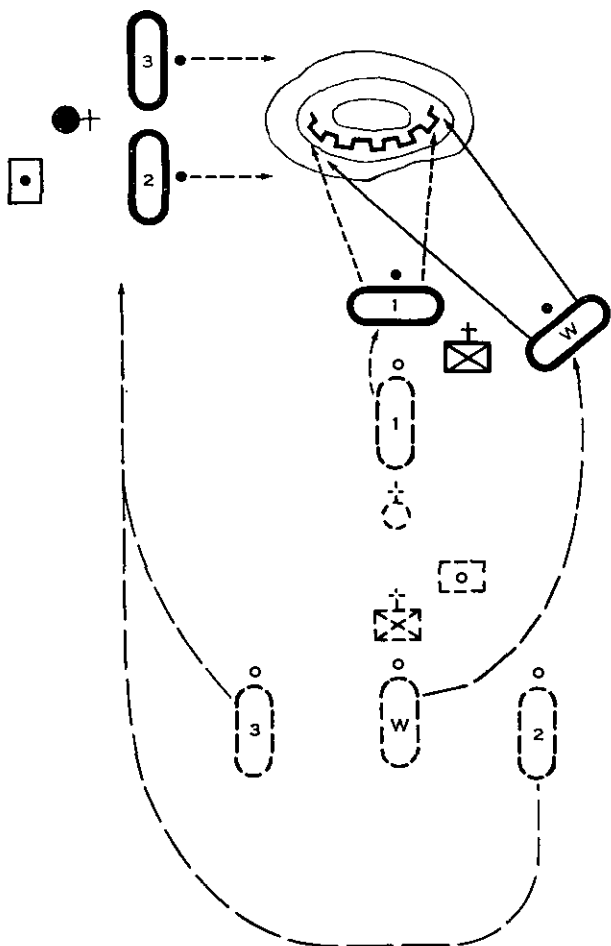

2 Envelop left from platoon wedge.

*Figure 73—Continued.*

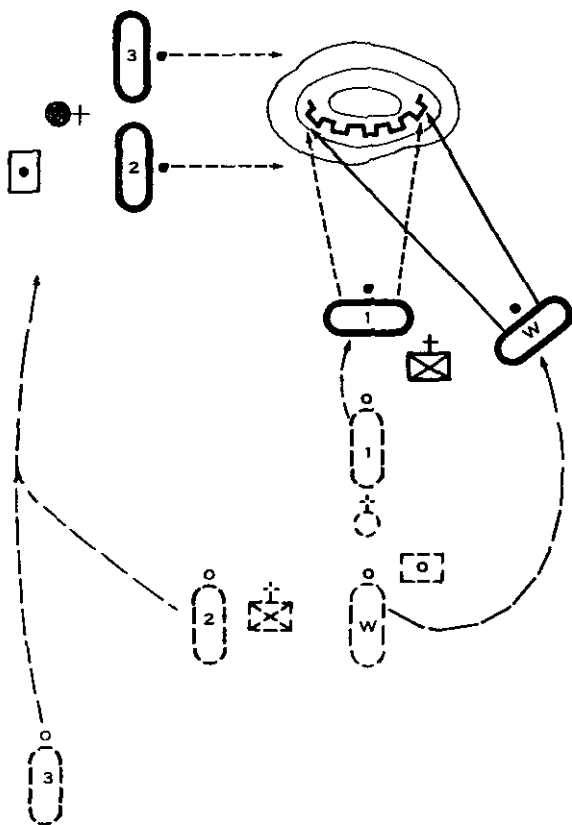

3 Envelop left from platoon echelon.

Figure 73—Continued.

VELOP RIGHT, and the platoon executes the play as shown in figure 74.

c. *Frontal Attack.* To execute frontal attack, the platoon leader commands and signals, FRON-

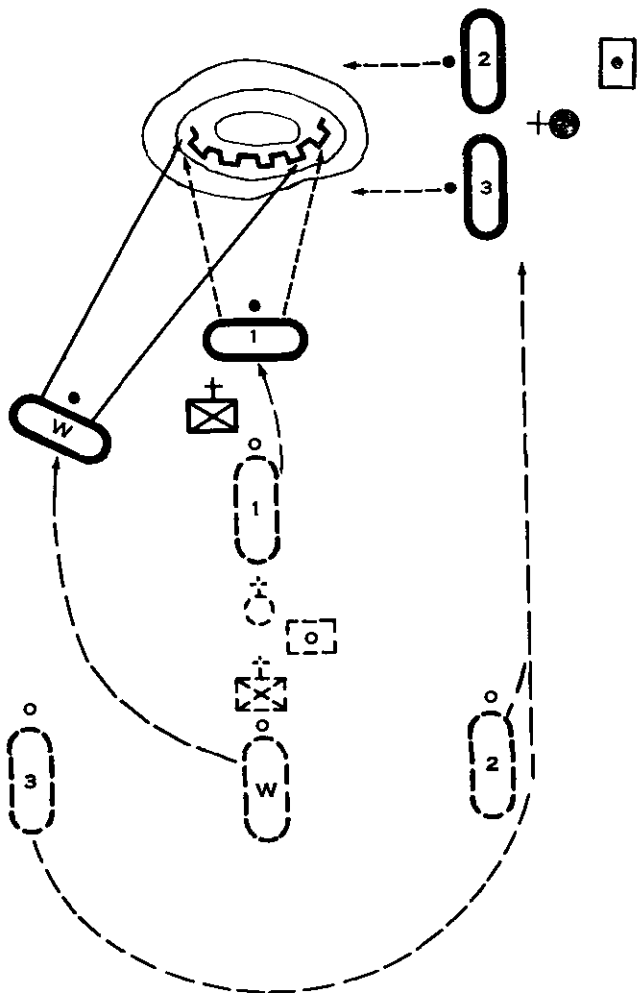

1 Envelop right from platoon wedge.

*Figure 74.*

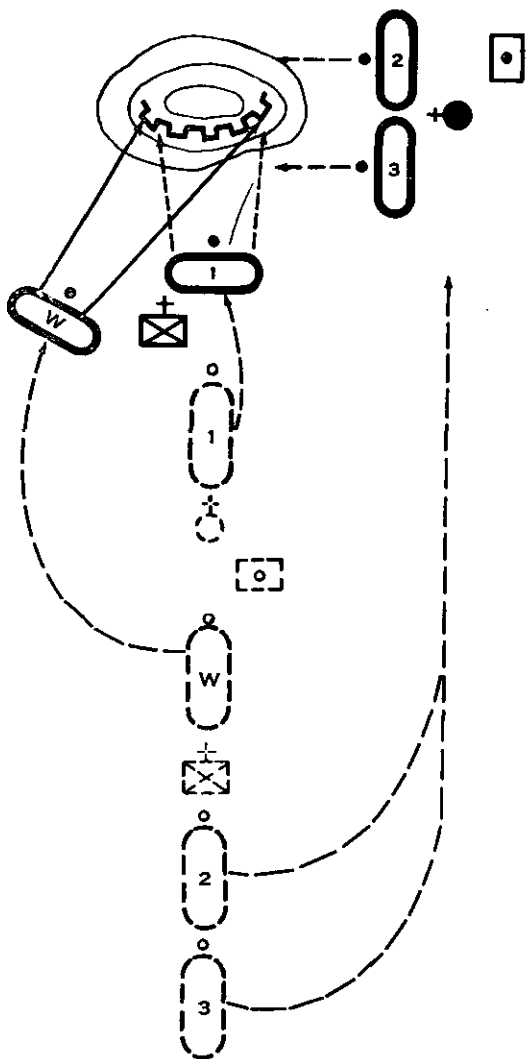

2 Envelop right from platoon column.

Figure 74—Continued.



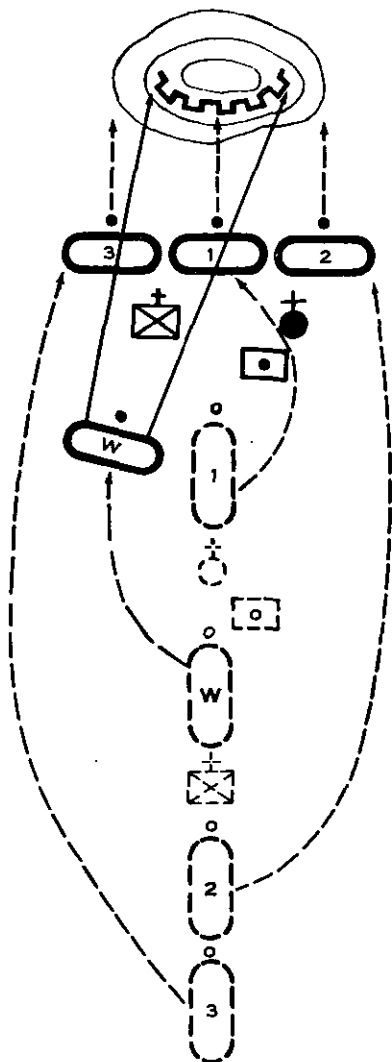

1 Frontal attack from platoon column.

Figure 75.

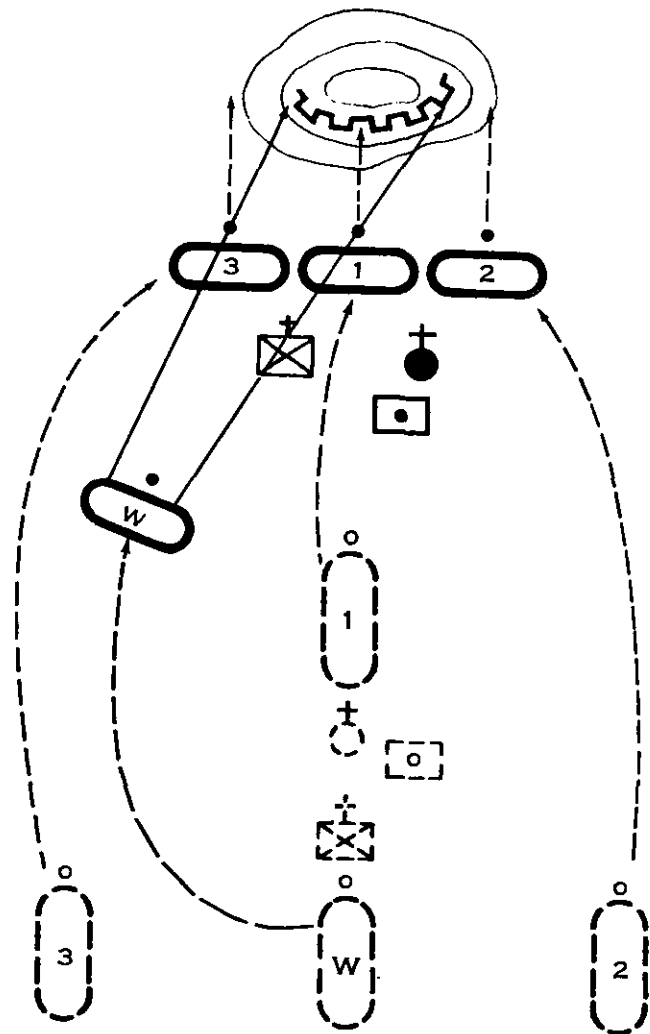

2 Frontal attack from platoon wedge.

Figure 75—Continued.



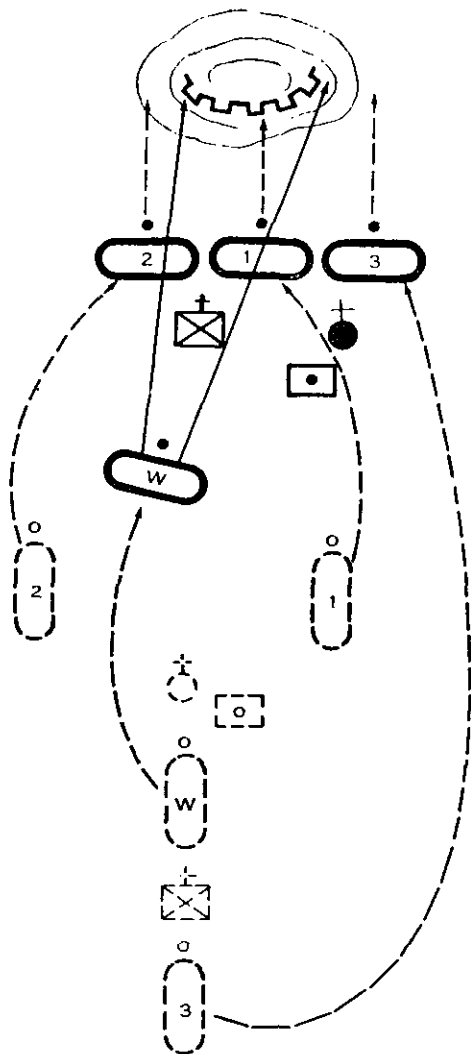

3 Frontal attack from platoon vee.  
*Figure 75—Continued.*

## **20. Conduct of Training**

Drills in platoon maneuvers should first be executed at a walk on level, open terrain. Speed of movement is increased as the platoon training progresses. Repeated exercises are conducted on various types of terrain. These repetitive exercises enable the squads to execute the movements smoothly, with coordination and teamwork between units.

## **21. Rifle Squads**

The rifle squad leaders must, upon receiving a signal or order from the platoon leader, take charge of their squads by signalling and commanding CHANGE DIRECTION or FOLLOW ME, and set the example by moving in the desired direction. The squads move in formation under cover, or by short rushes, until they are able to take the enemy under effective fire. Here they either form an assault line under supporting fires, or execute squad battle drill.

## **22. Weapons Squad**

The weapons squad leader must watch for any signal or order from the platoon leader directing him to emplace his weapons where he can effectively support the rifle squads in their attack, or directing him to accompany the maneuver element until such positions become available. Weapons are employed as discussed in paragraphs 72 through 74.

### **23. Attached Crew-Served Weapons**

The rifle platoon may become the basis for a variety of small unit task force organizations. When attachments are made, the platoon leader instructs the attached leaders in advance on their employment should he find it necessary to execute a platoon battle drill play. The attachments that are committed with the maneuver element come under the direct supervision of the platoon leader.

## INDEX

---

	Paragraphs	Page
Advance guard	34, 36, 40	48, 53, 59
Advance guard minus	35	50
Advance party	35	50
Air attack, actions against	17	27
Airborne assault:		
Assembly and reorganiza- tion	198	350
Attack	199	351
Ground tactical plan	192	338
Landing	197	349
Marshaling	195	346
Orders	188	334
Organization	191	337
Preparation	187	333
Reconnaissance	189	336
Responsibility during movement	196	349
Airhead line	192	338
Ammunition	215	372
Ammunition distributing point	13, 211	22, 368
Antitank squads:		
Displacement	74	125
Firing positions	74	125
Personnel, duties	8	15
Armored carriers, employment	87	151
Armorer, duties	6	9
Assault	61	94
Assault echelon	191	337
Assault line	50	71
Assembly area	47	68
Assembly area outpost	128	222

	Paragraphs	Page
Attached weapons, use . . . . .	58	89
Attack:		
Conduct of:		
Assembly area to LD..	60	93
Company commander..	59	92
LD through assault..	61	94
Preparation for:		
Assembly area .....	47	68
Company commander, actions .....	46	67
Company preparation .	48	69
Attack formations .....	52	79
Attack position .....	50	71
Avenues of approach .....	21	29
Axis of advance .....	50	71
Barrages .....	132	228
Barriers .....	122	212
Battle area .....	123	215
Battle drill:		
Elementary fire and maneuver . . . . .	app VI	435, 436
Individual battle action .	app. VI	434
Platoon .....	app. VI	456
Preliminary training .....	app. VI	432
Squad .....	app. VI	440
Blocking position . . . . .	123	215
BMNT .....	20	29
Boundaries .....	130	223
Check points .....	50	71
Class I-V .....	212-215	369
Combat formations:		
Dismounted:		
Platoon . . . . .	app. V	411
Squad .....	app. V	400
Mounted:		
Platoon .....	app. V	423
Combat outpost line .....	126	217
Command post .....	54, 138, 142	84, 243, 267

	Paragraphs	Page
<b>Communication :</b>		
Equipment .....	26	39
Uses .....	25	37
Communication chief, duties.....	6	9
Company clerk, duties .....	6	9
Company commander, duties.....	6	9
Company supply area .....	211	368
Concentrations .....	132	228
Consolidation .....	55, 63	85, 99
Contact points .....	50	71
Control, during movement.....	31	46
<b>Control measures:</b>		
Assault line .....	50	71
Attack position .....	50	71
Axis of advance .....	50	71
Check points .....	50	71
Contact points .....	50	71
Direction of attack .....	50	71
Line of departure .....	50	71
Mechanized attack .....	85	147
Objectives .....	50	71
Phase line .....	50	71
Time of attack .....	50	71
Zone of action .....	50	71
Corridors .....	21	29
Counterattack plan .....	137	242
Counterintelligence .....	23	34
Cover and concealment .....	21	29
Critical terrain .....	21	29
Cross compartment .....	21	29
<b>Defense:</b>		
Barrier plan .....	132	228
Boundaries .....	130	223
Concept .....	121	212
Considerations .....	122	212
Counterattack plan .....	137	242
Daylight .....	144	269
Depth .....	130	223

	Paragraphs	Page
<b>Defense—continued</b>		
Fire plan .....	132	228
Frontage .....	130	223
In depth .....	122	212
Night .....	145	273
Organic and attached		
weapons .....	134	236
Organization of ground .....	136	241
Perimeter .....	148	277
Platoon areas .....	131, 138	225, 243
Reverse slope .....	151-153	281
Riverline .....	154-156	286
Security forces .....	124-129	216
Surveillance and security .....	135	239
<b>Delaying actions:</b>		
Conduct .....	184	329
Organization of positions .....	182	326
Armored carriers, use .....	183	328
Terrain characteristics .....	181	325
Detachments left in contact .....	173	311
Direction of attack .....	50	71
Direct support .....	58	89
Dismount areas .....	85	147
Dispersion, defense .....	122	212
Echelon, platoon .....	app. V	411, 425
EENT .....	20	29
<b>Estimate of situation:</b>		
Steps in .....	app. II	387
Executive officer, duties .....	6	9
FEBA .....	123	215
Fire direction computers, duties .....	8	15
Fire planning .....	57	86
Fire support .....	57	86
Attachment .....	58	89
Direct support .....	58	89
General support .....	58	89
Reinforcing fires .....	58	89

	Paragraphs	Page
Fire team leader, duties.....	7	13
First sergeant, duties .....	6	9
Flank guard .....	38, 41	56, 59
Followup echelon .....	191	337
Food, supply .....	212	369
Formations, tactical .....	29	45
Forward observers:		
Artillery .....	57	86
Weapons platoon .....	8	15
General outpost line .....	125	217
General support .....	58	89
Infantry-tank team, methods of attack .....	76	136
Intelligence:		
Counterintelligence .....	23	34
Enemy information .....	22	33
Terrain .....	21	29
Weather .....	20	29
Limiting points .....	130	223
Line of departure .....	50, 60, 61	71, 93, 94
Line, platoon .....	app. V	411, 425
Main body .....	37	55
Maintenance and repair .....	221	379
Mechanized company .....	82-93	145
Medical service .....	220	378
Messenger, duties .....	6, 7	9, 13
METT .....	52	79
Mission, rifle company .....	2	6
Mortar squads:		
Displacement .....	74	125
FDC .....	74	125
Firing positions .....	74	125
Forward observers .....	74	125
Personnel, duties .....	8	15
Targets .....	74	125
Mounted attack, conduct .....	92	155
Mutual support .....	122	212



	Paragraphs	Page
Night attack:		
Characteristics .....	96	162
Conduct of attack .....	107	177
Control measures .....	99	165
Formations .....	100	169
Illumination .....	102	173
Orders .....	106	177
Security .....	101	172
Supporting fires .....	103	174
Techniques .....	96	162
Night movement .....	33	47
Objectives .....	50	71
Observation and fields of fire .....	21	29
Observation post .....	138, 142	243, 267
Offense, concept .....	44	65
Operation order .....	app. IV	396
Organic weapons, use .....	58	89
Personnel functions, company .....	209	364
Phase line .....	50	71
Platoon leader, duties .....	7, 8	13, 15
Platoon sergeant, duties .....	7, 8	13, 15
Point .....	35	50
Pursuit, mechanized .....	93	159
Radio net .....	26, 27	39, 42
Radiotelephone operators, weapons platoon .....	8	15
Raids:		
Conduct .....	119	208
Fire support .....	118	205
Organization .....	118	205
Planning .....	118	205
Rallying points .....	118	205
Rehearsals .....	118	205
Routes .....	118	205
Rallying points .....	118	205
Rear guard .....	39	59

	Paragraphs	Page
Reconnaissance and security		
line .....	127	221
Reinforcing fires .....	58	89
Relief in place:		
Command .....	165	299
Conduct .....	164	298
Planning .....	163	295
Reorganization .....	55, 63	85, 99
Reserve, employment .....	62	98
Reserve platoon:		
Defense .....	139	259
Offense .....	53	81
Reserved rifle company:		
Defense:		
Conduct .....	161	293
Counterattack		
planning .....	160	293
Missions .....	157	290
Positions .....	158	291
Security and		
surveillance .....	159	292
Offense .....	53, 94-95	81, 160
Retirement:		
Definition .....	169	305
Retrograde movements:		
Considerations .....	166, 167	300, 301
Reverse slope defense:		
Conduct .....	153	285
Fire support .....	152	282
Organization .....	152	282
When used .....	151	281
Rifle company:		
Capabilities .....	3	6
Characteristics .....	4	7
Organization .....	5, 9	8, 17
Rifle platoon:		
Attack order .....	69	109

	Paragraphs	Page
Rifle platoon—continued		
Conduct of attack:		
Assault .....	71	111
Assembly area to LD..	71	111
LD to assault line.....	71	111
Reorganization and consolidation .....	71	111
Fire support plan .....	68	106
Organization .....	5, 9	8, 17
Plan of maneuver .....	67	103
Preparation for attack .....	66	101
Squad leaders, actions.....	70	109
Rifle squad leader, duties .....	7	13
River crossing:		
Concept .....	109	182
Engineers, use .....	111	190
Planning .....	111	190
Rehearsal .....	111	190
Types .....	108	180
Use of armored carriers .....	110	184
Riverline, defense:		
Conduct .....	156	289
Fire support .....	155	287
Organization .....	155	287
Security and surveillance .....	155	287
Security .....	16, 54	27, 84
During movement .....	30	46
Rear installations .....	129	222
Security missions .....	32	47
Shifting fires .....	60	93
Standing operation procedure, company .....	15	24
Stay-behind force .....	170	305
Supply control point .....	13, 218	22, 376
Supply sergeant, duties .....	6	9
Switch position .....	123	215
Task force .....	113	198

	Paragraphs	Page
Troop leading procedure:		
Steps .....	app. III	391
Vee .....	app. V	411
Weapons platoon:		
Ammunition resupply ..	74	125
Attack, planning and conduct .....	74	125
Attack, preparation ..	73	123
In defense .....	140	262
Mission .....	72	122
Organization of .....	5, 9	8, 17
Weapons squad leader, duties .	7	13
Wedge .....	app. V	411, 425
Wire:		
Protective .....	133	233
Supplementary .....	133	233
Tactical .....	133	233
Wiremen, duties .....	6	9
Wire net .....	26, 27	39, 42
Withdrawal:		
By air:		
Concept .....	203	354
Conduct .....	207	357
Organization .....	206	357
Planning .....	204	355
Reconnaissance ..	205	356
Daylight:		
Conduct .....	179	321
Armored carriers, use	178	320
Planning .....	177	318
Definition .....	168	303
Night:		
Conduct .....	175	315
Detachments left in contact .....	173	311
Armored carriers, use .	174	314
Planning .....	172	309
Types .....	168	303
Zone of action .....	50	71

By Order of *Wilber M. Brucker*, Secretary of the Army:

**MAXWELL D. TAYLOR,**  
*General, United States Army,*  
*Chief of Staff.*

Official:

**R. V. LEE,**  
*Major General, United States Army,*  
*The Adjutant General.*

Distribution:

*Active Army:*

CNGB (1)	Inf Co (10)
Technical Stf, DA (1)	USATC (10)
Technical Stf Bd (1)	USMA (38)
USCONARC (15)	USAWC (5)
US ARADCOM (2)	USACGSC (1250)
US ARADCOM Rgn (2)	Br Svc Sch (5) except
OS Maj Com (10)	USAIS (5100),
OS Base Comd (5)	USAARMS (1700),
Log Comd (2)	USAAMS (2115), USAES (12), USA Ord Sch (600),
MDW (5)	USA QM Sch (10),
Armies (10)	USASCS (405),
Corps (2)	USATSCH (10)
Abn Div (5)	USAINTS (11)
Inf Div (5)	PMST Sr Div Units (2)
Brig (5)	PMST Jr Div Units (2)
Regt/Gp/Bg (2)	PMST Mil Sch Div Units (2)
except Abn Bg (5), Inf Bg (5)	Mil Dist (2)
Bn (2)	USA Corps (Res) (2)
	Sector, Comd, USA Corps (Res) (2)
	Mil Mis (2)

*NG*: State AG (3); units—same as Active Army except allowance is one copy to each unit.

*USAR*: Same as Active Army except allowance is one copy to each unit.

For explanation of abbreviations used, see AR 320-50.