

TC 10-19



**ALL-PURPOSE
LIGHTWEIGHT INDIVIDUAL
CARRYING EQUIPMENT
(ALICE)**

TC 10-19

21 July 1976

Changes in equipment will require changes or revision of the material presented. Field experience may also suggest changes. You are encouraged to send in recommended changes and comments. Be sure you key your comments to the exact page and line of text or illustration where you are recommending the change. Give reasons for each comment. Submit your comments on DA Form 2028 (Recommended Changes to Publications) or by letter to:

Commandant
US Army Quartermaster School
ATTN: ATSM-TD-TL
Fort Lee, Virginia 23801.

ALL-PURPOSE LIGHTWEIGHT INDIVIDUAL CARRYING EQUIPMENT

(ALICE)

The all-purpose lightweight individual carrying equipment (ALICE) is made up of components for the fighting load and additional components for the existence load.

You can use these components in all environments — hot, temperate, cold-wet regions, and even in cold-dry arctic regions.



TC 10-19

PREFACE

The M-1956 lightweight load-carrying equipment has been replaced as the standard item by the all-purpose lightweight individual carrying equipment (ALICE). You must follow certain rules if the new load-carrying equipment is to do the job for which it is intended. If you follow the rules listed below, you will be able to carry loads with much more ease and comfort.

■ *If you do not follow the rules, you will make a hard job that much harder.*

AND REMEMBER — —
IT'S YOUR BACK!

Here are the simple rules....

- Keep your load as light as possible.
- Know your equipment.
- Assemble the equipment properly.
- Keep every item in its proper place.

TABLE OF CONTENTS

FIGHTING LOAD COMPONENTS

Equipment 4

Assembly 7

EXISTENCE LOAD COMPONENTS

Equipment 16

Assembly 22

MAINTENANCE INSTRUCTIONS

..... 36

In the Army of the Potomac [during the Civil War] there were two species of marching employed—in “LIGHT MARCHING—ORDER”, and in “HEAVY MARCHING—ORDER”.

The former meant that the troops were to carry all they possessed with them; the other was to march with only the musket, ammunition, haversack, and canteen, thus being in trim for working or fighting. Every order to march specified one or the other manner.

Joel Cook ---
The Siege of Richmond

FIGHTING LOAD COMPONENTS

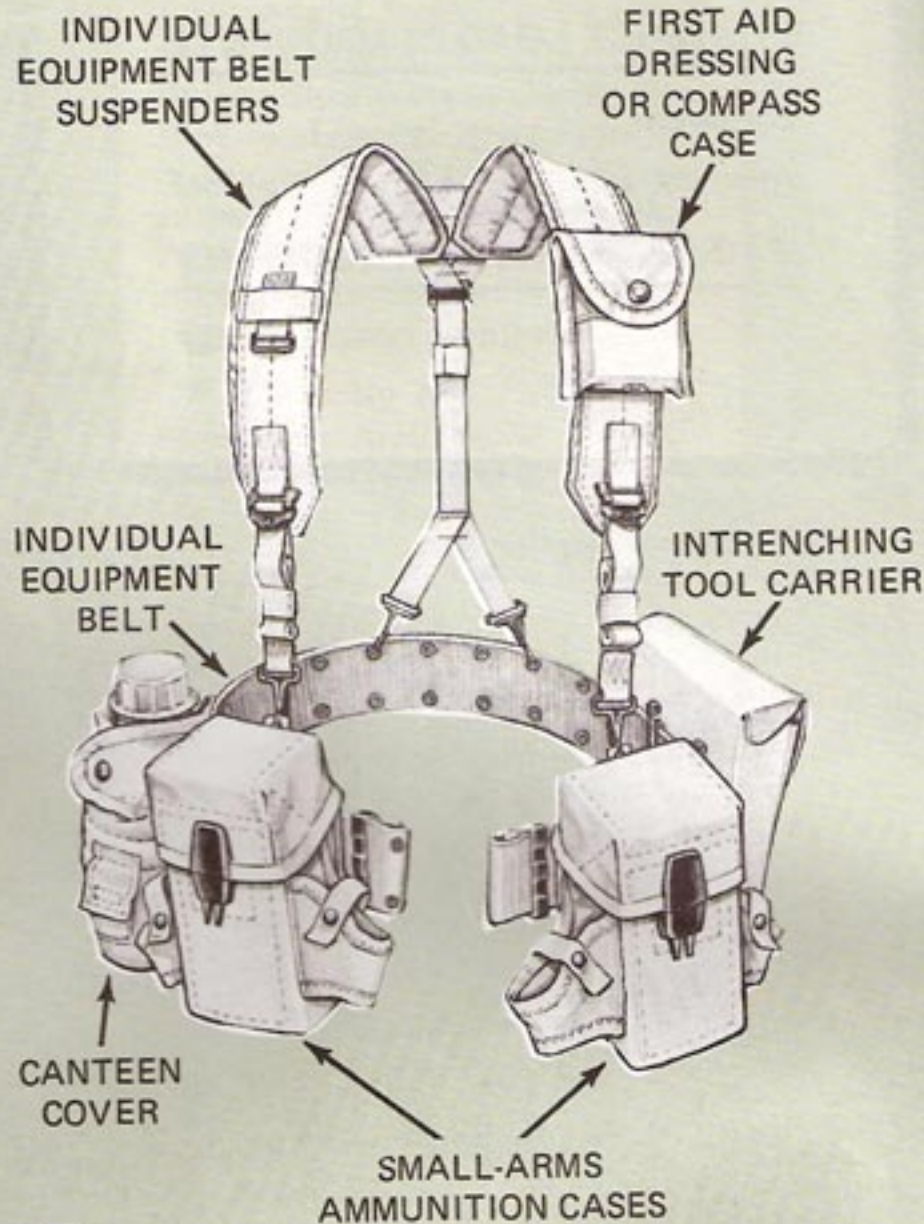

INDIVIDUAL EQUIPMENT BELT

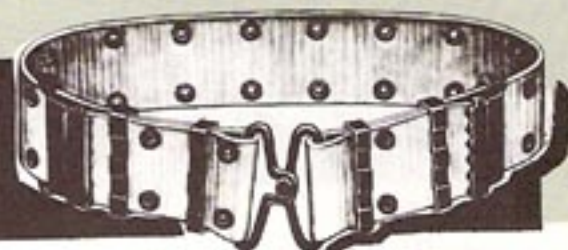

Use. Use the individual equipment belt to carry the ammunition cases, intrenching tool carrier, and the canteen cover.

Fitting. The belt is issued in medium and large sizes so that it can be adjusted to fit over all layers of outer clothing, including the complete cold-dry ensemble and the armor vest. If your bare waist measures less than 30 inches, wear the medium size. If your bare waist measures 30 inches or more, wear the large size.

INDIVIDUAL EQUIPMENT BELT SUSPENDERS

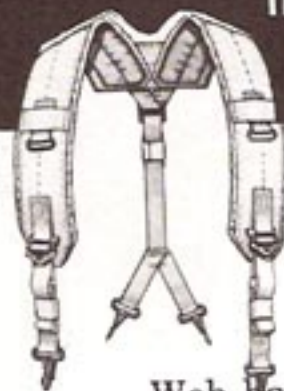

Use. Use the belt suspenders to support the individual equipment belt when the appropriate components are attached to the belt. Web band metal loops are provided on each suspender strap for attachment of small items such as the first aid/compass case or a flashlight.

Fitting. The suspenders are issued in one size only and are adjustable.

SMALL-ARMS AMMUNITION CASES

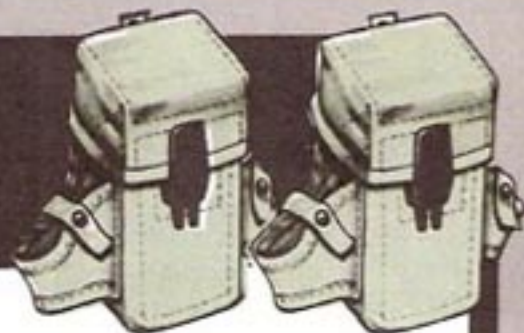

Each of the two small-arms ammunition cases holds three 30-round magazines (M-16 rifle). The cases have fragmentation grenade pockets on each side and a plastic fastener that can be opened and closed with one hand.

INTRENCHING TOOL CARRIER



Use the plastic intrenching tool carrier to carry the lightweight, collapsible intrenching tool.

CANTEEN COVER

Use the canteen cover to carry the plastic water canteen and metal cup. The cover has a small pocket attached for carrying water purification tablets.



FIRST AID DRESSING/COMPASS CASE

Use the case to carry either a first aid dressing or an unmounted magnetic compass.



6

ASSEMBLY OF FIGHTING LOAD COMPONENTS

The procedure for assembling the fighting load components of the all-purpose lightweight individual carrying equipment (ALICE) is described below.

NOTE:

A different procedure must be followed when the equipment is assembled by parachutists when preparing for a jump. The parachutist's procedure is described in TM 57-220.



Fit and Adjust the Belt

Try on the individual equipment belt and determine the length needed to have it fit snug -- not tight. Then, and at each end of the belt, proceed as follows:

7

- Slide the two metal keepers away from the belt buckle and the adjusting clamp.

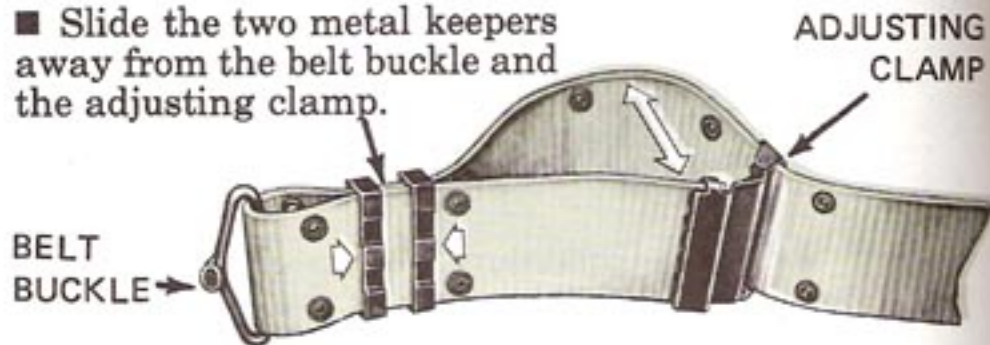

- Unlock the adjusting clamp by spreading apart the looped webbing.

- Slide the adjusting clamp toward the belt buckle to loosen the belt and away from the belt buckle to tighten it.

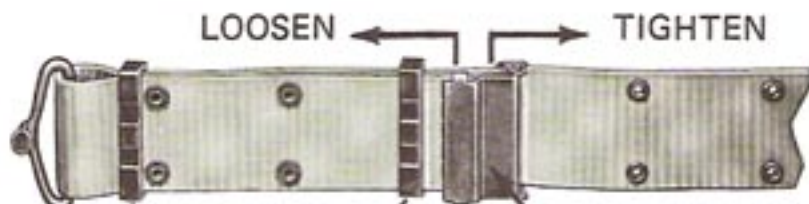

- Squeeze the adjusting clamp to lock the belt in place; then

slide the metal keepers so that one is next to the adjusting clamp and the other is next to the belt buckle. Each adjusting clamp should be about the same distance from the belt buckle.



- Buckle and place the belt as shown.

8

2

Attach the Ammunition Cases to the Belt

Attach one ammunition case to the left side of the belt next to the belt buckle and the other ammunition case to the right side of the belt next to the buckle. To do this, proceed as follows:

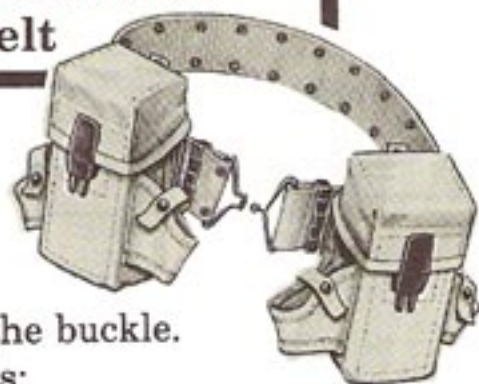

- Pull each slide keeper attached to the case to an open position and slide it over one thickness of the webbing. Make sure the slide keepers are vertical and the bottom holes are out beyond the webbing.

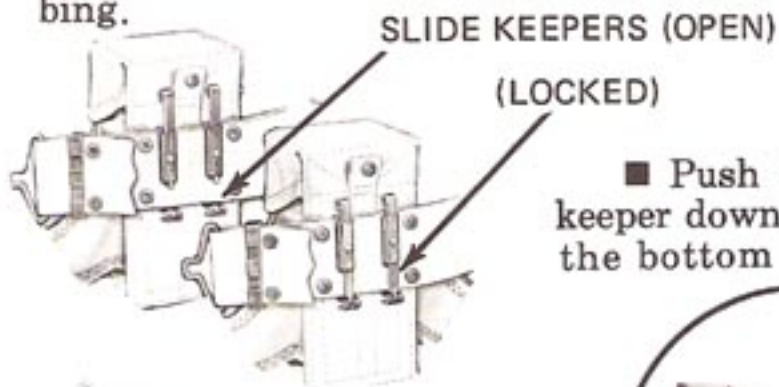

- Push the slide keeper down and into the bottom holes.

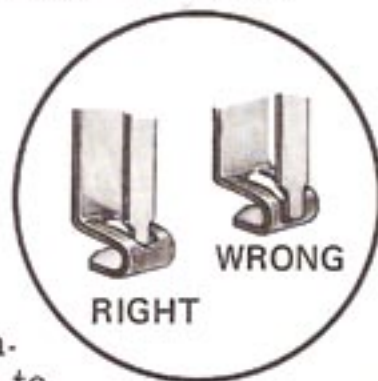

NOTE: When attaching 20-round cases, attach the front suspender snap hooks to the top eyelet nearest the buckle on each end of the belt. Fasten the snap hook on the end of each ammunition case supporting strap to the metal loop on the front of each shoulder strap.



9

3**Attach the Suspenders to the Belt and Ammunition Cases.**

To attach the suspenders to the belt and ammunition cases, proceed as follows:

■ Open all suspender snap hooks by pushing the hooks up and out of the retainers.

■ Attach the back suspender snap hooks into the eyelet at each side of the two center top eyelets at the back of the equipment belt. Close the snap hooks.

■ Attach the front suspender snap hooks to the eyelets on the back of the ammunition cases. Close the snap hooks.

■ When the ammunition cases are not used, attach the front suspender snap hooks to the top eyelet on the side of each belt buckle and close the snap hooks.

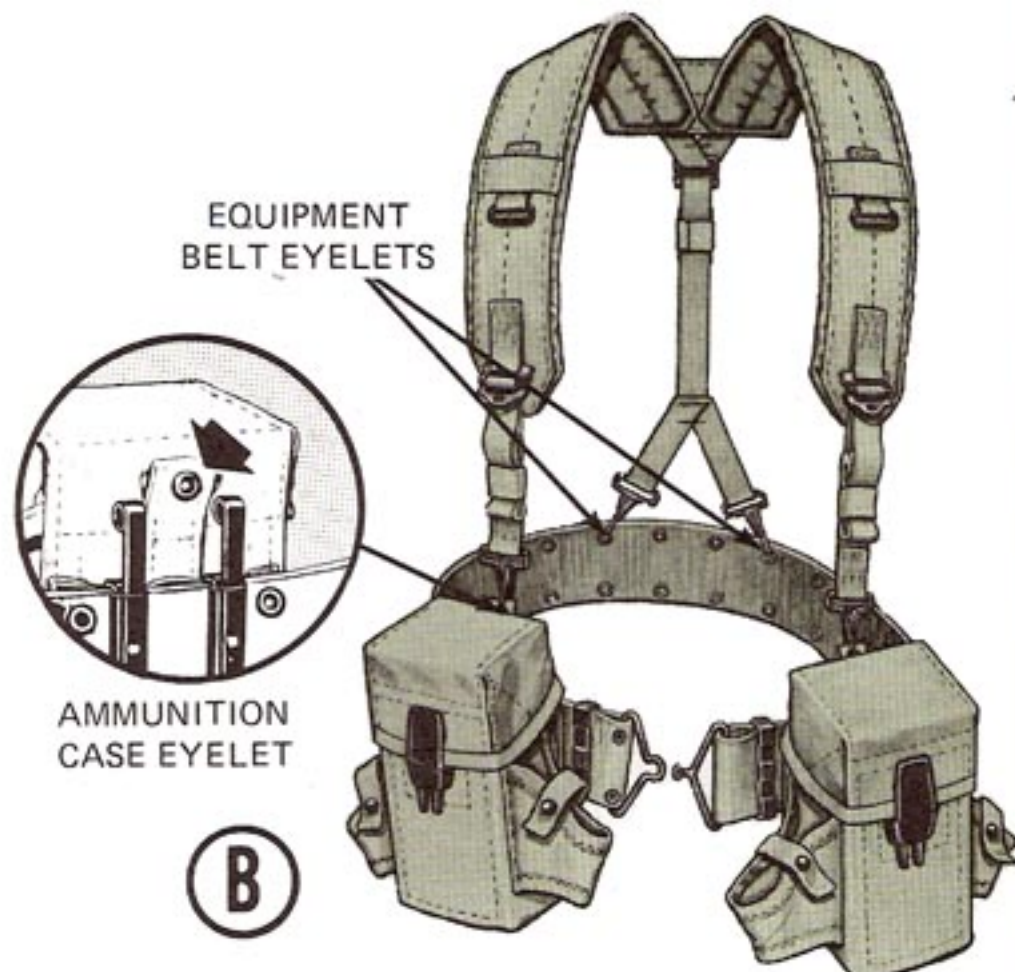
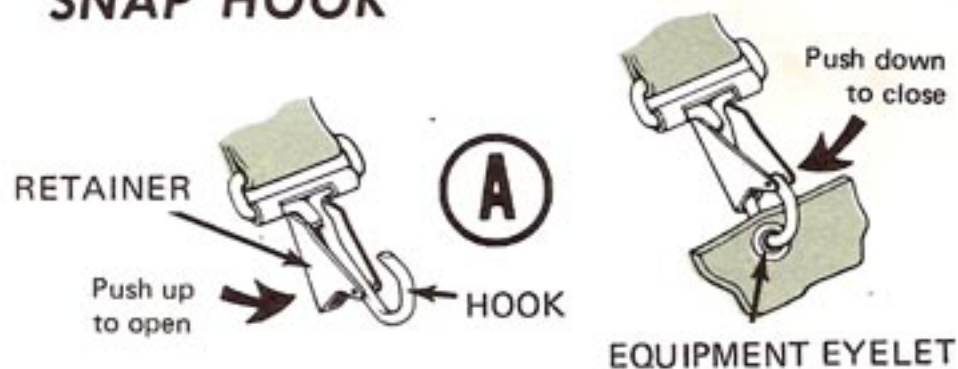
A**B****SNAP HOOK**

Attaching suspenders to belt and ammunition cases.

4**Attach the Intrenching Tool Carrier**

Using the two slide keepers on the back of the carrier, attach the carrier to the belt on the left side as close as possible to the ammunition case. Place the intrenching tool in the carrier so that the blade portion is to the back of the carrier.

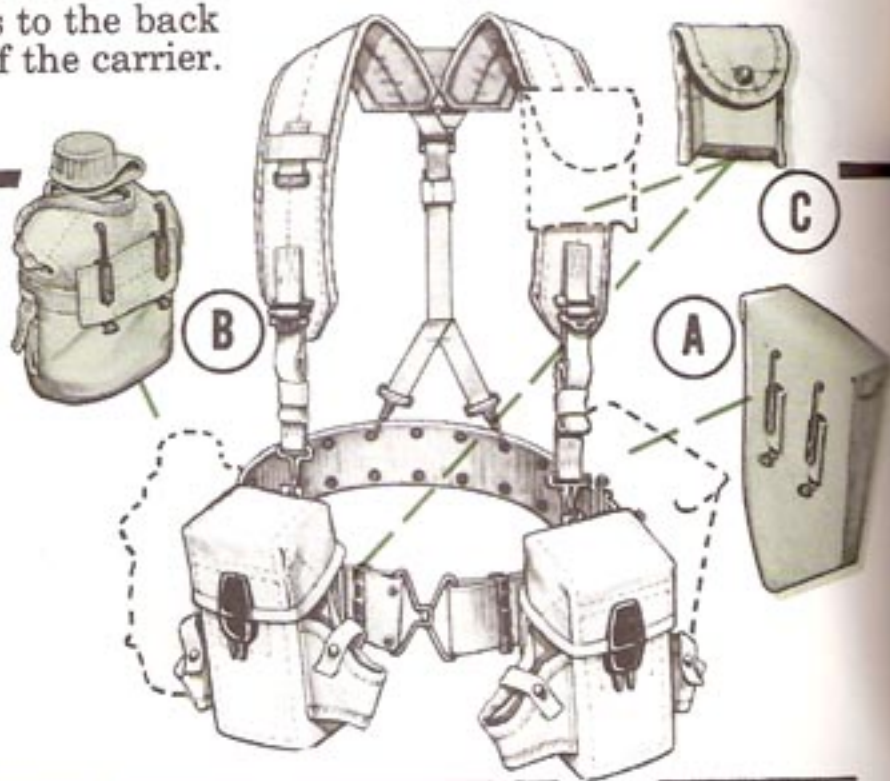
**5****Attach the Canteen Cover**

Using the two slide keepers on the back of the canteen cover, attach the cover on the right side as close as possible to the ammunition case.

12

6**Attach the First Aid Dressing/Compass Case**

Using the slide keeper on the back of the case, attach the case in either of the following places:

- To the webbing loop on the front of either shoulder strap.
- On the right side of the belt next to the ammunition case (preferred position).

13

7

Adjust the Front and Back Suspender Straps.

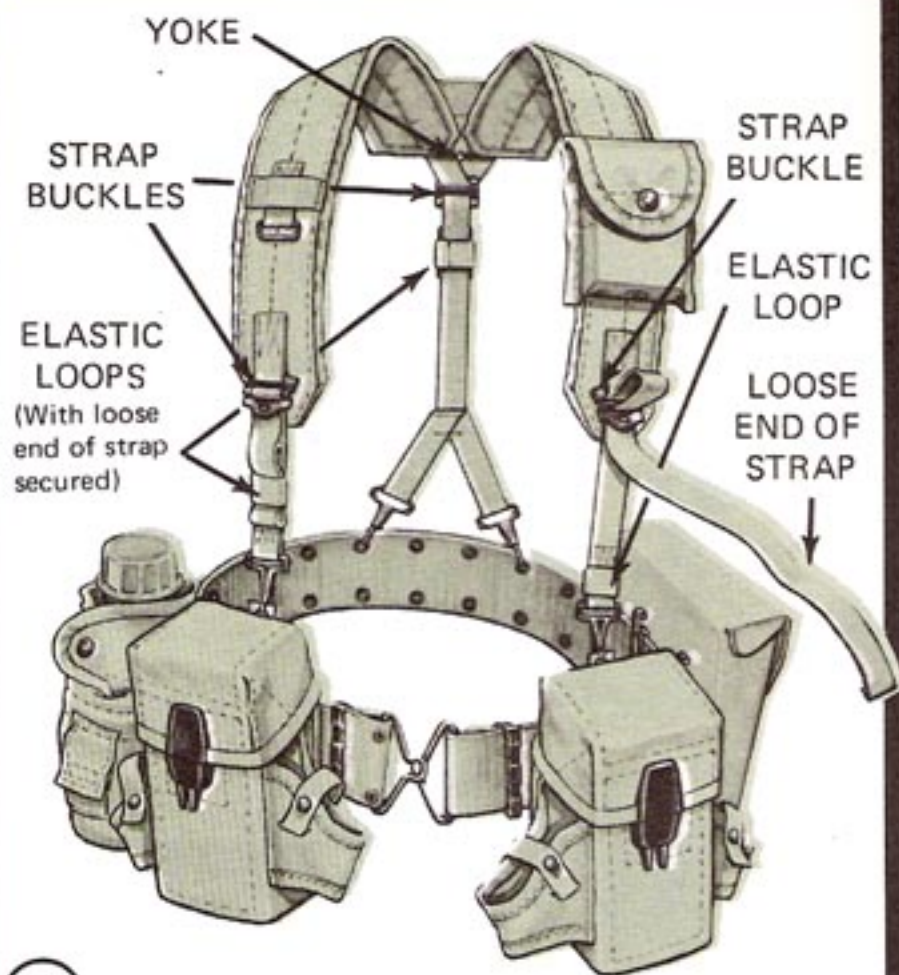

1 After you have the equipment attached to the belt and suspenders, put it on and fasten the buckle.

2 Adjust the length of the front and back suspender straps so that the belt hangs evenly at your waist and the yoke is positioned comfortably. To do this, proceed as follows:

- Pull down on the loose end of each strap to tighten (raise the belt) or lift the end of each strap buckle to loosen (lower the belt).
- Secure the loose ends of the straps with the elastic loops.

NOTE: Although you can adjust the back suspender strap yourself, you can do it easier by using the buddy system.

EXISTENCE LOAD COMPONENTS



GROUND TROOPS PACK FRAME (A)

Use the ground troops pack frame as a mount for either the medium combat field pack or the large combat field pack. You may use the pack frame either with or without the cargo support shelf

PACK FRAME STRAPS (B)

Straps attached to the pack frame consist of a lower back strap, waist straps, and two shoulder straps. A quick release device is attached to one of the shoulder straps and to one of the waist straps.

CARGO SUPPORT SHELF (C)

Use the cargo support shelf to support bulky loads such as water, gasoline, and ammunition cans; field rations; and radio.

CARGO TIEDOWN STRAPS (D)

Use the two cargo tiedown straps to secure equipment to the pack frame.



MEDIUM COMBAT FIELD PACK

Use the medium combat field pack to carry existence loads including clothing, rations, and personal items. The pack has a pouch with a drawcord closure, and three outside smaller pockets. These pockets are tunneled to the pouch so that long objects can be carried between the pouch and each pocket. The pouch also has a special inside pocket to carry the AN/PRC 25 or 77 radio, if necessary. The pouch flap

has a pocket that can be opened by pulling two tabs apart. Small flat items can be carried in this pocket. Pressing the flap sides together closes it. Hangers are also provided to carry individual equipment or extra ammunition.

If the pack is not to be filled to capacity, before placing objects in the pack, shorten the pack using the tiedown cords and "D" rings inside the pouch.

The pack is usually carried directly on your back by transferring the shoulder straps from the pack frame to the pack, although you may carry it by attaching it directly to the pack frame.

When you wear the medium pack in extreme cold climates, you must wear it on the frame.

The pack is water repellent, but not waterproof. Four waterproof liners are issued with each pack; one large one for the pouch and three smaller ones for the three outside pockets. Put equipment or items to be carried in the waterproof liners and then place them in the pouch or pockets.

NOTE: *Waterproof liners were included only with the initial issue of ALICE equipment. Later issues do not have these liners.*

LARGE COMBAT FIELD PACK



Use the large combat field pack to carry excessively large loads - usually for special missions or in the arctic regions.

It is much the same as the medium combat field pack except that it is larger, and there are three more small pockets at the top of the pouch. Of the three lower outside pockets, the two outer ones are tunneled to the pouch so that long objects can be carried between the pouch and each pocket. As with the medium pack, tiedown cords and "D" rings inside the pouch can be used to shorten the pack if it is not to be filled to capacity.

● Always carry the large combat field pack on the pack frame.

FIELD PACK CAMOUFLAGE COVER

Use the white camouflage field pack cover to camouflage the olive green color of the field pack when operating in snow covered terrain.

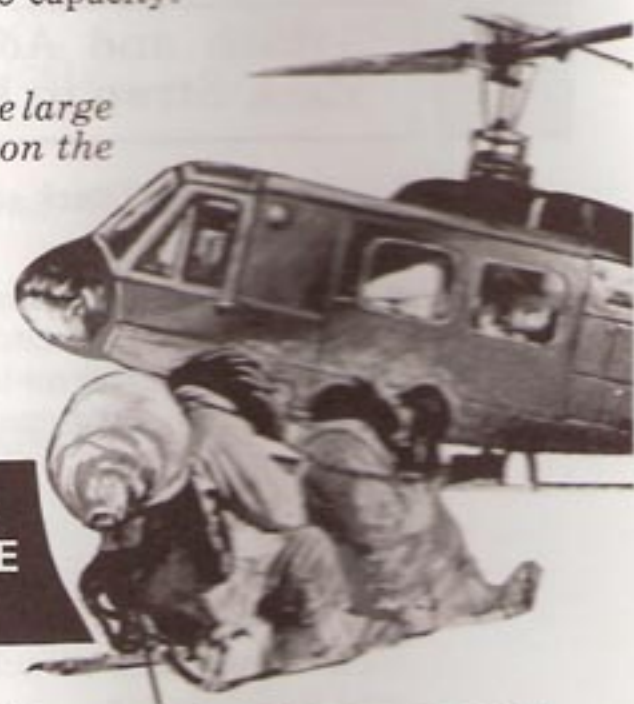

ASSEMBLY OF EXISTENCE LOAD COMPONENTS

Procedures for assembling the existence load components are described below. Certain components, such as the pack frame strap, may be issued already assembled.

Refer to TM 57-220 for parachutist's procedures.

1 Attach and Adjust Lower Back Strap to Pack Frame

- To Attach lower back strap, proceed as follows:
 - With padded surface outward, insert each end of the strap through the metal loops on the bottom crossmember of the pack frame.
 - Attach the turnbuckle to the two ends of the strap.
 - Tighten the turnbuckle and lock it with the attached nut and lock washer.

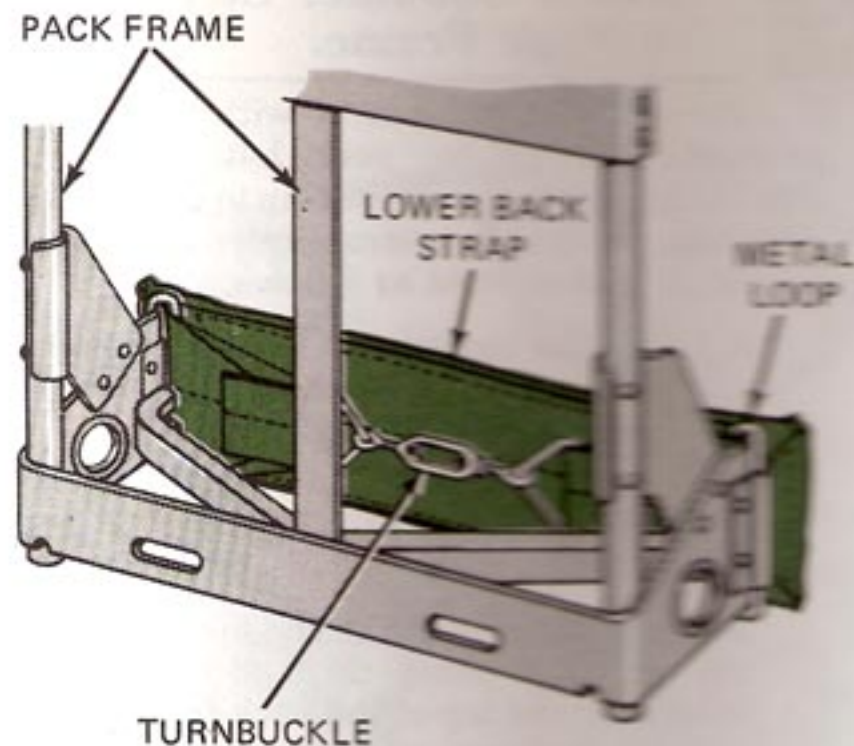

- Adjust lower back strap.

The lower back strap keeps the load away from your back and lets air circulate between your back and the load.

It is adjusted with the turnbuckle.

Tightening the turnbuckle causes the strap to be flat. If your waist is small, loosen the turnbuckle enough to allow the strap to curve in and fit against the lower part of your back.

2**Attach Shoulder Straps to Pack Frame.**

Attach the shoulder strap with the quick release assembly to your left shoulder. Attach the other shoulder strap to your right shoulder. To attach a strap, refer to figure, opposite, and proceed as follows:

- Insert the looped end, from the inside of the frame, through the plastic grommet to the outside of the frame.
- Pass the other end of the shoulder strap through the loop and pull tight (inset C).
- Insert the webbing of the loose end of the shoulder strap through the metal keeper on the top of the pack frame (inset A), making sure the padded side of the shoulder strap is facing inward.
- Thread the webbing through the nonslip buckle and tighten.

Attach Waist Straps to Pack Frame.**3**

Attach the waist strap with the quick release pull tab to either the left or right of the frame depending on which hand you use to pull the tab for quick release. Attach the other strap to the opposite side. To attach the waist strap, insert the looped end around the lower part of the frame, insert the other end through the looped end, and pull tight (inset B).

24

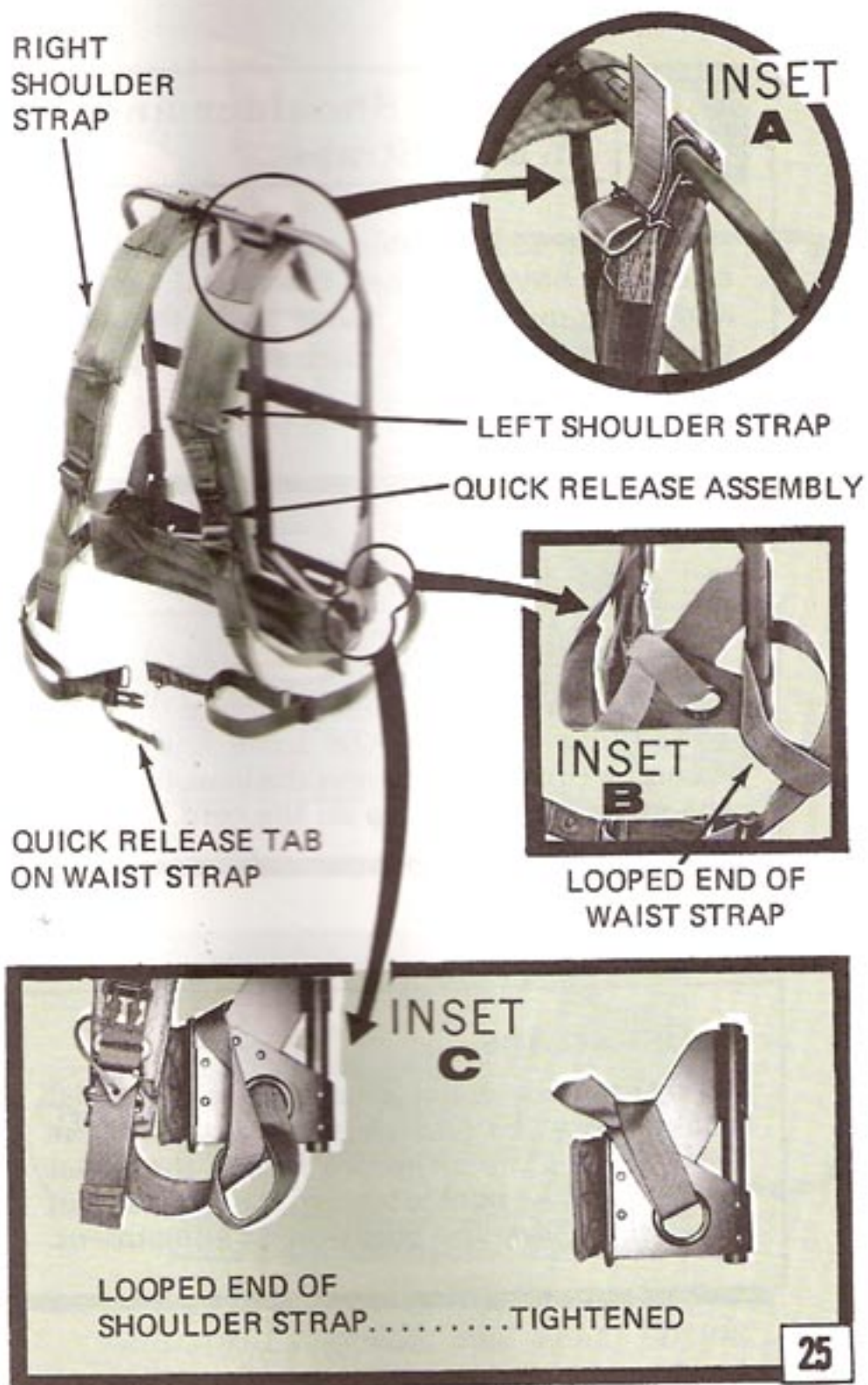

25

4

Adjust Shoulder and Waist Straps

Adjust the shoulder and waist straps after you have attached them to the frame and have put on the frame with the load you are going to carry. Each set of straps has adjustment buckles.

Shoulder straps

To lift the load on your back, shorten the strap by pulling down on the loose end of the webbing (inset A). To lower the load, lengthen the strap by pulling up on the cord.

Waist straps

To tighten the waist straps, open the waist buckle (inset B) and slide it away from the front end of the strap. To loosen the waist strap, slide the buckle toward the front end of the strap. Close the buckle after adjustment.



Adjusting shoulder and waist straps.

5**Attach Medium Combat Field Pack to Pack Frame**

To attach the medium pack to the pack frame, proceed as follows:

- Insert the bare frame into the envelope on the back of the pack.



- Loop the strap located on the bottom of the pack around the frame twice (inset).
- Buckle the end of the strap to the nonslip buckle.
- Attach and adjust the shoulder straps and waist straps as previously described.

28**6****Attach Shoulder Straps to Medium Combat Field Pack**

The medium field pack may be carried using the shoulder straps without the pack frame. Attach the shoulder strap with the quick release at your left shoulder.



To attach a shoulder strap to the pack, insert the looped end through the "D" ring on the bottom of the pack, pass the other end of the shoulder strap through the loop and pull tight. Next, insert the webbing of the loose end of the shoulder strap through the metal loop at the top of the pack (inset), making sure the padded side of the shoulder strap is facing inward. Then thread the webbing through the nonslip buckle (inset) and tighten. Adjust the shoulder straps as previously described. **WARNING:** When you carry the medium combat field pack in extreme cold climates, you must wear it on the pack frame. Using the pack frame will prevent accumulation of sweat in the area where the pack contacts your back; this moisture can cause you to cool rapidly.

29

7

Attach Large Combat Field Pack to Pack Frame

Use the same procedures to attach the large combat field pack to the pack frame as those used to attach the medium combat field pack.

8

Attach Cargo Shelf and Cargo to Pack Frame

Cargo shelf. Attach the cargo shelf to the pack frame by hooking it onto either the middle or bottom brace of the frame as shown.

CARGO SHELF
ATTACHED TO
MIDDLE BRACE

POSITION
OF CARGO SHELF
WHEN ATTACHED
TO BOTTOM BRACE



30

Cargo. Use the cargo tiedown straps to secure a load such as a 5-gallon can, ammunition case, field ration case, or radio to the pack frame.

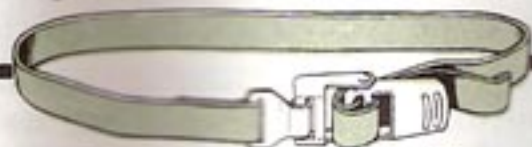

■ Wrap the tiedown strap around the load and the frame as shown.

■ Place the flat hook end of the tiedown strap into the slot at the buckle as shown, and pull the loose end to tighten, leaving a little slack in the strap.



■ Then push the fastener into the closed position as shown above. This takes up the slack and tightens the strap around the cargo.

CAUTION:

Leave enough slack in the strap so that when you close the fastener, the strap will not fit too tightly around the cargo so as to crush it.

■ Pull up on the end of the strap to open the fastener and loosen the strap.

31

COMBAT FIELD PACK CLOSURES

After either the medium or large combat field pack is loaded, close the pockets and pouch as follows:

Inside (Radio) Pocket. Thread the webbing through the nonslip buckle and pull to tighten and close the pocket.

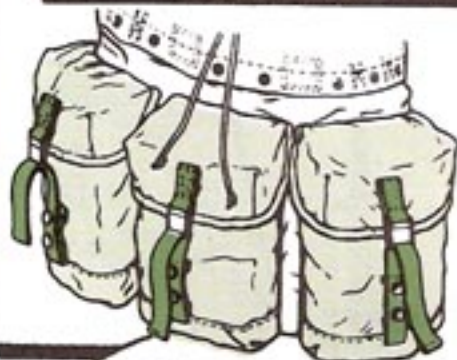
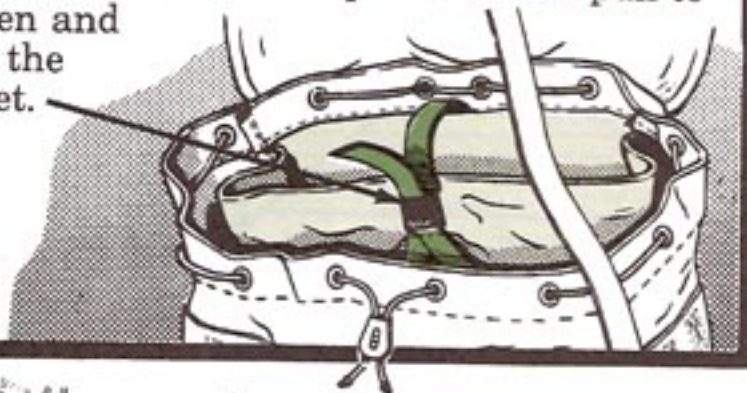

Three Outside Pockets. Make sure the two snap fasteners at one end of the webbing are fastened, then pull the webbing to tighten and close the pocket. You can open the pocket easily by pulling the tab to unsnap the snap fasteners. You can also close the pocket by resnapping the snap fasteners.

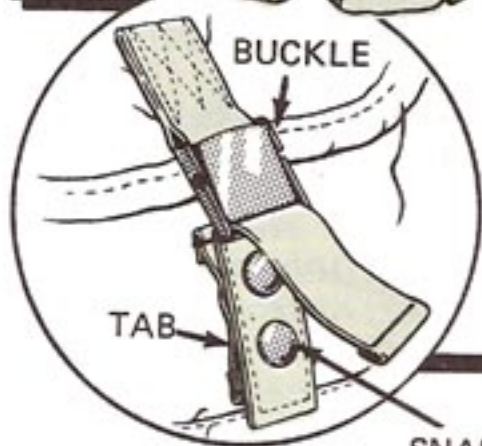

SNAP FASTENERS

32

Pouch. Pull the two drawstring cord clamp ends outward. This will gather the top into a tight closure.

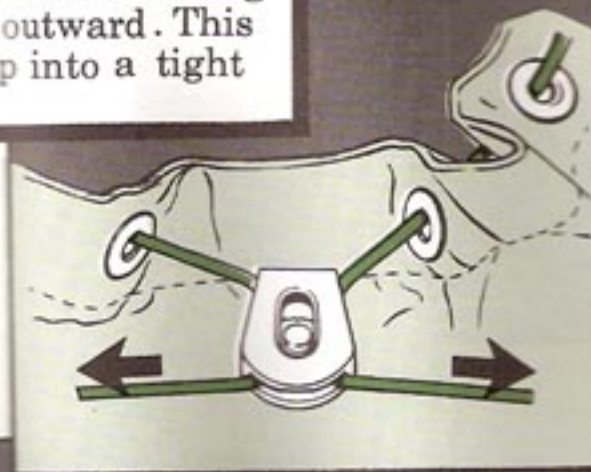

To loosen the drawstring, push the button on the drawstring buckle down and, at the same time, pull the clamp down

Combat field pack closures.

33

Pouch Flap

Insert the pouch flap tiedown strap through the web loop on top of the pouch flap, down over the pouch flap



. and into the bottom nonslip buckle. Pull tight.

Combat field pack closures (Continued).

QUICK RELEASES

Your back pack, with or without the pack frame, can be removed quickly by using the quick releases on the left shoulder strap and the waist strap.

The quick release device consists of

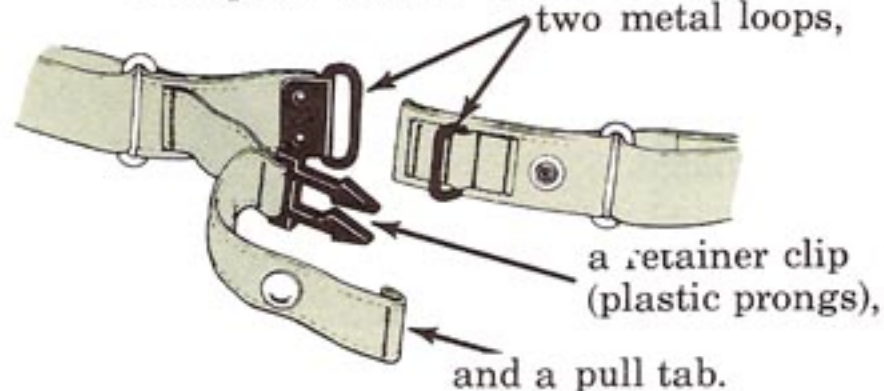

Assembly. To assemble the quick release device, place the large metal loop over the small metal loop.

Then insert the retainer clip (prongs) through the larger metal loop.

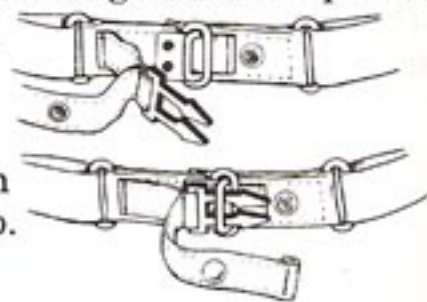

On the waist strap, fasten the snap fastener on the pull tab to protect the quick release device

Release. To remove the load quickly, firmly pull the tab on the waist strap.



Then immediately pull up on the tab on the shoulder strap. Shift the load to your right and let it slip off your right shoulder.

MAINTENANCE INSTRUCTIONS

To clean the equipment, remove dirt or mud with a cloth or soft brush. Then dip the item vigorously in a pail of warm water containing soap or detergent. If soiled spots remain, scrub the spots with a white or colorfast cloth and dip again. Rinse the item thoroughly and stretch it back to its original shape while it dries. Dry it in the shade or indoors – never in direct sunlight.

● Don't use chlorine bleach, yellow issue soap, cleaning fluid, or dye.

● Don't launder or dry in commercial or home-type automatic laundry equipment.

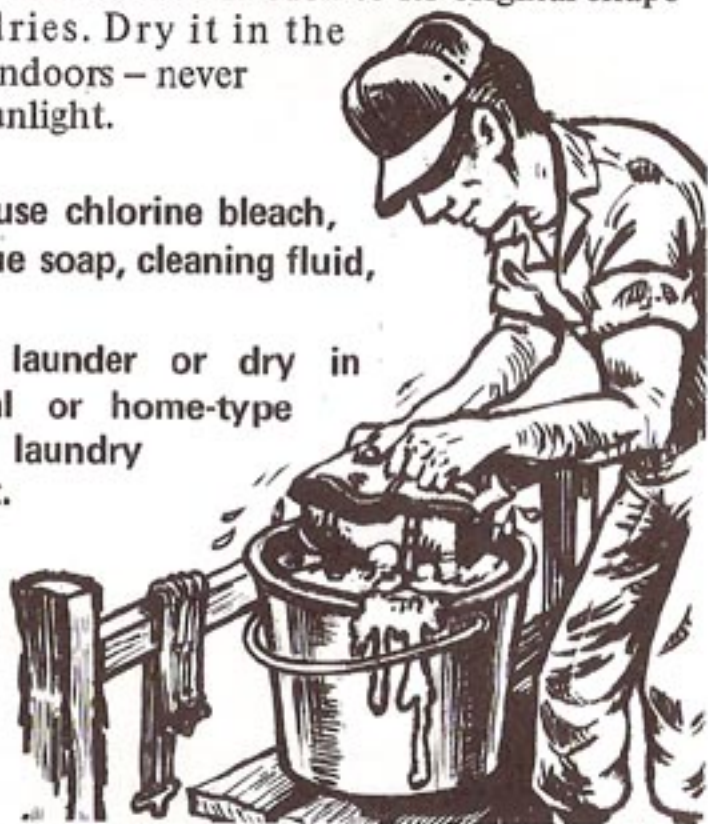

Limit your "field expedient" repair to hand sewing or taping damaged or loose stitching, and replacing slide keepers. Maintenance above the user level should be in accordance with TM 10-8400-201-23, General Repair Procedures for Clothing and Individual Equipment.

TAKE THE TIME---

We really want to know what you think of this manual. So if you'll take the time to fill out this questionnaire, We'll take the time to read it and act on it. Thanks!

TC 10-19
21 July 1976

By Order of the Secretary of the Army:

FRED C. WEYAND
General, United States Army
Chief of Staff

Official:

PAUL T. SMITH
Major General, United States Army
The Adjutant General

DISTRIBUTION:

Active Army, USAR, and ARNG: To be distributed in accordance with DA Form 12-11A, Requirements for Care and Use of Individual Clothing and Equipment (Qty rqr block no. 163), and DA Form 12-12, Section V, Requirements for training publications applicable to Basic USATC (Qty rqr block no. 1355).