

ARMY REGULATIONS
No. 600-40
(w/ Changes 1-7 incl.)

WAR DEPARTMENT,
WASHINGTON 25, D. C., 31 March 1944
(11 August 1944—31 October 1945)

PERSONNEL

WEARING OF THE SERVICE UNIFORM

	Paragraphs
SECTION I. Occasions _____	1-13
II. Various classes of personnel _____	14-30
III. Various articles of clothing _____	31-47
IV. Insignia _____	48-67
V. Decorations, service medals, etc _____	68-75
VI. Various articles of equipment _____	76-79
VII. Miscellaneous _____	80-84

SECTION I

OCCASIONS

	Paragraph
Uniform to be worn _____	1
Service uniform _____	2
Officers to be in same uniform as troops _____	3
Funerals; mourning _____	4
Duty as aide to President; as aide at White House _____	5
In foreign countries _____	6
Uniform to be worn outside posts, camps, and stations _____	7
Service uniform, arms, and equipment for officers _____	8
Service uniform, arms, and equipment for enlisted men, except aviation cadets _____	9
Service uniform, arms, and equipment for aviation cadets _____	10
Work uniform for officers, warrant officers, flight officers, and enlisted men _____	11
White uniform for enlisted men _____	12
Oilskin clothing _____	13

1. Uniform to be worn; exceptions. --a. The prescribed or authorized uniform will be worn by officers, warrant officers, flight officers, and enlisted men at all times, whether on or off duty, when attending ceremonies and social functions of an official nature, and when in foreign countries. Exception is authorized when engaged in games or sports, for which clothing appropriate to the game or sport may be worn, or when at home with not exceeding two guests. Officers granted terminal leave pending return to an inactive status may at their option wear civilian clothes during the period of leave.

1. Uniform to be worn; exceptions. --a. The prescribed or authorized uniform will be worn by all **military personnel in an active duty status** at all times, **except as provided in this paragraph and in paragraph 6.** Exception is authorized when engaged in games or sports, for which clothing appropriate to the game or sport may be worn, or when at home with not exceeding two guests. Officers granted terminal leave pending return to an inactive status may at their option wear civilian **clothing** during the period of leave. [AG 421 (4 Sep 44)]

1. Uniform to be worn; exceptions. --a. The prescribed or authorized uniform will be worn by all military personnel in an active duty status at all times, except as provided in this paragraph and in paragraph 6. Exception is authorized when engaged in games or sports, for which clothing appropriate to the game or sport may be worn, or when at home with not exceeding two guests. **Military personnel on terminal leave or retirement furlough** may at their option wear civilian clothing during the period of leave. [AG 421 (4 Apr 45)]

b. All articles of uniform for wear by the General of the Armies, the Chief of Staff, and a former Chief of Staff are such as each may prescribe for himself.

*This pamphlet supersedes AR 600-40, 28 August 1941, including C 1, 14 August 1942; C 2, 25 August 1942; C 3, 29 August 1942; C 4, 5 September 1942; C 5, 19 September 1942; C 6, 28 September 1942; C 7, 23 October 1942; C 9, 26 November 1942; C 10, 29 December 1942; C 11, 21 January 1943; C 12, 6 March 1943; C 16, 39 April 1943; C 17, 12 May 1943; C 18, 15 May 1943; C 21, 17 June 1943; C 22, 19 June 1943; C 23, 25 June 1943; C 24, 5 July 1943; C 25, 8 July 1943; C 26 9 July 1943; C 27, 12 July 1943; C 28, 20 July 1943; C 29, 10 August 1943; C 30, 19 September 1943; section I, Circular No. 223, section I, circular No. 258, War Department, 1941; section I, Circular No. 28; section I, Circular No. 50; section III, Circular No. 207; section III, Circular No. 403, War Department, 1942; section II, Circular No. 111; section I, Circular No. 224, and section I, Circular No. 210, War Department, 1943.

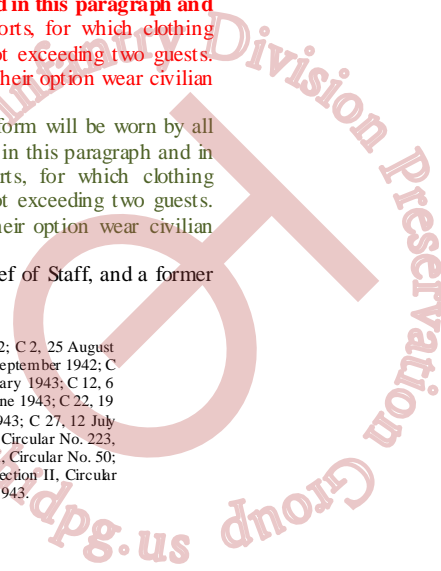

c. Whenever changes in design or material of uniforms are prescribed in War Department Directives, all members of the Army are authorized to wear out existing clothing. Uniforms procured or manufactured after promulgation of the changes will be of the new type.

2. Service uniform. --The uniform for ordinary wear as prescribed is the service uniform, of which there are two kinds, the winter and the summer. The winter uniform will be prescribed by the commanding officer for habitual wear when the climate or weather does not require the summer uniform. The summer uniform will be prescribed by the commanding officer for wear when the climate or weather requires it.

3. Officers to be in same uniform as troops. --Officers on duty with or attached in any capacity to troops will wear the corresponding uniform prescribed for officers with the following exceptions:

a. Officers may wear the winter uniform when the troops are in summer uniform, or vice versa.

b. Inspectors will wear such uniform as is considered best adapted to the performance of their duty.

4. Funerals; mourning. --a. *Funerals.* --For military funerals, the service uniform will be worn.

b. *Mourning.* --The badge of military mourning will consist of a straight band of black crepe or plain black cloth 4 inches wide, worn around the left sleeve of the outer garment above the elbow. It will be worn only when prescribed by the commanding officer for funerals, or when specially ordered by the War Department. As family mourning, officers may wear the sleeve band prescribed herein.

5. Duty as aide to President; as aide at White House. --Officers regularly detailed as aides to the President, or as junior aides for duty at the White House, will, while in the performance of duty as such, wear such uniform as may be especially prescribed by the War Department.

6. In foreign countries. --a. The uniform will be worn as may be prescribed by the laws or regulations of foreign countries by officers of the Army, active or retired, stationed in or visiting such countries in an official capacity.

6. In foreign countries. --a. Except as provided below, all military personnel in an active duty status, present in foreign countries in any capacity, will wear the uniform as prescribed in paragraph 1.

(1) The uniform will not be worn in a neutral country unless prescribed by the military attaché present therein, or by an appropriate United States military authority. On flights in commercial aircraft through neutral countries, military personnel may not wear uniforms nor may they openly carry military equipment.

(2) The uniform will be worn by all military personnel in an active duty status when present in a belligerent or friendly foreign country, unless otherwise prescribed by the War Department.

(3) The military attaché stationed in a foreign country may prescribe other clothing for personnel assigned or attached to his staff.

b. The uniform will not be worn by members of the Army, active or retired, visiting or residing in a foreign country in an unofficial capacity except when attending, by formal invitation, ceremonies or social functions at which the wearing of the uniform is required by the terms of the invitation or by the regulations or customs of the country.

b. The uniform will not be worn by **military personnel in an inactive duty status** in a foreign country in an unofficial capacity except when attending, by formal invitation, ceremonies or social functions at which the wearing of the uniform is required by the terms of the invitation or by the regulations or customs of the country. [AG 421 (4 Sep 44)]

7. Uniform to be worn outside posts, camps, and stations. --a. The commanding general of each service command and of the Military District of Washington will designate the prescribed or authorized uniform to be worn within the command by all military personnel outside the limits of posts, camps, and station, except when such personnel are performing an assigned duty or in maneuver areas in which the uniform to be worn is prescribed by the unit commander of the unit involved.

8. Service uniform, arms, and equipment for officers. --a. For habitual wear when not in formation under arms, except as otherwise prescribed in these regulations.

(1) *By whom worn.* --All officers, warrant officers, and flight officers.

(2) *Articles.*

(a) *When dismounted.*

1. Cap, service, except when other headgear is prescribed or authorized (par. 36).

2. Coat, service, except when shirt without coat is authorized (par. 33).

3. Decorations, service medals, and badges as prescribed or authorized (pars. 68, 69, and 70).

4. Gloves (par. 35).

5. Necktie (par. 39).

6. Ribbons, service, optional (par. 73).

7. Shirt (par. 40).

8. Shoes, Army russet leather, except when boots are authorized (par. 34).

9. Socks, plain tan (or brown) when low shoes are worn (par. 34).

10. Trousers, service (par. 43), except when breeches are authorized (par. 32).

11. Tags, identification.

12. Insignia.

(b) *When mounted.* --Same as (a) above omitting shoes, Army russet leather, and trousers, service, and adding--

1. Breeches, service (par. 32).

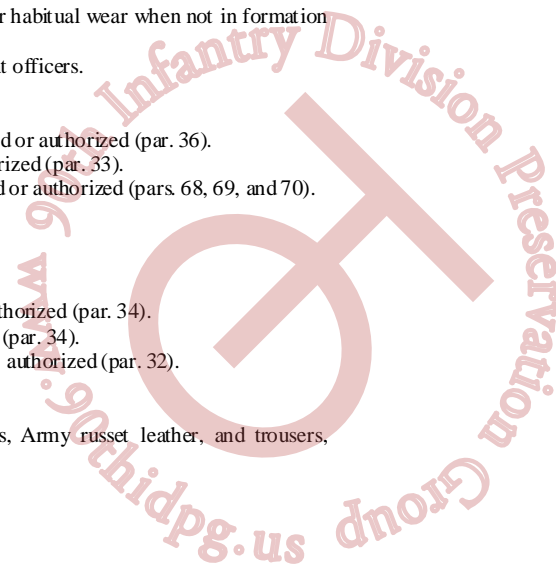

2. Boots (par. 34).
3. Spurs (par. 78).
- (c) *When on flying missions.* --Same as (a) above, omitting coat, service, and adding--
 - Optional
 1. Cap, garrison.
 2. Face mask.
 3. Muffler.
 4. Flying suit.
 5. Aviators' gloves, gauntlets, or mittens.
 6. Moccasins.
 7. Sweater or jacket.
 8. Helmet.
 9. Goggles.
 10. Flight jacket, type B-12. (Authorized for issue in theaters of operations only.)
- (d) Commanding officers of Army Air Forces stations may authorize the wear at their stations of the uniform prescribed for flying missions by officers of the Army Air Forces and flight officers when their duty is such that they may be called upon at any moment to engage in flying duty but such authorization will not allow the uniform for flying missions to be worn outside the limits of their posts, camps, or stations unless on duty which requires it.
- b. When acting as aide to the President of the United States, the sovereign or the chief executive of any foreign country, or any members of a reigning royal family.
 - (1) *By whom worn.* --All officers except those on duty at the White House.
 - (2) *Articles.*
 - (a) Cap, service.
 - (b) Coat, service.
 - (c) Decorations, service medals, and badges, unless otherwise prescribed.
 - (d) Gloves, dress, chamois or material of chamois color.
 - (e) Shirt, khaki.
 - (f) Shoes, Army russet leather.
 - (g) Socks, plain tan (or brown) when low shoes are worn.
 - (h) Trousers, service.
 - (i) Tags, identification.
 - (j) Necktie.
 - (k) Insignia.
- c. At the following official and social functions, the uniform will be the same as *b* above, except that dress gloves, white, will be worn instead of dress gloves, chamois:
 - (1) For the President or ex-President of the United States.
 - (2) At the White House.
 - (3) By or for the chief executive of any foreign country, or any member of a reigning royal family, members of the Cabinet, General of the Armies, the Chief of Staff, a former Chief of Staff, or the commander of an army, base command, defense command, service command, or officer of higher grade.
- d. *Other special occasions.*
 - (1) *On state occasions at home or abroad.* --Same as *b* above. See also paragraph 6.
 - (2) *At entertainments when it is desired to do special honor to the occasion.* --Same as *b* above, except that dress gloves, white, will be worn instead of dress gloves, chamois.
 - (3) *At social or official functions of a general nature, when prescribed.* --Same as *b* above, except that dress gloves, white, will be worn instead of dress gloves, chamois.
- e. *General and special courts martial, courts of inquiry, and retiring boards.* --By members thereof, same as *a* (2) (a) above.
- f. For habitual wear in formation under arms, except as otherwise prescribed in these regulations. See also paragraph 3.
 - (1) *By whom worn.* --All officers, warrant officers, and flight officers.
 - (2) *Articles.*
 - (a) *When dismounted.* --Same as *a* (2) (a) above, and adding belt, pistol or revolver, M1912.
 - (b) *When mounted.* --Same as *a* (2) (b) above, and adding belt, pistol or revolver, M1912.
 - (c) *When on flying missions.* --Same as *a* (2) (c) above.
- g. *Field duty*
 - (1) *By whom worn.* -- All officers, warrant officers, and flight officers.
 - (2) *Articles.*
 - (a) *When dismounted.*
 1. Liner, helmet, except when other headgear is prescribed or authorized.
 2. Jacket, field, except when shirt without coat is authorized (pars. 33 and 37).
 3. Leggings, canvas, except when boots are authorized (par. 34).
 4. Ribbons, service, optional (par. 73).
 5. Shirt, service (par. 40).
 6. Shoes, high, Army russet leather.
 7. Tags, identification (par. 44).
 8. Trousers, service (par. 43).
 9. Web field equipment (par. 79).

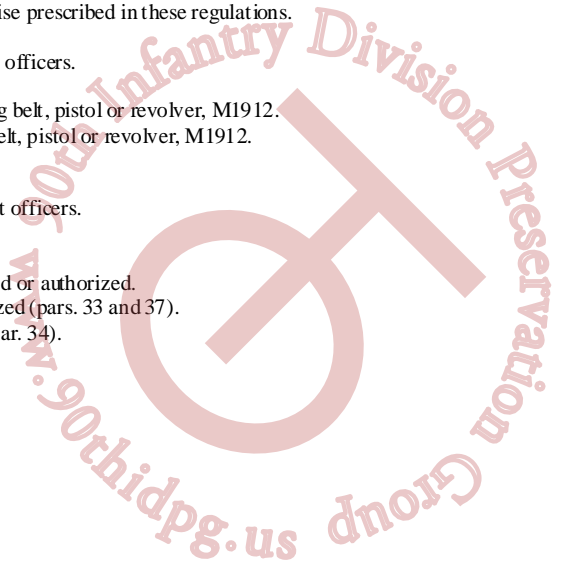

10. Pistol (par. 76).
11. Socks.
12. Insignia.
- (b) *When mounted.*--Same as (n) above, omitting 3, 6, and 8 and adding--
1. Breeches, service (par. 32).
 2. Boots (par. 34) and socks.
 3. Spurs (par. 78).
 4. Gloves, leather, when prescribed.
- (c) *When on flying missions.* --Same as a (2) (c) and (a) above, except that web field equipment need not be worn.
9. Service uniform, arms, and equipment for enlisted men, except aviation cadets. --a. For habitual wear when not under arms, except as otherwise prescribed in these regulations.
- (1) *By whom worn.* --All enlisted men except aviation cadets.
- (2) *Articles.*
- (a) *When dismounted.*
1. Cap, garrison, except when other headgear is prescribed or authorized (par. 36).
 2. Coat, service, except when shirt without coat is authorized by the commanding officer (par. 33).
 3. Decorations, service medals, and badges as prescribed or authorized (pars. 68, 69, and 70).
 4. Gloves (par. 35).
 5. Necktie (par. 39).
 6. Ribbons, service, optional (par. 73).
 7. Shirt (par. 40).
 8. Shoes, service, except when boots are authorized (par. 34).
 9. Socks, plain tan (or brown) when low shoes are worn.
 10. Trousers, service (par. 43), except when breeches are authorized (par. 32).
 11. Tags, identification.
 12. Insignia.
- (b) *When mounted.* --Same as (a) above, omitting 4, 8, and 10 and adding
1. Breeches, service (par. 32).
 2. Boots (par. 34).
 3. Gloves, leather (par. 35).
 4. Spurs (par. 78).
- (c) *While flying.* --Same as (a) above, omitting coat, service, and adding--
- Optional*
1. Cap, garrison.
 2. Muffler.
 3. Flying suit.
 4. Aviators' gloves, gauntlets, or mittens.
 5. Moccasins.
 6. Sweater or jacket.
 7. Helmet.
 8. Goggles.
 9. Face mask.
- (d) Commanding officers of Army Air Forces stations may authorize the wear at their stations of the uniform prescribed for flying missions by enlisted men of the Army Air Forces when their duty is such that they may be called upon at any moment to engage in flying duty but such authorization will not allow the uniform for flying missions to be worn outside the limits of their posts, camps, or stations unless on duty which requires it.
- b. For habitual wear under arms, except as otherwise prescribed in these regulations.
- (1) *By whom worn.* --All enlisted men except aviation cadets.
- (2) *Articles.*
- (a) *When dismounted.* --Same as a (2) (a) above, adding--
1. Belt, web, pistol, revolver, or carbine M36 (par. 77).
 2. Arms as per arm or service.
- (b) *When mounted.* --Same as a (2) (b) above, adding--
1. Belt, pistol, revolver, cartridge or magazine (par. 77).
 2. Arms as per arm or service.
- c. *For field duty.*
- (1) *By whom worn.* --All enlisted men except aviation cadets.
- (2) *Articles.*
- (a) *When dismounted.*
1. Liner, helmet, steel, except when other headgear is prescribed or authorized (par. 36).
 2. Jacket, field, except when shirt without coat is authorized (pars. 33 and 37).
 3. Leggings, canvas, except when boots are authorized (par. 34).
 4. Ribbons, service (par. 73).
 5. Shirt, service (par. 40).
 6. Shoes, service, and socks.
 7. Tags, identification (par. 44).
 8. Trousers, service (par. 43).

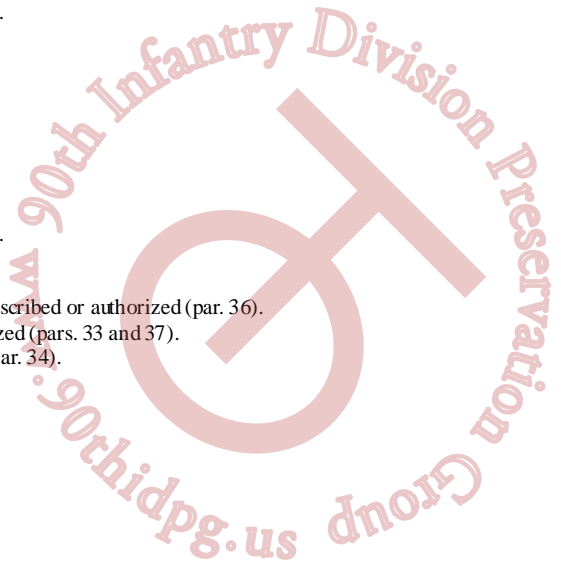

9. Web field equipment.
10. Arms as per arm or service.
11. Insignia.
 - (b) *When mounted.* --Same as (a) above, omitting 3, 6, and 8 and adding--
 1. Breeches, service (par. 32).
 2. Boots (par. 34).
 3. Spurs (par. 78).
 4. Gloves, leather, when prescribed.
 - (c) *While flying.* --Some as a (2) (c) and (a) above, except that web field equipment need not be worn.
10. Service uniform, arms, and equipment for aviation cadets. --a. For habitual wear when not under arms except as otherwise prescribed in these regulations (par. 2).
 - (1) *By whom worn.* --All aviation cadets and aviation students.
 - (2) *Articles.*
 - (a) 1. Cap, garrison, or service.
 2. Coat, service, except when shirt without coat is authorized (par. 33).
 3. Decorations, service medals, and badges as prescribed or authorized (pars. 68, 69, and 70).
 4. Gloves, leather, Army russet or cotton, white, when prescribed.
 5. Ribbons, service, optional.
 6. Shirt (par. 40).
 7. Shoes and socks.
 8. Trousers.
 9. Chevrons.
 10. Tags, identification.
 - (b) *When on flying missions.* --Same as (a) above, omitting articles in 2 and 4, and adding—

Optional

 1. Face mask.
 2. Muffler.
 3. Flying suit.
 4. Aviator's gloves, gauntlets, or mittens.
 5. Moccasins.
 6. Sweater or jacket.
 7. Helmet.
 8. Goggles.
 - (c) Commanding officers of Army Air Forces stations may authorize the wear at their stations of the uniform prescribed, for flying missions, for aviation cadets when their duty is such that they may be called upon at any moment to engage in flying duty but such authorization will not allow the uniform for flying missions to be worn outside the limits of their posts, camps, or stations unless on duty which requires it.
- b. For habitual wear under arms except as otherwise prescribed in these regulations.
 - (1) *By whom worn.* --All aviation cadets.
 - (2) *Articles.* --Same as a (2) (a) above, omitting 1 and adding--
 - (a) Belt, web, cartridge.
 - (b) Rifle.
11. Work uniform for officers, warrant officers, flight officers, and enlisted men. --May be worn either over or without the service uniform.
 - a. *Occasion.* --On duty in the performance of which the clothing worn may become soiled or unsightly. It may be worn for drill, combat, and simulated combat.
 - b. *Articles.*
 - (1) Cap, herringbone twill.
 - (2) Gloves (when conditions require them).
 - (3) Hat, herringbone twill (other authorized headgear may be worn when climatic or service conditions make it advisable).
 - (4) Shoes, service.
 - (5) Suit, one-piece herringbone twill (or jacket and trousers, herringbone twill).
 - c. The cap, herringbone twill, and the suit, herringbone twill, will be worn by personnel of the Armored Center and units and by mechanics only of the other arms and services. The hat, herringbone twill, and jacket and trousers, herringbone twill, will be worn by all other personnel.
12. White uniform for enlisted men. --When their duty requires it, white uniforms will be worn by cooks and bakers and certain members of the Medical Corps. It will not be worn at other times.
13. Oilskin clothing. --Oilskin clothing, including hats and rubber boots, may be worn by personnel of mine batteries, mine planters, and cable ships, and by other personnel for whom it is especially authorized.

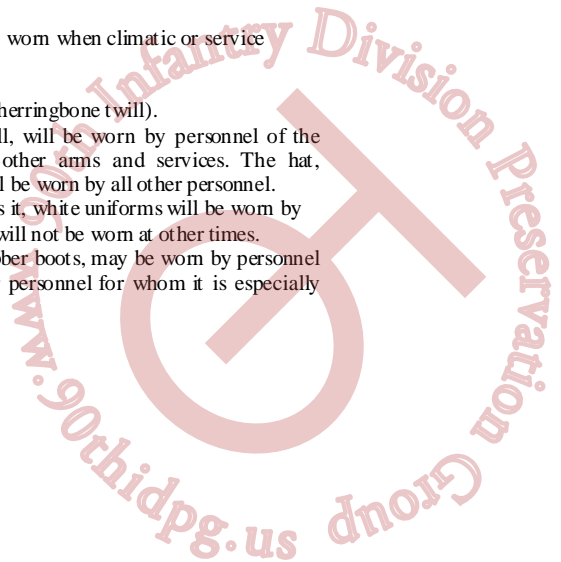

SECTION II

VARIOUS CLASSES OF PERSONNEL

	Paragraph
Officers _____	14
Female medical officers _____	15
Contract surgeons _____	16
Warrant officers and flight officers _____	17
Enlisted men _____	18
Bands _____	19
Civilians _____	20
Representatives of authorized civilian organizations _____	21
Officers' Reserve Corps _____	22
Officers appointed in the Army of the United States _____	23
Enlisted Reserve Corps _____	24
Certain persons who served in time of war _____	25
Persons not in Army, Navy, or Marine Corps _____	26
Honorably discharged personnel en route home _____	27
Army Hostess and Librarian Service _____	28
Army Nurse Corps, physical therapy aides, and hospital dieticians _____	29
Women's Army Corps _____	30

14. Officers. --a. *In general.*

- (1) All officers will provide themselves with the uniforms, arms, and personal equipment pertaining to their grade and duty, and will maintain them in a thoroughly neat and serviceable condition.
- (2) Officers will, by their appearance, set an example for neatness and strict conformity to regulations in uniform and equipment.
- (3) Officers, especially organization and detachment commanders, will impress upon all in the military service that the dignity of the uniform and the respect due it are best preserved when its wearers so conduct themselves as never to cast discredit upon it.

b. *Commanding officers.*

- (1) Commanding officers will see that all officers have uniforms as prescribed, in accordance with these regulations.
- (2) Commanding officers will inspect and verify the service uniforms, arms, and field equipment of personnel under their respective commands as often as they may deem necessary in order to assure themselves that all members thereof are prepared to take the field upon short notice, fully uniformed and equipped, as prescribed.

c. *Company and detachment commanders.* --Company and detachment commanders will be held responsible for the appearance of their men at all times, will encourage them to keep their uniforms clean and neat, and will do everything possible to facilitate the proper care, cleaning, and preservation of their uniforms. See paragraph 16b.

d. *Chaplains.*

- (1) When vestments are required or permitted by the church to which the chaplain belongs, he is authorized to use such while conducting religious services. For optional use while conducting services and religious ceremonials, chaplains may wear the chaplain's scarf described in paragraph 62½ AR 600-35.
- (2) When work uniform is worn, chaplains will, without exception, wear the insignia of service as prescribed for the shirt.

e. *Retired.*

- (1) Retired officers on active duty will wear the uniform prescribed for officers on the active list.
- (2)(a) The uniform of retired officers not on active duty will be, at their option, either that for officers of corresponding grade and arm or service at date of retirement, or that for officers on the active list, but the two uniforms will not be mixed, nor will the insignia of the arm or service be worn.
- (b) If, however, in time of war an officer of the Regular Army rendered honorable service, honorably terminated, in a higher grade than that in which he was retired, such officer after retirement, when not on active duty, may wear at his option, on occasions of ceremony, either the uniform of such higher grade or that of the grade in which he was retired.
- (3) Retired officers, not on an active duty status, when attending ceremonies and social functions of an official character, or when calling at or visiting the White House, may wear the appropriate civilian dress for the occasion, except that when attending New Year's Day receptions in formation with officers on the active list they will wear uniform.

15. Female medical officers. --a. *General.* --Female medical officers will wear the uniform prescribed for officers of the Women's Army Corps (see AR 600-39), with the exception of the cap, WAC, and insignia, WAC. They will wear either the cap, female, medical officers', or the cap, garrison, officers'.

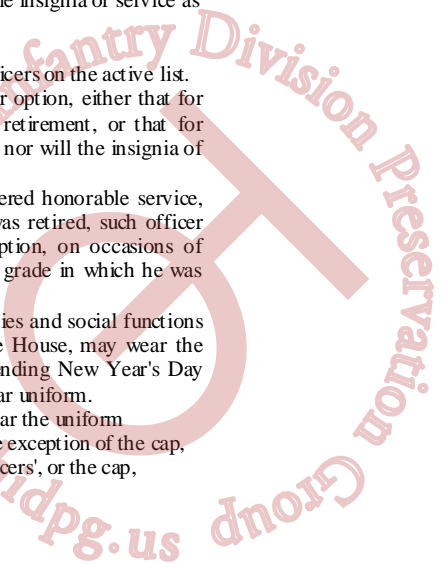

b. Insignia. --Insignia as described in AR 600-35 will be worn in the manner prescribed in these regulations.

c. Female medical officers are authorized to wear slacks, khaki shade No. 1, with the summer uniform or slacks of wool, olive-drab shade No. 51, with the winter uniform under such conditions as the immediate commanding officer of the individual officer concerned may deem appropriate. Slacks will conform to the design described in AR 600-37.

d. Utility bag. --To be of commercial design, Army russet in color. May be worn without the shoulder strap.

16. Contract surgeons. --Contract surgeons may, when on duty and with the approval of the commanding officer concerned, wear the uniform of commissioned officers, including prescribed insignia (AR 600-35 or par. 15 as applicable). The wearing of uniforms is optional with the contract surgeon and will not be required.

17. Warrant officers and flight officers. --Except as otherwise prescribed, warrant officers and flight officers will, under the same conditions, wear the same uniform as commissioned officers.

18. Enlisted men. --*a. General.* --Enlisted men will not wear an article of uniform of a type different from that which is issued to the organization to which they belong, except as authorized in these regulations.

b. On pass or furlough.

(1) Enlisted men will be inspected as they go on and again as they return from pass or furlough. Men who do not present a neat appearance will not be allowed to depart, and men who return in an untidy or dirty condition will be disciplined.

(2) All officers will observe the appearance of the enlisted men seen on pass or furlough and will report those who are in an untidy or dirty condition.

c. Retired. --Retired enlisted men may wear the uniform prescribed at the date of their retirement, except that the insignia of arm or service will be omitted. When placed on active duty they will wear the uniform prescribed for enlisted men on the active list.

d. Aviation students. --Notwithstanding provisions of these regulations to the contrary, enlisted men eligible for appointment as aviation cadets who, under instructions issued by the Commanding General, Army Air Forces, are detailed as aviation students, pursuant to AR 615-150, in lieu of appointment as aviation cadets, to pursue courses of training for aviation cadets, will wear the uniform prescribed for aviation cadets. See paragraph 10.

19. Bands. --Commanding officers may, from regimental, band, or similar funds, provide for members of bands such additional unprohibited ornaments as they may deem proper. Such ornaments will not include officers' insignia of grade nor any other article specially prescribed for officers, nor will they include shoulder knots, shoulder straps, or trouser stripes. The ornaments authorized are limited to additional articles for the purpose of adorning the uniform. Any alteration in the prescribed articles of uniform or substitution of articles of uniform or equipment will not be made without the approval of the War Department.

20. Civilians. --*a. Employees in forces of Army of United States and civilian personnel of all United States military missions in theaters of operations and in oversea garrisons.* --Chauffeurs, messengers, airmen, mechanics, and other civilians for whom other uniforms are not authorized, having a status recognized by the War Department as part of the forces, and civilian personnel of all United States military missions in theaters of operations and in oversea garrisons, will wear either winter or summer service uniform, and other articles of special clothing required by climatic conditions, without insignia, or the civil uniform appropriate to their employment, as prescribed by the commanding general; and a sleeve emblem (combatant or noncombatant, as applicable), as prescribed in AR 600-35, attached permanently to the left sleeve of the outer garment, midway between the elbow and shoulder.

20. Civilians. --*a. War Department employees in forces of Army of United States and civilian personnel of all United States military missions in theaters of operations and in oversea garrisons.*

(1) *General.* --Civilians having a status recognized by the War Department as part of the forces, and civilian personnel of all United States military missions in theaters of operations and in oversea garrisons will wear either winter or summer service uniform, or the civil uniform appropriate to their employment, as prescribed by the commanding general.

(2) Wearing of the uniform.

(a) If worn, the service uniform will be either officer or enlisted depending on the assigned assimilated rank. Other articles of special clothing required by climatic conditions may be prescribed. The service uniform or special clothing will be worn without insignia of grade or arm or service.

(b) When the service coat is worn as an outer garment, the metal letters "US" will be worn on both sides of the collar. When the service shirt is worn as an outer garment the metal letters "US" will be worn on both tabs of the collar. The metal letters "US" will be worn on the garrison cap, and the officer's device on the service cap by those having the assimilated rank of an officer.

(c) A shoulder sleeve insignia as prescribed in AR 600-35, for civilians accompanying United States Army forces in the field, will be attached permanently to the outer half of the left sleeve of the outer garment, the top of the insignia to be $\frac{1}{2}$ below the top of shoulder seam.

b. Employees of the War Department for duty in education and recreation work and by certain of the national welfare societies. --In time of war, such uniform as prescribed by the War Department.

c. Civilians attached to and authorized to accompany forces of the Army of the United States in the

theater of operations.

- (1) Newspaper correspondents, photographers, radio commentators, technical observers, and service specialists will wear the officer's uniform without insignia of grade or arm or service; their messengers and chauffeurs will wear the uniform of an enlisted man without insignia. All will wear a brassard as prescribed in AR 600-35.
- (1) War correspondents, chauffeurs, messengers, photographers, radio commentators, technical observers, scientific consultants, operation analysts, AAF technical representatives, and automotive advisors will wear the officer's or enlisted man's uniform depending on the assigned assimilated rank, without insignia of grade or arm or service. The metal letters "US" will be worn on both sides of the collar of the service coat and on both tabs of the collar of the service shirt, when these articles of clothing are worn as an outer garment. The metal letters "US" will be worn on the garrison cap, and the officer's device on the service cap by those having the assimilated rank of an officer. All will wear the appropriate shoulder sleeve insignia for civilians accompanying United States Army forces in field as prescribed in AR 600-35.
- (2) Postal employees and other civilians will wear such distinctive clothing or uniforms and brassards as may be prescribed by the War Department.
- (2) Other civilians who are not classified under any of the designations contained in (1) above will wear the same uniform and insignia, except that the shoulder sleeve insignia will be worn without any specified designation, provided distinctive clothing or uniforms have not separately been prescribed for such civilians by the War Department.

d. The authorized military uniform may be worn--

- (1) When preparing for departure oversea.
- (2) During a period of temporary duty in the United States from an oversea theater.
- (3) Until termination of appointment. [AG 421 (6 Sep 44)]

21. Representatives of authorized civilian organizations. --Representatives of civilian organizations authorized by the Secretary of War to engage in soldier welfare activities will wear the uniform of their respective organizations when with the Army of the United States either at home or abroad, provided such uniform has been approved by the Secretary of War.

22. Officers' Reserve Corps. --*a.* Except as otherwise prescribed, a Reserve officer on active duty will wear the uniform, including insignia, prescribed for officers of the Regular Army.

- b.* (1) Reserve officers not members of the Regular Army, not on active duty and within the limits of the United States or its possessions, may wear the uniform on occasions of military ceremony, at social functions and informal gatherings of a military character, and when engaged in the military instruction of a cadet corps or similar organization, or when responsible for the military discipline at an educational institution. Such Reserve officers may also wear the uniform when attached to an organization for target practice, when visiting a military station for participation in military drills or exercises, or when assembled for the purpose of instruction.
- (2) Reserve officers not on active duty and outside the United States or its possessions will not, except when granted authority by the War Department, wear the uniform. Such officers on occasions of military ceremony or other military functions may, upon reporting to the nearest military attaché and having their status accredited, be granted authority to appear in uniform. In a country to which no military attaché is accredited, authority to wear the uniform for a specific occasion should be obtained from the proper civil or military authorities of the country concerned. See also paragraph 6.
- (3)(*a*) Warrant officers, flight officers, and enlisted men of the Regular Army who hold commissions in the Officers' Reserve Corps may wear the uniform of their grade in the Officers' Reserve Corps as follows:
 1. When undergoing voluntary training designed for Reserve officers which they have been authorized to take by proper authority, and in going to and returning from this training.
 2. When attending meetings or functions of associations formed for military purposes, the membership of which is composed largely or entirely of officers of the Army of the United States or of former members of the service.
- (b)* The uniform of the Reserve grade will not be worn by warrant officers, flight officers, and enlisted men of the Regular Army in an office of the Military Establishment, or at places where they would come into contact with troops of the Regular Army, or of the National Guard when called into Federal service, except when the wearer is on active duty as a Reserve officer or as is otherwise authorized in this paragraph.

c. (1) Reserve officers assigned to active units and organizations of the Regular Army will wear the insignia of such unit or organization whether on active or inactive status.

(2) Members of the Officers' Reserve Corps will provide themselves with service uniforms with insignia of the arm or service in which commissioned, for use when ordered to active duty. Other than clothing, all articles of equipment needed by such officers will be issued to them when on active duty in accordance with authorized allowances.

23. Officers appointed in Army of the United States. --Officers appointed in the Army of the United States on active duty will wear the uniform prescribed for officers of the Regular Army, except that the appropriate insignia will be as prescribed in paragraph 49. Such officers, not on active duty, may wear the uniform under the provisions of paragraph 22 pertaining to Reserve officers not on active

duty.

24. Enlisted Reserve Corps. --Members of the Enlisted Reserve Corps on active duty will wear the uniform and insignia of the arm or service to which they are assigned and when not on active duty may wear the prescribed uniform under conditions similar to those set forth in paragraph 22b (1) and (2). See also paragraph 6. They will wear the prescribed uniform and insignia when undergoing instruction as students of the Army Specialized Training Reserve Program.

25. Persons who served honorably in time of war. --a. All persons who have served honorably in the Army, Navy Marine Corps, and/or Coast Guard of the United States during war shall, when not in the active military and/or naval service of the United States, be entitled to bear the official title and upon occasions of ceremony, to wear the uniform of the highest grade held by them during their war service. See sec. 2, act of June 21, 1930 (46 Stat. 793; 10 U. S. C. 1028b; 34 U. S. C. 399d; M. L. 1939, sec. 2150).

b. The uniform to be worn under the foregoing provisions will be, at the option of the wearer, either that prescribed for officers of corresponding grade in their arm or service at date of separation from the service, or that prescribed for officers on the active list, except that the uniforms will not be mixed, and the insignia of arm or service will not be worn.

c. As used in the act referred to in a above, the phrase "occasions of ceremony" means occasions essentially of a military character at which the uniform is more appropriate than civilian clothing, e.g., memorial services, military weddings, military funerals, military balls, military parades, and meetings or functions of associations formed for military purposes, the membership of which is composed largely or entirely of honorably discharged veterans of the services or of Reserve personnel. Authority to wear the uniform under the act, and under this interpretation, includes authority to wear the uniform while traveling to and from the ceremony, provided such travel in uniform can be completed on the day of the ceremony. [A. G. 421 (7 Aug. 44.) (C 1, 11 Aug 44.)

26. Persons not in Army, Navy, or Marine Corps. --a. It shall be unlawful for any person not an officer or enlisted man of the United States Army, Navy, or Marine Corps, to wear the duly prescribed uniform of the United States Army, Navy, or Marine Corps, or any distinctive part of such uniform, or a uniform any part of which is similar to a distinctive part of the duly prescribed uniform of the United States Army, Navy, or Marine Corps: *Provided*, That the foregoing provisions shall not be construed so as to prevent officers or enlisted men of the National Guard from wearing, in pursuance of law and regulations, the uniform lawfully prescribed to be worn by such officers or enlisted men of the National Guard; nor to prevent members of the organization known as the Boy Scouts of America, or the Naval Militia, or such other organizations as the Secretary of War, or the Secretary of the Navy may designate, from wearing their prescribed uniforms; nor to prevent persons who in time of war have served honorably as officers of the United States Army, Navy, or Marine Corps, Regular or Volunteer, and whose most recent service was terminated by an honorable discharge muster out, or resignation, from wearing, upon occasions of ceremony, the uniform of the highest grade they have held by brevet or other commission in such Regular or Volunteer service; nor to prevent any person who has been honorably discharged from the United States Army, Navy, or Marine Corps, Regular or Volunteer, from wearing his uniform from the place of his discharge to his home, within three months after the date of such discharge; nor to prevent the members of military societies composed entirely of honorably discharged officers or enlisted men, or both, of the United States Army, Navy, or Marine Corps, Regular or Volunteer, from wearing, upon occasions of ceremony, the uniform duly prescribed by such societies to be worn by the members thereof; nor to prevent the instructors and members of the duly organized cadet corps of a State university, State college, or public high school offering a regular course in military instruction from wearing the uniform duly prescribed by the authorities of such university, college, or public high school for wear by the instructors and members of such cadet corps; nor to prevent the instructors and members of the duly organized cadet corps of any other institution of learning offering a regular course in military instruction, and at which an officer or enlisted man of the United States Army, Navy, or Marine Corps is lawfully detailed for duty as instructor in military science and tactics, from wearing the uniform duly prescribed by the authorities of such institution of learning for wear by the instructors and members of such cadet corps; nor to prevent civilians attendant upon a course of military or naval instruction authorized and conducted by the military or naval authorities of the United States from wearing, while in attendance upon such course of instruction, the uniform authorized and prescribed by such military or naval authorities for wear during such course of instruction; nor to prevent any person from wearing the uniform of the United States Army, Navy, or Marine Corps in any playhouse or theater or in moving-picture films while actually engaged in representing therein a military or naval character not tending to bring discredit or reproach upon the United States Army, Navy, or Marine Corps: *Provided further*, That the uniforms worn by officers or enlisted men of the National Guard, or by the members of the military societies or the instructors and members of the cadet corps referred to in the preceding proviso shall include some distinctive mark or Insignia to be prescribed by the Secretary of War or the Secretary of the Navy to distinguish such uniforms from the uniforms of the United States Army, Navy, and Marine Corps: *And provided further*, That the members of the military societies and the instructors and members of the cadet corps hereinbefore mentioned shall not wear the insignia of rank prescribed to be worn by officers of the United States Army, Navy, or Marine Corps, or any insignia of rank similar thereto.

Any person who offends against the provisions of this section shall, on conviction, be punished by a fine not exceeding \$300, or by imprisonment not exceeding six months, or by both such fine and imprisonment. Sec. 125, National Defense Act, as amended by act June 4, 1920 (41 Stat. 836), and

act at June 30, 1921 (10 U. S. C. 1393; M. L. 1939, secs. 2148-2151, 2153-2157).

Section one hundred and twenty-five * * * shall apply to the Coast Guard in the same manner as to the Army, Navy, and Marine Corps. Act 29 August 1916 (39 Stat, 649).

b. Distinctive articles of the uniform of the United States Army are as follows:

- (1) Badges of qualification.
 - (2) Buttons, uniform, United States Army.
 - (3) Buttons, uniform, Corps of Engineers (officers).
 - (4) Cap, service, officers.
 - (5) Cap, service, enlisted men.
 - (6) Cap, officers, dress, white.
 - (7) Cap, officers, dress, blue.
 - (8) Cap, female medical officers.
 - (9) Coat, service, all types.
 - (10) Coat, officers, dress, white.
 - (11) Coat, officers, dress, blue.
 - (12) Decorations, medals and their appurtenances.
 - (13) Helmets, steel, M-1, and helmet, liner.
 - (13) Rescinded. [AG 421 (24 Mar 45)]
 - (14) Insignia of identification or grade adopted by the War Department, United States Army.
 - (15) Overcoats, officers, short and long.
 - (16) Overcoat, enlisted men, wool, olive-drab.
 - (17) Any article of the uniform which includes ornamentation adopted by the War Department or any garment which is of the same design as a distinctive article of the uniform.
27. Honorably discharged personnel en route home. Section 125, National Defense Act, as amended (see par. 26), permits any person who has been honorably discharged from the United States Army to wear his uniform from place of discharge to his home, within 3 months after his date of discharge. This also applies to officers and enlisted men who are separated from the service under honorable conditions or transferred to an inactive status. After arrival at home, it is unlawful to wear the uniform except under the provisions of paragraph 25.
28. Army Hostess and Librarian Service. --See AR 600-36.
29. Army Nurse Corps, physical therapy aides, and hospital dieticians. --See AR 600-37.
30. Women's Army Corps. --See AR 600-39.

SECTION III

VARIOUS ARTICLES OF CLOTHING

	Paragraph
Belt, waist _____	31
Breeches, service _____	32
Coats _____	33
Footgear _____	34
Gloves _____	35
Headgear _____	36
Jacket, field _____	37
Muffler, wool, olive-drab _____	38
Necktie _____	39
Shirt _____	40
Suspenders _____	41
Sweater _____	42
Trousers, service _____	43
Tag, identification _____	44
Parachutists' clothing _____	45
Combat winter clothing _____	46
Underclothing and socks _____	47

31. Belt, waist. --The waist belt will be worn when the service shirt is worn without the coat. It may be worn at other times.

32. Breeches, service. --a. *By whom worn.*

- (1) Officers who are required to be mounted as specified in AR 605-130 when on mounted duty.
- (2) Personnel of animal-mounted, animal-drawn, or pack organizations (except pack units of Field Artillery) may wear breeches at all times.

b. *When worn* --Olive-drab (dark shade) breeches will be worn by officers when in the field. Drab (light shade) breeches may be worn by officers at other times. Drab breeches are an article optional with the individual officer.

33. Coats. --a. *General.* --All coats will be buttoned throughout whenever worn. The summer coat is for optional wear. Commanding officers will neither require the purchase nor prescribe the wearing of this coat by officers of their commands.

b. *Overcoat.* --The wearing of the overcoat, field, long, or the overcoat, short, is optional with the

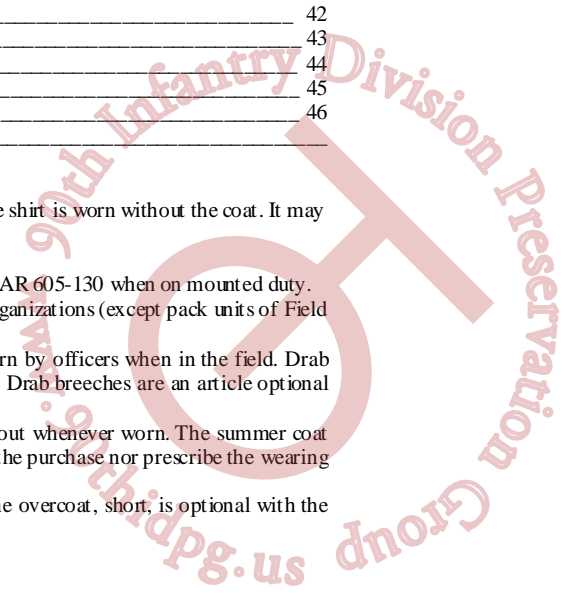

individual officer under all conditions. Commanding officers will neither require the purchase nor prescribe the wearing of either of these coats to the exclusion of the other.

c. Raincoat. --When in a situation involving exposure to rainy or other inclement weather, officers may wear raincoats of commercial pattern, with shoulder loops, color, olive-drab No. 7, or the outer shell of the overcoat, field, long.

d. Mackinaw. --May be prescribed by the commanding officer for wear by enlisted men who are issued the item when conditions warrant.

34. Footgear. --*a. Boots, leather.*

(1) Officers who are required to be mounted, as specifically prescribed in AR 605-130, will wear boots when on mounted duty.

(2) Personnel of animal-mounted, animal-drawn, or pack organizations (except pack units of Field Artillery) may wear boots at all times.

b. Boots, rubber. --When conditions warrant, rubber boots may be prescribed by commanding officers of posts, camps, and stations and of mine planters, cable ships, and transports.

c. Leggings, canvas. --Worn with high shoes by all officers and enlisted men except those of animal-mounted, animal-drawn, or pack organizations (except pack units of Field Artillery) when prescribed by the commanding officer.

d. Shoes, low. --May be worn with plain tan (or brown) socks by officers and enlisted men when authorized by the commanding officer.

e. Overshoes. --When conditions warrant, overshoes may be prescribed by the commanding officer. They are optional when not in formation.

f. Shoes, service. --Optional for officers. Worn habitually by enlisted men unless other footgear is prescribed.

g. Boots, combat. --Worn in combat or simulated combat when issued, and as prescribed by the commanding officer.

35. Gloves. --*a. Dress, chamois, or chamois colored material.* --Worn by officers when prescribed, optional when off duty.

b. Dress, white. --Worn by officers at official and social functions as prescribed in these regulations and at formations when troops wear white gloves.

c. Leather, Army russet. --Worn by officers and men of mounted organizations and officers of other organizations when prescribed. Optional when off duty.

d. Wool, olive-drab. --Worn by officers and men when prescribed and optional when off duty.

36. Headgear. --*a. General.* --Commanding officers may prescribe the wearing of such authorized headgear in possession of their troops so as to protect fully the health of their commands under existing climatic conditions.

b. Cap, garrison. --Authorized for wear by all personnel.

c. Cap, service.

(1) Authorized for wear by all officers, warrant officers, and flight officers when not in formation with troops.

(2) Authorized for wear by enlisted men when issued.

d. Hat, field, cotton, olive-drab. --As prescribed.

e. Cap, field, pile. --As prescribed.

f. Cap, wool, knit, M1941. --Authorized for wear by all officers and enlisted men in cold weather localities either with or without the helmet, steel, and liner. In mild weather the curtain may be turned up and in extreme weather the cap, wool, knit, M1941, may be turned inside out with the curtain turned down.

g. Hat, service. --Authorized for wear by personnel of mounted units, by troops in Alaska, in oversea departments, and in localities where the cotton uniform is not worn at any time; and by officers when the cap, field, cotton, olive-drab, is worn by enlisted men.

h. Helmet, steel, and liner. --Authorized for wear by all personnel. In inclement weather, caused either by heavy rain, snow, hot sun, or excessive glare, the helmet liner may be authorized for optional wear by commanding officers.

37. Jacket, field. --The field jacket may be worn within the limits of posts, camps, or stations, and then only when prescribed by the commanding officer of the unit involved. It will not be worn outside the limits of the post, camp, or station except when appropriate to the discharge of an assigned mission, and then only when prescribed by the commanding officer thereof. In maneuver areas the uniform will be as prescribed by the commanding general thereof.

38. Muffler, wool, olive drab. --The muffler, wool, olive drab, is for optional wear when an overcoat is worn. Commanding officers will neither require the purchase nor prescribe the wearing of a muffler by officers of their commands.

39. Necktie. --*a.* The necktie will be worn when the service coat is worn and when the olive-drab wool or khaki shirt is worn without the coat except as indicated in *b* below.

b. Neckties will not be worn in the field or under simulated field conditions.

c. When the shirt is worn without the coat, the necktie will be tucked into the shirt between the first and second visible buttons.

40. Shirt. --Any prescribed or authorized shirt may be worn when the service coat is worn. Commanding officers may authorize the wearing of the wool or cotton shirt without the coat. When the shirt is worn as an outer garment elastic or other arm bands will not be worn.

41. Suspenders. --Suspenders may be worn but must not be visible.

42. Sweater. --Sweaters may be worn under the service coat or field jacket but will not be visible.

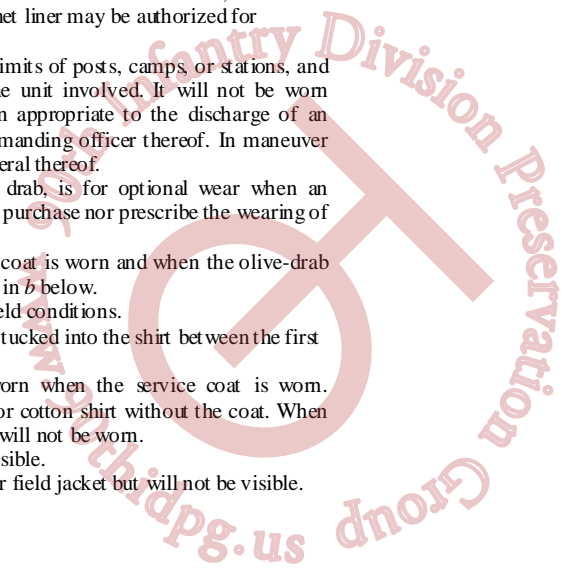

43. Trousers, service. --*a. By Whom Worn.* --All personnel not specifically authorized to wear breeches will wear trousers. Personnel authorized to wear breeches may wear trousers when not on duty requiring them to be mounted.

b. When Worn.

- (1) Olive-drab (dark shade) trousers will be worn by officers when in the field.
- (2) Drab (light shade) trousers may be worn by officers at other times
- (3) Drab trousers are an article optional with the individual officer.

44. Tag, identification. --Identification tags will be worn by each member of the Army at all times, with either uniform or civilian clothing, and may be removed temporarily only as the necessities of personal hygiene may require; one tag to be suspended from the neck underneath the clothing by a 25-inch noncorrosive, nontoxic, and heat-resistant material looped to form a necklace, and the second tag fastened to the necklace below the first tag by a 2½-inch extension of material similar to necklace. These tags are a part of the uniform and will be habitually worn by the owner. The tags, embossed as provided in AR 600-35, will be issued to each member of the Army as soon as practicable after entry into service.

45. Parachutists' clothing. --To be worn as prescribed by the commanding officer.

46. Combat winter clothing. --To be worn as prescribed by the commanding officer.

47. Underclothing and socks. --Underclothing and socks will be provided for issue to all enlisted men according to climatic conditions.

SECTION IV

INSIGNIA

	Paragraph
General	48
Officers appointed in the Army of the United States	49
Insignia on headgear	50
Insignia on collar or lapel of coat, service	51
Insignia on shirt	52
Insignia on work clothing	53
Insignia on shoulder loop	54
Insignia on sleeve	55
Insignia, shoulder sleeve	56
Insignia, aviation cadets and enlisted aviation students	57
Insignia, Army Air Forces technical specialists	58
Insignia to denote excellence in Coast Artillery Corps	59
Insignia, flying instructors	60
Insignia of students, officer candidate schools	61
Insignia, bomb disposal personnel	62
Insignia to denote excellence of students, Army Specialized Training Program	63
Brassards	64
Emblem, sleeve, combatant, and emblem, sleeve, noncombatant	65
Detailed officers and enlisted men	66
Distinctive insignia and trimmings	67

48. General. --*a.* Reserve officers and officers of the National Guard in Federal service will wear the same insignia as officers of the Regular Army. See also paragraph 22c (1).

b. Members of the Regular Army, and members of the Organized Reserves whether on an active or inactive status, assigned to an inactive unit of the Regular Army, will wear the insignia of such unit. See also paragraph 22c (1).

c. An officer unassigned to an organization will wear the insignia of the arm, service, or bureau (without regimental number) in which he is commissioned or detailed as the case may be.

d. Commanding generals of independent forces outside the continental limits of United States operating directly under the War Department are authorized to prescribe the method of wearing insignia.

e. Wearing of the Military Intelligence Reserve insignia is suspended. Officers commissioned in the Military Intelligence Reserve will wear the insignia of the unit with which they are serving. If engaged in some duty not directly associated with a unit as, for example, the staff of a division, infantry insignia will be worn. [AG 421 (4 Sep 44)]

49. Officers appointed in Army of United States. --*a.* Officers appointed from civil life.

- (1) Officers appointed for duty in the Medical, Dental, Sanitary, Veterinary, Pharmacy or Medical Administrative Corps or for duty as chaplains will wear the insignia prescribed for those services.
- (2) All other officers appointed from civil life will wear the insignia of the Specialist Reserve during the initial 90-day period of active duty. Upon satisfactory completion of the

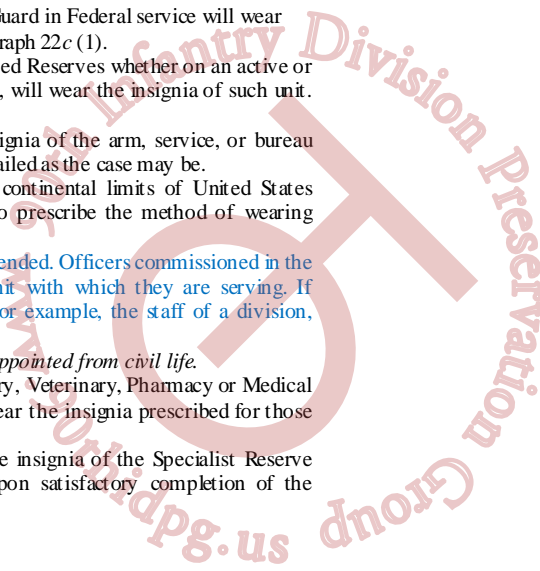

prescribed period and of an appropriate course of training, the appointee will, if then considered qualified, wear the insignia of the arm or service to which assigned. Unless and until assigned to or detailed in an arm or service, such officers will continue to wear the insignia of the Specialist Reserve.

b. Other officers appointed under AR 605-10. --Warrant officers and enlisted men, including graduates of officer candidate schools, appointed in the Army of the United States will wear the insignia of the arm or service to which assigned or, if commissioned for a branch immaterial position, the insignia of the Specialist Reserve.

c. All officers mentioned in *a* and *b* above will, upon relief from assignment to or detail in an arm or service, and upon assignment to a branch immaterial position not allotted to a particular arm or service, wear the insignia of their basic arm or service. See paragraph 2*a*, AR 605-145.

d. All officers mentioned in *a* and *b* above, will, upon relief from a branch immaterial position and upon detail in an arm or service, wear the insignia of the arm or service in which detailed. Upon relief from one arm or service and upon detail in another arm or service, they will wear the insignia of the arm or service in which detailed.

50. Insignia on headgear (see fig. 1). --*a.* The service cap insignia will be attached so as to be centered on the welt.

b. Distinctive insignia will be worn on headgear as prescribed in paragraph 67*d*.

c. The garrison cap insignia for aviation cadets will be worn on the left side, 1 inch from front of cap and ½ inch from bottom edge of cap.

d. Insignia of grade will be worn by officers, warrant officers, and flight officers on the garrison cap, on the left side, centered on the curtain, with center of the insignia 1½ inches from the front. Bars will be worn perpendicular to the bottom edge of the cap. Leaves will be worn with stem down. The eagle will be worn beak to the front. The star will be worn point upward. Additional stars will extend to the rear of the first star and be placed ⅝ inch apart. Miniature insignia of grade is authorized for general officers only, and when worn, additional stars will be placed 3/8 inch apart.

51. Insignia on collar or lapel of coat, service. --*a. In general.* --The insignia worn on the collar or lapel of the service coat will be of metal and will consist of

(1) The letters "U. S.", or the letters "U. S." with prescribed additions thereto.

(2) Insignia indicating the arm, service, etc., or the insignia with a prescribed addition thereto.

b. Officers and flight officers (see fig. 2 (1)).

(1) The letters prescribed in *a* (1) above will be worn on the collar horizontally, lower edge ½ inch above the horizontal line of lapel, the center of the "U. S." to be at center of the collar.

(2) The insignia prescribed in *a* (2) above will be worn horizontally on lapel, upper edge ½ inch below horizontal line of lapel and centered below "U. S."

c. Warrant officers (see fig. 2 (1)). --The same as for officers, as prescribed in *a* and *b* above, except that the insignia of warrant officers will be worn in lieu of the arm or service insignia.

d. Enlisted men except aviation cadets (see fig. 2 (2)).

(1) Disk insignia as issued will be worn on collar of the service coat centered on collar with center of insignia 1 inch above notch of lapel. Personnel not assigned to regiments will wear the "U. S." without numerical designation and the insignia of arm or service.

(*a*) Letters "U. S." with regimental number when applicable, or letters "U. S." with the authorized abbreviation of the name of the State and the regimental number when applicable, will be worn on the right collar. Enlisted men of the National Guard after induction into the Federal service will wear the letters "U. S." with the regimental number when applicable.

(*b*) The insignia of the arm or service will be worn on the left collar.

(2) Distinctive insignia, if authorized for wear, will be worn as prescribed in paragraph 67*d*.

e. Aviation cadets (see fig. 2 (1)). --The letters "U. S." and the Air Corps insignia placed as prescribed in *b* above.

52. Insignia on shirt. --When the shirt is worn without the service coat, insignia will be worn on the collar (see fig. 3) as follows:

a. General officers.

(1) *General of the Army.* --On both sides, 1 inch from the end, the circle of stars with one star upward.

(1)(2) *General officers of the line.* --On both sides, 1 inch from the end, the insignia of grade one point upward.

(2)(3) *Other general officers.* --On the right side, 1 inch from the end, the insignia of grade one point upward, on the left side, 1 inch from the end, metal insignia indicating arm, service, bureau, etc.

(3)(4) *Additional stars.* --Additional stars will, extend to the rear of the first star and be placed ⅝ inch apart.

(4)(5) *Miniatures.* --General officers are authorized to wear miniature insignia of grade.

Additional miniature stars will be placed 3/8 inch apart. [AG 421 (27 Jan 45)]

b. All officers and flight officers except general officers.

(1) On the right side, 1 inch from the end, the insignia of grade. Bars will be worn parallel with front edge of collar. Leaves will be worn with stem down. The eagle will be worn beak to the front.

(2) On the left side, 1 inch from the end, metal insignia indicating arm, service, bureau, etc.

c. Warrant officers. --On the right side, 1 inch from the end, the insignia of grade, on the left side, 1

inch from the end, the insignia of warrant officer. Bars will be worn parallel with the front edge of the collar.

53. Insignia on work clothing. --Insignia of grade and arm or service will be worn on work clothing as prescribed for the shirt.

54. Insignia on shoulder loop (see fig. 4). --*a.* On each shoulder loop of the service coat, the overcoat, the raincoat, and the field jacket, metal or embroidered insignia of grade will be worn, and on each shoulder of special suits or jackets of flying personnel, metal, embroidered, or leather insignia of grade will be worn as follows:

(1) *General of the Army.* --The circle of stars, one star upward, in the center of the loop, lower stars $\frac{3}{8}$ inch from sleeve end of loop. The coat of arms of the United States will be centered on shoulder loop midway between the upper star and the outer edge of the button.

(1)(2) *General.* --The four stars, points up, to be equidistant each from the other.

(2)(3) *Lieutenant general.* --The three stars, points up, to be equidistant each from the other.

(3)(4) *Major general.* --The centers of the two stars, points up, $\frac{1}{4}$ inches apart, the stars to be equidistant from the sleeve end of the loop and the outer edge of the button.

(4)(5) *Brigadier general.* --Star in center of loop, point up.

(5)(6) *Colonel.* --Eagle, head up, beak to the front, in middle of loop, talons of eagle $\frac{5}{8}$ inch from sleeve end of loop.

(6)(7) *Lieutenant colonel.* --Oak leaf, point up, in middle of loop, stem of leaf $\frac{5}{8}$ inch from sleeve end of loop.

(7)(8) *Major.* --Oak leaf, to be worn same as oak leaf of lieutenant colonel.

(8)(9) *Captain.* --The two bars, $\frac{1}{4}$ inch apart, in middle of loop, lower bar parallel to and $\frac{5}{8}$ inch from sleeve end of loop.

(9)(10) *First lieutenant.* --The bar in the middle of loop, parallel to and $\frac{5}{8}$ inch from sleeve end of loop.

(10)(11) *Second lieutenant.* --Same as first lieutenant.

(11)(12) *Warrant officers.*

(a) *Chief warrant officer.* --The bar in the middle of loop parallel to and $\frac{5}{8}$ inch from sleeve end of loop.

(b) *Warrant officer (junior grade).* --The bar in the middle of loop parallel to and $\frac{5}{8}$ inch from sleeve end of loop.

(12)(13) *Flight officers.* --The bar in the middle of loop, parallel to and $\frac{5}{8}$ inch from sleeve end of loop. [AG 421 (27 Jan 45)]

b. Distinctive insignia, if authorized for wear, will be worn as prescribed in paragraph 67*d.*

c. In combat and simulated combat (maneuvers, field conditions) the commanding generals of divisions or higher units, or the commanding officers of independent forces may, in their discretion, prescribe that insignia of grade be removed from and not worn on the shoulder loops of any or all of the items of uniform in *a* above, except the service coat.

55. Insignia on sleeve. --*a.* On overcoats for general officers (see fig. 5 (1)). The bands of black braid will be worn around both sleeves, the band $1\frac{1}{4}$ inches wide being placed with its lower edge $2\frac{1}{2}$ inches above and parallel to the end of the sleeve, and the band $\frac{1}{2}$ inch wide being placed with its lower edge $1\frac{1}{2}$ inches above the upper edge of and parallel to the other.

b. *Warrant officers, Army Mine Planter Service.* Warrant officers of the Army Mine Planter Service will wear the sleeve insignia of the Army Mine Planter Service on both sleeves of the service coat and overcoat, the bands of braid to be $\frac{1}{2}$ inch apart, the lowest band parallel to and 3 inches above the end of the sleeve, the lower portion of the disk background to be in the center of the outside half of the sleeve and $\frac{1}{2}$ inch from the upper edge of the upper band (see fig. 5 (2)).

c. *Chevrons to denote grade* (see fig. 5 (4)). --Chevrons to denote grade of enlisted men will be worn on all coats, the field jacket, the shirt when worn without the coat, and on work clothing. They will be worn on the outer half of both sleeves, points up, midway between the elbow and the top of the sleeve.

d. *Chevrons to denote wounds or oversea service in first World War* (see fig. 5 (4)).

(1) Wound chevrons are worn only by those officers, Army nurses, warrant officers, flight officers, and enlisted men who have been authorized to do so. They are to denote wounds received in the first World War only (see AR 600-95).

(2) War service chevrons are worn only by those officers, Army nurses, warrant officers, flight officers, and enlisted men for service in the first World War whose record of service shows them to be entitled thereto.

(3) Wound and war service chevrons are worn on the service coat only, wound chevrons on the right sleeve and war service chevrons on the left sleeve. They are worn points down in the center of the outside half of the sleeve, the point of the lowest chevron to be 1 inch above the cuff braid for officers and former officers, and 4 inches from the end of the sleeve for Army nurses, warrant officers, and enlisted men except that when war service chevrons are worn with service stripes, the war service chevrons will begin $\frac{1}{2}$ inch above the uppermost service stripe. When more than one chevron is worn, the space between chevrons will be $\frac{5}{16}$ inch.

e. *Stripes, service* (see fig. 5 (4)). --All enlisted men of the Army, National Guard, or Organized Reserves who have served honorably in the Federal service as enlisted men in the Army, Navy, or Marine Corps for a period of 3 years, continuously or otherwise (or who have served honorably in the National Guard in Federal service), will wear, as a mark of distinction, the appropriate service stripe.

This stripe will be worn on the outside half of the left sleeve of the service coat, placed at an angle of 45°, the lower end being toward the inside seam of the sleeve and placed 4 inches from the end of the sleeve. For each additional period of 3 years another service stripe will be worn above and parallel to the first stripe, with ¼-inch space between stripes, the space being formed of the background.

e. Stripes, service (see fig. 5 (4)). --All enlisted men of the Army, National Guard, or Organized Reserves who have served honorably in active Federal service as enlisted men in the Army, Navy, or Marine Corps for a period of 3 years, continuously or otherwise (or who have served honorably in the National Guard in Federal service), will wear, as a mark of distinction, the appropriate service stripe. This stripe will be worn on the outside half of the left sleeve of the service coat, placed at an angle of 45°, the lower end being toward the inside seam of the sleeve and placed 4 inches from the end of the sleeve. For each additional period of 3 years another service stripe will be worn above and parallel to the first stripe, with ¼-inch space between stripes, the space being formed of the background.

f. Band of forest green braid (see fig. 5 (5)). --Warrant officers, flight offers, and enlisted men who served on active duty as commissioned officers in the Army of the United States during the first World War, and whose commissioned service was terminated honorably, are authorized to wear a band of forest green braid, ½ inch wide, around both sleeves of the service coat and of the short overcoat, the lower edge of the braid to be 3 inches from the end of the sleeve. The fact of such honorable service must be established by the claimant to the satisfaction of his commander.

f. Band of forest green braid (see fig. 5 (5)). --Warrant officers, flight officers, and enlisted men who served on active duty as commissioned officers in the Army of the United States during World War I or World War II, and whose commissioned service was terminated honorably, are authorized to wear a band of forest green braid, ½ inch wide, around both sleeves of the service coat and of the short overcoat, the lower edge of the braid to be 3 inches from the end of the sleeve. The fact of such honorable service must be established by the claimant to the satisfaction of his commander.

[AG 421 (2 Jan 45) (17 Jan 45)]

56. Insignia, shoulder sleeve. --*a.* Shoulder sleeve insignia are authorized for wear by personnel of units definitely assigned to one of the following groups:

- (1) GHQ Reserve troops (one for all units assigned to GHQ Reserve).
- (2) Headquarters, Army Ground Forces, and its organizations not assigned to one of the groups listed in this paragraph (one for all units).
- (3) Army Air Forces.
 - (a) One for each air force.
 - (b) One for all other Army Air Forces personnel.
- (4) Headquarters, Army Service Forces, and its organizations not assigned to one of the groups listed in this paragraph (one for all units).
- (5) Armies (one for each army).
- (6) Corps (one for each corps).
- (7) Headquarters, Armored Center, and its organizations not assigned to one of the groups listed in this paragraph. (one for all units).
- (7) Armored units (including headquarters, centers, schools, boards, groups, separate battalions, and separate companies) which are not an organic part of a division (one for all units).
- (8) Divisions (one for each division).
- (9) Base commands.
- (10) Defense commands (one for each defense command).
- (11) Service commands (one for each service command).
- (12) Departments (territorial) (one for each department).
- (13) Military district of Washington.
- (14) Antiaircraft artillery commands (one for each command).
- (14) Antiaircraft artillery units (including headquarters, commands, centers, schools, boards, brigades, groups, regiments, separate battalions, separate batteries, and separate platoons) which are not an organic part of a division:
 - (a) One for all units except as provided for in (b) below.
 - (b) One for each antiaircraft command and units thereof not assigned to Army Ground Forces.
- (15) Amphibian commands (one for each command).
- (15) Amphibian units (one for all units).
- (16) Tank Destroyer units (including center, board, replacement center, and battalions) (one for all units).
- (17) Ports of embarkation (one for all ports).
- (18) Students in Army Specialized Training Program (one for all units).
- (19) Replacement and School Command, Army Ground Forces.
- (20) Airborne units (including headquarters centers, schools, boards, brigades, regiments, groups, separate battalions, and separate companies) not an organic part of a division (one for all units).
- (21) Table of Organization units of the Army Service Forces in preparation for extended field service (one for all units). [A. G. 421 (22 May 44.) (C 1, 11 Aug 44.)]

b. Shoulder sleeve insignia are not authorized for wear by trainees at replacement training centers.

c. Shoulder sleeve insignia will be worn on the upper part of the outer half of the left sleeves of the service coat, overcoat, mackinaw, field jacket, and the shirt when worn as an outer garment, the top of the insignia to be ½ inch below top of shoulder seam.

d. Members of airborne units will wear the airbometab immediately above the shoulder sleeve

insignia of the airborne unit.

e. Members of mountain units will wear the mountain tab immediately above the shoulder sleeve insignia of the division. [AG 421 (3 Nov 44)]

(1) Members of designated Army Air Forces commands will wear an arc tab immediately above the shoulder sleeve insignia of the Army Air Forces.

[AG 421 (17 Jan 45)] (C 4, 28 Jul 45.)

f. Personnel returned from overseas for assignment in the United States are authorized to wear the shoulder sleeve insignia of the unit to which they were assigned overseas until they are permanently assigned to another unit at which time the shoulder sleeve insignia of the new unit will be worn on the left shoulder sleeve in accordance with the provisions of c above. The shoulder sleeve insignia of the overseas unit may be worn (but not required) in the same relative position on the right shoulder sleeve. Individuals may select the particular unit shoulder sleeve insignia they desire to wear from those authorized the organizations to which they were assigned while serving overseas. Under no circumstances will more than one such insignia be worn on the right shoulder sleeve at a time.

[AG 421 (22 Jan 45) (14 Feb 45)]

f. Insignia, former units.

(1) Personnel on **duty overseas** or returned from overseas for **reassignment** in the United States are authorized to wear the shoulder sleeve insignia of a unit to which they were assigned overseas until they are permanently assigned to another unit, at which time the shoulder sleeve insignia of the new unit will be worn on the left shoulder sleeve in accordance with the provisions of c above. Such individuals are authorized (but not required) to wear on the right shoulder sleeve, in the same relative position, the shoulder sleeve insignia of an organization to which they were assigned while serving overseas. If such an individual is assigned to a unit not authorized a shoulder sleeve insignia, none will be worn on the left shoulder sleeve except as indicated in (2) below.

(2) Personnel earmarked for separation whether overseas or in the United States, when assigned to another unit as a means to accomplish their separation, are authorized to wear on their left shoulder sleeve, the shoulder sleeve insignia of an organization to which they were assigned while serving overseas.

(3) The provisions of (1) and (2) above apply only to the wearing of shoulder sleeve insignia by individuals assigned to United States Army units during the present war. Under no circumstances will more than one insignia be worn on either shoulder sleeve nor will the same insignia be worn on both shoulder sleeves at the same time. [AG 421 (24 Oct 45)]

57. Insignia, aviation cadets and enlisted aviation students (see fig. 5 (3)). --Aviation cadets and enlisted men eligible for appointment as aviation cadets who are detailed as aviation students will wear the prescribed insignia centered on the outside of the right sleeve of the coat, overcoat, and the shirt when worn without the coat, with the lowest point 4 inches above the lower edge.

57. Insignia, aviation cadets and enlisted aviation students (see fig. 5 (3)). --Aviation cadets and enlisted men eligible for appointment as aviation cadets who are detailed as aviation students will wear the prescribed insignia centered on the outside of the right sleeve of the coat, overcoat, **field jacket and the shirt when worn without the coat**, with the lowest point 4 inches above the lower edge. [A. G. 421 (22 May 44.)] (C 1, 11 Aug 44.)

58. Insignia, Army Air Forces technical specialists (see fig. 5 (6)). --Insignia of Army Air Forces technical specialists will be worn centered on the outside of the right sleeve of the service coat, shirt when worn without the coat, and work clothing with the lowest point 4 inches above the lower edge.

59. Insignia to denote excellence of organizations in the Coast Artillery Corps. --Officers and enlisted men belonging to batteries of the Coast Artillery Corps which have been classified for the year by the appropriate commander as "excellent" in service target practice will wear the insignia indicating such classification on the middle line of the outside of the cuff of the right sleeve of the service coat, 2 inches from the bottom edge of the sleeve, except during such time as the commanding officer shall authorize the wearing of the service shirt without the service coat, when the insignia will be worn centered on the left pocket of the shirt.

60. Insignia, flying instructors. --Insignia of flying instructors will be worn on the outside half of the right sleeve of the service coat, and shirt when worn without the coat, 4 inches from the end of the sleeve.

61. Insignia of students, officer candidate schools. --Warrant officers and enlisted men while students at officers' candidate schools will wear the prescribed insignia centered on the outside of the right sleeve of the service coat and overcoat with the lowest point 4 inches above the lower edge. When the shirt is worn without the coat, the insignia will be worn centered on the left pocket of the shirt.

62. Insignia, bomb disposal personnel. --Bomb disposal personnel insignia is authorized for wear by all bomb disposal personnel, including ordnance bomb disposal schools all ordnance bomb disposal companies, during the period detailed or assigned to duty in connection with bomb disposal activities. The insignia will be worn centered on the left pocket of the shirt when worn without the coat and centered on the outside right sleeve of the service coat and overcoat, with the lowest point 4 inches above the lower edge.

63. Insignia to denote excellence of students, Army Specialized Training Program. --Enlisted men who have been designated for scholastic excellence as trainees in the Army Specialized Training Program will wear the insignia to denote excellence, only during the term following that in which it was earned. If not redesignated as excellent, the insignia will be removed from the uniform. The insignia will be worn on the outside left sleeve of the service coat and overcoat, with the lowest point

4 inches above the lower edge.

64. Brassards. --*a. General Staff Corps*. --In time of war the prescribed brassard will be worn around the left sleeve above the elbow by officers of the General Staff Corps in the theater of operations at all times except when visiting the front line, unless otherwise prescribed, and in the zone of the interior only when on inspection duty or attending ceremonies.

b. Miscellaneous. --The prescribed brassard will be worn on the left sleeve above the elbow (see fig. 6) by each of the following-named classes:

- (1) Military police, as prescribed by the commanding officer.
- (2) In time of war with a signatory of the Geneva Convention, while on duty in the theater of operation, all persons in the military service rendered neutral by the terms of said convention.
- (3) Enlisted men on recruiting duty, while on duty.
- (4) Members of fire-truck and hose companies.
- (5) Post officers.
- (6) Members of veterinary service assigned to theater of operations.
- (7) Newspaper correspondents, photographers, and commentators, their chauffeurs and messengers while attached to and authorized to accompany forces of the Army of the United States in the theater of operations.
- (8) Trainees acting as noncommissioned officers at replacement training centers.
- (9) Such other personnel for whom brassards are authorized in AR 600-35 will wear the appropriate brassard when prescribed.

65. Emblem, sleeve, combatant, and emblem, sleeve, noncombatant (see fig. 6). --The prescribed emblem will be worn attached permanently to the left sleeve of the outer garment, midway between the elbow and the shoulder, by civilian employees in forces of the Army of the United States, having a status recognized by the War Department as part of the forces, and by civilian personnel of all United States military missions in theaters of operations and in oversea garrisons.

65. Emblem, sleeve, combatant, and emblem, sleeve, noncombatant (see fig. 6). --Rescinded.
[AG 421 (6 Nov 44)]

66. Detailed and detached officers and enlisted men. --*a.* Officers detailed in an arm or service in which they do not hold permanent commissions will wear the insignia of the arm or service in which they are detailed, except that officers appointed in the Army of the United States will be governed by the provisions of paragraph 49.

b. Officers and enlisted men under the jurisdiction of the National Guard Bureau, including--

- (1) Officers on duty in the office of the Chief of the National Guard Bureau,
- (2) Officers in charge of National Guard affairs at service command headquarters, and
- (3) All instructors detailed with the National Guard under the provisions of the National Defense

Act, as amended, except those detailed for temporary duty during field training, will wear the insignia of the National Guard Bureau.

c. Retired officers. --Retired Regular Army officers on active duty will wear the insignia of the arm or service in which commissioned at time of retirement except when detailed in another arm or service, in which event they will wear the insignia of the arm or service in which detailed.

67. Distinctive insignia and trimmings. --*a.* Subject to the approval of the War Department in each case, organizations classified in general as regiments, separate battalions, or separate companies are authorized to adopt distinctive insignia or trimmings for wear by members thereof as a part of the uniform as a means of promoting esprit de corps. Installations of service command units and War Department overhead are included in the general classification of organizations authorized to adopt distinctive insignia or trimmings. Members of the inactive National Guard are permitted to wear the distinctive insignia or trimmings of an organization to which assigned by proper authorities. Distinctive insignia should bear the organization badge or coat of arms, or similar device, having historical significance connected with the organization, such as the ornament of the organization when originally organized, or that worn in some prior war. If trimmings are adopted, the color should have some historical significance connected with the organization. Colored trimmings will not be worn with the cotton service uniform.

b. When insignia or trimmings other than those indicated above are desired, the reason for variation must be made plain when the approval of the War Department is requested.

c. If distinctive insignia or trimmings are adopted, they must be worn by the entire personnel of the organization, and unit funds or Army exchange funds must provide each newly joined or reenlisted enlisted man one complete set of such distinctive insignia and trimmings without cost to the enlisted man, as public funds are not available for this purpose. Expenditure of unit or Army exchange funds for this purpose is authorized. Distinctive insignia and trimmings will not be adopted where conditions preclude their issue to enlisted men from purchases made by unit or Army exchange funds.

c. If distinctive insignia or trimmings are adopted, they must be worn by the entire personnel of the organization, and unit funds must provide each newly joined or reenlisted man one complete set of such distinctive insignia and trimmings without cost to the enlisted man, as public funds are not available for this purpose. Expenditure of unit funds for this purpose is authorized. Distinctive insignia and trimmings will not be adopted where conditions preclude their issue to enlisted men from purchases made by unit funds. [AG 421 (15 Jun 45)] (C 4, 28 Jul 45.)

d. When distinctive insignia is approved or authorized by the War Department, it will be worn--

- (1) *By officers, warrant officers, and flight officers.*
 - (a) On the service coat, centered on the shoulder loops (see fig. 4).

- (b) On the service hat midway between band and eyelet (see fig. 1 (4)).
- (2) *By enlisted personnel.*
 - (a) On the service coat on both sides of the lapel, upper edge of insignia $\frac{3}{4}$ inch below notch of lapel on the prolongation of a line through the center of the button insignia parallel to inner line of collar and lapel (see fig. 2 (2)).
 - (b) On the garrison cap $1\frac{1}{2}$ inches to the left of the front center and centered on the curtain (see fig. 1 (5)).
 - (c) On the service hat midway between band and eyelet (see fig. 1 (4)).
- e. Distinctive insignia or trimmings will not be approved or manufactured for the duration of the present war.

SECTION V

DECORATIONS, SERVICE MEDALS, ETC.

	Paragraph
Decorations, service medals and badges; when worn _____	68
Decorations and service medals, how worn _____	69
Badges, how worn _____	70
Foreign decorations, service medals, etc _____	71
Fourragere _____	72
Service ribbons, service stars, and miniatures _____	73
Lapel buttons _____	74
War Department General Staff identification _____	75

68. Decorations, service medals, and badges; when worn.
- a. (1) Decorations, service medals, and badges may be worn on the service coat or on the shirt when not equipped for combat or simulated combat. Only aviation, parachutists, glider, and Combat and Expert Infantryman badges may be worn when equipped for combat or simulated combat.
 - (2) Decorations, service medals, and badges will not be worn on the overcoat.
 - (3) *Distinguished unit badge.*
 - (a) When a unit has been awarded a citation streamer, a distinguished unit badge identifying such citation shall be issued to all individuals who are assigned or attached as members of such unit, to become a part of the uniform as follows:
 1. Individuals who are assigned or attached to the unit on the occasion for which citation was awarded are entitled to wear the Distinguished Unit Badge as a permanent part of the uniform. Such individuals who are no longer with the unit will be reported through channels to The Adjutant General. Each successive headquarters through which such reports are forwarded will issue badges and take such other action as is necessary with respect to personnel under its jurisdiction, indicating on the report the action taken in each case.
 2. Individuals who are subsequently assigned or attached to a unit which has earned the citation, and only so long as they remain with the unit, are entitled to wear the Distinguished Unit Badge as a temporary part of the uniform.
 - (b) Individuals authorized to wear the Distinguished Unit Badge, either as a permanent or temporary part of the uniform, may add a bronze Oak-Leaf Cluster as follows:
 1. Oak-Leaf Cluster may be added permanently for each time the unit to which they belong is again cited, and/or if transferred to a new unit, this unit is cited for the first time.
 2. Oak-Leaf Cluster may be added temporarily for each time the unit has been cited prior to becoming assigned or attached.
 3. When more than five Oak-Leaf Clusters have been earned, silver Oak-Leaf Clusters are authorized for wear in the ratio of one to five.
 - (4) Officers suspended from either rank or command, and enlisted men serving sentence of confinement, are prohibited from wearing decorations, medals, or substitutes therefor.
 - b. Decorations and service medals will be worn when in uniform except as in *a* above on the following occasions, unless especially prescribed otherwise:
 - (1) On state occasions at home and abroad.
 - (2) When receiving or calling upon, or acting as escort or aide to, the President of the United States, the sovereign or chief executive of any foreign country, or any member of a reigning royal family.
 - (3) At all official and social functions at the White House and when attending elsewhere other ceremonies and social functions given by or for members of the Cabinet, General of the Armies, Chief of Staff, a former Chief of Staff, or an army, base command, defense command, service command or officer of a higher grade.
 - (4) At escort of the color.

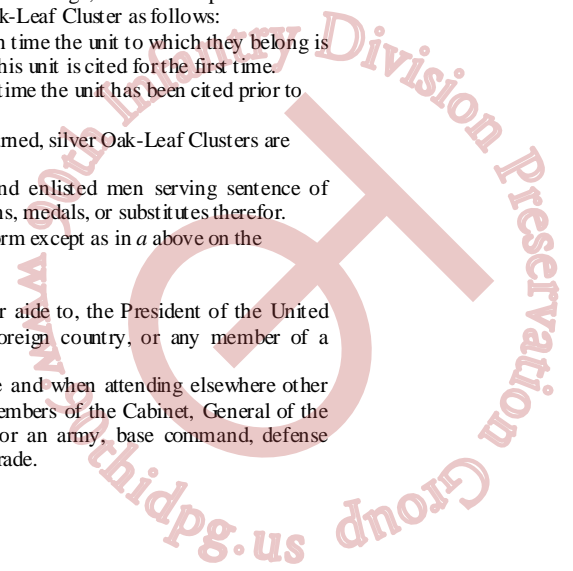

c. Decorations and service medals may be prescribed by the commanding officer for wear except as in *a* above on the following occasions, when in uniform:

- (1) For parades, reviews, inspections, and funerals.
- (2) On ceremonial and social occasions of a general and formal nature.

d. Decorations and service medals may be worn when in uniform, except as in *a* above, at the option of the wearer, on social occasions of a private nature and on holidays when not on duty with troops under arms.

e. When decorations and service medals are worn under the provisions of *b*, *c*, and *d* above, all those to which the wearer is entitled will be worn by persons in formation; persons not in formation, including reviewing and inspecting officers and their staffs, may omit the wearing of some for the purpose of especially emphasizing or giving especial honor to those which they individually consider particularly appropriate to the occasion.

f. Decorations, medals, and badges presented by an authority of inferior jurisdiction to the United States Government will not be worn on the uniform, except that those awarded in accordance with State laws and regulations may be worn by members of the National Guard when they are not in the active military service of the United States.

g. Badges of societies will be worn on the uniform only when attending meetings, ceremonies, and functions of such societies, and they may then be worn with decorations, service medals, or substitutes therefor.

h. The wearing of decorations, service medals, or miniatures on civilian clothes should be limited to ceremonial occasions; and then only when strictly appropriate to the occasion.

i. Nothing in these regulations will be construed as affecting the privilege of civilians who are entitled in their own right to decorations, service medals, and badges, to wear on all appropriate occasions such decorations, service medals, and badges, with civilian clothes of any kind, nor to restrict the method of wearing to that prescribed in these regulations.

j. *Unauthorized wearing of decorations, service medals, badges, service ribbons, insignia, lapel buttons, etc.* --See AR 600-90. Next of kin are not authorized to wear decorations, etc.

69. Decorations, service medals, and badges; how worn. --*a*. The *Medal of Honor* is worn pendant from the ribbon placed around the neck outside the shirt collar and inside the coat collar, the medal proper hanging over the necktie near the collar.

b. *Distinguished Service Cross (Army), Navy Cross (Navy), Distinguished-Service Medal (Army), Distinguished-Service Medal (Navy), Legion of Merit, Silver Star, Distinguished Flying Cross, Soldier's Medal (Army), Navy and Marine Corps Medal, Bronze Star, Air Medal, Purple Heart, Gold Life-Saving Medal (Treasury Department), Silver Life-Saving Medal (Treasury Department), Good Conduct Medal (Army), Good Conduct Medal (Navy, Marine Corps, or Coast Guard)*, in that order of precedence followed by service medals in order of the date of the service performed, will be worn on the left breast in order from right to left of the wearer about 4 inches below the middle point of the top of the shoulder, in one or more lines (see fig. 8 (1)). When more than one line is worn, the lines will overlap.

b. *Distinguished-Service Cross (Army), Navy Cross (Navy), Distinguished-Service Medal (Army), Distinguished-Service Medal (Navy), Legion of Merit, Silver Star, Distinguished Flying Cross, Soldier's Medal (Army), Navy and Marine Corps Medal, Bronze Star Medal, Air Medal, Purple Heart, Gold Life-Saving Medal (Treasury Department), Silver Life-Saving Medal (Treasury Department), United States of America Typhus Commission Medal, Good Conduct Medal (Army), Good Conduct Medal (Navy, Marine Corps, or Coast Guard)*, in that order of precedence followed by service medals in order of the date of the service performed, will be worn on the left breast in order from right to left of the wearer about 4 inches below the middle point of the top of the shoulder, in one or more lines (see fig. 8 (1)). When more than one line is worn, the lines will overlap. [AG 421 (10 May 45)] (C 4, 28 Jul 45.)

c. The *Distinguished Unit Badge (Army)* will be worn on the right breast centered immediately above the pocket (see fig. 8 (9)).

d. The *Presidential Unit Citation (Navy)* will be worn in the manner prescribed in *c* above. If the *Distinguished Unit Badge (Army)* and the *Presidential Unit Citation (Navy)* both have been awarded, the *Distinguished Unit Badge* will be worn on the right.

e. *Oak-leaf clusters* will be placed on the suspension ribbon of the appropriate decoration. Silver Oak-Leaf Clusters are authorized in lieu of bronze Oak-Leaf Clusters in the ratio of one to five, and are worn above or to the right of bronze Oak-Leaf Clusters (see fig. 8 (3)).

f. *Clasps* will be worn on the ribbon of the service medal in order of the date of the service performed, beginning at the top, with a space of $\frac{1}{8}$ inch between adjacent clasps (see fig. 8 (4)).

70. Badges, how worn. --Badges are worn on the left breast, aviation, parachutists, and Combat and Expert Infantryman badges are worn above the line of medals or service ribbons, other badges below that line (see fig. 8 (5)). Aviation badges earned by Army personnel while serving in the United States Navy, Marine Corps, and Coast Guard are worn immediately above the upper right pocket of the service coat and immediately above the right pocket of the service shirt when worn as an outer garment. Substitutes are not authorized to be worn in lieu of badges. There is no order of precedence for badges.

70. Badges, how worn. --Badges are worn on the left breast, aviation, parachutists, and Combat and Expert Infantryman badges are worn above the line of medals or service ribbons, other badges below that line (see fig. 8 (5)). Aviation badges earned by Army personnel while serving in the United States Navy, Marine Corps, and Coast Guard are worn immediately above the upper right pocket of the

service coat and immediately above the right pocket of the service shirt when worn as an outer garment. **Except for aviation badges described in paragraph 72b to p, inclusive, AR 600-35, substitutes are not authorized to be worn in lieu of badges. Miniature aviation badges are authorized for optional wear on the service shirt when worn as an outer garment.** There is no order of precedence for badges. [A. G. 421 (3 Jun 44.) (C 1, 11 Aug 44.)]

70. Badges, how worn. --Badges are worn on the left breast, aviation, parachutists, and Combat and Expert Infantryman badges are worn above the line of medals or service ribbons, other badges below that line (see fig. 8 (5)). Aviation badges earned by Army personnel while serving in the United States Navy, Marine Corps, and Coast Guard are worn immediately above the right pocket of the service shirt when worn as an outer garment. Except for aviation badges described in paragraph 72b to p, inclusive, AR 600-35, substitutes are not authorized to be worn in lieu of badges. Miniature aviation badges are authorized for optional wear on the service shirt when worn as an outer garment. There is no order of precedence for badges.

70. Badges, how worn. --*a. General.* --Badges will be worn on the left breast. Not more than one of the aviation, parachutist's, glider, medical, combat or expert infantryman badges will be worn above the line of medals or service ribbons at any one time. The individual may select the badge he desires to wear from among those to which he is entitled except--

- (1) The combat or expert infantryman badge will not be worn by those assigned to the Medical Department, other than attachment to a detachment of patients, during the period of such assignment, or Corps of Chaplains, or while in a flying-pay status. The right to wear one of these badges is restored upon relief from the above restriction.
- (2) The medical badge will not be worn temporarily by individuals in an active theater of operations when transferred or assigned outside the Medical Department to duties which would bring them in contact with the enemy. The right to wear this badge is restored upon relief from combat duties or on reassignment to the Medical Department.

Other badges will only be worn below the line of medals or service ribbons (see fig. 8 (5)). No badges authorized to be worn above the medal or ribbons will be worn below that line except that personnel awarded the combat infantryman badge or the medical badge and also the parachutist's or glider badge may wear either the combat infantryman badge or the medical badge but not both above the line of medals or service ribbons and either the parachutist's or glider badge but not both below the line of ribbons. Aviation badges earned by Army personnel while serving in the United States Navy, Marine Corps, and Coast Guard are worn immediately above the right pocket of the service shirt when worn as an outer garment. Except for aviation badges described in paragraph 72b to p, inclusive, AR 600-35, **and combat and expert infantryman badges**, substitutes are not authorized to be worn in lieu of badges. Miniature aviation **and combat and expert infantryman** badges are authorized for optional wear on the service shirt when worn as an outer garment. There is no order of precedence for badges. [AG 421 (5Apr 45) (20 Aug 45)] (C 4, 28 Jul 45.)

a. b. Badges for marksmanship, gunnery, bombing, etc. (see fig. 8 (6)).

(1) *Badges for qualification in the use of arms.*

(a) *General.* --For any one weapon, only the badge for the qualification held at the time will be worn. For the designation of authorized weapons see AR 600-35. No more than one basic badge (AR 600-35) of any one class, for example, marksman, pistol marksman, etc., will be worn. Requalification, or qualification in the same class with more than one weapon, will be indicated by appropriate bars (AR 600-35), which will be worn attached to the basic badge.

(b) *Period during which badges may be worn.*

1. *Enlisted men.* --Badges attained by individual enlisted men as a result of qualification in weapons designated as their principal arm may be worn from the date the qualification or requalification is announced in orders until their next opportunity to requalify. Badges attained in weapons other than those designated as their principal arm may be worn during the period of current enlistment or until they are again tested for qualification.

2. *Officers.* --Officers may wear the badge of last qualification.

- (2) *Badges for distinguished designations.*
- (3) *Army team and corps area team marksmanship badges.*
- (4) *Army Air Forces technician badge.*
- (5) *Driver and mechanic award badge.*
- (6) *Marine divers badge.* See AR 775-50 for qualifications.

b. c. Aviation badges (see fig 8 (5)). Eligibility to wear Army aviation badges will be prescribed by the Commanding General, Army Air Forces.

c. d. Miscellaneous badges. --Those recognized by the War Department for wear are--

- (1) Corps and division badges of the Civil and Spanish-American Wars, and badges of the shoulder sleeve insignia of the World War, worn in the form of pins or lapel buttons.
- (1) Corps and division badges of the Civil and Spanish-American Wars, and badges of the shoulder sleeve insignia of **United States Army units in any war** worn in the form of pins or lapel buttons. [AG 421 (11 Dec 44) (29 Dec 44)]
- (2) Badges of military societies commemorative of the wars of the United States.
- (3) Badges of the Regular Army and Navy Union, and of the Army and Navy Union of the United States.
- (4) Badges of honor rifle teams of arms or services authorized to establish and maintain such

teams and badges pertaining to the national matches, as defined in section 113, of the National Defense Act as amended by the act of May 28, 1928 (45 Stat. 786; 32 U. S. C. 181b; M. L., 1939, sec. 1251).

71. Foreign decorations, service medals, etc. --*a.* A person who has received a decoration from the government of a foreign country will wear the decoration as a courtesy to that country when attending any public function in that country or when attending any formal function in any country, in the house of, or in honor of a public official or other distinguished citizen or subject of the country whose decoration he possesses, and on such occasions the foreign decoration, if a breast decoration, will take precedence over all other foreign breast decorations. If the foreign decoration is a neck decoration, it will be worn above all other foreign neck decorations, but below the Medal of Honor. Decorations, medals and service ribbons presented by the government of a foreign country with which the United States is at war will not be worn for the duration of such war.

b. Except as prescribed above, the wearing of foreign decorations or service medals and the corresponding service ribbons is optional. They may be worn on the occasions prescribed for American decorations and service medals, or service ribbons, respectively, and when worn will be placed to the left of all American decorations and service medals in order of date of receipt except that when one person possesses two or more decorations from the same foreign country, the order of precedence of those particular decorations will be determined by the rules of the country concerned. A person who does not possess the Medal of Honor, but who has a foreign decoration, which, under the rules of the country concerned, is required to be worn suspended from the neck, will wear it in the manner prescribed for the Medal of Honor (par. 69*a*). A foreign decoration or foreign service medal will not be worn alone; at least one American decoration or American service medal (or its miniature if in evening clothes) must be worn with a foreign award, except when awarded under the provisions of *c* below.

c. Decorations, medals, badges, and wound chevrons or stripes awarded by any country associated with the United States in the first World War or the present war for service as a member of the military forces of such country in the first World War or the present war may be worn at such times as the corresponding American decorations, medals, badges, and wound chevrons or stripes are worn under these regulations. Foreign aviation badges are worn immediately above the upper right pocket of the service coat and immediately above the right pocket of the service shirt when worn as an outer garment and immediately above the Distinguished Unit Badge. When either a United States Navy, Marine Corps, or Coast Guard aviation badge is worn with a foreign aviation badge, the United States badge will be worn above the foreign.

d. As far as may be consistent with the foregoing, foreign decorations and medals will be worn as nearly as practicable in accordance with the regulations of the country concerned.

e. The authority and procedure for acceptance of foreign decoration and service medals are prescribed in AR 600-45.

72. Fourragere (see fig. 8 (7)). --*a.* The fourragere awarded by the French Government during the first World War is both an organizational and an individual decoration.

(1) As an organizational decoration it will be worn on appropriate occasions by all members of an organization on which the decoration has been conferred. But this right to wear the decoration ceases with the termination of membership in such an organization unless an individual is entitled to the decoration in his own right as prescribed in (2) below.

(2) The fourragere is an individual decoration in the case of individuals who have received the requisite number of citations for this decoration, and such individuals have the same rights and privileges with respect to this decoration as pertain to other individual decorations. The citation of an organization for the fourragere extends to all members of the organization who were present on any occasion for which it was cited, and in determining the right of an individual to the fourragere as an individual decoration all such citations in whatever organization received will be counted. The fourragere will be worn as an individual decoration only by those who have received official notification from The Adjutant General that they are authorized to wear the decoration. When worn by an individual as an individual decoration, the fourragere will bear a distinctive mark as prescribed in AR 600-35, showing the designation of the organization of which he was a member when he received his last citation.

b. It is attached to the left shoulder by fastening the buttonhole thereof to the left shoulder-loop button, under the shoulder loop, passing the fourragere under the left arm, and attaching the loop on the ferret end to the shoulder-loop button, allowing the ferret to hang down in front.

73. Service ribbons, service stars, and miniatures. --*a.* *Service ribbons* (see fig. 8 (6)).

(1) Service ribbons may be worn on the service coat and on the shirt. They will not be worn on the overcoat nor on civilian clothes.

(2) Service ribbons may be either sewed in place or attached by means of a bar. Beginning with the Medal of Honor ribbon, service ribbons will be worn in the same order and position as prescribed for the decorations and service medals. If more than one line is necessary, succeeding lines will be placed below and parallel to the first line, with a space of $\frac{1}{8}$ inch between lines. When decorations or medals are worn, the service ribbons will be removed if on a bar; if sewed on the coat, the decoration and medals will be so placed as to exclude the service ribbons from view.

(3) The announcement in War Department general orders or in War Department document titled "Decorations United States Army," or in orders of the headquarters of any commander

authorized to make awards of decorations, of the award of any decoration will be considered as granting to the individual named therein authority to wear the service ribbon of the decoration so awarded pending the actual presentation of the decoration itself.

- (4) American service ribbons are authorized to be worn only for decorations and service medals issued by the War, Navy, and Treasury Departments and the War Shipping Administration.
- (5) Not more than one service ribbon of any decoration or service medal will be worn on the uniform.

b. Service stars (see fig. 8 (4)). --

- (1) Bronze service stars are worn on the service ribbon of the Victory Medal to indicate possession of the battle clasps referred to in paragraph 66b (1) to (14), inclusive, AR 600-35, a star for each clasp.
- (2) A bronze service star is worn on the service ribbon of the American Defense Service Medal to indicate possession of the Foreign Service clasp authorized for service outside the continental United States at any time during the period for which the medal is awarded. Not more than one star is authorized.
- (3) Bronze service stars are worn on the service ribbon of campaign medals for the current war to indicate credit for battle participation, a star for each battle or campaign for which credit is awarded. Silver service stars are authorized in lieu of bronze service stars in the ratio of one to five, and will be placed to the right of bronze service stars.

c. Miniatures.

- (1) Miniatures of the decorations, service medals, and ribbons are worn attached to a bar or chain on the left lapel of military or civilian evening clothes.
- (2) A miniature oak-leaf cluster will be worn on the appropriate service ribbon for each cluster awarded.

74. Lapel buttons. --*a.* Lapel buttons are optional for wear with civilian clothing only. Those representing decorations and service medals may be worn only by those to whom the decorations and medals to which they correspond shall have been awarded. Those for the Officers' Reserve Corps and the Enlisted Reserve Corps may be worn only by members of those Corps, respectively.

b. Lapel button for service rendered prior to 8 September 1939 (see par. 82e, AR 600-35).

- (1) Persons entitled to wear this lapel button are--
 - (a) Those who have served honorably as enlisted men, field clerks, warrant officers, nurses, or commissioned members of the military forces in time of war.
 - (b) Those who have served honorably in the Army of the United States and have been trained and qualified in the grade of private or in a higher grade, including contract surgeons and veterinarians, warrant officers, nurses, and commissioned officers.
 - (c) Those who have served honorably in a military unit conducted under the War Department, or have been trained and qualified as a private or in a higher grade.
- (2) Next of kin are not authorized to wear the lapel button for service.
- (3) Except where other regulations govern, the length of service and training required for qualification for the lapel button for service will be as follows, such service and training to have been considered honorable and satisfactory by the commanding officer:
 - (a) Two months' service in the Regular Army.
 - (b) One year's service in the National Guard.
 - (c) One year's service in the Enlisted Reserve Corps, including 15 days' training on active or inactive duty, or equivalent training during another year.
 - (d) One year's service in the basic course of a senior Reserve Officers' Training Corps unit, or in a junior Reserve Officers' Training Corps unit in an essentially military school.
 - (e) Two years' service in other junior Reserve Officers' Training Corps units and units given Government aid under section 55c, National Defense Act, and section 1225, Revised Statutes.
 - (f) Two months' service in a citizens' military training camp or its equivalent.

c. Lapel button for service rendered since 8 September 1939 (see par. 82f, AR 600-35).

- (1) Persons entitled to wear this lapel button are--
 - (a) Those who have served honorably in active Federal service in the Army of the United States since 8 September 1939, and who are, or have been, honorably discharged or transferred to an inactive status.
 - (b) Those who have served as officers or enrolled members of the Women's Army Auxiliary Corps, whose separation from the service was under honorable conditions.
- (2) Next of kin are not authorized to wear the lapel button for service.

75. War Department General Staff identification. --*a. By whom worn.* Authorized for optional wear by officers of the Regular Army who, since June 4, 1920, have served not less than 1 year as regular or as additional members of the War Department General Staff; and officers of the civilian components who, since June 4, 1920, have served not less than 1 year as additional members of the War Department General Staff.

57. War Department General Staff identification. --*a. By whom worn.* --Authorized for optional wear, only by officers of the Army of the United States who, since 4 June 1920, have served not less than 1 year as regular or as additional members of the War Department General Staff, provided that from March 1, 1942, and continuing during the present emergency, officers who were detailed in the

War Department General Staff, additional members of the War Department General Staff, and who have received from the War Department a certificate of eligibility to wear the device. Those officers who have heretofore been officially authorized to wear this device may continue to do so.

b. How worn. --On the right side upper pocket of the service coat centered between the point of the flap and the bottom and the sides of the pocket (see fig. 8 (8)).

c. When worn. --Optional for all occasions.

SECTION VI

VARIOUS ARTICLES OF EQUIPMENT

	Paragraph
Pistol _____	76
Belt _____	77
Spurs _____	78
Web field equipment _____	79

76. Pistol. --*a. In the field.* --The pistol (or revolver) with holster and 21 rounds of ammunition will be worn by officers and warrant officers in the field. It will not be worn by chaplains. It will be worn by officers of the Medical Department only when necessary for personal protection.

b. Other occasions when worn.

(1) During their tours of duty, the officer of the day and other personnel, as prescribed by the commanding officer.

(2) Orderlies, as prescribed by the commanding officer.

(3) Adjutants general and adjutants when placing officers in arrest.

77. Belt. --*a. Officers and warrant officers.* --*a.* The web belt, pistol, revolver, or carbine, M-36, will be worn when under arms and on field duty. When the belt and overcoat are worn together, the belt will be worn outside the overcoat.

b. Enlisted men. --The belt, pistol, revolver, or carbine, M-36, or the belt, cartridge, with accoutrements will be worn when under arms and on field duty. When the overcoat and the web cartridge belt are worn together, the belt will be worn outside the overcoat.

78. Spurs. --Spurs will always be worn, with or without stirrup guard, by mounted personnel when duty requires them to be mounted. The spurs will be worn with points down.

79. Web field equipment. --The standardized web equipment for officers consists of the belt, pistol, revolver, or carbine, M-36, and accoutrements, the suspenders, belt, M1936, and the bag, canvas, field, M1936. These articles will be worn as prescribed in FM 21-15.

SECTION VII

MISCELLANEOUS

	Paragraph
Unauthorized combinations _____	80
Civilian decorations, jewelry, etc. _____	81
Discrimination against persons lawfully wearing the uniform _____	82
Wearing, manufacture, or sale of medals and badges _____	83
Distinctive articles of the uniform _____	84

80. Unauthorized combinations. --Combinations of various articles of the uniform other than the combinations prescribed in these regulations and by Tables of Basic Allowances are prohibited.

81. Civilian decorations, jewelry, etc. --No civilian decoration, jewelry, watch chain, etc. will appear exposed on the service uniform.

82. Discrimination against persons lawfully wearing the uniform. --*a.* That hereafter no proprietor, manager, or employee of a theater or other public place of entertainment or amusement in the District of Columbia, or in any Territory, the District of Alaska or Insular possession of the United States, shall make, or cause to be made, any discrimination against any person lawfully wearing the uniform of the Army, Navy, Revenue-Cutter Service or Marine Corps of the United States because of that uniform, and any person making, or causing to be made, such discrimination shall be guilty of a misdemeanor, punishable by a fine not exceeding five hundred dollars, *Act 1 March 1911 (36 Stat. 963; 18 U. S. C. 523; M. L., 1939, sec. 2147).*

b. Similar provisions of law governing in connection with the same subject matter are in force in many of the States of the Union, for information with reference thereto, the statutes of the several States should be consulted.

83. Wearing, manufacture, or sale of medals and badges. --See AR 600-90.

84. Distinctive articles of the uniform. --See paragraph 26*b.*

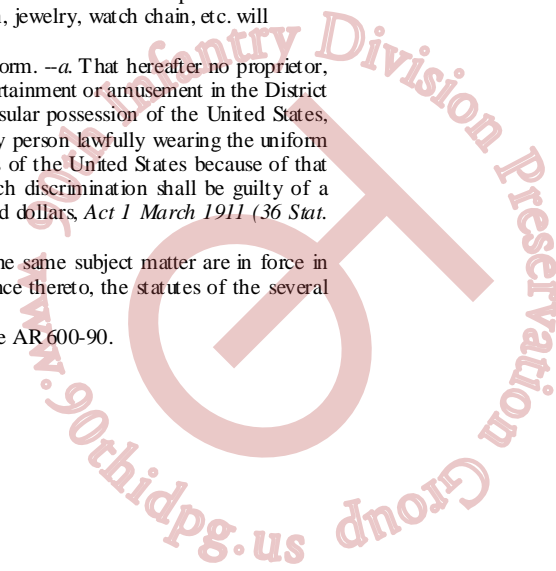

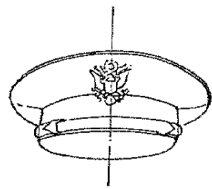

(1) Service cap.

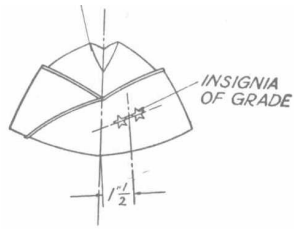

(2) Garrison cap, general officers.

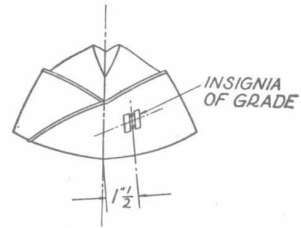

(3) Garrison cap, officers.

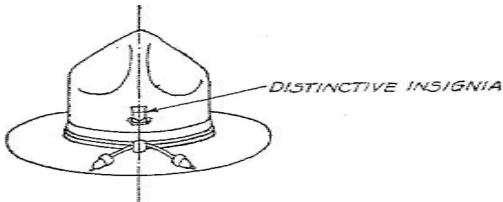

(4) Service hat.

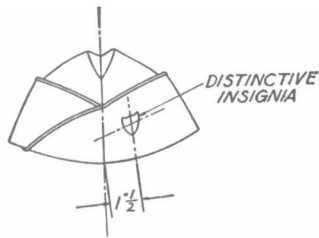

(5) Garrison cap, enlisted men.



(6) Garrison cap, aviation cadets.

FIGURE 1. --Insignia on headgear.

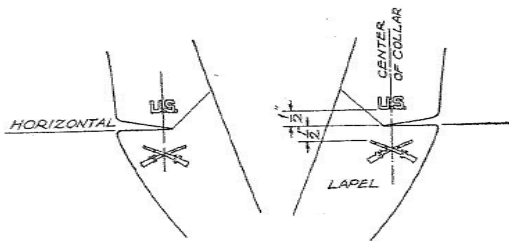

(1) Officers, warrant officers, flight officers, and aviation cadets.

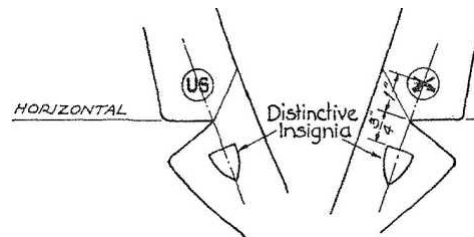

(2) Enlisted men.

FIGURE 2. --Insignia on collar and lapel of service coat.

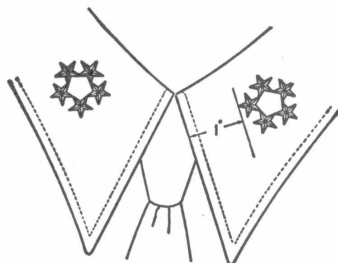

(1) --General of the Army.
[AG 421 (27 Jan 45)]

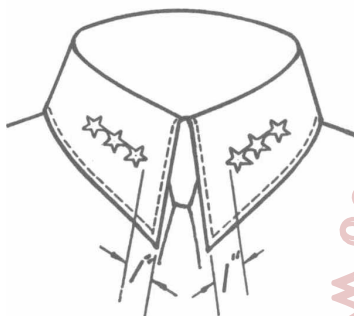

(1)(2) --General officers of the line.

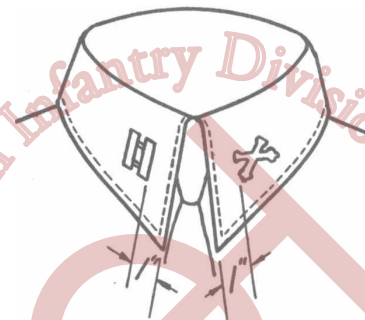

(2)(3) -- Officers, warrant officers, and flight officers.

FIGURE 3. --Insignia on collar of shirt, officers.

www.90thidpg.us
90th Infantry Division
Preservation
Group

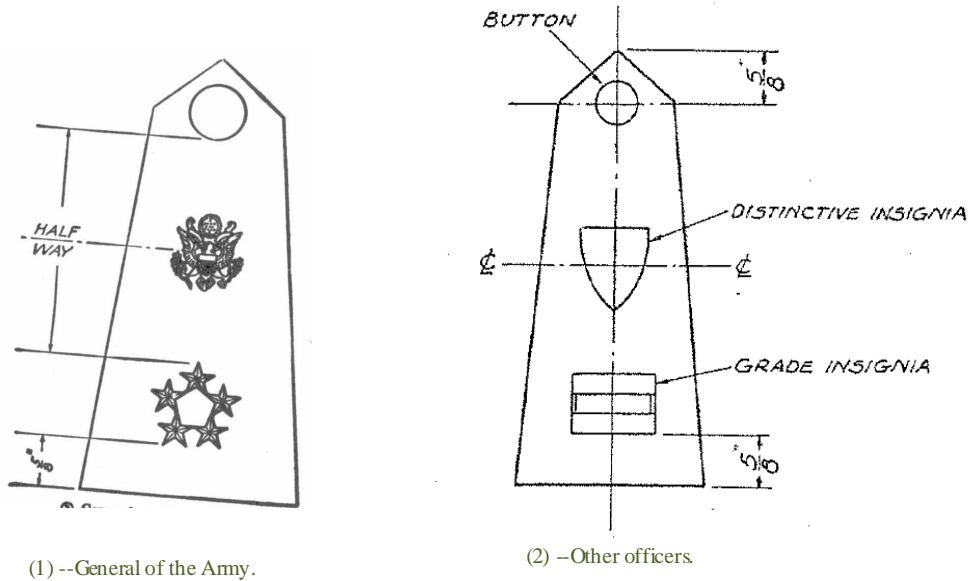

(1) --General of the Army.

(2) --Other officers.

FIGURE 4. --Insignia on shoulder loop, officers.
[AG 421 (27 Jan 45)]

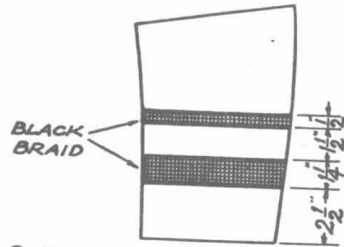

(1) Short overcoat, general officers.

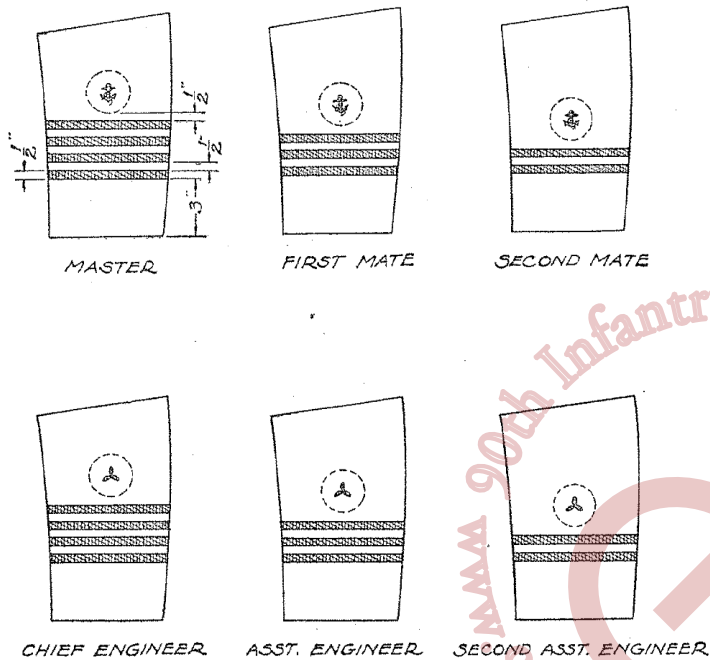

(2) Service coat and overcoat, warrant officers, Army Mine Planter Service.

FIGURE 5. --Insignia on sleeve.

90th Infantry Division Preservation Group
www.90thidpg.us

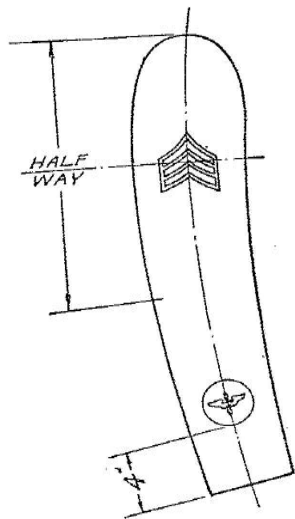

(3) Service coat, aviation cadets.

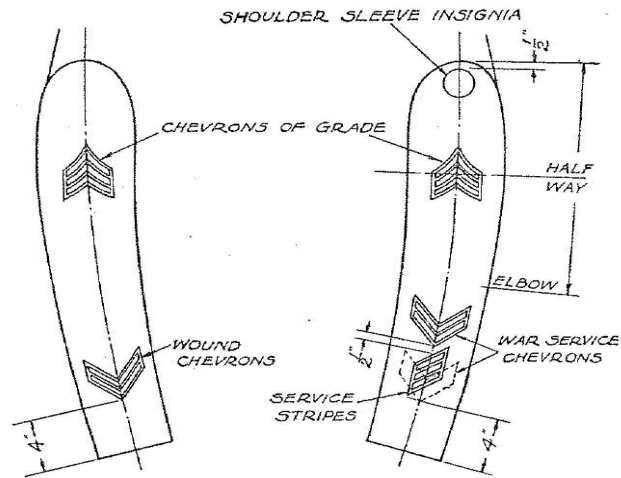

(4) Service coat, enlisted men.

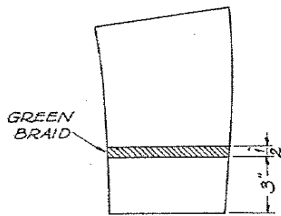

(5) Service coat and overcoat, warrant officers and enlisted men who served as officers during first World War.



(6) Service coat, Army Air Force technical specialists.

FIGURE 5. --Insignia on sleeve--Continued.

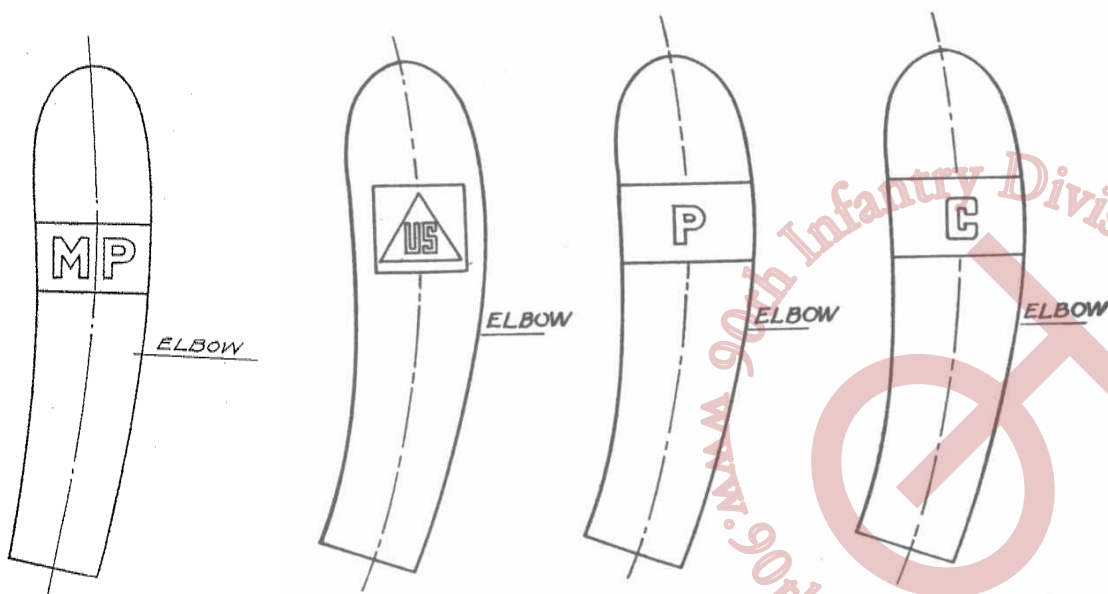

FIGURE 6. --Sleeve emblem and brassards.

90th Infantry Division Preservation Group
 www.90thidpg.us



(1) On shirt.



(2) On sleeve.

FIGURE 7. --Officer candidate school shirt insignia.

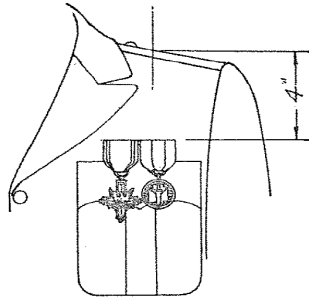

(1) Decorations, service medals.

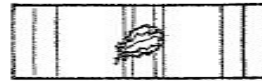

(2) Oak-leaf cluster on service ribbon of decoration.



(3) Oak-Leaf Clusters on decorations and on service ribbons of decorations

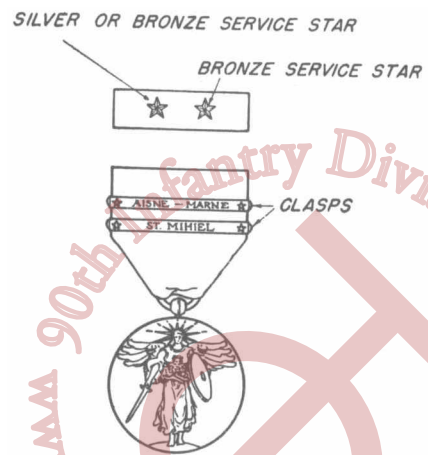

(4) Victory medal, service stars, and clasps.

FIGURE 8. --Decorations, service medals, etc.

90th Infantry Division Preservation Group
 www.90thidpg.us

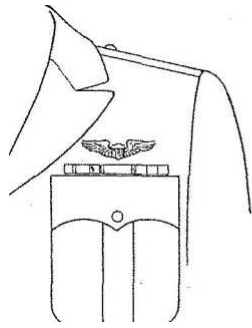

(5) Aviation badge; parachutists' badge.

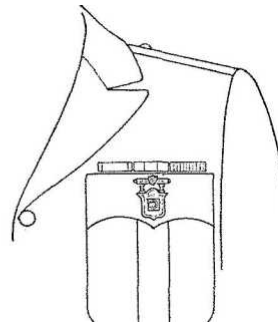

(6) Badges for marksmanship, gunnery, bombing, etc.

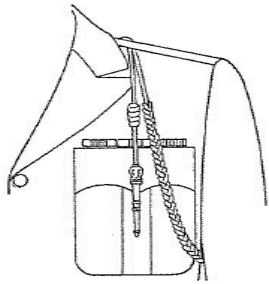

(7) Fourragere; service ribbons.

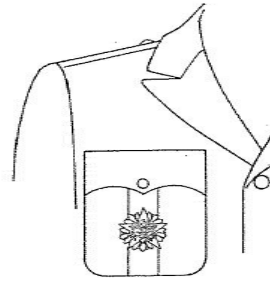

(8) War Department General Staff identification badge.

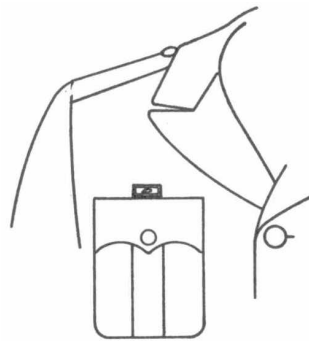

(9) Distinguished unit badge.

FIGURE 8. -Decorations, service medals, etc. -Continued.

