

TECHNICAL MANUAL

**UNIT AND DIRECT SUPPORT
MAINTENANCE MANUAL**

**GENERAL REPAIR PROCEDURES FOR
CLOTHING**

**This copy is a reprint which includes current
pages from Change 1.**

Approved for public release; Distribution is unlimited.

***This manual together with TM 10-8400-203-23 supersedes TM 10-8400-201-23,
30 June 1986, including all changes.**

**HEADQUARTERS, DEPARTMENT OF THE ARMY
7 MAY 1990**

CHANGE

NO. 6

HEADQUARTERS
DEPARTMENT OF THE ARMY
WASHINGTON, D.C., 4 August 1995

UNIT AND DIRECT SUPPORT
MAINTENANCE MANUAL
GENERAL REPAIR PROCEDURES FOR
CLOTHING

DISTRIBUTION STATEMENT A: Approved for public release; distribution is unlimited

TM 10-8400-201-23, 7 May 1990, is changed as follows:

1. Remove and insert pages as indicated below. New or changed text material is indicated by a vertical bar in the margin. An illustration change is indicated by a miniature pointing hand.

Remove pages	Insert pages
1-1 and 1-2	1-1 and 1-2
1-5 and 1-6	1-5 and 1-6
1-6.1/(1-6.2 blank)	1-6.1/(1-6.2 blank)
1-13 and 1-14	1-13 and 1-14
1-17 through 1-20	1-17 through 1-20
23-9/(23-10 blank)	23-9/(23-10 blank)

2. Retain this sheet in front of manual for reference purposes.

By Order of the Secretary of the Army:

Official:

JOEL B. HUDSON
*Acting Administrative Assistant to the
Secretary of the Army*
00624

DENNIS J. REIMER
*General, United States Army
Chief of Staff*

DISTRIBUTION:

To be distributed in accordance with DA Form 12-25-E, block no. 5099, requirements for TM 10-8400-201-23.

CHANGE
NO. 5

HEADQUARTERS
DEPARTMENT OF THE ARMY
WASHINGTON, D.C., 28 FEBRUARY 1994

UNIT AND DIRECT SUPPORT
MAINTENANCE MANUAL

GENERAL REPAIR PROCEDURES FOR
CLOTHING

DISTRIBUTION STATEMENT A: Approved for public release; distribution is unlimited.

TM 10-8400-201-23, 7 May 1990, is changed as follows:

1. Remove and insert pages as indicated below. New or changed text material is indicated by a vertical bar in the margin. An illustration change is indicated by a miniature pointing hand.

Remove pages

1-21 and 1-22
2-13/(2-14 blank)
3-19 through 3-26
3-29 through 3-40
4-13 and 4-14
5-7 and 5-8
6-11 through 6-17/(6-18 blank)
7-13 and 7-14
12-1 through 12-4
12-9 through 12-18
13-11 and 13-12
14-7/(14-8 blank)
15-19 and 15-20
16-9/(16-10 blank)
17-7 and 17-8
18-17 and 18-18
19-13 through 19-15/
(19-16 blank)
20-13 and 20-14
20-29 through 20-34
20-34.1/(20-34.2 blank)
20-35 and 20-36
20-36.1/(20-36.2 blank)
20-37 and 20-38
21-11/(21-12 blank)

Insert pages

1-21 through 1-23/(1-24 blank)
2-13/(2-14 blank)
3-19 through 3-26
3-29 through 3-40
4-13 and 4-14
5-7 and 5-8
6-11 through 6-17/(6-18 blank)
7-13 and 7-14
12-1 through 12-4
12-9 through 12-18
13-11 and 13-12
14-7/(14-8 blank)
15-19 and 15-20
16-9/(16-10 blank)
17-7 and 17-8
18-17 and 18-18
19-13 through 19-15/
(19-16 blank)
20-13 and 20-14
20-29 through 20-34
20-34.1/(20-34.2 blank)
20-35 and 20-36
20-36.1/(20-36.2 blank)
20-37 and 20-38
20-11/(21-12 blank)

2. Retain this sheet in front of manual for reference purposes.

By Order of the Secretary of the Army:

Official:

GORDON R. SULLIVAN
General, United States Army
Chief of Staff

MILTON H. HAMILTON
Administrative Assistant to the
Secretary of the Army
06483

DISTRIBUTION:

To be distributed in accordance with DA Form 12-25-E, block no. 5099, requirements for TM 10-8400-201-23.

CHANGE
NO. 4

HEADQUARTERS
DEPARTMENT OF THE ARMY
WASHINGTON, D.C., 15 December 1993

UNIT AND DIRECT SUPPORT
MAINTENANCE MANUAL

GENERAL REPAIR PROCEDURES FOR
CLOTHING

DISTRIBUTION STATEMENT A: Approved for public release; distribution is unlimited.

TM 10-8400-201-23, 7 May 1990, is changed as follows:

1. Remove and insert pages as indicated below. New or changed text material is indicated by a vertical bar in the margin. An illustration change is indicated by a miniature pointing hand.

Remove pages

iii through ix/(x blank)
1-5 and 1-6
- - - -
1-17 through 1-20
- - -
Index-1 through Index-16

Insert pages

iii through ix/(x blank)
1-5 and 1-6
1-6.1/(1-6.2 blank)
1-17 through 1-20
22-1 through 23-9/(23-10 blank)
Index-1 through Index-11/
(Index-12 blank)

2. Retain this sheet in front of manual for reference purposes.

By Order of the Secretary of the Army

Official:

MILTON H. HAMILTON
*Administrative Assistant to the
Secretary of the Army*
05976

GORDON R SULLIVAN
*General, United States Army
Chief of Staff*

DISTRIBUTION:

To be distributed in accordance with DA Form 12-25-E, block no. 5099, requirements for TM 10-8400-201-23.

CHANGE
NO. 3

HEADQUARTERS
DEPARTMENT OF THE ARMY
WASHINGTON, D.C., 15 December 1993

UNIT AND DIRECT SUPPORT
MAINTENANCE MANUAL
GENERAL REPAIR PROCEDURES FOR
CLOTHING

DISTRIBUTION STATEMENT A: Approved for public release; distribution is unlimited.

TM 10-8400-201-23, 7 May 1990, is changed as follows:

1. Remove and insert pages as indicated below. New or changed text material is indicated by a vertical bar in the margin. An illustration change is indicated by a miniature pointing hand.

Remove pages	Insert pages
i and ii	i and ii
v through viii	v through viii
-----	ix/(x blank)
20-1 through 20-8	20-1 through 20-8
-----	20-8.1/(20-8.2 blank)
20-9 through 20-12	20-9 through 20-12
-----	20-12.1/(20-12.2 blank)
20-13 through 20-26	20-13 through 20-26
-----	20-26.1/(20-26.2 blank)
20-27 through 20-34	20-27 through 20-34
-----	20-34.1/(20-34.2 blank)
20-35 and 20-36	20-35 and 20-36
-----	20-36.1/(20-36.2 blank)
20-37 and 20-38	20-37 and 20-38

2. Retain this sheet in front of manual for reference purposes.

By Order of the Secretary of the Army:

Official:

MILTON H. HAMILTON
*Administrative Assistant to the
Secretary of the Army*
05980

GORDON R. SULLIVAN
*General, United States Army
Chief of Staff*

DISTRIBUTION:

To be distributed in accordance with DA Form 12-25-E, block no. 5099, requirements for TM 10-8400-201-23.

CHANGE }
NO. 2 }

HEADQUARTERS
DEPARTMENT OF THE ARMY
WASHINGTON, D.C., 26 February 1993

UNIT AND DIRECT SUPPORT
MAINTENANCE MANUAL
GENERAL REPAIR PROCEDURES FOR
CLOTHING

DISTRIBUTION STATEMENT A: Approved for public release; distribution is unlimited.

TM 10-8400-201-23, 7 May 1990, is changed as follows:

1. Remove and insert pages as indicated below. New or changed text material is indicated by a vertical bar in the margin. An illustration change is indicated by a miniature pointing hand.

Remove pages

1-3 through 1-6
1-19 and 1-20
3-1 and 3-2
6-1 through 6-15/(6-16 blank)
11-19 and 11-20
12-17 and 12-18
20-5 and 20-6
20-13 through 20-16
20-29 through 20-38

Insert pages

1-3 through 1-6
1-19 and 1-20
3-1 and 3-2
6-1 through 6-17/(6-18 blank)
11-19 and 11-20
12-17 and 12-18
20-5 and 20-6
20-13 through 20-16
20-29 through 20-38

2. Retain this sheet in front of manual for reference purposes.

By Order of the Secretary of the Army:

Official:

MILTON H. HAMILTON
*Administrative Assistant to the
Secretary of the Army*
03825

GORDON R. SULLIVAN
*General, United States Army
Chief of Staff*

DISTRIBUTION:

To be distributed in accordance with DA Form 12-25-E, block no. 5099, requirements for TM 10-8400-201-23.

CHANGE
NO. 1

HEADQUARTERS
DEPARTMENT OF THE ARMY
WASHINGTON, D.C., 5 MARCH 1991

Unit and Direct Support
Maintenance Manual

GENERAL REPAIR PROCEDURES FOR
CLOTHING

Approved for public release, distribution is unlimited

TM 10-8400-201-23, 7 May 1990, is changed as follows:

1. Remove and insert pages as indicated below. New or changed text material is indicated by a vertical bar in the margin. An illustration change is indicated by a miniature pointing hand.

Remove pages

v and vi
3-1 and 3-2
3-11 and 3-12
3-25 and 3-26
3-33 and 3-34
5-7 and 5-8
11-7 and 11-8
11-23 and 11-24
11-27/(11-28 blank)
13-11 and 13-12

Insert pages

v and vi
3-1 and 3-2
3-11 and 3-12
3-25 and 3-26
3-33 and 3-34
5-7 and 5-8
11-7 and 11-8
11-23 and 11-24
11-27/(11-28 blank)
13-11 and 13-12

2. Retain this sheet in front of manual for reference purposes.

By Order of the Secretary of the Army:

CARL E. VUONO
General, United States Army
Chief of Staff

Official:

THOMAS F. SIKORA
Brigadier General, United States Army
The Adjutant General

DISTRIBUTION:

To be distributed in accordance with DA Form 12-25E, (qty rqr block no 3995)

WARNING

Toluene is a poisonous, flammable compound. Use only in well ventilated areas. Avoid repeated and prolonged contact with skin. Keep away from heat and open flame.

The coveralls are not fireproof and will char at about 700 to 800° F (370 to 430° C); therefore, ground egress procedures cannot be over emphasized.

The shirt and trousers are not fireproof and will char at about 700 to 800 F (370 to 430 C); therefore, egress cannot be over emphasized.

The jackets are not fireproof and will char at about 700 to 800° F (370 to 430° C); therefore, egress cannot be over emphasized.

Failure to correctly position release knob could result in a safety hazard. If the knob is in the up position it could interfere with the parachutist's reserve parachute.

Personnel engaged in welding should be equipped with welding goggles or hoods proper for type welding being done, and adequate precautions taken to prevent injury to the welder or other personnel.

Improper use of these garments can produce heat exhaustion within thirty minutes of hard work.

a/(b blank)

Technical Manual
 NO. 10-8400-201-23

HEADQUARTERS
 DEPARTMENT OF THE ARMY
 WASHINGTON D.C, 7 May 1990

**UNIT AND DIRECT SUPPORT MAINTENANCE MANUAL
 GENERAL REPAIR PROCEDURES FOR CLOTHING**

REPORTING ERRORS AND RECOMMENDING IMPROVEMENTS

You can help improve this manual. If you find any mistakes or if you know of a way to improve these procedures, please let us know. Mail your letter or DA Form 2028 (Recommended Changes to Publications and Blank Forms), or DA Form 2028-2 located in the back of this manual directly to: Commander, US Army Aviation and Troop Command, ATTN: AMSAT-I-MP, 4300 Goodfellow Blvd., St. Louis, MO 63120-1798. A reply will be furnished directly to you.

DISTRIBUTION STATEMENT A: Approved for public release; distribution is unlimited.

TABLE OF CONTENTS

		Paragraph	Page
Chapter	1. INTRODUCTION		
Section	I. General	1-1	1-1
	II. Item Classification	1-6	1-2
	III. Source, Maintenance and Recoverability	1-8	1-21
	IV. Administrative Publications.....		1-22
Chapter	2. MAINTENANCE OF UTILITY UNIFORMS		
Section	I. Introduction.....	2-1	2-1
	II. Repair Procedures.....	2-4	2-6
	III. Materials		2-13
Chapter	3. MAINTENANCE OF THE ARMY AVIATION AND COMBAT VEHICLE CREW MEMBERS HIGH TEMPERATURE AND FIRE RETARDANT CLOTHING		
Section	I. Introduction.....	3-1	3-1
	II. Repair Procedures.....	3-11	3-13
	III. Materials.....		3-33
Chapter	4. MAINTENANCE OF MEN'S COTTON/POLYESTER AND WOOL SERVICE TROUSERS		
Section	I. Introduction.....	4-1	4-1
	II. Repair Procedures.....	4-5	4-4
	III. Materials.....		4-13

* This manual together with TM 10-8400-203-23 supersedes TM 10-8400-201-23, 30 June 1986, including all changes.

TABLE OF CONTENTS (Continued)

		Paragraph	Page
Chapter	5. MAINTENANCE OF MEN'S WOOL, WOOL-NYLON SHIRT AND TROUSERS		
Section	I. Introduction.....	5-1	5-1
	II. Repair Procedures.....	5-5	5-3
	III. Materials.....		5-8
Chapter	6. MAINTENANCE OF SNOW CAMOUFLAGE PARKA AND-TROUSERS		
Section	I. Introduction.....	6-1	6-1
	II. Repair Procedures.....	6-5	6-4
	III. Materials.....		6-14
Chapter	7. MAINTENANCE OF MEN'S AND WOMEN'S FOOD HANDLER'S GARMENTS		
Section	I. Introduction.....	7-1	7-1
	II. Repair Procedures.....	7-5	7-6
	III. Materials.....		7-14
Chapter	8. MAINTENANCE OF THE COLD WEATHER CAP, HOT WEATHER CAP, BATTLE DRESS CAP, DESERT HAT, CAMOUFLAGE HAT, AND INSECT NET, AND EXTREME COLD WEATHER HOOD		
Section	I. Introduction.....	8-1	8-1
	II. Repair Procedures.....	8-5	8-8
	III. Materials.....		8-18
Chapter	9. MAINTENANCE OF MEN'S SERVICE COATS, OVERCOATS AND ALL-WEATHER COATS		
Section	I. Introduction.....	9-1	9-1
	II. Repair Procedures.....	9-4	9-11
	III. Materials.....		9-16
Chapter	10. MAINTENANCE OF MEN'S COLD WEATHER CLOTHING; COAT, PARKA AND TROUSERS		
Section	I. Introduction.....	10-1	10-1
	II. Repair Procedures.....	10-4	10-7
	III. Materials.....		10-25
Chapter	11. MAINTENANCE OF ROCKET FUEL HANDLERS' PROTECTIVE CLOTHING, TOXICOLOGICAL AGENTS PROTECTIVE CLOTHING, AND EXPLOSIVE HANDLER'S COVERALLS		
Section	I. Introduction.....	11-1	11-1
	II. Repair Procedures.....	11-4	11-12
	III. Materials.....		11-24

TABLE OF CONTENTS (Continued)

		Paragraph	Page
Chapter	12. MAINTENANCE OF LINERS FOR COLD WEATHER CLOTHING, DESERT PARKA, AND PONCHO		
Section	I. Introduction.....	12-1	12-1
	II. Repair Procedures.....	12-4	12-6
	III. Materials.....		12-18
Chapter	13. MAINTENANCE OF COATED NYLON PONCHO AND MEN'S COTTON AND POLYESTER/POPLIN RAINCOAT		
Section	I. Introduction.....	13-1	13-1
	II. Repair Procedures.....	13-5	13-5
	III. Materials.....		13-11
Chapter	14. MAINTENANCE OF MEN'S SERVICE SHIRTS		
Section	I. Introduction.....	14-1	14-1
	II. Repair Procedures.....	14-5	14-4
	III. Materials.....		14-7
Chapter	15. MAINTENANCE OF TEMPERATE, DAYTIME DESERT, AND HOT WEATHER BATTLE DRESS UNIFORM (BDU)		
Section	I. Introduction.....	15-1	15-1
	II. Repair Procedures.....	15-14	15-13
	III. Materials.....		15-20
Chapter	16. MAINTENANCE OF DESERT NIGHT PARKA AND TROUSERS		
Section	I. Introduction.....	16-1	16-1
	II. Repair Procedures.....	16-5	16-6
	III. Materials.....		16-9
Chapter	17. MAINTENANCE, WET WEATHER PARKA AND TROUSERS		
Section	I. Introduction.....	17-1	17-1
	II. Repair Procedures.....	17-4	17-4
	III. Materials.....		17-8
Chapter	18. MAINTENANCE OF WOMAN'S COAT, SKIRT AND SLACKS		
Section	I. Introduction.....	18-1	18-1
	II. Repair Procedures.....	18-4	18-13
	III. Materials.....		18-17
Chapter	19. MAINTENANCE OF WOMEN'S SERVICE SHIRTS		
Section	I. Introduction.....	19-1	19-1
	II. Repair Procedures.....	19-5	19-11
	III. Materials.....		19-14

TABLE OF CONTENTS (Continued)

		Paragraph	Page
Chapter	20. MAINTENANCE OF THE EXTENDED COLD WEATHER CLOTHING SYSTEM (ECWCS)		
Section	I. Introduction.....	20-1	20-1
	II. Maintenance Procedures	20-4	20-13
	III. Materials.....		20-29
Chapter	21. MAINTENANCE OF WOMAN'S MATERNITY WORK UNIFORMS		
Section	I. Introduction.....	21-1	21-1
	II. Repair Procedures.....	21-4	21-6
	III. Materials.....		21-11
Chapter	22. MAINTENANCE OF AIRCREW CLOTHING		
Section	I. Introduction.....	22-1	22-1
	II. Repair Procedures.....	22-6	22-6
	III. Materials.....		22-12
Chapter	23. REPAIR AND MAINTENANCE OF TWO PIECE CHEMICAL PROTECTIVE UNDERWEAR (TRAINING GARMENTS ONLY)		
Section	I. Introduction.....	23-1	23-1
	II. Repair Procedures.....	23-6	23-4
	III. Materials.....		23-9

LIST OF ILLUSTRATIONS

NUMBER	TITLE	PAGE
2-1.	Shirt Utility (Durable Press) Olive green 507, type 1	2-2
2-2.	Trousers, utility (Durable Press) Olive green 507, type 1	2-4
2-3.	Preparing a tear for patching	2-7
3-1.	CWU-27P Coverall, front and back	3-3
3-2.	GS/FRP Flight Gloves and Combat Vehicle Crewmembers' Summer Gloves, Front and Back	3-4
3-3.	Shirt and Trousers, front and back	3-5
3-4.	Lightweight Jacket, front and back	3-6
3-5.	Cold Weather Jacket, front and back	3-6
3-6.	Coverall Combat Vehicle Crewmember's	3-7
3-7.	Liner, Combat Vehicle Crewmember's Coveralls, Cold Weather	3-8
3-8.	Overall, Combat Vehicle Crewmember's	3-9
4-1.	Trousers, men 's, polyester/cotton, class I	4-3
4-2.	Trousers, men's, wool and polyester/wool	4-4
5-1.	Shirt, cold weather field, wool/nylon, olive green shade No.108.....	5-2
5-2.	Trousers, men's, field, wool M-195	5-3
6-1.	Parka, Snow Camouflage	6-2
6-2.	Trouser, Snow Camouflage, White, Arctic	6-3
7-1.	Apron, Food handlers, type 1	7-2
7-2.	Coat, food handlers, cotton drill, white, type 1	7-3
7-3.	Trousers, food handlers, cotton drill, white (class 2)	7-4
7-4.	Dress, food handler's, woman's	7-4
7-5.	Smock General Purpose	7-5
7-6.	Smock Food Inspector's	7-6
7-7.	Preparing a tear for patching.	7-8
8-1.	Hood, extreme cold weather, w/fur ruff, OG 107, M-65	8-4
8-2.	Cap, Cold Weather	8-5
8-3.	Cap, Hot Weather	8-6
8-4.	Hat and Insect Net/Hot Weather Sun Hat	8-6
8-5.	Cap, combat, woodland camouflage pattern	8-7
8-6.	Hat, camouflage pattern: desert	8-7
9-1.	Men's polyester/wool service coat	9-3
9-2.	Man's cotton and polyester poplin all-weather coat	9-4
9-3.	Man's acrylic fiber pile liner for all-weather coat	9-4
10-1.	Cold weather coat	10-4
10-2.	Men's trousers	10-5
10-3.	Extreme cold weather parka	10-6
11-1.	Rocket Fuel Handler's Full Protection Clothing	11-7
11-2.	Rocket Fuel Handler's Limited Protection Clothing	11-8
11-3.	Toxicological Agent's Protection Clothing	11-9
11-4.	Toxicological Agent's Protective Apron	11-10
11-5.	Explosive Handlers' Coveralls	11-11

LIST OF ILLUSTRATIONS - continued

NUMBER	TITLE	PAGE
12-1.	Cold Weather Parka and Coat Liners	12-3
12-2.	Trouser Liners	12-4
12-3.	Desert Parka Liner	12-4
12-4.	Wet Weather Poncho Liner	12-5
13-1.	Poncho, coated nylon, olive green shade 207, heavy duty. MIL-P-3033	13-3
13-2.	Raincoat, man's cotton and nylon, AG274	13-4
14-1.	Shirt, Man's, Long Sleeve, Green 415	14-3
14-2.	Shirt, Man's, Short Sleeve, Green 415	14-3
15-1.	Combat Camouflage Pattern Coat	15-3
15-2.	Combat Camouflage Pattern Trousers	15-4
15-3.	Preparing a tear for patching	15-14
16-1.	Desert Night Camouflage Parka	16-3
16-2.	Desert Night Camouflage Trousers	16-4
17-1.	Parka, Wet Weather	17-2
17-2.	Trousers, Wet Weather	17-3
18-1.	Coat, Woman's: Classic Design, Polyester/Wool	18-3
18-2.	Skirt, Woman's: Classic Design, Polyester/Wool	18-4
18-3.	Slacks, Woman's: Classic Design, Polyester/Wool	18-5
19-1.	Women's Polyester/Cotton Shirt, Bleached White	19-4
19-2.	Neck Tab and Band for Women's Shirts, Short Sleeve or Long Sleeve	19-5
19-3.	Women's Short Sleeve Shirt, Army Green 415	19-6
19-4.	Women's Long Sleeve Shirt, Army Green 415	19-7
20-1.	Parka, Extended Cold Weather, Camouflage	20-4
20-2.	Parka, Extended Cold Weather, Camouflage	20-5
20-3.	Trousers, Extended Cold Weather, Camouflage	20-7
20-4.	Trousers, Extended Cold Weather, Camouflage	20-8
20-4.1	Liner, Cold Weather Coat	20-8.1
20-4.2	Liner, Cold Weather Trousers, Field	20-8.1
20-5.	Shirt, Cold Weather, Polyester Fiberpile	20-9
20-6.	Overall, Bib, Cold Weather, Fiberpile	20-11
20-7.	Drawers, Cold Weather, Polypropylene	20-12
20-8.	Undershirt, Cold Weather, Polypropylene	20-12
20-8.1	Ruff, Parka, Extended Cold Weather	20-12.1
21-1.	Coat Woman's, Maternity Work Uniform	21-2
21-2.	Slacks, Woman's, Maternity Work Uniform	21-4
21-3.	Preparing A Tear For Patching.	21-7
22-1.	Coat, Aircrew, Combat	22-3
22-2.	Trousers, Aircrew, Combat	22-5
23-1.	Two Piece Chemical Protective Underwear (Undershirt and Drawers)	23-3
23-2.	Two Piece Chemical Protective Underwear, Repair	23-5

LIST OF TABLES

NUMBER	TITLE	PAGE
2-1.	National Stock Numbers for Shirt, Utility	2-3
2-2.	National Stock Numbers for Trousers Utility	2-5
2-3.	Stitching Instruction	2-9
2-4.	Shirt utility (Finished Measurements)	2-10
2-5.	Trousers, utility (Finished Measurements)	2-11
3-1.	Stitching Instructions	3-14
3-2.	FLYER'S SHIRT	3-16
3-3.	Flyer's Trousers	3-17
3-4.	Jacket, Flyer's, Lightweight	3-17
3-5.	Jacket, Flyers', Cold Weather	3-19
3-6.	Jacket, Flyer's	3-20
3-7.	Coverall, Combat Vehicle Crewmembers's	3-21
3-8.	National Stock Numbers for Coverall, CVC	3-21
3-9.	Liner, Coverall, Combat Vehicle Crewmember's	3-22
3-10.	National Stock Numbers for Liner, Coverall, CVC	3-23
3-11.	Overall, Combat Vehicle Crewmember's	3-24
3-12.	National Stock Numbers for Overall, Combat Vehicle Crewmembers	3-24
3-13.	Cuffs and Waistbands	3-25
3-14.	Glove Sizes	3-25
3-15.	Hook and Fastener Tape	3-28
3-16.	Slide Fasteners (V-F-106)	3-29
3-17.	Coverall National Stock Numbers	3-31
4-1.	Stitching Instructions	4-8
4-2.	Sizing Instructions for Trousers	4-10
4-3.	Sizing Instruction for Trousers	4-11
4-4.	Slide Fastener Guide	4-12
5-1.	Stitching Instructions	5-5
5-2.	Men's Wool Shirt Resizing Instructions	5-6
5-3.	Men's Wool Trousers Resizing Instruction	5-7
6-1.	Stitching Instructions (Parka and Trousers)	6-6
6-2.	Drawcord and Tape Lengths (Parka)	6-8
6-3.	Drawcord and Tape Lengths (Trousers)	6-8
6-4.	Slide Fastener Lengths (Trousers)	6-9
6-5.	Finished Measurements (Parka)	6-10
6-6.	Finished Measurements (Trousers)	6-10
6-7.	Parka Sizes	6-11
6-8.	Trouser Sizes	6-11
7-1.	Stitching Instructions	7-10
7-2.	Resizing Instructions	7-11
7-3.	Resizing Instructions	7-11
7-4.	Resizing Instructions	7-12
7-5.	Resizing Instructions	7-12

LIST OF TABLES (Continued)

NUMBER	TITLE	PAGE
7-6.	Resizing Instructions	7-13
10-1.	Finished measurements, Cold Weather Coats	10-10
10-2.	Finished Measurements, Men's Trousers	10-11
10-3.	Finished Measurements, Extreme Cold Weather Parka	10-11
12-1.	Parka Liner Finished Measurements	12-9
12-2.	Cold Weather Coat Liner Finished Measurements	12-9
12-3.	Trouser Liners, Olive Green, Finished Measurements	12-10
12-4.	Trouser Liners, Snow Camouflage, Finished Measurements	12-10
12-5.	Desert Night Parka Liner Finished Measurements	12-11
13-1.	Stitching Instructions	13-9
13-2.	Sizing Instructions and Finished Measurements (In Inches)	13-10
15-1.	National Stock Numbers for Temperate, Woodland Camouflage Coat	15-7
15-2.	National Stock Numbers for Daytime Desert Coat	15-8
15-3.	National Stock Numbers for Hot Weather, Woodland Camouflage Coat	15-9
15-4.	National Stock Numbers for Temperate Woodland Camouflage Trousers... ..	15-10
15-5.	National Stock Numbers for Daytime Desert Trousers	15-11
15-6.	National Stock Numbers for Hot Weather, Woodland Camouflage Trousers.....	15-12
15-7.	Stitching Instruction	15-16
15-8.	Camouflage Combat Coats	15-18
15-9.	Camouflage Combat Trousers	15-19
16-1.	National Stock Numbers for Desert Night Parka	16-5
16-2.	National Stock Numbers for Desert Night Trousers	16-5
16-3.	Finished Measurements of Desert Night Parka	16-8
16-4.	Finished Measurements of Desert Night Trousers	16-8
18-1.	Coat, Woman's, Classic Design, Polyester/Wool: Schedule of Sizes	18-6
18-2.	Skirt, Woman's, Classic Design, Polyester/Wool: Schedule of Sizes	18-9
18-3.	Slacks, Woman's, Classic Design, Polyester/Wool: Schedule of Sizes	18-11
18-4.	Stitching Instruction	18-14
18-5.	Procedures for stain removal.	18-16
19-1.	Women's Bleached White Short-Sleeve Shirt: Schedule of sizes	19-8
19-2.	Women's Army Green Short-Sleeve Shirt: Schedule of sizes	19-8
19-3.	Women's Army Green Long-Sleeve Shirt: Schedule of Sizes	19-10
20-1.	Stitching Instructions (Parka)	20-16
20-2.	Stitching Instructions (Trousers)	20-16
20-2.1.	Stitching Instructions (Coat and Trouser Liners)	20-17
20-3.	Stitching Instructions (Shirt)	20-17
20-4.	Stitching Instructions (Bib Overall)	20-17
20-5.	Stitching Instructions (Drawers and Under shirt)	20-17
20-6.	Drawcord and Tape Lengths (Parka)	20-18
20-7.	Drawcord and Tape Lengths (Trousers)	20-19
20-8.	Drawcord Lengths (Shirt)	20-19

LIST OF TABLES (Continued)

NUMBER	TITLE	PAGE
20-9.	Side Fastener Lengths (Undershirt)	20-20
20-9.1.	Stitching Instructions (Ruff)	20-20
20-10.	Finished Measurements (Parka)	20-21
20-11.	Finished Measurements (Trousers)	20-22
20-11.1.	Finished Measurements (Coat Liner)	20-22
20-11.2.	Finished Measurements (Trousers Liner)	20-23
20-12.	Finished Measurements (Shirt)	20-23
20-13.	Finished Measurements (Bib Overall)	20-23
20-14.	Finished Measurements (Undershirt)	20-24
20-15.	Finished Measurements (Drawers)	20-24
20-15.1.	Finished Measurements (Ruff)	20-24
20-16.	Parka Sizes	20-25
20-17.	Trousers Sizes	20-26
20-17.1.	Coat Liner Sizes	20-26.1
20-17.2.	Trousers Liner Sizes	20-26.1
20-18.	Shirt Sizes	20-27
20-19.	Bib Overall Sizes	20-27
20-20.	Undershirt Sizes	20-27
20-21.	Drawer Sizes	20-28
20-21.1.	Ruff Sizes	20-28
21-1.	Coat, Woman's, Maternity Work Uniform	21-3
21-2.	Slacks, Woman's, Maternity Work Uniforms	21-5
21-3.	Stitching Instruction	21-9
22-1.	Stitching	22-7
22-2.	Coat, Aircrew BDU, Sizing Instructions and Finished Measurements (in inches)	22-9
22-3.	Trousers, Aircrew BDU, Sizing Instructions and Finished Measurements (in inches)	22-9
22-4.	Slide Fastener Lengths (in inches)	22-10
23-1.	Undershirt Finished Measurements	23-6
23-2.	Drawers Finished Measurements	23-7

CHAPTER 1

INTRODUCTION

Section I GENERAL

1-1. SCOPE

This manual provides standards for the classification and repair of clothing. Each type of equipment is covered separately by a single chapter.

1-2. MAINTENANCE FORMS AND RECORDS

DA Forms and records used for the equipment maintenance will be only those prescribed in DA PAM 738-750.

1-3. DESTRUCTION OF ARMY MATERIEL TO PREVENT ENEMY USE

Demolition to prevent enemy use will be in compliance with instructions outlined in TM 750-244-3.

1-4. ADMINISTRATIVE STORAGE

Preparation, care, and removal of equipment in administrative storage will be in accordance with the following:

- a. Placement of equipment in administrative storage should be for short periods of time when a shortage of maintenance effort exists. Items should be in mission readiness within 24 hours or within the time factors as determined by the directing authority. During the storage period appropriate maintenance records will be kept.
- b. Before placing equipment in administrative storage, current maintenance services and equipment serviceable criteria (ESC) evaluations should be completed, shortcomings and deficiencies should be corrected, and all modification work orders (MWO's) should be applied.
- c. Storage site selection. Inside storage is preferred for items selected for administrative storage. If inside storage is not available, trucks, vans, conex containers and other containers may be used

1-5. REPORTING EQUIPMENT IMPROVEMENT RECOMMENDATIONS (EIR)

EIRs will be prepared using a DA Form SF 368, (Quality Deficiency Report). Instructions for preparing EIRs are provided in DA PAM 738-750, The Army Maintenance Management System. EIRs should be mailed directly to Commander, U.S. Army Aviation and Troop Command, ATTN: AMSAT-I-MDO, 4300 Goodfellow Boulevard, St. Louis, MO 63120-1798. A reply will be furnished directly to you.

Section II. ITEM CLASSIFICATION

1-6. ITEM CLASSIFICATION CRITERIA

a. ITEM CLASSIFICATION CODES. Refer to the table below for explanation of codes used to classify items by degree of serviceability.

CODE	EXPLANATION
A	New and unused property possessing original appearance and serviceability.
B	Serviceability as to be acceptable for issue or sale in lieu of class A like-new property. (1) Items peculiar to the clothing allowance system will possess a high degree of appearance and serviceability. These items affect the personal appearance of the individual and should be in such condition as to be readily acceptable for issue and cash sale purposes. In no case should the wear expectancy be less than 75 percent of a like-new item. (2) Items of organizational clothing and equipment will possess such appearance and degree of serviceability as to justify their issue to troops and afford a satisfactory military appearance. As a guide only and where practicable for application, these items should possess not less than 50 percent of the life of a like-new item.
F	Unserviceable items which are economically repairable. Economically repairable items are those which may be restored to Class B condition for not more than 65 percent (clothing) or equipment of prices contained in current Army Master Data File.
H	Unserviceable items which are obviously scrap or salvage, for which any use would require a repair cost exceeding 65 percent for clothing or equipment of the current cost of the item.
X	Items which do not possess the appearance or degree of serviceability to justify the classification of B or which cannot be repaired economically for the purpose originally intended, but which can be used as an end item (without benefit of repair) for duties which are harmful to clothing, i.e., mechanics, painters, construction workers, etc.

b. STANDARDS. As a general guide, classification of all clothing and equipment items will be subject to the stipulations and limitations listed below.

- (1) Items of personal clothing and footwear will be classified as new only when they show no evidence of color fading, stains, uncleanliness, and or rotting of stitching or fabric. Each item will be complete in every detail, and all parts properly designed and attached. A new item which has been tried on for size purposes, or from which the tags have been removed, will not be classed as used; nor will such items be soiled to the extent that dry cleaning or laundering is required. When dry cleaning or laundering is required, garment will be reclassified from new to used category. Only pressing of new garments or polishing of new leather footwear does not lower the classification.
- (2) Items of personal clothing and footwear will require the following for classification in a serviceable category (A or B):
 - (a) Complete state of repair. All repairs necessary to render the item completely serviceable will have been made.
 - (b) Cleaned. Must be in a dean (laundered, dry cleaned, or sterilized) condition.
 - (c) Buttons. Replacement buttons visible on outer garments when worn should be of a size, shape, and color like those originally affixed. Buttons which are not visible when a garment is being worn need not be specifically of the same color but should be of the same size.

1-6. ITEM CLASSIFICATION CRITERIA-Continued

- (d) Buttonholes. should not be enlarged or ripped.
- (e) Frayed Edges. No edge should appear ragged due to worn or broken threads.
- (f) Linings. Linings in all outer garments must be In a complete state of repair. Repair may include minor patches The patch does not have to exactly match the color of the lining, but should be reasonably similar in color.
- (g) Patches and darns. Patches and darns should be visible on outer dress clothing when worn.
- (h) Pockets. Pockets must be clean and in a complete state of repair Any repairs will be of a wear expectancy similar to that of the remainder of the garment Replaced pockets must be of a size consistent with those originally in garment.
- (l) Belt loops. All belt loops on trousers will be the same as on any new garment of a like make, including shade, material, and number.
- (j) Fading. Except for those Items designed as work-type garments, there should be no obvious fading.

NOTE

Fading which does not cause conspicuous deviation from original shade will be permitted for work-type garments.

- (k) Insignia marks. Chevron, overseas service organizational shoulder, or other Insignia marks, caused by fading or discoloration, will prohibit serviceable classification Insignia marks which are not conspicuous will be permitted on work-type garments.
 - (l) Identification marks. Marks of identification include those made at Issue point and those made by individuals These should be lined out or obliterated A mark is considered obliterated when its cancellation is readily evident.
 - (m) Spots and stains. Spots and stains should not be easily discernible at a casual glance when the garment is being worn.
 - (n) Hardware. Hardware will not be bent, broken, or missing Bright and shiny hardware will not disqualify items from a serviceable classification.
- (3) Items of organizational clothing and equipment will require the following for classification in serviceable condition codes (A and B).
- (a) Complete state of repair. See (2) (a) above.
 - (b) Cleaned. Must be In a clean (laundered, dry cleaned, sterilized, or painted) condition.
 - (c) Buttons. See (2) (c) above.
 - (d) Fasteners. All present and of the same size originally affixed to item.
 - (e) Buttonholes. See (2) (d) above.

1-6. ITEM CLASSIFICATION CRITERIA-Continued
--

- (f) Frayed edges. Frayed edges of an inconspicuous or minor nature will be permitted
 - (g) Linings. See (2) (f) above.
 - (h) Patches and darns. Patches and darns will be permitted, provided their color is similar to that of the original material
 - (i) Pockets. See (2) (h) above.
 - (j) Belt loops. See (2) (i) above.
 - (k) Fading. Fading will be permitted.
 - (l) Identifying marks. See (2) (1) above.
 - (m) Spots or stains.
 - 1 Items worn by individuals Small paint, grease, or other spots or stains will be permitted if garment or other item is otherwise completely serviceable
 - 2 All other organizational items. Spots and stains will not be considered a determining factor in classifying this category of property if such spots and stains are of a minor nature.
 - (n) Hardware See (2) (n) above.
 - (o) Footwear (Shoes and Boots).
 - 1 This item classification criteria applies to only Central Issue Facility (CIF), Organizational Clothing and Individual Equipment (OCIE) and Central Initial Issue Point Army Military Clothing Sales stores are not affected by this item classification criteria.
 - 2 Shoes and boots can be reissued if footwear is treated with a fungicidal spray designed for shoes and boots (procured locally) and is in like new condition, free from obvious stretching or creasing of leather upper indentations in soles of footwear caused by minimal wear is acceptable and suitable for Code A (See paragraph 1-6a).
 - (4) Rubber and canvas footwear, and boots, ski, men's leather will be classified in condition Codes A or B in accordance with the applicable provisions of (3) above.
 - (5) The Woodland Temperate, Daytime Desert, and Hot Weather Camouflage Clothing and individual Equipment items will be considered serviceable from a fading standpoint if the pattern is visually discernible and the colors are still subdued in nature
- c. DISPOSITION OF DISTINCTIVE ITEMS OF UNIFORM (AR 670-1).**
- (1) Decorations, badges, service awards, medals, ribbons, lapel buttons and other insignia and items of uniform, to include items cited in AR 670-1, will be mutilated to remove their distinctive characteristics prior to turn-in to the Defense Reutilization and Marketing Office (DRMO). Property will be turned in as scrap
 - (2) Items not considered distinctive, i.e., Army Green Coat and shirts will be turned in to the DRMO after the removal of distinctive buttons, insignia, and other such items, for disposition in accordance with DOD 4160.21M
- d. PRIORITY FACTORS.** In the classification of clothing and equipment, factors of appearance and serviceability inherent in the items will be considered on the following priority basis to determine final classification:
- (1) Items of personal clothing and footwear (excluding work-type uniforms). Appearance and serviceability-equal priority
 - (2) Organizational clothing and equipment and work type uniforms.
 - (a) Serviceability-first priority.
 - (b) Appearance-second priority.

1-7. INSPECTION/CLASSIFICATION PROCEDURES
--

- a. Instructions contained in this paragraph will be used as a guide in making inspections of clothing and individual equipment in the hands of units or individuals for the purpose of determining serviceability and repair eligibility.
- b. Restitching of open seams NOT to be counted as a tear with no limitation on length
- c. Previous repairs are NOT to be counted when determining maximum number of repairs.
 - (1) Maximum repairs mean the number of repairs authorized on an item each time it is turned in for repair
 - (2) Additional repairs are authorized as long as expenditure limits do not exceed 65 per cent replacement cost. Refer to TB 43-0002-27, Maintenance Expenditure Limits.

Apron, Food Handlers; Chapter 7

LIN A86247

11. Inspection Procedure: Inspect for rips, tears, stains, and missing or damaged tie strings
12. Classification:

Code A.	New and unused items that possess original appearance and serviceability.
Code B.	Used items that are not suitable for Code A but are dean and undamaged. Some permanent stains are acceptable.
Code F.	Unserviceable items that can be repaired by replacing tie strings and repairing minor holes (maximum repairs, 4 ea and maximum length of repairs is 6 inches).
Code H.	Unserviceable items that are obviously scrap or cannot meet the criteria for Code F.

Cap, Coldweather; Chapter 8

LIN D03476

1. Inspection Procedure: Inspect for rips, tears, holes, fraying, bums, grease, oil, other contaminants, and discoloration.
2. Classification:

Code A.	New and unused items possessing original appearance and serviceability.
Code B.	Used items that are not suitable for Code A and do not have fraying, bums and no more than 4 repaired areas.
Code F.	Unserviceable items that can be repaired and have no rips, tears, or holes exceeding 1 inch in diameter or length. Damage to the bib is cause for salvage. Some discoloration is acceptable. Maximum of 4 repairs per item.
Code H.	Unserviceable items that are obviously salvage or cannot meet the criteria for Code F.

1-7. INSPECTION/CLASSIFICATION PROCEDURES - Continued

**Coat, Aircrew, Combat; Chapter 22
No Assigned LIN**

1. Inspection Procedure. Inspect for rips, tears, stains, holes and bums. Check zippers, snaps, hook and pile fastener tapes for damage. Check for worn and faded areas.
 - Code A. New and unused items that possess original appearance and serviceability.
 - Code B. Used items that are not suitable for Code A but are clean, undamaged and having no more than 3 repaired areas (not including replacing zippers, snaps and fastener tapes). Slight fading is acceptable.
 - Code F. Unserviceable items that can be repaired (not more than 3 repaired areas, maximum length of repair 4 inches) or by replacing zippers, snaps, and fastener tapes Slight fading is acceptable.
 - Code H. Unserviceable items that are obviously scrap or cannot meet the criteria for Code F.

**Coat, Food Handlers (Men and Women's); Chapter 7
LIN E43782**

1. Inspection Procedure: Inspect for rips, tears, stains, and missing or damaged buttons.
2. Classification:
 - Code A. New and unused items that possess original appearance and serviceability.
 - Code B. Used items that are not suitable for Code A but are clean, have no more than 4 repaired areas and undamaged. Permanent stains are acceptable; maximum 4 permanent stains not exceeding 3 inches in diameter or length.
 - Code F. Unserviceable items that can be repaired (maximum repairs 4, maximum length of repair 6 inches) by replacing missing or damaged buttons.
 - Code H. Unserviceable items that are obviously scrap or cannot meet the criteria for Code F.

1-7. INSPECTION/CLASSIFICATION PROCEDURES - Continued
--

**Coat, Woman's Maternity Work Uniform; Chapter 21
UN C45280**

1. Inspection Procedure: Check for rips, tears, worn areas, altered length or tops, missing or damaged buttons, discoloration, soiled area and dryrot.
2. Classification:
 - Code A. New and unused items possessing original appearance and reserviceability.
 - Code B. Used items not suitable for Code A but are dean, undamaged, unstained and have no more than 2 small repaired areas.
 - Code F. Unserviceable items that can be repaired (no more than 2 repaired areas, maximum diameter of 1/2 inch) by replacing missing or damaged button, unstitching of button holes and seams.
 - Code H. Unserviceable items that are obviously scrap, or cannot meet the criteria for Code F.

**Coverall, Flyers; Chapter 3
LIN F32124**

1. Inspection Procedure: Inspect for rips, tears, holes, stains, and burns. Check zippers, snaps, velcro fasteners, and waist adjusting straps for damage. Check for worn and faded areas.
2. Classification:
 - Code A. New and unused items possessing original appearance and serviceability.
 - Code B. Used items that are not suitable for Code A but are clean, undamaged, unstained and having no more than 5 repaired areas (not including replacing zippers, snaps and velcro fasteners). Slight fading is acceptable.

1-7. INSPECTION/CLASSIFICATION PROCEDURES-Continued

- Code F. Unserviceable items that can be repaired (no more than 5 repaired areas, maximum length of repair 4 inches) or by replacing zippers, snaps, and velcro fasteners. Slight fading is acceptable.
- Code H. Unserviceable Items that are obviously scrap or cannot meet the criteria for Code F

**Coveralls, Mechanics Cold Weather
LIN F31439**

1. Inspection Procedures: Inspect for loose, missing, or broken seam threads. Check that all zippers are operational and pull tabs are present. Inspect pockets for rips, tears, and holes. Check that all elastic is present and serviceable (legs and sleeves). Check inside liner for damage and outside shell for holes, tears, rips, or chemical saturations.
2. Classification
 - Code A. Items are new and unused and possess original appearance and serviceability.
 - Code B. Used Items that are not suitable for Code A but are clean, undamaged, and having no soiled areas that make the material stiff or odor saturated.
 - Code F. Unserviceable items that can be repaired and can be laundered so that the material is pliable and odor free. Stains are not a criteria for washout. Items will have no more than 6 repaired areas and maximum allowable length of repair is 10 inches. Fading or discoloration is permissible provided the Item resembles original color intent.

**Coveralls, Mechanics, Warm Weather
LIN F32466**

1. Inspection Procedure' Check for rips, tears, holes, burns, dry rot, oil grease, and other contaminants. Check for missing or damaged zippers, snaps, and/or buttons. Check cuffs on legs and arms for fraying or tears. Check for wear in the seat, elbow and knee area.
2. Classification:
 - Code A. New and unused items possessing original appearance and serviceability.
 - Code B. Used items that are not suitable for Code A but are clean, undamaged, and have no soiled areas that make the material stiff or odor saturated.
 - Code F. Unserviceable items that can be repaired and can be laundered so that the material is pliable and odor free. Stains are not a criteria for washout. Items will have no more than 6 repaired areas and maximum allowable length of repair is 10 inches. Fading or discoloration is permissible provided the item resembles original color intent
 - Code H. Unserviceable Items that are obviously scrap or cannot meet the criteria for Code F.

1-7. INSPECTION/CLASSIFICATION PROCEDURES-Continued

**Drawers, Cold Weather, Polypropylene,
No Assigned LIN**

1. Inspection Procedure Inspect for rips, tears, stains, discoloration, and cleanliness.
2. Classification
 - Code A. New and unused items that possess original appearance and serviceability.
 - Code B. Used Items that are not suitable for Code A, but are clean, unstained, and have no rancid smell or bad odor.
 - Code F. Unserviceable items that can be laundered so that material is clean and odor free. Repair is limited to restitching of open seams only
 - Code H Unserviceable items that are obviously scrap or cannot meet the criteria for Code F.

**Hood, Extreme Cold Weather W/Liner
LIN K46058**

1. Inspection Procedure. Inspect item for rips, tears, holes, burns, oil, grease, and other contaminants. Check for missing or damaged drawstring, buttons, buttonholes, and velcro fasteners. Check liner for fraying, burned areas, dry rot, and broken or bent wires
2. Classification:
 - Code A New and unused Items possessing original appearance and serviceability.
 - Code B Used items that are suitable for Code A must be complete, clean, and have no more than 3 repaired areas and be suitable for Issue as is
 - Code F. Unserviceable items that can be repaired by replacing drawstrings or velcro fasteners. Rips and tears can be repaired provided the hole or tear does not exceed 1 inch in length or diameter and no more than 3 repaired areas. Burns, dry rot, and fur damage is cause for salvage Wires can be straightened or replaced.
 - Code H Unserviceable items that are obviously scrap or cannot meet the criteria for Code F.

**Jacket, Flyers, Cold Weather MA-1
LIN L14567**

1. Inspection Procedure Check for rips, tears, holes, stains, and burns. Check zippers and velcro fasteners for damage Check cuffs and waistband for damage or fraying. Check for worn areas.
 2. Classification:
 - Code A. New and unused Items possessing original appearance and serviceability.
 - Code B. Items that are unsuitable for Code A but are clean, undamaged, unstained, and have no more than 3 repaired areas (not including replacing zippers, velcro fasteners, cuffs, and waistband). Light fading is acceptable
-

1-7. INSPECTION/CLASSIFICATION PROCEDURES-Continued

- Code F. Unserviceable items that can be repaired (no more than 3 repaired areas, maximum length of repair 2 inches) and by replacing zippers, snaps, velcro fasteners, cuffs, and waistband.
- Code H. Unserviceable Items that are obviously scrap or cannot meet the criteria for Code F.

**Jacket, Flyers, Lightweight L2B
LIN L14475**

1. Inspection Procedure: Check for rips, tears, holes, stains, and burns. Check zippers and velcro fasteners for damage. Check cuffs and waistband for damage or fraying. Check for worn areas.
2. Classification:

- Code A. New and unused Items possessing original appearance and serviceability.
- Code B. Items that are unsuitable for Code A but are clean, undamaged, unstained, and have no more than 3 repaired areas (not including replacing zippers, velcro fasteners, snaps, cuffs, and waistband). Slight fading is acceptable.
- Code F. Unserviceable Items that can be repaired (no more than 3 repaired areas, maximum length of repair 2 inches) or by replacing zippers, velcro fasteners, cuffs, and waistband.
- Code H. Unserviceable Items that are obviously scrap or cannot meet the criteria for Code F.

**Jacket, Flyers, Synthetic/Natural N2B
LIN L14978**

1. Inspection Procedure: Check for rips, tears, holes, stains, and burns. Check zippers, snaps, and drawstrings for damage. Inspect cuffs and waistband for rips, tears, or fraying. Check hoods for damage to fur liner and collar. Check buttons and loops for damage if missing.
2. Classification

- Code A. New and unused items possessing original appearance and serviceability.
- Code B. Used Items that are unsuitable for Code A but are clean, undamaged, unstained, and have no more than 3 repaired areas (not including replacing zippers, snaps, drawstrings, buttons, loops, cuffs, and waistbands) Slight fading is acceptable.
- Code C. Unserviceable Items that can be repaired (no more than 3 repaired areas, maximum length of repair 2 inches) or by replacing zippers, snaps, drawstrings, buttons, loops, cuffs, and waistband.
- Code H. Unserviceable Items that are obviously scrap or cannot meet the criteria for Code F.

1-7. INSPECTION/CLASSIFICATION PROCEDURES-Continued

**Liner, Coat Mohair
LIN L69967**

1. Inspection Procedure: Inspect for rips, tears, holes, burns, damaged buttonholes, dry rot, and any type damage to the mohair liner. Check for oil, grease or other contaminants
2. Classification
 - Code A. New and unused items that possess original appearance and serviceability.
 - Code B. Used items that are not suitable for Code A; must be clean, undamaged, no dry rot, and no more than 6 repaired areas
 - Code F. Unserviceable items that can be repaired by sewing or patching rips, tears, or burns. Rips or tears exceeding 6 inches, burns, exceeding 4 inches, or dry rot are not repairable, no more than 6 repairs per Item. Discoloration is acceptable provided item resembles original color intent (not bleached) Repairs, which alter length or width will require the item to be marked to meet the next closest size
 - Code H. Unserviceable Items that are obviously scrap or cannot meet the criteria for Code F.

**Liner, Coat, Nylon
LIN L70172**

1. Inspection Procedure Inspect for holes, rips, tears, burns, oil, grease, and other contaminants.
2. Classification.
 - Code A. New and unused Items possessing original appearance and serviceability.
 - Code B. Used Items that are not suitable for Code A; must be clean, and have no more than 6 repaired areas. Discoloration is acceptable provided that item resembles original color intent (not bleached).
 - Code F. Unserviceable items that can be repaired by sewing or patching. Seam separation can be repaired. Rips or tears in other areas can be no longer than 6 inches. No more than 6 patches per Item. Burned areas exceeding 3 inches are not repairable. Repairs which alter the length or width will require the Item to be marked to meet the next closest size.
 - Code H. Unserviceable items that are obviously scrap or cannot meet the criteria for Code F.

**Liner, Parka, Mohair
LIN L70652**

1. Inspection Procedure: Inspect for rips, tears, holes, burns, damaged button holes, dry rot, and any type damage to the mohair liner. Check for oil, grease, or other contamination.
 2. Classification
 - Code A. New and unused Items possessing original appearance and serviceability.
-

1-7 INSPECTION/CLASSIFICATION PROCEDURES-Continued

- Code B. Used items that are not suitable for Code A, are clean, undamaged, no dry rot, and have no more than 6 repaired areas.
- Code F. Unserviceable items that can be repaired by sewing or patching rips, tears, or burns. no more than 6 repairs per item. Rips or tears exceeding 6 inches, burns exceeding 4 inches, or dry rot is not repairable. Discoloration is acceptable provided the Item resembles original color Intent (not bleached) Repairs which alter original length or width will cause the Items to be marked to the next closest size.
- Code H. Unserviceable items that are obviously scrap or cannot meet the criteria for Code F.

**Liner, Parka, Nylon
LIN L70720**

1. Inspection Procedure Inspect for holes, rips, tears, burns, damaged button holes, oil, grease, and other contaminants.
2. Classification:
 - Code A New and unused Items possessing original appearance and serviceability.
 - Code B. Used items that are not suitable for Code A, are clean, with no more than 6 repaired areas.
 - Code F. Unserviceable Items that can be repaired by sewing or patching. Any seam separation can be repaired. Rips or tears In other areas can be no longer than 6 inches and no more than 6 repairs per Item. Burned areas exceeding 3 inches are not repairable. Discoloration is acceptable provided the item resembles original color intent (not bleached) Repairs which alter length or width will cause the item to be marked to the next closest size.
 - Code H Unserviceable Items that are obviously scrap or cannot meet the criteria for Code F.

**Liner, Trouser, Mohair
LIN L71855**

1. Inspection Procedure. Inspect for rips, tears, holes, burns, damaged button holes, dry rot, stains, and damage to the mohair liner.
 2. Classification:
 - Code A. New and unused Items possessing original configuration and serviceability.
 - Code B. Used items which are not suitable for Code A, but are clean, undamaged, and have no more than 6 repaired areas.
-

1-7. INSPECTION/CLASSIFICATION PROCEDURES-Continued

Code F. Unserviceable items that can be repaired by sewing or patching rips and tears (maximum length 8 inches) and no more than 6 repairs per Item. Any seam separation can be repaired. Burned areas exceeding 3 inches are not repairable. Discoloration is acceptable provided the item resembles original color intent (no bleached). Repairs which alter original length or width will require the item to be marked to meet the next closest size.

Code H. Unserviceable items that are obviously scrap or cannot meet the criteria for Code F.

**Liner, Trousers, Nylon
LIN L72022**

1 Inspection Procedure Inspect for rips, tears, holes, damaged buttonholes, oil, grease, or other contaminants.

2 Classification:

Code A. New and unused items possessing original appearance and serviceability.

Code B. Used items that are not suitable for Code A, are clean, and have no more than 6 repaired areas.

Code F. Unserviceable items that can be repaired by sewing or patching. Items that have more than 6 repaired areas (maximum 6 inch patch) or any burned area exceeding 4 inches is cause for salvage. Discoloration is acceptable provided the item resembles original color intent (not bleached). Repairs which alter length or width will cause the item to be marked to the next closest size.

Code H. Unserviceable items that are obviously scrap or cannot meet the criteria for Code F.

**Mitten Set, Cotton/Nylon
LIN M52829**

1. Inspection Procedure. Check for rips, tears, holes, seam separation, worn palms, and that the leather is soft and pliable. Check for missing or damaged snaps, adjusting straps, neck string for carrying gloves, and nylon or mohair insert. Check fur on back of mitten for rips, tears, or wear.

2. Classification:

Code A. New and unused Items possessing original appearance and serviceability.

Code B. Used Items that are not suitable for Code A but are clean, undamaged, soft and pliable, have no more than 2 repaired areas on the canvas portion of the glove, and 3 repaired areas on the insert.

Code F. Unserviceable items that can be repaired (2 repaired areas on the canvas portion on the glove and 3 repairs on the insert, maximum length of repair 3 Inches) or by replacing snaps, adjusting straps, and neck strings. No repairs authorized on the leather portion of the glove.

Code H. Unserviceable Items that are obviously scrap or cannot meet the criteria for Code F.

1-7. INSPECTION/CLASSIFICATION PROCEDURES - Continued**Overall, Bib, Cold Weather, Fiberpile
LIN P56983**

1. Inspection Procedure: Inspect for rips, tears, damaged or missing zippers hanger loop, buckles, and suspenders.
2. Classification:
 - Code A. New and unused items that possess original appearance and serviceability.
 - Code B. Unused items that are not suitable for Code A but are dean, undamaged and have no more than 5 repaired areas.
 - Code F. Unserviceable items that can be repaired by replacing missing or damaged zippers, buckles, suspenders, hangar loops and restitching of ripped seams or loose stitching.
 - Code H. Unserviceable items that are obviously scraps or cannot meet the criteria for Code F.

**Parka, Cold Weather, w/hood
LIN N69973**

1. Inspection Procedure: Inspect for rips, tears, damaged or missing zippers, snaps, and drawstrings. Check for discoloration, dry rot, and fraying.
2. Classification:
 - Code A. New and unused items possessing original appearance and serviceability.
 - Code B. Used items that are not suitable for Code A but are dean, complete, undamaged, and have no more than 1 repair on the hood and 6 repairs on the remainder of the item. Minimal discoloration and slight fraying are acceptable.
 - Code F. Unserviceable item that can be repaired by replacing zippers, snaps, and drawstrings Items requiring more than 1 repair to the hood and/or 6 repairs to the garment body are nonrepairable. Maximum length of repair is 2 inches on the hood and 4 inches on the garment body. Minimal discoloration is acceptable and some fraying is repairable provided it does not require reconfiguration of the item. Minimal soiling is acceptable.
 - Code H. Unserviceable items that are obviously scrap or cannot meet the criteria for Code F.

**Parka, Cold Weather w/o Hood
LIN N69904**

1. Inspection Procedure: Inspect for rips, tears, damaged or missing zippers, snaps, and drawstrings. Check for discoloration, dry rot, and fraying.

1-7. INSPECTION/CLASSIFICATION PROCEDURES - Continued

2. Classification:

- Code A. New and unused items possessing original appearance and serviceability.
- Code B. Used items that are not suitable for Code A but are dean, complete, undamaged, and have no more than 6 repaired areas. Minimal discoloration or slight fraying is acceptable.
- Code F. Unserviceable items that can be repaired (maximum 6 repairs per garment and maximum length of repair 4 inches) by replacing missing or damaged zippers, snaps, and drawstrings. Some discoloration and minimal soiling are acceptable.
- Code H. Unserviceable items that are obviously scrap or cannot meet the criteria for Code F.

**Parka, Extended Cold Weather, Camouflage
LIN P69699**

1. Inspection Procedure: inspect for rips, tears, damaged or missing zippers snaps, drawstrings, and hook and pile fastener tapes. Check for discoloration, dry rot and fraying.

2. Classification:

- Code A. New and unused items possessing original appearance and serviceability.
- Code B. Used items that are not suitable for Code A, but are dean, undamaged, and serviceable.
- Code F. Unserviceable items that can be repaired (maximum 5 repair and maximum length of repair totaling 15 inches in length) by replacing missing or damaged snaps, drawcords, pockets, pocket flaps, hangers, elastic webbing and bartack. Some discoloration and minimal soiling are acceptable. Replacement of zipper and repair of zipper is authorized.
- Code H. Unserviceable items that are obviously scrap or cannot meet the criteria for Code F

**Parka, Wet Weather
LIN N70110**

1. Inspection Procedure: Check for rips, tears, holes, dry rot, and damaged or missing velcro fasteners, grommets, drawstrings, or zipper.

2. Classification:

- Code A. New and unused items possessing original appearance and serviceability.
- Code B. Used items that are not suitable for Code A, but are dean, undamaged, complete, and have no more than 3 repaired areas. (Patches).

1-7. INSPECTION/CLASSIFICATION PROCEDURES-Continued

Code F. Unserviceable items that can be repaired (no more than 3 repaired areas (patches) and maximum length of repair 3 inches) or by replacing velcro fasteners, grommets, drawstrings, or zippers.

Code H. Unserviceable items that are obviously scrap or cannot meet the criteria for Code F.

**Scarf, Wool
LIN S52982**

1. Inspection Procedure: Inspect for rips, tears, holes, burns, shrinking, stretching, discoloration, oil, grease, or other contaminants.

2. Classification:

Code A. New and unused items possessing original appearance serviceability.

Code B. Used items that are not suitable for Code A but are suitable for issue with no more than 2 repaired areas on each side (total 4 repaired areas).

Code F. Unserviceable Items that can be repaired by sewing. Rips or tears exceeding 3 inches in length or diameter, or Items that are longer than 60 inches or shorter than 45 inches are cause for salvage. Some discoloration is acceptable.

Code H. Unserviceable Items that are obviously salvage or cannot meet the criteria for Code F.

**Shirts, Cold Weather, Polyester Fiberpile
LIN S03222**

1. Inspection Procedure: Inspect for rips, tears, damaged or missing zippers loose or broken stitching, missing or torn draw cords, eyelets, loops, pocket flaps and pockets.

2. Classification

Code A. New and unused Items that possess original appearance and serviceability.

Code B. Unused items that are not suitable for Code A but are clean, unstained, undamaged, and have no more than 5 repaired areas

Code F. Unserviceable items that can be repaired by replacing missing or damaged pockets, zippers, loops, pocket flaps, and restitching or ripped seams or loose stitching.

Code H. Unserviceable items that are obviously scrap or cannot meet the criteria for Code F.

**Shirt, Cold Weather, Wool
LIN T04205**

1. Inspection Procedure. Check for rips, tears, worn areas, missing or damaged buttons, separated seams, broken threads, shrinkage, and soiled areas.

1-7. INSPECTION/CLASSIFICATION PROCEDURES - Continued

2. Classification:

- Code A. New and unused items possessing original appearance and serviceability.
- Code B. Used items that are not suitable for Code A but are clean, undamaged, complete, possess minimal nap loss and have no more than 4 repaired areas.
- Code F. Unserviceable items that can be repaired (maximum 4 repairs per item) and can be resized if shrinkable has occurred. Some nap loss is acceptable. Soiled areas that cannot be removed by dry cleaning are cause for salvage. Maximum length of repair is 4 inches.
- Code H. Unserviceable items that are obviously salvage or cannot meet the criteria for Code F.

**Shirt, Cotton Polyester
No Assigned LIN**

1. Inspection Procedure: Inspect for rips, tears, stains, and discoloration. Inspect button holes for elongations and fraying. Check zipper, if applicable.

2. Classification:

- Code A. New and unused Items that possess original appearance and serviceability.
- Code B. Used items that are not suitable for Code A but are clean, unstained, and have no more than 2 repaired areas exceeding 1/2 inch.
- Code F. Unserviceable items that can be repaired by sewing damaged areas of less than 1/2 inch. No more than 2 repaired areas are authorized. Items must possess a professional appearance and contain no permanent stains or discoloration. Replacement of buttons and repair of zipper, if applicable.
- Code H. Unserviceable items that are obviously scrap or cannot meet the criteria for Code F.

**Slacks, Women's, Maternity Work Uniform
LIN S68769**

1. Inspection Procedure: Check for rips, tears, worn areas, missing or damaged buttons, elastic wristband and stretch panel, loose or broken stitching and dry rot.

2. Classification:

- Code A. New and unused items possessing original appearance and serviceability

1-7. INSPECTION/CLASSIFICATION PROCEDURES - Continued

- Code B. Used items not suitable for Code A but are dean, undamaged, unstained and have no more than 2 small repair areas
- Code F. Unserviceable items that can be repaired (no more than 2 repaired areas, maximum diameter of 1/2 inch) by replacing missing or damaged buttons, restitching buttonholes and seams. Repair or replacement of elastic waistband and stretch panel is authorized.
- Code H. Unserviceable items that are obviously scrap and cannot meet the criteria for Code F

**Smock, Medical Assistant (Male)
LIN S84286**

1. Inspection Procedure: Inspect for rips, tears, stains, and missing or damaged buttons.
2. Classification

- Code A. New and unused items that possess original appearance and serviceability.
- Code B. Used items that are not suitable for Code A but are dean, unstained, and have no more than 2 small repaired areas.
- Code F. Unserviceable items that can be repaired (maximum repairs 2, maximum length of repair 1/2 inch). Item cannot have any permanent stains and must have a professional appearance.
- Code H. Items that are obviously scrap or cannot meet the criteria for Code F.

**Trousers, Aircrew, Combat; Chapter 22
No Assigned LIN**

1. Inspection Procedure: Inspect for rips, tears, stains, holes and bums. Check zippers, snaps, hook and pile fastener tapes for damage. Check for worn and faded areas.
2. Classification:

- Code A. New and unused Items that possess original appearance and serviceability.
- Code B. Used items that are not suitable for Code A but are clean, undamaged and having no more than 3 repaired areas (not including replacing zippers, snaps and fastener tapes). Slight fading is acceptable
- Code F. Unserviceable items that can be repaired (not more than 3 repaired areas, maximum length of repair 4 inches) or by replacing zippers, snaps, and fastener tapes. Slight fading is acceptable.
- Code H. Unserviceable items that are obviously scrap or cannot meet the criteria for Code F

**Trousers, Cold Weather, Cotton/Nylon
LIN X35057 and UN X36109**

1. Inspection Procedure: Inspect for rips, tears, worn areas, missing or damaged belt loops, buttons, snaps, zippers, drawstrings, and leg straps. Check for discoloration, soiling, and dry rot.

1-7. INSPECTION/CLASSIFICATION PROCEDURES - Continued

2. Classification:

- Code A. New and unused items possessing original appearance and serviceability.
- Code B. Used items that are not suitable for Code A but are dean, undamaged, complete, have minimal discoloration, and no more than 6 repaired areas.
- Code F. Unserviceable items that can be repaired (maximum 4 repairs and 4 inches in length). Minimal discoloration or soiling is acceptable. Missing or damaged parts can be replaced.
- Code H. Unserviceable items that are obviously scrap or cannot meet the criteria for Code F.

**Trouser, Cotton Polyester
No. Assigned LIN**

1. Inspection Procedure: Inspect for stains, discoloration, and cleanliness. Check for unserviceable elastic band and for loose or broken stitching. Inspect for rips, tears, and holes.

2. Classification:

- Code A. New and unused items that possess original appearance and serviceability.
- Code B. Used items that are not suitable for Code A but are dean, unstained, undamaged, and have no more than 2 small repaired areas.
- Code F. Unserviceable items that can be repaired by sewing damaged areas of less than 1 inch. No more than 2 repaired areas is authorized. Items must possess a professional appearance and contain no permanent stains or discolorations. Replacement of damaged or unserviceable elastic band is authorized.
- Code H. Unserviceable items that are obviously scrap or cannot meet the criteria for Code F

**Trousers, Extended Cold Weather, Camouflage
LIN: T35375**

1. Inspection Procedure: Inspect for rips, tears, damaged or missing zippers, snaps, drawstrings and barrel lock, and missing or damaged hook and pile fastener tapes.

2. Classification:

- Code A. New and unused items possessing original appearance and serviceability.
- Code B. Used items that are not suitable for Code A but are dean, undamaged and have no more than 5 repaired areas.
- Code F. Unserviceable items can be repaired (maximum 5 repairs and maximum length of repairs totaling 15 inches in length) by replacing missing or damaged snaps, drawcords, suspender, loops and hook and pile fastener tapes. Replacement and repair of zippers is authorized.
- Code H. Unserviceable items that are obviously scraps or cannot meet the criteria for Code F.

1-7. INSPECTION/CLASSIFICATION PROCEDURES - Continued**Trousers, Food Handlers (Male); Chapter 7
UN X35947**

1. Inspection Procedure: Inspect for rips, tears, stains, and missing or damaged zippers, fasteners, belt loops, and buttons.
2. Classification:
 - Code A. New and unused items that possess original appearance and serviceability.
 - Code B. Used items that are not suitable for Code A but are dean, have no more than 4 repaired areas and undamaged. Permanent stains are acceptable; maximum 4 permanent stains not to exceed 3 inches in diameter or length.
 - Code F. Unserviceable items that can be repaired (maximum repairs 4, maximum length of repair 6 inches) by replacing missing or damaged buttons.
 - Code H. Unserviceable items that are obviously scrap or cannot meet the criteria for Code F.

**Trousers, Medical Assistant (Male)
LIN T36211**

1. Inspection Procedure: Inspect for rips, tears, stains, and missing or damaged buttons. Check for missing or damaged zippers, fasteners, and belt loops.
2. Classification:
 - Code A. New and unused items that possess original appearance and serviceability.
 - Code B. Used items that are not suitable for Code A but are clean, unstained, undamaged and have no more than 2 small repaired areas.
 - Code F. Unserviceable items that can be repaired (maximum repairs 2, maximum length of repair ½ inch). Item cannot have any permanent stains and must have a professional appearance.
 - Code H. Unserviceable items that are obviously scrap or cannot meet the criteria for Code F.

**Trousers, Wet Weather
LIN N37752**

1. Inspection Procedure: Inspect for rips, tears, holes, dry rot, and missing or damaged velcro fasteners, drawstrings, and waist loops.
2. Classification:
 - Code A. New and unused items possessing original appearance and serviceability.
 - Code B. Used items that are not suitable for Code A but are dean, undamaged, complete, and have no more than 3 repaired areas (patches).

1-7. INSPECTION/CLASSIFICATION PROCEDURES - Continued

Code F. Unserviceable items that can be laundered so that material is clean and odor free Repair is limited to restitching of open seams only

Code H. Unserviceable items that are obviously scrap or cannot meet the criteria for Code F.

**Undershirt, Cold Weather, Polypropylene,
No Assigned LIN**

1. Inspection Procedure: Inspect for rips, tears, damaged or missing zipper, stains, discoloration and cleanliness.

2. Classification:

- (a) Code A. New and unused items that possess original appearance and serviceability
- (b) Code B. Used items that are not suitable for Code A, but are clean, unstained, undamaged, and have no rancid smell or bad odor
- (c) Code F. Unserviceable items that can be laundered so that material is dean and odor free. Repair is limited to restitching of open seams only.
- (d) Code H. Unserviceable items that are obviously scrap or cannot meet the criteria for Code F.

**Underwear, Two Piece Chemical Protective; Chapter 23
No Assigned LIN**

1. Inspection Procedure: Examine regularly for tears, punctures, or damage to material. Check slide fastener for serviceability, proper attachment to undershirt and loose or missing teeth. Check hook and pile material for serviceability, and proper attachment to underwear.

2. Classification

- Code A. New and unused items possessing original appearance and serviceability.
- Code B. Used items not suitable for Code A but are undamaged and wear life is less than 15 days, may be issued as is.
- Code F. Unserviceable items that can be repaired (Training Garment only) by replacing slide fastener, hook and loop fastener tape, and by repairing ripped seams and tears.
- Code H. Unserviceable items that are obviously scrap or cannot meet the criteria for Code F and cannot be used for training.

Section III. SOURCE, MAINTENANCE AND RECOVERABILITY

1-8. SOURCE, MAINTENANCE AND RECOVERABILITY (SMR) CODES

The SMR Identifies the Source Code (SRC-CD), Maintenance Level and Recoverability Code (RECOV-CD).

- a. Source Code (first two positions). The Source Code Is a two-digit code assigned to an item to indicate the manner in which it is to be required for maintenance, repair or overhaul of an end item.

CODE	EXPLANATION
PA	Item procured and stocked for anticipated or known usage.
PB	Item procured and stocked for Insurance purposes because essentiality dictates that a minimum quantity must be available in the supply system
PC	Item procured and stocked which otherwise would be coded PA except that it is deteriorative in nature.
PD	Support item, excluding support equipment, procured for initial issue or outfittings and stocked only for subsequent or additional initial issues or outfittings. Not subject to automatic replenishment; i.e., installation kits, Modification Work Order (MWO) kits, and special purpose crew/operator tool kits.
PE	Support equipment procured and stocked for initial issue or outfitting to specified maintenance repair activities.
PF	Support equipment which will not be stocked but which will be centrally procured on demand.
PG	Item procured and stocked to provide sustained support for the life of the equipment. It is applied to an item peculiar to the equipment which, because of probable discontinuance or shutdown of production facilities, would prove uneconomical to reproduce at a later time.
KD	An item of depot overhaul/repair kit and not purchased separately. Depot kit defined as a kit that provides items required at the time of overhaul or repair
KF	An item of a maintenance kit and not purchased separately. Maintenance kit defined as a kit that provides an item that can be placed at unit or Intermediate categories of maintenance.
KB	Item included In both a depot overhaul repair kit and a maintenance kit.
MO	Item to be manufactured or fabricated at the unit category of maintenance.
MH	Item to be manufactured or fabricated at the Intermediate General Support (IGS) maintenance category.
ML	Item to be manufactured or fabricated at the Specialized Repair Activity (SRA).
MF	Item to be manufactured or fabricated at the Intermediate Direct Support (IDS) maintenance category.
MD	Item to be manufactured or fabricated at depot maintenance category.
AO	Item to be assembled from stock numbered components at the unit category of maintenance.
AF	Item to be assembled at the IDS maintenance category.
AH	Item to be assembled at IGS maintenance category.

1-8. SOURCE, MAINTENANCE AND RECOVERABILITY (SMR) CODES - Continued

CODE	EXPLANATION
AL	Item to be assembled at the SRA.
AD	Item to be assembled at depot maintenance category.
XA	Item is not procured or stocked, because the requirements for the item will result in the replacement of the next higher assembly.
XB	Item is not procured or stocked. If not available through salvage, requisition.
XC	Installation drawing, diagram, instruction sheet, field service drawing, that is identified by manufacturer's part number.
XD	A low mortality support item that is not stocked. When required, items will be requested and provided through normal supply channels.

b. Maintenance Use Code (third position). This position will indicate the lowest maintenance category authorized to remove, replace, and use the support item. The maintenance use entered in the third position will indicate one of the following categories of maintenance.

CODE	EXPLANATION
O	Support item is removed, replaced, and used at organizational (or AVUM/ON-SITE) category of maintenance.
F	Support Item is removed, replaced, and used at direct support (or AVIM/OFF-SITE) category of maintenance.
H	Support item is removed, replaced, and used at general support (or AVIM/OFF-SITE) category of maintenance.
D	Support item is removed, replaced, and used only at depot.

c. Maintenance Repair Code (fourth position). This position will indicate whether or not the item is to be repaired, and will identify the lowest category with the capability to perform complete repair. This complete repair excludes overhaul or rebuild functions prescribed by Depot Maintenance Work Requirements(DMWR), but encompasses performing all other authorized maintenance functions, services (inspect, test, service adjust, align, calibrate), or actions (welding, grinding, riveting, straightening, facing, remachining, or resurfacing) required to restore an item to serviceable condition by correcting specific failures or damage. Complete repair coding does not preclude repair which may be authorized to a lower category of maintenance. The MRC entered in the fourth position will indicate one of the following:

CODE	APPLICATION/EXPLANATION
O	The unit (AVUM/ON-SITE) category of maintenance is the lowest level capable of complete repair.
F	The IDS (AVIM/OFF-SITE) category of maintenance is the lowest level capable of complete repair.
H	The IGS (AVIM/OFF-SITE) category of maintenance is the lowest level capable of complete repair.
L	The SRA is the lowest activity capable of complete repair.

1-8. SOURCE, MAINTENANCE AND RECOVERABILITY (SMR) CODES - Continued

CODE	APPLICATION/EXPLANATION
D	The depot category of maintenance is the lowest level capable of complete repair.
B	No repair is authorized. The item may be reconditioned by adjusting lubricating, etc. at the user level. No parts or special tools are required for the maintenance of this item.
Z	Nonrepairable. No repair is authorized.

d. Recoverability Code (fifth position). Indicates the disposition action on unserviceable items.

CODE	EXPLANATION
O	Repairable item. When uneconomically repairable, condemn and dispose at organizational level.
F	Repairable item. When uneconomically repairable condemn and dispose at Direct Support.
H	Repairable. When uneconomically repairable, condemn and dispose at General Support.
D	Repairable. When beyond lower maintenance level repair capability, return to depot for disposal.
L	Repairable. When uneconomically repairable, condemn and dispose at a specialized repair activity.
A	Item requires special handling or condemnation procedures because of specific reasons (i.e. precious metal content, high dollar value, critical material or hazardous material). Refer to appropriate manuals/directives for specific instructions.
Z	Nonrepairable item. When unserviceable condemn and dispose at the maintenance level indicated in the third position

Section IV. ADMINISTRATIVE PUBLICATIONS

PUB. NO.	TITLE
AR 710-1	Centralized Inventory Management of the Army Supply System
AR 710-2	Supply Policy Below the Wholesale Level
AR 725-50	Requisitioning, Receipt and Issue System
AR 750-1	Army Material Maintenance Concepts and Policies
DOD 4160-21-M	Defense Disposal Manual
Fed Std 757	Stitches, Seams, and Stitching
TB 43-0002-27	Maintenance Expenditure Limits for FSC Groups 72, 83, 84 and FSC Classes 7210-8340, and 8400
FM 10-16	General Fabric Repair

**CHAPTER 2
MAINTENANCE OF UTILITY UNIFORMS**

Section I. INTRODUCTION

2-1. SCOPE

This chapter provides instructions that cover the materials, methods, and procedures for repair and maintenance of the utility shirt and trousers, durable press.

2-2. COMMODITY SPECIFICATIONS

a. Items

ITEM	SPECIFICATION
Shirt, Utility (Durable Press) OG-507	MIL-S-43929
Trousers, Utility (Durable Press) OG-507	MIL-T-43932

b. Components.

ITEM	SPECIFICATION
Button, Sewing Hole, and Button, Staple, Plastic	V-B-871
Fasteners, Slide, Interlocking	V-F-106
Thread, Cotton	V-T-276
Thread, Cotton Gimp, Buttonhole	V-T-280
Thread, Polyester	V-T-285
Cloth, Twill, Polyester/Cotton (Durable Press)	MIL-C-43791
Thread, Polyester, Cotton-covered	MIL-T-43548
Tape, Textile, Cotton, General Purpose, Natural or in Colors	MIL-T-43566
Cloth, Poplin, Cotton, for Heat Seal Patching	MIL-C-43667 (GL)

2-3. IDENTIFICATION AND DESCRIPTION**a. Shirt**

- (1) Shirt, Utility (Durable Press) OG-507 (table 2-1).
- (2) This shirt (fig. 2-1) Is fabricated from cloth, twill, polyester/cotton, durable press, olive green 507. It is a loose-fitting garment with six button front, two outside patch pockets with button-down flaps; and a button on each cuff. The shirt tall has a square design and is worn inside the trousers.

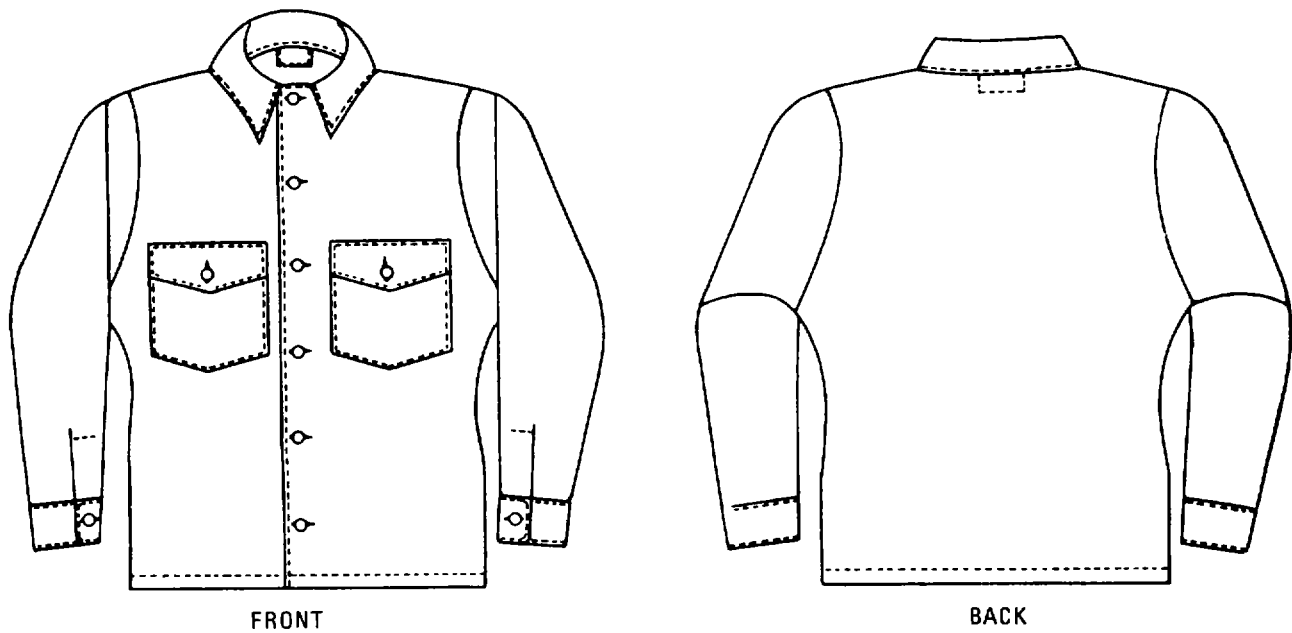

Figure 2-1. Shirt Utility (Durable Press) Olive green 507, type 1

2-3. IDENTIFICATION AND DESCRIPTION-Continued

Table 2-1. National Stock Numbers for Shirt, Utility

NATIONAL STOCK NUMBER	NECK SIZE	SLEEVE LENGTH
8405-01-075-1235	12 1/2	29
8405-01-075-1236	12 1/2	31
8405-00-614-9938	13 1/2	30
8405-00-614-9943	13 1/2	32
8405-00-614-9970	14 1/2	31
8405-00-615-0004	14 1/2	33
8405-00-615-0005	15 1/2	31
8405-00-615-0026	15 1/2	33
8405-00-615-0166	15 1/2	35
8405-00-615-0237	16 1/2	32
8405-00-615-0273	16 1/2	34
8405-00-615-0312	16 1/2	36
8405-00-615-0325	17 1/2	32
8405-00-615-0382	17 1/2	34
8405-00-615-0385	17 1/2	36
8405-00-615-0389	18	35

2-3. IDENTIFICATION AND DESCRIPTION-Continued**b. Trousers**

(1) Trousers, Utility (Durable Press) OG-507 (Table 2-2).

(2) The utility trouser (fig. 2-2) is fabricated from cloth, twill, polyester/cotton, durable press, olive green 507. It has two slash pockets in front and two patch pockets with button-down flaps in back, and a slide fastener front closure with a button at top of the waistband.

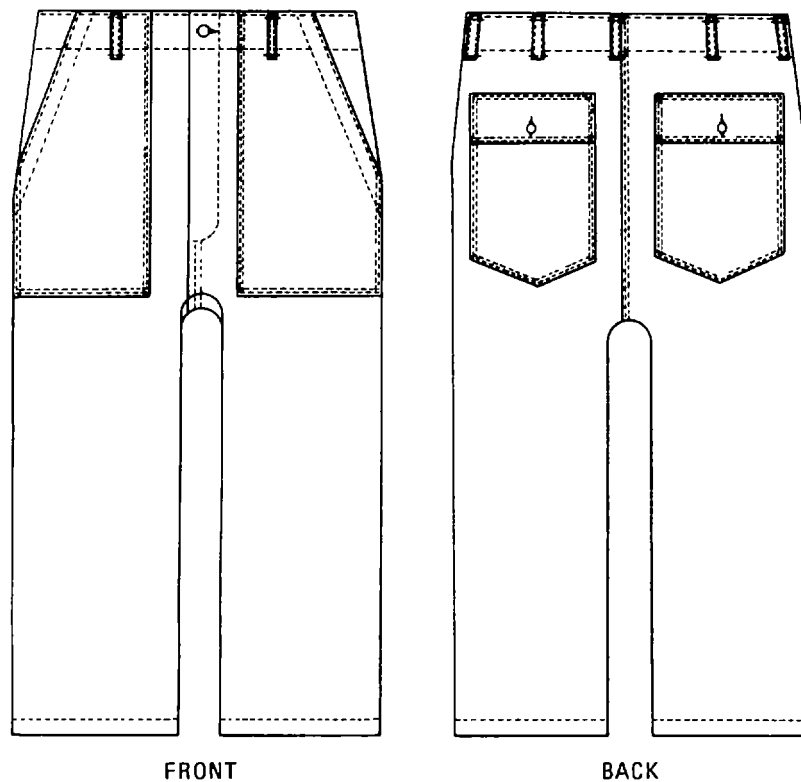

Figure 2-2. Trousers, utility (Durable Press) Olive green 507, type 1

2-3. IDENTIFICATION AND DESCRIPTION-Continued

Table 2-2. National Stock Numbers for Trousers Utility

NATIONAL STOCK NUMBER	WAIST SIZE	INSEAM LENGTH
8405-01-075-1224	24	27
8405-01-075-1225	24	29
8405-01-075-1226	26	25
8405-01-075-1227	26	27
8405-00-610-2586	26	29
8405-00-610-2587	26	31
8405-01-075-1228	28	25
8405-01-075-1229	28	27
8405-00-610-2591	28	29
8405-00-610-2593	28	31
8405-00-610-2594	28	33
8405-01-075-1230	30	25
8405-01-075-1231	30	27
8405-00-610-2595	30	29
8405-00-610-2597	30	31
8405-00-610-2599	30	33
8405-00-610-2601	30	35
8405-01-075-1232	32	25
8405-01-075-1233	32	27
8405-00-610-2618	32	29
8405-00-610-2619	32	31
8405-00-610-2620	32	33
8405-00-610-2644	32	35
8405-00-610-2647	34	29
8405-00-610-2654	34	31
8405-00-610-2655	34	33
8405-00-610-2661	34	35
8405-00-610-2691	36	29
8405-00-610-2693	36	31
8405-00-610-2694	36	33
8405-00-610-2695	36	35
8405-00-610-2696	38	31
8405-00-610-2697	38	33
8405-00-610-2700	38	35
8405-00-610-2703	40	31
8405-00-610-2704	40	33
8405-00-610-2706	42	31
840500-610-2713	42	33
8405-00-610-2714	44	31
8405-00-610-2716	44	33
8405-00-610-2585	46	33

Section II. REPAIR PROCEDURES

2-4. MATERIALS

General materials used in the repair of the shirt and trousers shall be serviceable materials recovered from similar salvaged items when authorized, or will be new materials as specified in section III. New materials will be requisitioned from stock numbers and item description and shall conform to the appropriate specifications. When not available from stock, the materials may be purchased locally that conform as closely as possible to the standard material.

2-5. REPAIR AND MAINTENANCE OF UNIFORMS

Prior to repair operations, each Item shall be inspected by qualified personnel to determine the amount of repair necessary. The following methods shall be observed as fully as skills, facilities, funds, and local conditions permit. The sequence of operations shall be determined by the repairing organization, unless otherwise prescribed.

- a. Inspection. Inspect all items to determine the amount of repairs needed and whether such repairs can be accomplished within the organization or evacuate to Direct Support level of Maintenance.
- b. Repair. The following repairs will be accomplished by hand or organizational maintenance.
 - (1) Replace missing or damaged buttons and loose belt loops.
 - (2) Cement patching of rips and tears. Cement patching of loose seams.
 - (3) Iron-on patches. Rips and tears other than stress points (e.g., crotch seams, pockets seams, pocket flap seams, etc) may be repaired by iron-on patches. Any rip or tear closer than $\frac{3}{4}$ inch (1.91 cm) to any seam will be repaired by sewing.

2-5. REPAIR AND MAINTENANCE OF UNIFORMS-Continued

NOTE

Iron-on patches are suitable for use on the utility shirt and trousers when garment appearance is not first priority.

- (a) Patch size. The iron-on patch shall be cut to the size and shape that it will extend approximately 3/4 inch (1.91 cm) in all directions beyond the tear or other damage. Patches will have rounded corners.
- (b) Patching procedure for iron-on patches. When patching by hand iron, place patch to the inside of the garment. The garment may be turned inside out or the patch may be inserted within the garment, taking care that the patch is centered in the desired position. Trim heavily ravelled ends with scissors. Smooth out the area to be patched so that the tear is closed or very nearly closed, and so there will be no wrinkles, folds, seams, or other protrusions under the iron when it is applied (fig. 2-3).

Pre-warm the area to be patched by pressing with a household electric dry iron or steam iron used dry. With the iron set at the cotton indicator or as high as possible without scorching the fabric, apply the iron for 5 seconds or more. Immediately position the patch. Hold the iron on the patch for above 12 seconds.

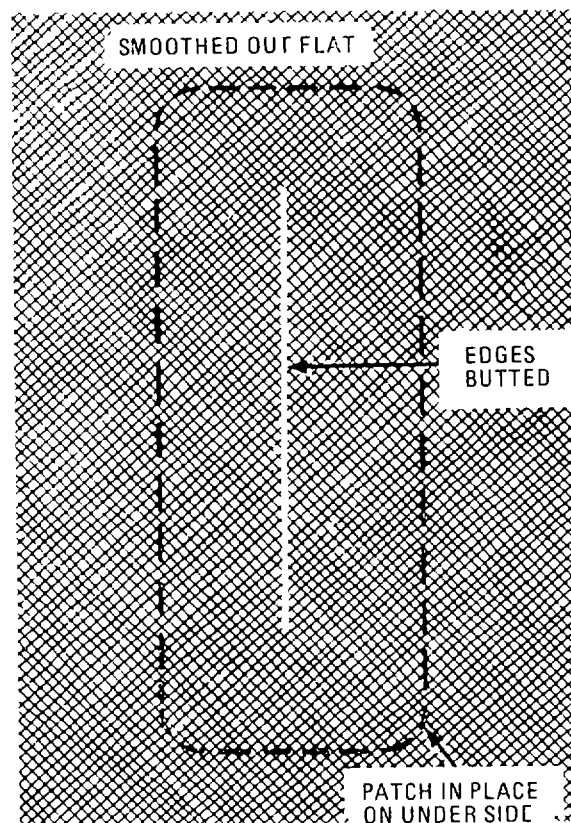

Figure 2-3. Preparing a tear for patching

2-5. REPAIR AND MAINTENANCE OF UNIFORMS-Continued

Use no more than a slight rotating motion of the iron and apply constant pressure. Remove the iron and allow the patched area to cool in place about 5 seconds, or long enough so that the patch will not drift off when the garment is removed from the ironing board.

Patches that are longer than the Iron may be ironed in sections, starting at the center and completing each section before proceeding to the next section. Overlapping of the iron upon previously bonded section is permissible. Carefully trim away any frayed protrusions at the torn edges.

- (c) Quality control. Adjust heating, pressing, and cooling times as required for the iron being used. Check the quality of the adhesive bond periodically and adjust heating times and temperatures.

NOTE

Check Test. Periodically during the work and when adjusting the iron, test a patch which has cooled for about 5 minutes by picking with the fingers at the edge of the patch until a tab about 1/4- to 1/2-inch (0.74 cm to 1.27 cm) long is formed. Pull hard on the tab with fingers. A well bonded tab will indicate that iron adjustment and heating time are adequate. Replace the test patch with a new patch.

1. If the adhesive strikes through the patch cloth, too much heat has been applied. Reduce time of pressing or temperature of the iron. A small amount of strike-through is not objectionable provided the patch meets the check test.
 2. A bonded patch which has a lifted edge will be re-ironed. A bonded patch which has been subjected to the check test will be replaced.
 3. When patching by special automatic press, the platen temperature, dwell time, dwell pressure, and other details shall be in accordance with the press manufacturer's Instructions.
- c. Cleaning. Items shall be cleaned by individual laundering or by utilizing laundry facilities provided at the installation.
- d. Direct Support Level of Maintenance.
- (1) Preliminary examination and cleaning. Dirt, mud, dust, spots, mildew stain, and other foreign matter shall be removed with a brush or by laundering. Mildewy and rotten items shall be discarded. Seams shall be tested by grasping the item with both hands and pulling at right angles to the seam. Areas to be repaired shall be marked with crayon. Non-specification and personnel marks shall be erased or obscured.
 - (2) Laundry. Items shall be processed in laundry facilities in accordance with established practices set forth in FM 10-280. When such facilities are not available, items shall be laundered by contract with private Industry in accordance with accepted commercial laundry practices.

2-5. REPAIR AND MAINTENANCE OF UNIFORMS-Continued

- (3) Patching Garments may be patched by either the iron on or stitched patches.
- (4) Sewing machine repairs, stitching and restitching. All sewing, except emergency repair, shall be machine sewn. When ends of machine stitching type 301 are not caught in other seams or stitching, they shall be backstitched not less than 1 inch (2.54 cm) at each break. Ends of a continuous line of stitching shall overlap not less than 1/2 inch (1.27 cm). Thread breaks (all stitch types) shall be repaired by stitching back of the break not less than 1/2 inch (1.27 cm). Thread tension shall be properly maintained to avoid loose stitching and locks shall be imbedded in the center of the material sewn. Thread breaks in edge stitching shall be overlocked not less than 3/4 inch (1.91 cm) at each break. Stitch spacing used for restitching and type of seams, shall be the same as in all construction. Seams with loose and/or weak thread shall be restitched. For illustrations of the various types of stitches used, see FED STD.-751. The following types of stitch, thread size and stitches per inch 2.54 cm) are required for the repair (table 2-3).

Table 2-3. Stitching Instruction

ITEM NO.	LOCATION	STITCH TYPE	THREAD NEEDLE BOBBIN		STITCHES PER INCH
1 and 2	GENERAL	301	50/3	50/3	10-14
1 and 2	GENERAL	401	50/3	50/3	10-14
1 and 2	OVEREDGE STITCHING	502 503 504	50/3	50/3	6-10
1 and 2	*BARTACKS	BARTACKS	50/3	50/3	28 PER BARTACK
1 and 2	*BUTTONHOLES	BUTTONHOLES	50/3	50/3	44-46 PER BUTTONHOLE
1 and 2	*BUTTONS	101 OR 301	50/3	20-24 50/3	PER BUTTON 14-16 PER BUTTON
1 and 2	*EYELETS	EYELET MACHINE	50/3	50/3	19-24 PER EYELET

* May be repaired by hand using double ply of 50/3 thread.

- (5) Patching and darning. Patching and darning may be applied to any area of the two Items. Repair small tears not more than 1/2 inch (1.27 cm) across with a darning or zigzag stitch. Patch holes with a diameter of 1/4 inch (0.635 cm) or more. Repair rips, tears, and thin areas greater than 1/2 inch (1.27 cm) by patching. Patches shall be limited to a maximum of 2 Inches (5.08 cm) in the greatest dimension. Patches shall match the garment in color and type of material. Insert patch under damaged area; cut away damaged area and turn edges under approximately 3/8 inch (0.952 cm). Cut patch large enough to extend not less than 1/2 inch (1.27 cm) and not more than 1 inch (2.54 cm) around the perimeter of the opening with 3/8 inch (0.952 cm) turn-under of all edges except salvage edges. Pre-cut all patches to provide for symmetry. Materials shall be those specified in section III.
- (a) Buttons. Replace missing, loose, or damaged buttons with buttons conforming to those listed in section III. Attach the buttons securely and aligned with eyelet of respective buttonholes.

2-5. REPAIR AND MAINTENANCE OF UNIFORMS-Continued

- (b) Buttonholes. Buttonholes shall be of the eyelet-end taper-bar type worked over gimp. Repair damaged buttonholes by reshaping enlarged buttonholes before reworking. Pull into shape and hand or machine whip a small reinforcement patch to the underside of the buttonhole. Then rework buttonhole through the patch.
 - (c) Belt loops and drawcord. Replace missing, broken or torn belt loops and drawcords with new parts of matching size and material. Such parts shall be fastened in a like manner to those being replaced and shall be properly positioned. Material for drawcord shall conform to that listed in section III.
 - (d) Pockets. Darn or machine patch small rips at corners or broken seams. Inside hanging pockets shall be repaired by piecing, when required.
 - (e) Hems. Turn under all frayed hems and stitch in place.
 - (f) Slide fasteners. Replace missing or defective slide fasteners with parts conforming to type specified in section III.
- (6) Resizing. Resize all garments after complete repair and cleaning according to item group schedule of sizes listed below. When items deviate in size from original marking, obliterate the old marking and print or stamp the proper size with an indelible pencil or waterproof ink near the old size. When the measurements do not correspond to a size listed, remark items to correspond to the next lowest size. Items with measurements falling below the lowest measurement in the schedule will not be accepted for remarking. Refer to appropriate table for measuring and sizing Instructions for each garment.
- (b) Shirt, utility, OG-507 (table 2-4).

NOTE

Chest. Chest measurement shall be taken with shirt buttoned at a point in line with pit of armhole, from folded edge to folded edge.

Back length. Back length shall be taken along center of back from under collar seam to bottom edge of shirt.

Sleeve length. Sleeve length shall be taken from center back of shirt at under collar seam diagonally across back along sleeve to bottom edge of sleeve.

**Table 2-4. Shirt utility
(Finished Measurements)**

Neck Size	1/2 Chest	Back Length	Sleeve Length
12 1/2	18	27 3/8	1/2 inch over marked size or as measured if altered during repairs.
13 1/2	20	28 3/8	
14 1/2	22	29 3/8	
15 1/2	24	30 3/8	
16 1/2	26	31 3/8	
17 1/2	28	32 3/8	
18	29	32 7/8	
Tolerance	.314	+ 1/2	+ 3/8 INCH

2-5. REPAIR AND MAINTENANCE OF UNIFORMS-Continued

(b) Trousers, Utility, OG-507 (table 2-5).

NOTE

Waist. With the waistband buttoned, measure along center of waistband from side fold to side fold.

Inseam. Measure inseam of trousers from crotch to bottom of trouser leg.

**Table 2-5. Trousers, utility
(Finished Measurements)**

WAIST SIZE	1/2 WAIST	INSEAM LENGTH				
24	12	27	29			
26	13	25	27	29	31	33
28	14	25	27	29	31	33
30	15	25	27	29	31	33 35
32	16	25	27	29	31	33 35
34	17		27	29	31	33 35
36	18			29	31	33 35
38	19				31	33 35
40	20				31	33
42	21				31	33
44	22					33
46	23					33
Tolerance	+ 1/2	-----+ 1-----				

2-6. WORKMANSHIP

All work shall be accomplished by personnel skilled in the particular trade applicable to their duties. Darning shall be neatly accomplished and patches shall be of the proper size and firmly stitched to the garments. Stitching and reseaming shall be secure and loose ends shall be turned and removed. Buttons, buckles, and belt loops shall be securely and properly attached and function as intended. The finished items shall be complete and well repaired, thoroughly cleaned, and free from all defects which may affect serviceability or general appearances.

2-7. INSPECTION

The inspection or quality control unit is responsible for determining compliance with repair instructions and requirements for classification. In process inspection will be performed for quality of workmanship and correct application of repair procedures. The completed item will be inspected for serviceable condition and appearance to insure against return of a sub-standard product to supply channels.

Section III. MATERIALS

SMR CODE	NATIONAL STOCK NUMBER	DESCRIPTION	UNIT OF ISSUE
PAFZZ	8305-01-033-4410	Cloth, Twill, Olive Green 507, MIL-C-43791, Type II	YD
PAOZZ	8315-00-899-0029	Button, Sewing Hole, Green 62016, V-B-871 Type II, Class D, Style 26	GR
PAFZZ	8310-00-262-0094	Thread, Gimp Cotton; Olive Drab 66022, V-T-280, Type II	YD
PAOZZ	8310-01-066-0973	Thread, Cotton-Covered, Polyester, Olive Drab 66022, MIL-T-43538	SL
PAFZZ	8315-00-935-6444	Tape, Textile Cotton; Green 107, MIL-T-43566, Type I, Class 3	YD
PAFZZ	8315-00-267-3125	Braid, Textile, Cotton; Green 107, MIL-B-371, Type IV, Class 2	YD
PAFZZ		Fastener, Slide, Interlocking, V-F-106, Type I, Style I, Size M	AR
PAOZZ	7290-00-634-2010	Flat-iron, Electric, 120 Volts 60 Cycle AC Current, A-A-632	EA

CHAPTER 3

**MAINTENANCE OF THE ARMY AVIATION AND COMBAT VEHICLE CREWMEMBER'S
(CVC) HIGH TEMPERATURE AND FIRE RETARDANT CLOTHING**

Section I. INTRODUCTION

3-1. SCOPE

NOTE

Army maintenance concept for coverall, CWU-27P, Flight Gloves; Flyer's Shirt, Hot Weather; Flyer's Trousers, Hot Weather; Flyer's Jacket, Lightweight (MIL-J-43923 (GL)), and Flyer's Jacket, Cold Weather (MIL-J-43924 (GL)) differs from Air Force maintenance concept found in joint Air Force/Army Publication TO 14P3-1-112/ TM 10-8400-203-13 Instructions in this chapter take precedence over those in TO 14P3-1-112/TM 10-8400-202-13 for Army users.

This chapter provides instructions covering the description, inspection, cleaning, repair maintenance, and materials of the following items.

- Coverall, CWU-27P
- Flight gloves
- Gloves, CVC summer
- * Flyer's shirt, hot weather
- * Flyer's trousers, hot weather
- * Flyer's jacket, lightweight (MIL-J-43923 (GL))
- Flyer's jacket, cold weather (MIL-J-43924 (GL))
- Coverall, CVC
- Liner, CVC Coverall
- Overall CVC

These items contain "NOMEX" fabric that is a high-temperature resistant and inherently flame retardant synthetic fabric with no-hot-melt point or drip characteristics The fabric is light in weight, will not support combustion, but will begin to char at 700° to 800°F (371° to 427°C) The fabric has good abrasion resistance similar to nylon and is also non-absorbant like nylon and other synthetic fabrics The fabric may be either aramid or novoloid fibers.

3-2. SPECIFICATIONS

SPECIFICATION	ITEM
MIL-C-83141	CWU-27P Coverall
MIL-G-81188	GS/FRP-2 Flight Gloves
MIL-G-44108	Gloves, Combat Vehicle Crewmember's, Summer
MIL-S-43686	* Shirt, Hot Weather
MIL-T-43688	* Trousers, Hot Weather
MIL-J-43923 (GL)	* Jacket, Lightweight
MIL-J-43924 (GL)	* Jacket, Cold Weather
MIL-C-44077	Coverall, Combat Vehicle Crewmember's
MIL-L-44299	Liner, Combat Vehicle Crewmember's Coverall
MIL-O-44109	Overall, Combat Vehicle Crewmember's

* Also used by Combat Vehicle Crewmembers (CVC) Air crews are not authorized to use the shirt and trousers.

3-2. SPECIFICATIONS-Continued

Specifications for components of these items may be found in section III of this chapter.

3-3. TECHNICAL PUBLICATIONS

NUMBER	TITLE
Fed. Std. 751 FM 10-280	Stitches, Seams, and Stitching. Field Laundry, Bath, and Clothing Exchange Operations

3-4. IDENTIFICATION AND DESCRIPTION OF ITEMS

Front and back views of the coverall, gloves, shirt, trousers, lightweight jacket, and cold weather jacket are shown in figures 3-1, 3-2, 3-3, 3-4, and 3-5.

3-4. IDENTIFICATION AND DESCRIPTION OF ITEMS-Continued

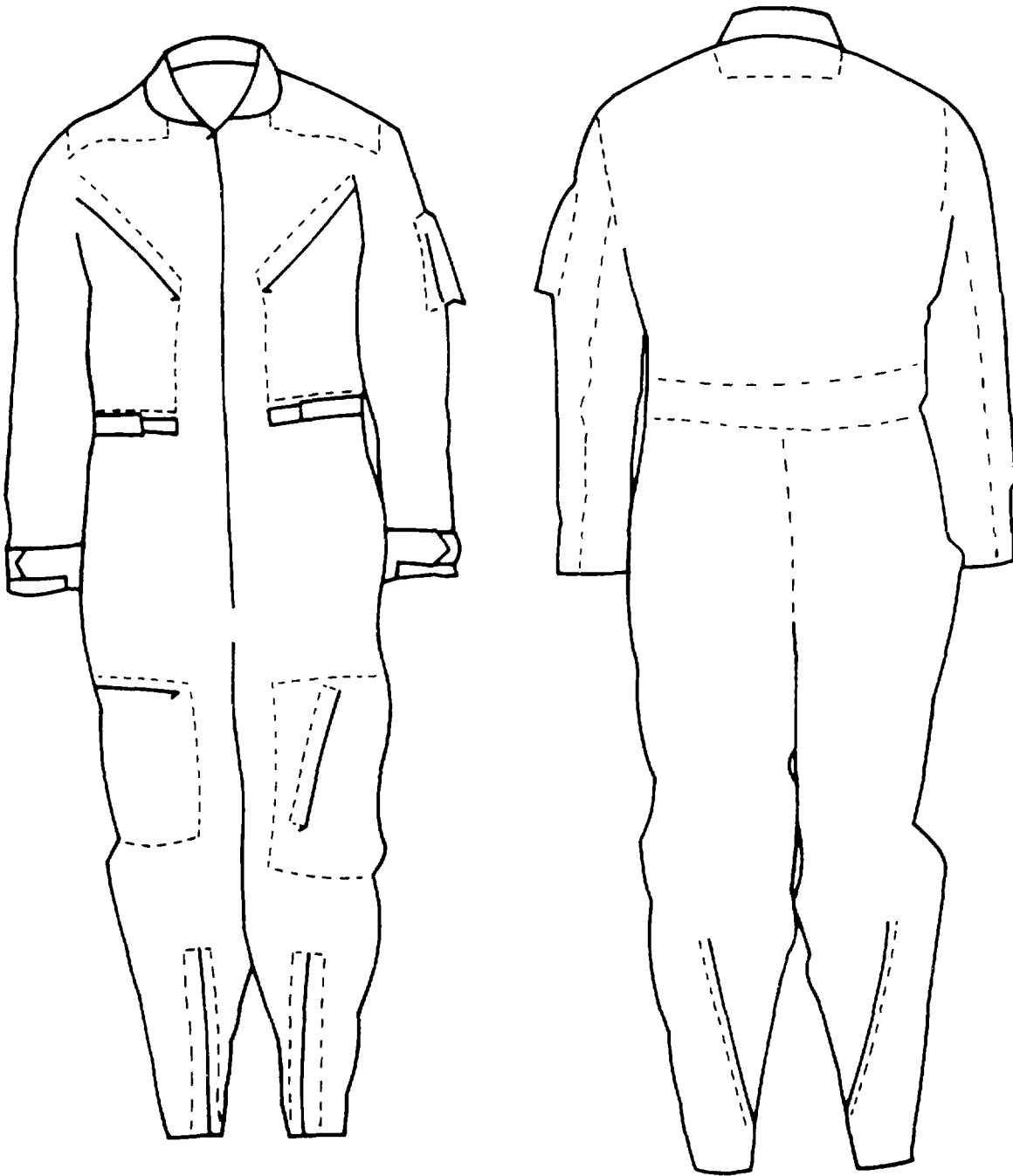
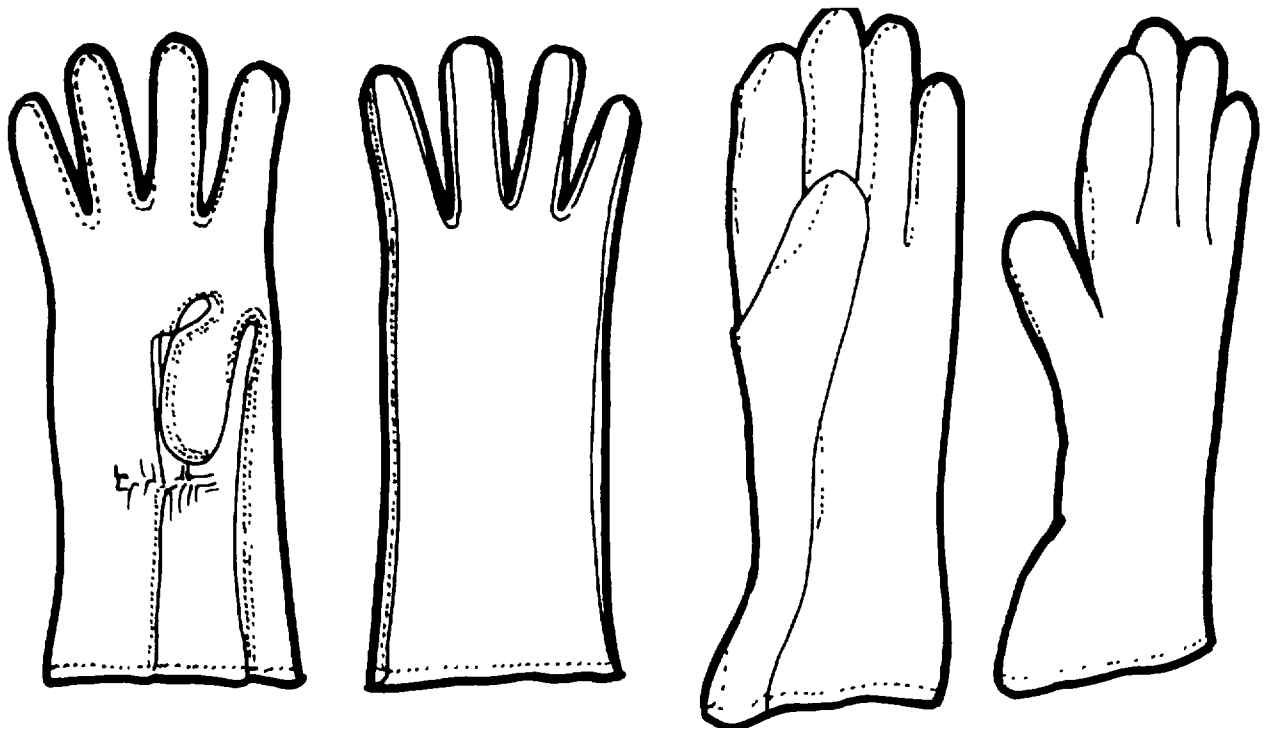

Figure 3-1. CWU-27P Coverall, front and back.

3-4. IDENTIFICATION AND DESCRIPTION OF ITEMS-Continued



COMBAT VEHICLE CREWMEMBERS'
(CVC) SUMMER GLOVES

SG/FRP FLIGHT GLOVES

*Figure 3-2. GS/FRP Flight Gloves and Combat Vehicle
Crewmembers' Summer Gloves, Front and Back.*

3-4. IDENTIFICATION AND DESCRIPTION OF ITEMS-Continued

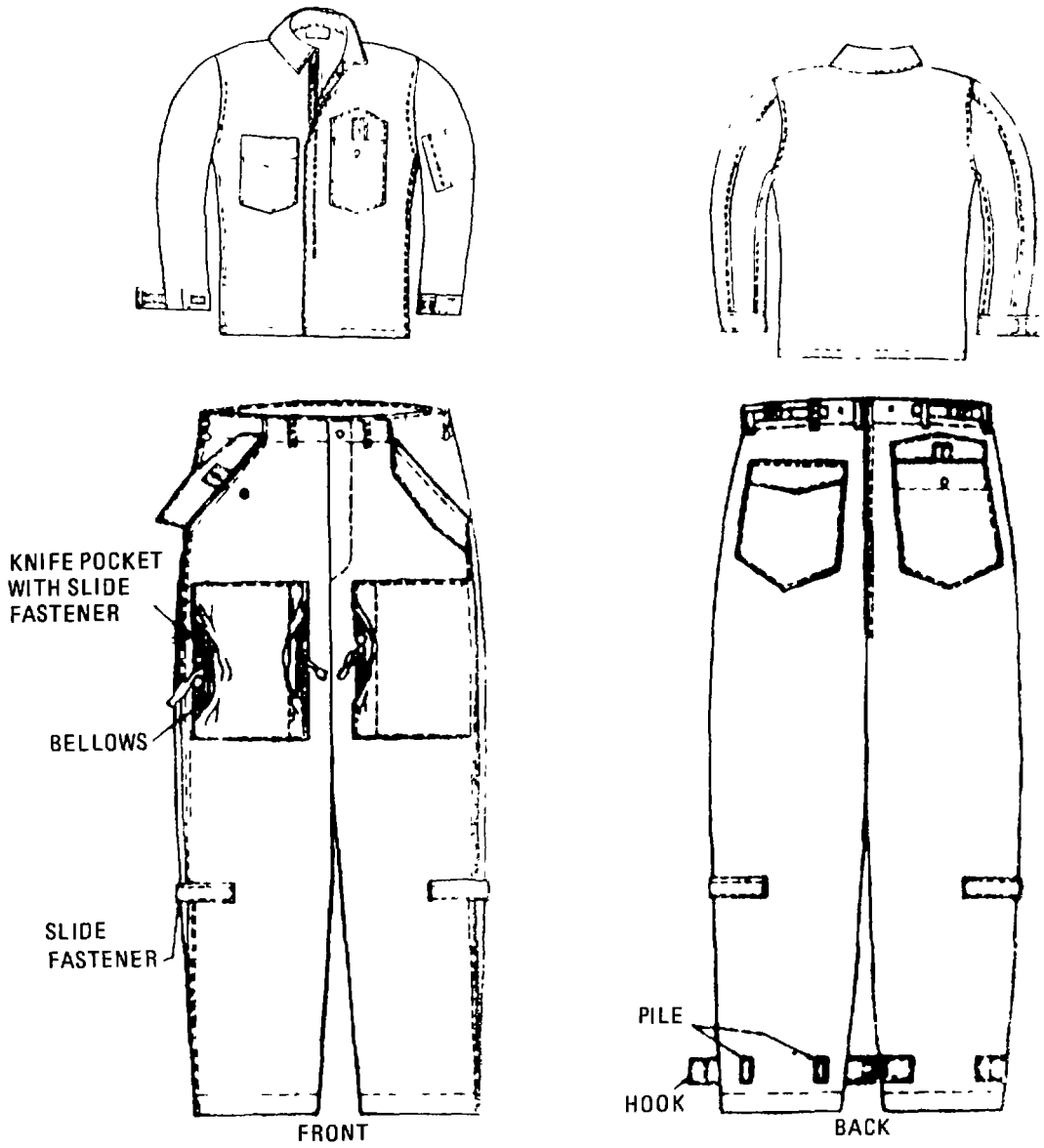

*Used by Combat Vehicle Crewmembers
Figure 3-3. Shirt and Trousers, front and back.*

3-4. IDENTIFICATION AND DESCRIPTION OF ITEMS-Continued

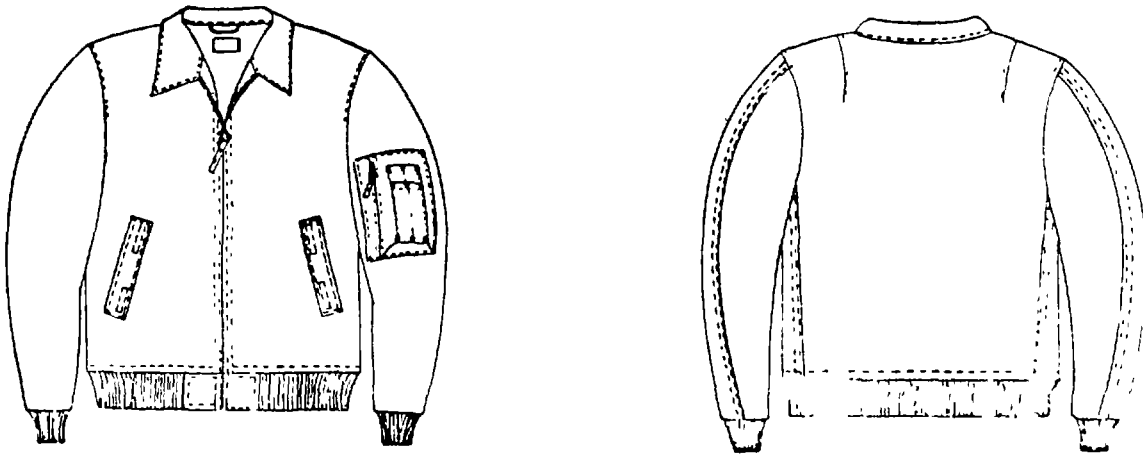
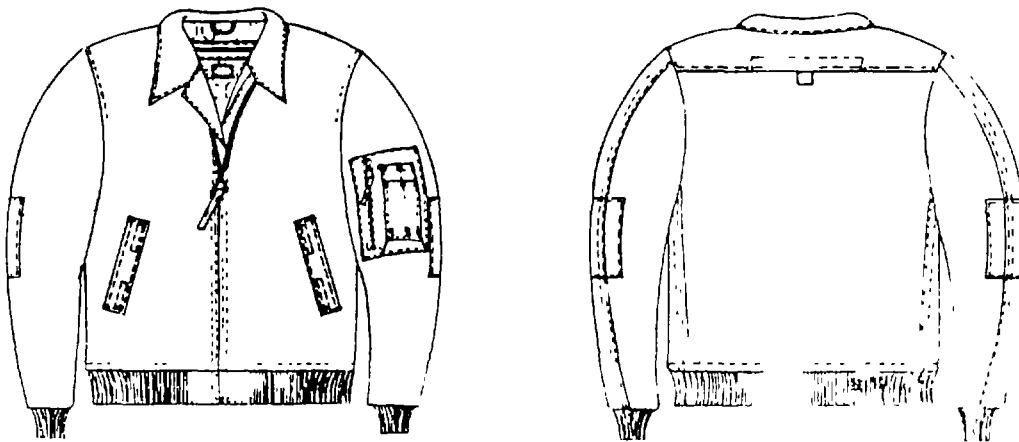

Figure 3-4. Lightweight Jacket, front and back.



Used by Aviation and Combat Vehicle Crewmembers
Figure 3-5. Cold Weather Jacket, front and back.

3-4. IDENTIFICATION AND DESCRIPTION OF ITEMS-Continued

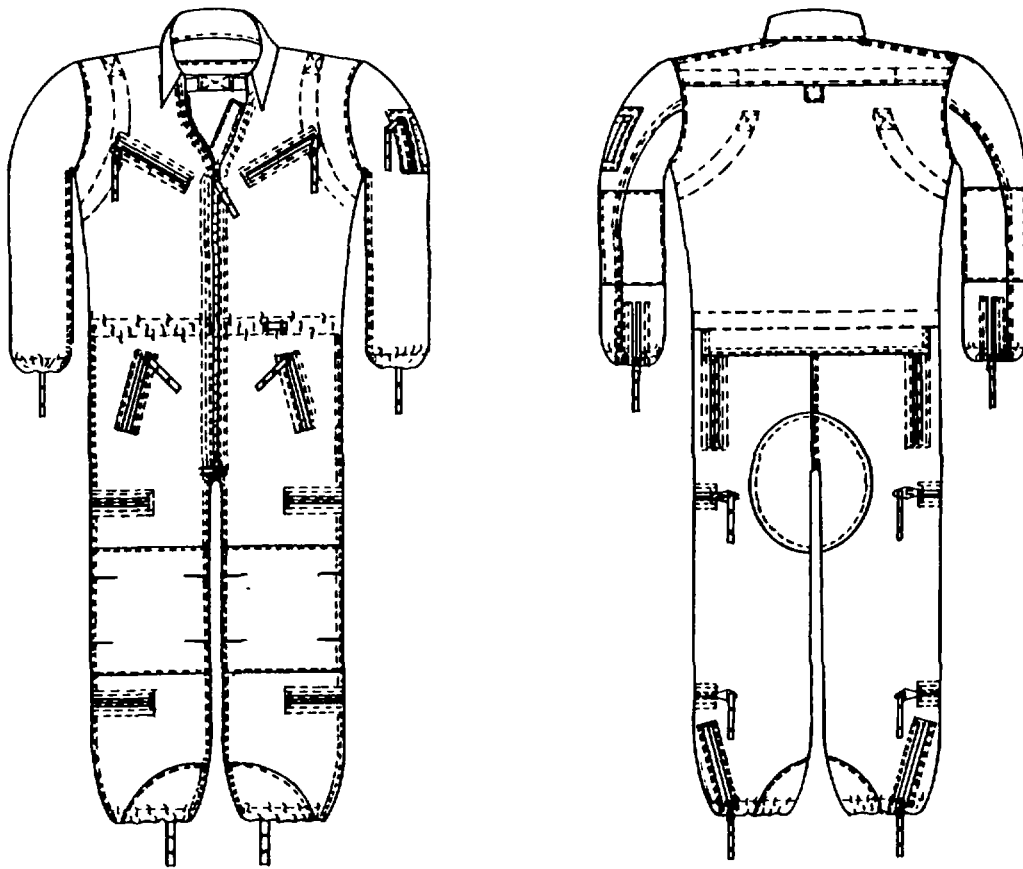
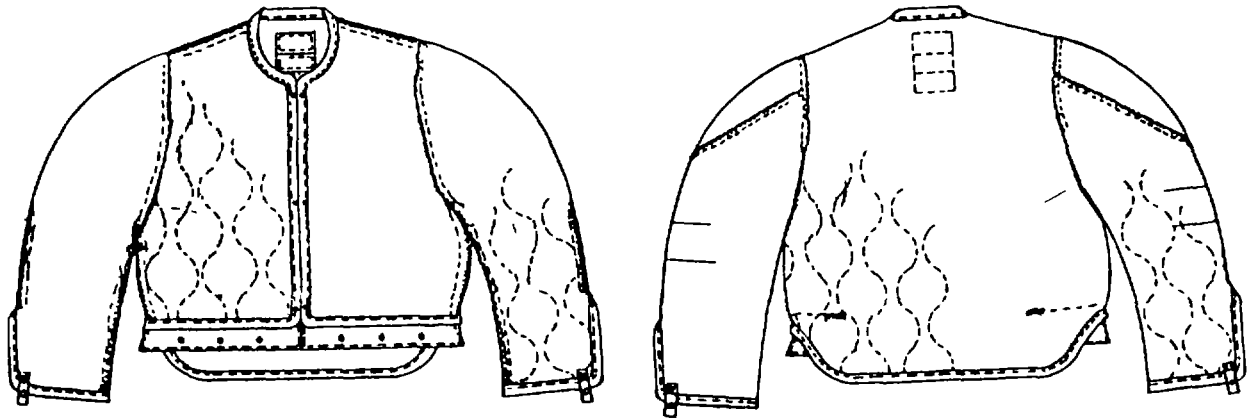
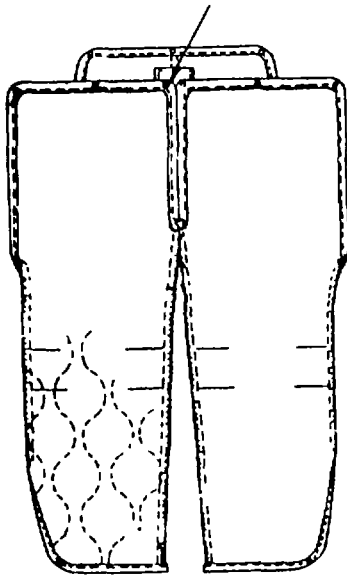

Figure 3-6. Coverall Combat Vehicle Crewmember's.

3-4. IDENTIFICATION AND DESCRIPTION OF ITEMS-Continued



COMBINATION SNAP FASTENER



FRONT

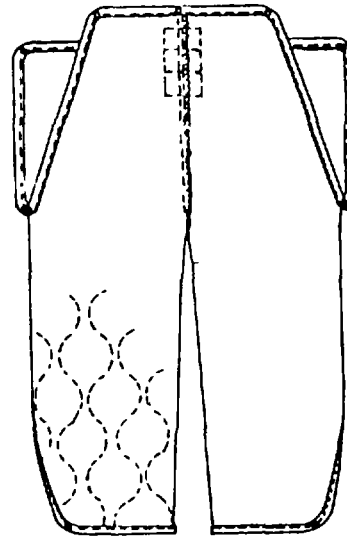

BACK

Figure 3-7. Liner, Combat Vehicle Crewmember's Coveralls, Cold Weather

3-4. IDENTIFICATION AND DESCRIPTION OF ITEMS-Continued

Figure 3-8. Overall, Combat Vehicle Crewmember's

3-5. COVERALL, CWU-27/P and CVC.

a. Coverall, CWU-27/P and CVC.

- (1) COVERALL, TYPES CWU-27/P (SAGE GREEN), MIL-C-83141 (fig 3-1). The coverall is a one piece, unlined garment with a slide fastener front closure and side pass-throughs, a bi-swing back, hook and pile fastener tape size adjustments for the waist and sleeves, and a slide fastener size adjustment on each leg terminal. Also included are two breast patch pockets, one combination cigarette pack and multiple pencil compartment on the upper front left sleeve, two thigh and a multiple pencil compartment pocket on the right lower leg patch pocket. Except for the knife pocket on the left thigh and the multiple pencil compartment pocket on the right lower leg, all pockets and pass-throughs have butted-beaded covered slide fasteners. (See figure 3-1).

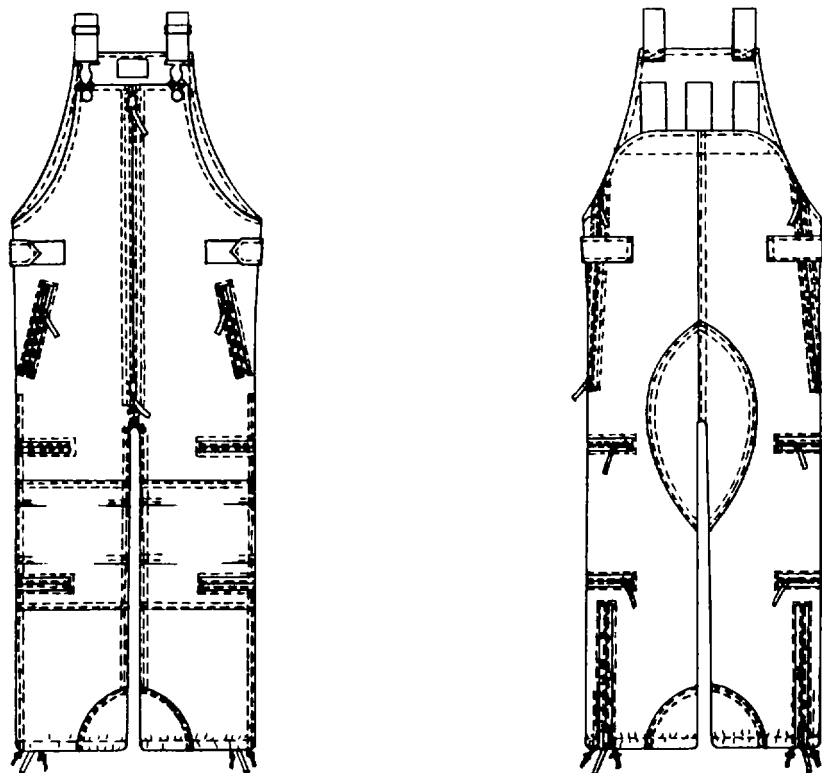
NOTE

The knife pocket is to accommodate the MC-1 knife. The knife should be tied to the pocket cord and stowed in the pocket with the hook blade open for emergency use. The cord shall be wrapped around the knife to prevent accidental opening of switch blade. Stowage of MC-1 knife should always be in outer garment, such as survival vest (location is a command option).

- (2) COVERALL, COMBAT VEHICLE CREWMEMBER'S, MIL-C-44047 (fig. 3-6). The coverall features a drop seat with slide fastener closure at sides and hook-and-pile tape at top edge; a retrieval strap (loop), located at a hook-and-pile closure at lower end of back yoke; elastic at sleeve and leg bottoms; slide fastener side opening, an elastic waist tunnel; and neck tab. There are nine pockets having slide fastener openings and welt pieces. two chest patch types; two front inside hanging; two thigh inside hanging, two shin inside hanging; and a left sleeve utility pocket.

- b. The coveralls contain an anti-static finish and are furnished in twenty different sizes for the CWU-27/P coverall (table 3-17) and fifteen different sizes for the CVC coverall (table 3-8).

NOTE

Individuals who cannot be fitted properly by using standard sized coveralls may obtain special fitting in accordance with AR 32-4 Special Measurement Clothing.

- c. In order to assure maximum fire protection, the sleeves of the coverall shall always be closed at the wrists. The sleeves have been designed so that it is very difficult, and sometimes impossible, to roll up the sleeves.
- d. Because of the non-absorbent characteristic of the coverall, cotton, wool or a cotton/wool blend of fibers underwear should be worn under the coverall for optimum comfort, and fire/heat protection.

WARNING

The coveralls are not fireproof and will char at about 700° to 800° F (370° to 430°C); therefore, ground egress procedures cannot be overemphasized.

3-6. FLIGHT GLOVES AND COMBAT VEHICLE CREWMEMBER (CVC) GLOVES

- a. FLIGHT GLOVES AND CVC GLOVES are of the same design consisting of leather for the palm which extends through the gauntlet, and fabric for the remainder of the glove. The two gloves differ in the type of leather used for the palm areas. Flight gloves are constructed of gray sheepskin with non-slip qualities CVC gloves are constructed from perspiration/water resistant black cattlehide. The fabric portions of both gloves are high temperature resistant polyamide, simplex knit, green. This fabric is inherently flame retardant and has no hot-melt or drip characteristics. The fabric will not support combustion but will begin to char at 700° to 800°F (371 ° to 427°C) (fig. 3-2).
- b. SIZE AND FIT Flight gloves are available in six sizes and CVC gloves in seven sizes (see Section II of this chapter) Both gloves are designed to permit a snug fit and to provide sufficient dexterity and tactility to not interfere with the operation of the aircraft or combat vehicle, manipulation of switches, and safety or parachute harness buckles. To fit properly, the gloves should be neither too tight nor too loose around your hand, and the ends of your fingers should reach the ends of the glove fingers.

3-7. SHIRT AND TROUSERS

- a. Shirt, flyer's (*), hot weather, fire retardant, single breasted, olive green shade 106, specification MIL-S-43686. This item is fabricated of cloth, twill, nylon, high temperature resistant, shade olive green 106, conforming to type I of MIL-C-43600. The shirt material protects the wearer against high intensity flame It provides valuable protection against flash fires The shirt has two breast pockets and a left sleeve pocket for pencils, penlight, and cigarettes. The front of the shirt has a slide fastener closure (fig 3-3).
- b. Trousers, flyer's (*), hot weather, fire retardant. The hot weather trousers are made from cloth, twill, nylon, high temperature resistant. The trouser pockets are located at the front, hip, and shin areas and adequately accommodate maps. Tabs are located on the leg bottom for blousing the trousers (fig 3-3).

WARNING

The shirt and trousers are not fireproof and will char at about 700° to 800°F (370° to 430°C); therefore egress procedures cannot be over emphasized.

3-8. FLYER'S JACKET

- a. The Jacket, Flyer's, Lightweight, Expandable Wrists and Waist, Fire Retardant, Single Breasted, Olive Green, Shade 106, Specification MIL-J-43923(GL). This item is fabricated of cloth, 6 0 ounce (170 g) high temperature resistant, non-melting nylon oxford, shade Olive Green 106, conforming to MIL-C-43842. The Jacket material is of low flammability and worn by aviation and combat vehicle crewmen as outer garment during ground and In-flight operations. The Jacket has a front slide fastener closure. Jacket has a collar with tab closure and diagonal side pocket welts with hook and pile closure. The left sleeve has a cigarette and pencil pocket. The cuffs and waistband are rib knit. Jacket is fully self-lined (see fig 3-4).

* Unauthorized aircrews are not to use the shirt and trousers.

3-8. FLYER'S JACKET-Continued

b. The Jacket, Cold Weather, Expandable Wrists and Waist, Fire Retardant, Single Breasted, Olive Green Shade 106, Specification MIL-J-43924 (GL). This item is fabricated of cloth, 6.0 ounce (170 g) high temperature resistant, non-melting nylon oxford, shade olive green 106, conforming to MIL-C-43842. The Jacket material is of low flammability and worn by aviation and combat vehicle crewmen as outer garment during ground and in flight operations. The Jacket has a front slide fastener closure with an inside protective flap. Jacket has a collar with tab closure and has diagonal side pocket welts with hook and pile closure. The left sleeve has a cigarette and pencil pocket. The cuffs and waistband are rib knit. Jacket is fully lined with quilted batting material (see fig. 3-5).

WARNING

The jackets are not fireproof and will begin to char at about 700° to 800°F (370° to 430° C); therefore, degrees cannot be overemphasized.

3-9. LINER, CVC COVERALL

The Liner, Coat and Trouser for the Coverall, Combat Vehicle Crewmember's Olive Green Shade 106, Specification MIL-L-44299. It is fabricated of quilted, high temperature resistant, non-melting nylon batting, shade OG-106, conforming to MIL-B-81813. The liner material is of low flammability and is worn by Combat Vehicle Crewmembers as an insulating layer under the coverall. The liner consists of separate coat and trouser components secured together by snap fasteners.

WARNING

The liners are not fireproof and will begin to char at about 700° to 800°F (370° to 430° C); therefore, egress cannot be overemphasized.

3-10. OVERALL, CVC

Overall, Combat Vehicle Crewmember's, Olive Green 106, specification MIL-0-44109. The overall is fabricated of cloth, 6.0 ounce, high temperature resistant, non-melting nylon oxford, shade Olive Green 106, conforming to MIL-C-43842. The overall material is of low flammability and worn by Combat Vehicle Crewmembers as an outer garment during cold weather operations. The overall has: a bib front with a center front slide fastener extending to the crotch; a drop seat, adjustable suspenders; and leg opening slide fasteners. The overalls have an integrated liner that extends above the waist level in the front and back. All pockets have slide fastener closures and are located at the left and right front hips, right and left upper thighs and right and left lower legs.

WARNING

The overall is not fireproof and will begin to char at about 700° to 800°F (370° to 430° C); therefore, egress cannot be overemphasized.

Section II. REPAIR PROCEDURES

3-11. MATERIALS

Materials used in repair shall be serviceable materials recovered from similar salvaged items or new material. New materials will be requisitioned from stock under the stock numbers and/or item descriptions in Section III, Materials, and shall conform to the appropriate specifications. DO NOT USE SUBSTITUTE MATERIALS.

3-12. REPAIR AND MAINTENANCE

Prior to repair operations, each item shall be inspected by qualified personnel to determine the amount of repair necessary. The following methods shall be observed as fully as skills, facilities, funds, and local conditions permit. The sequence of operations shall be determined by the repairing organizations, unless otherwise prescribed.

a. Organizational repair. The following repair will be accomplished by hand or by organized maintenance.

- (1) Inspect. Inspect all subject items to determine the amount of repairs needed and whether such repairs can be accomplished within the organization.
- (2) Cleaning. The individual will clean the item to be turned in for repair or replacement. Cleaning of the Item will be done in accordance with paragraph 3-15.
- (3) Buttons. Replace missing or damaged buttons.
- (4) Repair.
 - (a) Re-sew or patch rips, tears, and loose seams.
 - (b) Re-sew torn out buttonholes and slide fasteners and attach all belt loops that are torn loose.

b. Direct Support Maintenance.

- (1) Inspection. Preliminary examination and cleaning-dirt, mud, dust, spots, mildew stains and other foreign matter shall be removed by laundering. Mildewy and rotten items shall be discarded. Seams shall be tested by grasping the item with both hands and pulling at right angles to the seam. Areas to be repaired shall be marked with chalk. Nonspecification and personnel marks shall be erased or obscured.
- (2) Cleaning. Items shall be processed in laundry facilities in accordance with Formula 1, FM 10-280. When such facilities are not available, Items shall be laundered by contract with private industry but strictly in accordance with the above listed formula.
- (3) Repair
 - (a) Patching.

3-12. REPAIR AND MAINTENANCE-Continued**CAUTION**

Do Not Use Substitute Thread. Do Not Use Iron-On Patches For Repairs.

Garments may be patched using stitched patches and non-melting nylon thread, size E, NSN 8310-00-492-8397.

(b) Stitching and restitching. When possible all sewing shall be machine sewn. Regulate the number of stitches as cited in table 3-1. The thread tension shall be adjusted so that there will be no loose stitching or excessively tight stitching resulting in puckering of the material sewn. When ends of machine stitching type 301 are not caught in other seams or stitching, they shall be back-stitched not less than 1 inch. Ends of a continuous line of stitching shall overlap not less than 1/2 inch (1.27 cm). Thread breaks shall be repaired by stitching back over the break not less than 1/2 inch (1.27 cm). Thread tension shall be properly maintained to avoid loose stitching and locks shall be embedded in the center of the material sewn. Thread breaks in overedge stitching shall be overlocked not less than 3/4 inch (1.91 cm) at each break. Stitch spacing used on new replacement section, resitching, and types of seams shall be the same as in the original construction. Seams with loose and/or weak thread shall be restitched. For illustrations of the various types of stitches used, see FED-STD-751. The following types of stitch, thread size, and stitches per inch are to be used as applicable to the repair.

Table 3-1. Stitching Instructions

ITEM NO.	LOCATION	STITCH TYPE	THREAD		STITCHES PER INCH
			NEEDLE	BOBBIN	
1 and 2	General	301	E	E	10-12
1 and 2	General	401	E	E	10-12
1 and 2	Overedge Stitching	502 503 504	E	E	6-10
	Safety Stitch	515 516 519	E	B	10-12
1 and 2	* Bartacks	Bartacks	E	E	18 per bartack
1 and 2	* Buttonholes	Buttonholes	E	E	44-46 per buttonhole
1 and 2	Buttons	101 or 301	E E	-	20-24 per button

* May be repaired by hand using double ply of E thread.

3-12. REPAIR AND MAINTENANCE-Continued

- (c) Patching and darning. Patching and darning may be applied to any area of the garment. Repair small tears not more than 1/2 inch (1.27 cm) across with a darning or zigzag stitch. Patch holes with a patch having a diameter of 1/2 Inch (1.27 cm) but less than 4 inches (10.2 cm). Repair rips, tears and thin areas greater than 1/2 inch (1.27 cm) but less than 4 inches (10.2 cm) by patching. Patches shall match the garment in color and type of material. Insert patch under the damaged area, cut away damaged area and turn edges under approximately 1/4 inch (0.635 cm). Cut patch large enough to extend not less than 1/2 inch (1.27 cm) and not more than 1 Inch (2.54 cm) around the perimeter of the opening with a 3/8 inch (0.953 cm) turn-under of all edges except selvage edges. Pre-cut all patches to provide for symmetry. Replace defective flaps except those flaps with very small holes that can be darned. Materials shall be those as specified in section III.
 - (d) Buttons. Replace missing, loose or damaged buttons with buttons conforming to those listed in section III as applicable. Attach the buttons securely and aligned with eyelet end of respective buttonholes
 - (e) Buttonholes. Buttonholes shall be of the eyelet-end-taper-bar type worked over gimp. Repair damaged buttonholes by reshaping enlarged buttonholes before reworking. Then pull buttonhole into shape and hand or machine whip a small reinforcement patch to the underside of the buttonhole. Then rework buttonhole through the patch.
 - (f) Belt loop. Replace missing, broken or torn belt loops with new parts of matching size and material. Such parts shall be fastened in a like manner to those being replaced and shall be properly positioned.
 - (g) Pockets. Darn or machine patch small holes, small rips at corners, and broken seams of pockets. Replace damaged patch pockets with new pocket of matching material and design. Inside hanging pockets shall be repaired by piecing, when required
 - (h) Hems. Turn under all frayed hems and stitch in place.
 - (i) Waistband adjusting straps. Replace missing or damaged waistband straps with new parts of like size and design.
 - (j) Buckles. Replace missing, broken, or damaged buckles with like buckles in size and type specified in section III.
 - (k) Slide fasteners. Replace missing or defective slide fasteners with parts conforming to the type specified in section III.
- (4) Resizing. Resize all garments after complete repair and cleaning according to the item group schedule of sizes listed in tables 3-2 through 3-6. When items deviate in size from their original marking, obliterate the old marking and print or stamp the proper size with an indelible pencil or waterproof ink near the old size. When the measurements do not correspond to a size listed, remark the items to correspond to the next lowest size. Items with measurements falling below the lowest measurement in the schedule will not be accepted as conditioned.

3-12. REPAIR AND MAINTENANCE-Continued

Table 3-2. FLYERS SHIRT

Sizing instructions and finished measurements (in inches)

SHIRT PARTS	SHORT	REGULAR	LONG	NATIONAL STOCK NUMBERS	
HALF CHEST ¹				Shirt Size	NSN
X-Small	20 1/4	20 1/4	20 1/4	X-Small Short	8415-00-935-4891
Small	22 1/4	22 1/4	22 1/4	X-Small Regular	8415-00-935-4892
Medium	24 1/4	24 1/4	24 1/4	Small Short	8415-00-935-4894
Large	26 1/4	26 1/4	26 1/4	Small Regular	8415-00-935-4895
X-Large	28 1/4	28 1/4	28 1/4	Small Long	8415-00-935-4896
BACK LENGTH ²				Medium Short	8415-00-935-4897
X-Small	26 3/4	27 3/4	28 3/4	Medium Regular	8415-00-935-4898
Small	27 3/4	28 3/4	29 3/4	Medium Long	8415-00-935-4899
Medium	28 3/4	29 3/4	30 3/4	Large Short	8415-00-935-4900
Large	29 3/4	30 3/4	31 3/4	Large Regular	8415-00-935-4901
X-Large	30 3/4	31 3/4	32 3/4	Large Long	8415-00-935-6200
SLEEVE LENGTH ³				X- Large Short	8415-00-935-6201
X-Small	22 1/2	23 1/2	24 1/2	X-Large Regular	8415-00-935-6202
Small	23	24	25	X-Large Long	8415-00-935-6203
Medium	23 1/2	24 1/2	25 1/2		
Large	24	25	26		
X-Large	24 1/2	25 1/2	26 1/2		

¹Half chest: Shirt front closed, at base of armhole from folded edge \pm 3/4-inch tolerance.²Back length: At center of back, from collar seam to bottom of shirt \pm 1/2-inch tolerance.³Sleeve length: Along center of top sleeve from top of sleeve to bottom edge of cut \pm 1/4-Inch tolerance.

3-12. REPAIR AND MAINTENANCE-Continued

Table 3-3. Flyer's Trousers

Sizing Instructions and finished measurements (in inches)

NATIONAL STOCK NUMBER	SIZE	WAIST	INSEAM
8415-00-935-4878	X-Small-Short	Below 27 In.	Up to 29 1/2 in
8415-00-935-4879	X-Small-Regular	Below 27 in	29 1/2 to 32 1/2 in.
8415-00-935-4880	X-Small-Long	Below 27 In	Over 27 in.
8415-00-935-4881	Small-Short	From 27 in 31 in.	Up to 29 1/2 in.
8415-00-935-4882	Small-Regular	From 27 to 31 in.	29 1/2 to 32 1/2 in.
8415-00-935-4883	Small-Long	From 27 to 31 in.	Over 32 1/2 in.
8415-00-935-4884	Medium-Short	From 31 to 35 in.	Up to 29 1/2 in
8415-00-935-4885	Medium-Regular	From 31 to 35 In.	29 1/2 to 32 1/2 in.
8415-00-935-4886	Medium-Long	From 31 to 35 In.	Over 32 1/2 in.
8415-00-935-4887	Large-Short	From 35 to 39 In	Up to 29 1/2 in
8415-00-935-4888	Large-Regular	From 35 to 39 In.	29 1/2 to 32 1/2 in
8415-00-935-4889	Large-Long	From 35 to 39 In.	Over 32 1/2 in.
8415-00-935-6206	X-Large-Short	From 39 to 43 in	Up to 29 1/2 in.
8415-00-935-4890	X-Large-Regular	From 39 to 43 in.	29 1/2 to 32 1/2 in.
8415-00-935-6207	X-Large-Long	From 39 to 43 in	Over 32 1/2 in

Table 3-4. Jacket, Flyers', Lightweight

Sizing Instructions and Finished Measurements (In inches)

	SHORT	REGULAR	LONG
Half Chest (see note #1)			
X-Small	21	21	21
Small	23	23	23
Medium	25	25	25
Large	27	27	27
X-Large	29	29	29

3-12. REPAIR AND MAINTENANCE-Continued

Table 3-4. Jacket, Flyer's, Lightweight-Continued
Sizing Instructions and Finished Measurements (in Inches)

	-SHORT	REGULAR	LONG
Back Length (see note #2)			
X-Small	21 1/2	22 1/2	23 1/2
Small	22	23	24
Medium	22 1/2	23 1/2	24 1/2
Large	23	24	25
X-Large	23 1/2	24 1/2	25 1/2
Sleeve Length (see note #3)			
X-Small	14 1/4	15 1/4	16 1/4
Small	14 1/4	15 1/4	16 1/4
Medium	14 1/4	15 1/4	16 1/4
Large	14 1/4	15 1/4	16 1/4
X-Large	14 1/4	15 1/4	16 1/4

Note #1. Half Chest - Jacket front closed, at base of armhole from folded edge to folded edge. $\pm 3/4$ in. tolerance.

Note #2. Back Length - At center back, from collar joining seam to top of knit waistband. $\pm 3/4$ In tolerance.

Note #3. Sleeve Length - From armhole along underarm seam to top of cuff. $\pm 3/4$ in tolerance

3-12. REPAIR AND MAINTENANCE - Continued**Table 3-5. Jacket, Flyers', Cold Weather**

Sizing Instructions and Finished Measurements (in inches)

	SHORT	REGULAR	LONG
Half Chest (see note #1)			
X-Small	21	21	21
Small	23	23	23
Medium	25	25	25
Large	27	27	27
X-Large	29	29	29
Back Length (see note #2)			
X-Small	21 5/8	22 5/8	23 5/8
Small	22 1/8	23 1/8	24 1/8
Medium	22 5/8	23 5/8	24 5/8
Large	23 1/8	24 1/8	25 1/8
X-Large	23 5/8	24 5/8	25 5/8
Sleeve Length (see note #3)			
X-Small	13 7/8	14 7/8	15 7/8
Small	13 7/8	14 7/8	15 7/8
Medium	13 7/8	14 7/8	15 7/8
Large	13 7/8	14 7/8	15 7/8
X-Large	13 7/8	14 7/8	15 7/8

Note #1. Half Chest - Jacket front closed, at base of armhole from folded edge to folded edge. $\pm 3/4$ in. tolerance.

Note #2. Back Length - At center back, from collar joining seam to top of knit waistband. $\pm 3/4$ in. tolerance.

Note #3. Sleeve Length - From armhole along underarm seam to top of cuff. $\pm 3/4$ in. tolerance.

3-12. REPAIR AND MAINTENANCE - Continued

Table 3-6. Jacket, Flyer's

National Stock Numbers

SIZE	CHEST	HEIGHT	COLD WEATHER		LIGHTWEIGHT
			STD A	STD B	
X-Small Short	Up to 33 in.	Up to 67 in.	8415-01-074-9413	8415-00-221-8870	8415-00-217-7201
X-Small Regular	Up to 33 in.	67 to 71 in.	8415-01-074-9414	8415-00-221-8873	8415-00-217-7207
X-Small Long	Up to 38 in.	71 inches up	8415-01-074-9415	8415-00-221-8874	8415-00-217-7208
Small Short	27 to 33 in.	Up to 67 in.	8415-01-074-9416	8415-00-221-8879	8415-00-217-7210
Small Regular	33 to 37 in.	67 to 71 in.	8415-01-074-9417	8415-00-221-8884	8415-00-217-7212
Small Long	33 to 37 in.	71 inches up	8415-01-074-9418	8415-00-221-8886	8415-00-217-7213
Medium Short	37 to 41 in.	Up to 67 in.	8415-01-074-9419	8415-00-221-8920	8415-00-217-7219
Medium Regular	37 to 41 in.	67 to 71 in.	8415-01-074-9420	8415-00-217-7387	8415-00-217-7220
Medium Long	37 to 41 in.	71 inches up	8415-01-074-9421	8415-00-217-7391	8415-00-217-7221
Large Short	41 to 45 in.	Up to 67 in.	8415-01-074-9427	8415-00-217-7400	8415-00-217-7226
Large Regular	41 to 45 in.	67 to 71 in.	8415-01-074-9422	8415-00-217-7401	8415-00-217-7229
Large Long	41 to 45 in.	71 inches up	8415-01-074-9423	8415-00-217-7402	8415-00-217-7233
X-Large Short	45 inches up	Up to 67 in.	8415-01-074-9424	8415-00-217-7422	8415-00-217-7234
X-Large Regular	45 inches up	67 to 71 in.	8415-01-074-9425	8415-00-217-7423	8415-00-217-7235
X-Large Long	45 inches up	71 inches up	8415-01-074-9426	8415-00-217-7424	8415-00-217-7236

3-12. REPAIR AND MAINTENANCE - Continued

Table 3-7. Coverall, Combat Vehicle Crewmembers's

Sizing Instructions and Finished Measurements (in inches)

Size	Short	Regular	Long	Tolerance
HALF CHEST ¹				
X-SMALL	20 1/2	20 1/2	20 1/2	±1/2
SMALL	22 1/2	22 1/2	22 1/2	
MEDIUM	24 1/2	24 1/2	24 1/2	
LARGE	26 1/2	26 1/2	26 1/2	
X-LARGE	28 1/2	28 1/2	28 1/2	
SLEEVE LENGTH ²				
X-SMALL	18 1/2	19 1/2	20 1/2	±1/2
SMALL	18 1/2	19 1/2	20 1/2	
MEDIUM	18 1/2	19 1/2	20 1/2	
LARGE	18 1/2	19 1/2	20 1/2	
X-LARGE	18 1/2	19 1/2	20 1/2	
INSEAM ³				
X-SMALL	28	30	32	±1/2
SMALL	28	30	32	
MEDIUM	28	30	32	
LARGE	28	30	32	
X-LARGE	28	30	32	

¹Measure from folded edge to folded edge at bottom of armhole²Measure from base of armhole to bottom edge of sleeve. Individual coverall sleeve shall not differ in length by more than 1/2 inch.³Measure from seal line at base of crotch to bottom of leg. Individual coverall inseams shall not differ in length by more than 1/2 Inch.**Table 3-8. National Stock Numbers for Coverall, CVC**

SIZE	NSN
X-Small-Short	8415-01-074-6208
X-Small-Regular	8415-01-074-9438
X-Small-Long	8415-01-074-7020
Small-Short	8415-01-074-6254
Small-Regular	8415-01-074-6255
Small-Long	8415-01-074-7021
Medium-Short	8415-01-074-6256
Medium-Regular	8415-01-074-6257
Medium-Long	8415-01-074-7022
Large-Short	8415-01-074-7023
Large-Regular	8415-01-074-7024
Large-Long	8415-01-074-6209
X-Large-Short	8415-01-074-9439
X-Large-Regular	8415-01-074-6210
X-Large-Long	8415-01-074-6211

3-12. REPAIR AND MAINTENANCE - Continued

Table 3-9. Liner, Coverall, Combat Vehicle Crewmember's,
Sizing Instructions and Finished Measurements (in inches)

x	SHORT	REGULAR	LONG
Coat:			
Half Chest ¹			
X-Small	21	21	21
Small	23	23	23
Medium	25	25	25
Large	27	27	27
X-Large	29	29	29
Tolerance $\pm 3/4$			
Sleeve Inseam ²			
X-Small	17	18	19
Small	17	18	19
Medium	17	18	19
Large	17	18	19
X-Large	17	18	19
Tolerance $\pm 1/2$			
Trousers:			
Half Waist ³			
X-Small	18	18	18
Small	20	20	20
Medium	22	22	22
Large	24	24	24
X-Large	26	26	26
Tolerance $\pm 1/2$			
Leg Inseam ⁴			
X-Small	23	25	27
Small	23	25	27
Medium	23	25	27
Large	23	25	27
X-Large	23	25	27
Tolerance $\pm 1/2$			

¹With liner snapped measure across front at base of armhole from folded edge to folded edge.

²Measure Inseam from underarm opening to bottom of sleeve.

³Coat: With liner snapped measure across waist at binding from folded edge to folded edge.

Trouser: Measure from edge to edge across each trouser front and back just below binding and divide total by two.

⁴Measure inseam from crotch opening to bottom of leg.

3-12. REPAIR AND MAINTENANCE - Continued

Table 3-10. National Stock Numbers for Liner, Coverall, CVC

Size	Coat Liner	Trouser Liner
X-Small-Short	8415-01-110-1397	8415-01-110-4456
X-Small-Regular	8415-01-110-1398	8415-01-110-4457
X-Small-Long	8415-01-110-1399	8415-01-110-4458
Small-Short	8415-01-110-1400	8415-01-110-4459
Small-Regular	8415-01-110-1401	8415-01-110-4460
Small-Long	8415-01-110-1402	8415-01-110-4461
Medium-Short	8415-01-110-1403	8415-01-110-4462
Medium-Regular	8415-01-110-1404	8415-01-110-4463
Medium-Long	8415-01-110-1405	8415-01-110-4464
Large-Short	8415-01-110-1406	8415-01-110-4465
Large-Regular	8415-01-110-1407	8415-01-110-4466
Large-Long	8415-01-110-1408	8415-01-110-4467
X-Large-Short	8415-01-110-1409	8415-01-110-4468
X-Large-Regular	8415-01-110-1410	8415-01-110-4469
X-Large-Long	8415-01-110-1411	8415-01-110-4470

3-12. REPAIR AND MAINTENANCE - Continued

Table 3-11. Overall, Combat Vehicle Crewmember's
Sizing Instructions and Finished Measurements (in inches)

	X-Small	Small	Medium	Large	X-Large	Tolerance
Half Waist ¹	19 3/4	21 3/4	23 3/4	25 3/4	27 3/4	+3/4
Inseams ²						+1/2
Short	28 1/2	28 1/2	28 1/2	28 1/2	28 1/2	
Regular	30 1/2	30 1/2	30 1/2	30 1/2	30 1/2	
Long	32 1/2	32 1/2	32 1/2	32 1/2	32 1/2	
Outseams ³						3/4
Short	43 3/4	43 3/4	43 3/4	43 3/4	43 3/4	
Regular	46 3/4	46 3/4	46 3/4	46 3/4	46 3/4	
Long	49 3/4	49 3/4	49 3/4	49 3/4	49 3/4	

¹Half waist measurement taken from folded edge to folded edge through the center of pile fastener tapes for side tabs and with drop seat and front zippers closed.

²Inseam is measured from the center of crotch seam to the bottom edge of leg along the seam.

³Outseam is measured from the top edge of the outseam to the bottom with the drop seat zipper closed

Table 3-12. National Stock Numbers for Overall, Combat Vehicle Crewmembers

SIZE	NSN
X-Small-Short	8415-01-111-5020
X-Small-Regular	8415-01-111-5021
X-Small-Long	8415-01-111-5022
Small-Short	8415-01-111-5023
Small Regular	8415-01-111-5024
Small-Long	8415-01-111-5025
Medium-Short	8415-01-111-5026
Medium-Regular	8415-01-111-5027
Medium-Long	8415-01-111-5028
Large-Short	8415-01-111-5029
Large-Regular	8415-01-111-5030
Large-Long	8415-01-111-5031
X-Large-Short	8415-01-111-7166
X-Large-Regular	8415-01-111-5032
X-Large-Long	8415-01-111-5033

3-12. REPAIR AND MAINTENANCE - Continued

- (5) Jackets may require replacement of worn cuffs and waistbands. Stock numbers of the cuffs, waistbands and thread are listed in Table 3-13
- (6) GLOVES. Repair of the gloves is restricted to restitching of open seams using thread conforming to MIL-T-436336 (NSN 8310-00-492-8397). Stock numbers of the gloves are listed in Table 3-14

Table 3-13. Cuffs and Waistbands

NOMENCLATURE	TYPE	CLASS	NSN
Cuffs, Knit, Aramid Nylon, MIL-C-3735	IV	2	8315-01-028-3627
Waistband, Knit, Aramid Nylon, MIL-C-3735	IV	3	8315-01-028-4896
Thread, Aramid Nylon, Green 1565, 3 Ply, MIL-T-83193			8310-00-405-2252

Table 3-14. Glove Sizes

NOMENCLATURE	SIZE	NSN	
		STD A	STD B
Glove, GS/FRP-2	5	8415-01-040-2012	
Glove, GS/FRP-2	6	8415-01-040-1453	
Glove, GS/FRP-2	7	8415-01-029-0109	8415-00-139-5408
Glove, GS/FRP-2	8	8415-01-029-0111	8415-00-139-5409
Glove, FS/FRP-2	9	8415-01-029-0112	8415-00-139-5410
Glove, FS/FRP-2	10	8415-01-029-0113	8415-00-139-5411
Glove, GS/FRP-2	11	8415-01-029-0116	8415-00-139-5412
Glove, CVC	5	8415-01-074-9428	
Glove, CVC	6	8415-01-074-9429	
Glove, CVC	7	8415-01-074-9430	
Glove, CVC	8	8415-01-074-9431	
Glove, CVC	9	8415-01-074-9432	
Glove, CVC	10	8415-01-074-9433	
Glove, CVC	11	8415-01-074-9434	
Glove, CVC	11	8415-01-074-9434	

3-12. REPAIR AND MAINTENANCE - Continued

(7) Coveralls, Stock numbers of the coveralls are listed in Table 3-17

- (a) Repair of the "NOMEX" flying coveralls, shirts or trousers, shall be restricted to open seams, holes or tears, not in excess of 4 inches (10.16 cm), replacement of hook and pile/slide fasteners. Thermal protection is reduced as coverall fabric becomes thin or excessively worn. Garment shall be condemned when it no longer provides the thermal protection of the soldier. Final determination shall be made by qualified maintenance personnel.

NOTE

- **Attachment of organizational insignias is permissible. Method of attachment is a command option. If sewn, use thread MIL-T-83193.**
 - **Attachment of Velcro tape for garter restraint system is MAJCOM option. If attached, sew, using thread MIL-T-83193.**
 - **Thread used for all repairs shall conform to Specification MIL-T-83193, National Stock No. 8310-00-405-2252 (color sage green).**
- (b) **HOLE.** Small holes or tears, not in excess of 1/2 inch (1.27 cm), may be mended and/or darned on a sewing machine. Care shall be taken to prevent bunching or piling of stitchings. To repair holes larger than 1/2 inch (1.27 cm) but less than 4 inches (10.16 cm), use patches shall be "NOMEX" fabric, NSN 8305-00-406-7449, color sage green.) Cut a piece of matching material at least 1 inch (2.54 cm) larger than the damaged area. Turn the edges of the patch under 1/4 inch (0.635 cm), center the patch on the underside of the hole and sew the patch 1/16 to 1/8 inch, (0.063 to 0.125 cm) from the folded edge. (Use stitch type 301 and 10-12 stitches per inch.) Turn the material and cut out the damaged area to form a square or rectangle. Cut diagonals 1/4 inch (0.635 cm) long at each corner of the square or rectangle. Turn the raw edges (as far as the diagonal will permit) under. Finish the repair patch by sewing a seam 1/16 to 1/8 inch (0.063 to 0.125 cm) from the edge of the fold. Patches not to exceed four each per coverall, jacket, shirt, or trousers.
- (c) **HOOK AND PILE FASTENER.** Any damaged hook and pile fastener tape may be replaced. Tapes shall conform to Type I, Specification MIL-F-21840, and sized to Table 3-15. Tapes shall be replaced as originally installed. Replacement hook and pile name plates, cut to size are available under National Stock No. 8315-00-403-1285 (color-sage green).
- (d) **SLIDE FASTENER.** Defective or nonoperative slide fasteners shall be replaced. Installation shall be in the same manner as the original fastener. Refer to Table 3-16 for CWU- 27/P coverall (sage green).

3-12. REPAIR AND MAINTENANCE-Continued**NOTE**

All frayed edges on coveralls, shirts, trousers, and jackets shall be trimmed to prevent jamming of the pocket slide fasteners.

- (e) Defective top collar of coveralls or shirt may be repaired or replaced using "NOMEX" fabric Thread shall conform to MIL-T-83193. If basic "NOMEX" materials is not available from appropriate supply organizations, the use of coveralls or shirt without collar liner is permissible

NOTE

It is recommended that new NOMEX material be laundered prior to installation to top collar in order to soften the fabric and eliminate any possible skin irritation that might occur due to original fabric harshness.

- (f) SEAMS. Open seams (no restriction to length) shall be repaired by restitching using the same type stitch and stitches per Inch as the original seam.
- (g) BUTTONS. Replace missing or damaged buttons.

3-12. REPAIR AND MAINTENANCE-Continued

Table 3-15. Hook and fastener Tape

Coverall Size	WIDTH AND CUT LENGTHS OF FASTENER TAPES (INCHES)				
	Back Belt <u>1/</u> Hook	Waist <u>1/</u> Pile	Tab <u>2/</u> Hook	1 Cuff <u>2/</u> Pile	Nameplate Hook and Pile
32S	1 by 4	1 by 6	1-1/2 by 2	1-1/2 by 6	2 by 4
32R	1 by 4	1 by 6	1-1/2 by 2	1-1/2 by 6	2 by 4
34S	1 by 4	1 by 6	1-1/2 by 2	1-1/2 by 6	2 by 4
34S	1 by 4	1 by 6	1-1/2 by 2	1-1/2 by 6	2 by 4
36S	1 by 4	1 by 6	1-1/2 by 2	1-1/2 by 6	2 by 4
36R	1 by 4	1 by 6	1-1/2 by 2	1-1/2 by 6	2 by 4
36L	1 by 4	1 by 6	1-1/2 by 2	1-1/2 by 6	2 by 4
38S	1 by 4	1 by 6	1-1/2 by 2	1-1/2 by 6	2 by 4
38R	1 by 4	1 by 6	1-1/2 by 2	1-1/2 by 6	2 by 4
38L	1 by 4	1 by 6	1-1/2 by 2	1-1/2 by 6	2 by 4
40S	1 by 4	1 by 7	1-1/2 by 2	1-1/2 by 6	2 by 4
40R	1 by 4	1 by 7	1-1/2 by 2	1-1/2 by 6	2 by 4
40L	1 by 4	1 by 7	1-1/2 by 2	1-1/2 by 6	2 by 4
42S	1 by 4	1 by 7	1-1/2 by 2	1-1/2 by 6	2 by 4
42R	1 by 4	1 by 7	1-1/2 by 2	1-1/2 by 6	2 by 4
42L	1 by 4	1 by 7	1-1/2 by 2	1-1/2 by 6	2 by 4
44S	1 by 4	1 by 8	1-1/2 by 2	1-1/2 by 6	2 by 4
44R	1 by 4	1 by 8	1-1/2 by 2	1-1/2 by 6	2 by 4
44L	1 by 4	1 by 8	1-1/2 by 2	1-1/2 by 6	2 by 4
46S	1 by 4	1 by 8	1-1/2 by 2	1-1/2 by 6	2 by 4
46R	1 by 4	1 by 8	1-1/2 by 2	1-1/2 by 6	2 by 4
46L	1 by 4	1 by 8	1-1/2 by 2	1-1/2 by 6	2 by 4
48R	1 by 4	1 by 9	1-1/2 by 2	1-1/2 by 6	2 by 4
48L	1 by 4	1 by 9	1-1/2 by 2	1-1/2 by 6	2 by 4

3-12. REPAIR AND MAINTENANCE - Continued**Table 3-16. Slide Fasteners (V-F-106)***Part I. Coverall, CWU-27/P, Slide Fastener V-F-106.*

Coverall Size	Location	Type	Style	Size	Length Inches	National Stock No.
All sizes	Leg opening	1	3	M	10	5325-00-138-4651
All sizes	Breast pockets	1	7	M	6-1/2	5325-01-049-0724
All sizes	Breast pockets	1	7	M	7	5325-00-138-4648
All sizes	Thigh pockets	1	7	M	7	
All sizes	Lower leg pockets	1	7	M	8-1/2	5325-00-138-4649
All sizes	Side pass-through	1	7	M	10	5325-00-138-4650
36S	Front opening	1	15	MS	26	5325-00-478-0713
36R/40S	Front opening	1	15	MS	27	5325-00-478-0715
38S	Front opening	1	15	MS	26-1/2	5325-00-478-0714
38R	Front opening	1	15	MS	27-1/2	5325-01-049-0720
40R	Front opening	1	15	MS	28	5325-00-495-3368
40L/44R	Front opening	1	15	MS	29	5325-00-476-7623
42R	Front opening	1	15	MS	28-1/2	5325-00-476-7622
42L/46R	Front opening	1	15	MS	29-1/2	5325-00-476-7624
44U48R	Front opening	1	15	MS	30	5325-00-478-0716
46L	Front opening	1	15	MS	30-1/2	5325-00-476-7625

3-12. REPAIR AND MAINTENANCE - Continued**Table 3-16. Slide Fasteners V-F-106 (continued)***Part II. Flyer's Jacket, CWU-26/P, Slide Fastener V-F-106.*

Jacket Size	Location	Type	Style	Size	Length Inches	National Stock No.
Small	Front opening	IV	8	M	20-1/2	5325-01-093-5237
Medium	Front opening	IV	8	M	21	5325-01-097-8997
Large	Front opening	IV	8	M	21-1/2	5325-01-097-8998
X-Large	Front opening	IV	8	M	22	5325-01-093-5238

Part III. Flyer's Jacket, CWU-45/P, Slide Fastener V-F- 106.

Jacket Size	Location	Type	Style	Size	Length Inches	National Stock No.
Small	Front opening	IV	8	MH	21	5325-01-093-5239
Medium	Front opening	IV	8	MH	21-1/2	5325-01-036-2830
Large	Front opening	IV	8	MH	22	5325-01-036-0130
X Large	Front opening	IV	8	MH	22-1/2	5325-01-036-0129

3-12. REPAIR AND MAINTENANCE - Continued

Table 3-17. Coverall National Stock Numbers

NATIONAL STOCK NUMBER		SUIT SIZES
Std A	Std B	
8415-01-043-8376	x	32 Short
8415-01-043-8377	x	32 Regular
8415-01-043-8378	x	34 Short
8415-01-043-8379	x	34 Regular
8415-01-043-8380	8415-00-491-0898	36 Short
8415-01-043-8381	8415-00-491-0901	36 Regular
8415-01-043-8382	8415-00-491-0902	36 Long
8415-01-043-8383	8415-00-491-0914	38 Short
8415-01-043-8384	8415-00-491-0915	38 Regular
8415-01-043-8385	8415-00-491-0925	38 Long
8415-01-043-8386	8415-00-491-0955	40 Short
8415-01-043-8387	8415-00-491-0956	40 Regular
8415-01-043-8388	8415-00-491-0959	40 Long
8415-01-043-8389	8415-00-491-0972	42 Short
8415-01-043-9529	8415-00-491-0983	42 Regular
8415-01-043-8390	8415-00-491-0986	42 Long
8415-01-043-8391	8415-00-491-0993	44 Short
8415-01-043-8392	8415-00-491-1001	44 Regular
8415-01-043-8393	8415-00-491-1002	44 Long
8415-01-043-8394	8415-00-491-1003	46 Short
8415-01-043-8395	8415-00-491-1009	46 Regular
8415-01-043-8396	8415-00-491-1017	46 Long
8415-01-043-8397	8415-00-491-1033	48 Regular
8415-01-043-8398	8415-00-491-1037	48 Long

3-13. WORKMANSHIP

All work shall be accomplished by personnel skilled in the trade applicable to their duties in the repair of the subject item. Darning shall be neatly accomplished and patches shall be of proper size and firmly stitched to the garments. Stitching and reseaming shall be secure and loose ends shall be turned and removed. Buttons, buckles, and belt loops shall be securely and properly attached to function as they were Intended. The finished items shall be complete and well repaired, thoroughly cleaned and rinsed, and free from all defects which may affect serviceability or general appearance.

3-14. INSPECTION

The inspection or quality control unit is responsible for determining compliance with repair Instructions and requirement for classification. In process inspections will be performed for quality of workmanship and correct application of repair procedure. The completed item will be inspected for serviceable appearance and condition, to insure against return of a substandard product to supply channels.

3-15. CLEANING**NOTE**

Determination as to who will launder/clean the garments is the responsibility of the MAJCOM.

- a. The Type CWU-27/P coverall, shirt, and trousers fabric is a drip-dry type requiring special handling and may be washed as frequently as needed. The coverall may be laundered at home or in a commercial-type washer and dryer. Commercial stain removers, such as Grease Release, may be used to remove embedded oil and grease from Type CWU-27/P (NOMEX) fabric. To remove the stains, a stain remover should be applied directly on the stain and a laundry brush used to scrub the area with warm water (about 120 degrees Fahrenheit (49°C)).
- b. Laundering in water up to 180 degrees Fahrenheit (82.2°C) maximum, and tumble drying up to 180 degrees Fahrenheit (82.2°C), will not damage or shrink the coverall. Use of a commercial fabric softener (STAY-PUFF, DOWNY, etc.), during rinse, will remove body oil during laundry process. The fabric softeners also serve to inhibit static generation. Ironing or pressing is permissible; however, it is difficult to remove wrinkles or creases, due to the high temperature resistant quality of Nomex fabric. Dry cleaning or laundering will not compromise the flame retardant properties of the "NOMEX" and no renewable flame retardant treatment is required.

NOTE

- **It is recommended that a new coverall, shirt, or trousers be laundered prior to use in order to soften the fabric and eliminate any possible skin irritation that might occur due to original fabric harshness. It is recommended that immediately after tumble drying or during drip drying, the coverall be hung on a hanger.**
- **DO NOT STARCH these uniforms. In event that the uniform is inadvertently starched, restore the fire resistance to its original state by rinsing the garment in warm water.**
- **Do not use any type of bleaching compound in laundering. To avoid excess wear on the gloves during washing and drying, make sure there are sufficient articles in the wash to absorb tumbling shock.**
- **After ten laundering cycles and thereafter launder in accordance with Formula IX (no bleach) of FM 10-280 and Natick Formula X, fixed laundry for the retreatment of anti-static agent.**

3-15. CLEANING- Continued

- c. FLIGHT GLOVES AND CVC GLOVES. Wash only when necessary and according to the following instructions:
 - (1) Wash gloves with mild soap in warm water (not exceeding 120° F). Do not bleach or starch.
 - (2) Rinse thoroughly in clear warm water. Remove all soap by repeated rinsing or fabric will lose its flame resistance.
 - (3) Remove excess water by squeezing gloves or rolling them in towel Do not wring or twist. Stretch gloves into shape and hang or lay flat to air dry. Do not tumble dry, or expose wet gloves to heat or direct sunlight.

- d. The jackets and hood should be commercially dry cleaned only.

Section III. MATERIALS - Continued

(1) SMR CODE	(2) NATIONAL STOCK NUMBER	(3) DESCRIPTION	(4) UNIT OF ISSUE
SHIRT AND TROUSERS			
PAFZZ	8310-00-262-0094	Thread, Gimp, Cotton: OD-S1, C.A. 66022, Size 8, type I or II, V-T-280	YD
PAOZZ	8310-00-492-8397	Thread, Nylon, Nonmelting: OD S-1, C.A. 66022, Type 1, size E, MIL-T-4336	RL
XBFZZ	8305-00-406-3496	Webbing, Textile, type I, MIL-W-43685 (Use Salvage Straps) Cut to Required Length	
PAFZZ	8315-00-260-0356	Tape, Textile, Natural, 1/4 or 3/8 Inch wide, DDD-T-86, Type I, Class 1 or 2	YD
PAO	8315-00-899-0029	Button; Sewing Hole, DOD shade BP, cable No. 62016, dull finish, size 30 line, V-B-871, Type II, Class D, Style 26	GR

Section III. MATERIALS - Continued

(1) SMR CODE	(2) NATIONAL STOCK NUMBER	(3) DESCRIPTION	(4) UNIT OF ISSUE
XBFZZ	5340-00-157-7987	Buckles, Adjustment Strap: Type II, style 3, class 3, MIL-B-543 (use salvage items)	EA
PAFZZ	5325-00-241-7136	Fastener, Slide, Shin Pockets; 8 1/2 inch, type I, size M, style 7, V-F-106.	EA
PAFZZ	5325-00-159-3764	Fastener, Slide, Thigh Pockets; 10 inch, type I, size M, style 23, V-F-106.	EA
PAFZZ	8315-00-151-6480	Fastener Tape: Hook, 1 in., MIL-F-21840, type I, Class 2	YD
PAFZZ	8315-00-151-6481	Fastener Tape: Hook, 1 1/2 in., MIL-F-21840, type I, Class 2	YD
PAFZZ	8315-00-151-6484	Fastener Tape: Pile, 1 in., MIL-F-21840, type I, Class 2	YD
PAFZZ	8315-00-151-6483	Fastener Tape: Pile, 1 1/2 in., MIL-F-21840, type I, Class 2	YD
PAFZZ	5325-00-159-3748	Fastener Slide' Interlocking, 6 3/4 in., V-F-106, type I, style 15, Size M	EA
PAFZZ	5325-00-159-3753	Fastener Slide: Interlocking, 7 1/4 in., V-F-106, type I, style 15, Size M	EA
PAFZZ	5325-00-159-3755	Fastener Slide: Interlocking, 7 3/4 in., V-F-106, type I, style 15, Size M	EA
PAFZZ	5325-00-159-3757	Fastener Slide: Interlocking, 8 1/4 in., V-F-106, type I, style 15, Size M	EA
PFFZZ		Fastener Slide: Interlocking, 8 3/4 in., V-F-106, type I, style 15, Size M	EA
PAFZZ	5325-00-159-3762	Fastener Slide: Interlocking, 9 1/4 in., V-F-106, type I, style 15, Size M	EA
PAFZZ	5325-00-159-3763	Fastener Slide: Interlocking, 9 3/4 in., V-F-106, type I, style 15, Size M	EA
PAFZZ	5325-00-159-3722	Fastener Slide: Interlocking, 5 in., V-F-106, type I, style 7, Size M	EA
PAFZZ	5325-00-159-3723	Fastener Slide: Interlocking, 20 in., V-F-106, type 4, style 8, Size M	EA
PAFZZ		Fastener Slide: Interlocking, Breast Pocket, 5 1/2 inch, V-F-106, type I, style 7, Size M	EA
PAFZZ		Fastener Slide: Interlocking, Breast Pocket, 6 inch, V-F-106, type I, style 7, Size M	EA
		LIGHTWEIGHT AND COLD WEATHER JACKETS	
XBFZZ	8305-00-483-1344	Cloth, High Temperature Resistant, Non-Melting Nylon: OG-106, MIL-C-43842	YD
PAFZZ	5325-00-285-1057	Fastener, Slide, Interlocking, 19 inches, Type IV, Style 8, Size M, Short Pull Tab, V-106	EA
PAFZZ		Fastener, Slide, Interlocking, 19 1/2 inches, Type IV, Style 8, Size M, Short Pull Tab, V-F-106	EA

Section III. MATERIALS - Continued

(1) SMR CODE	(2) NATIONAL STOCK NUMBER	(3) DESCRIPTION	(4) UNIT OF ISSUE
PAFZZ	5325-00-159-3723	Fastener, Slide, Interlocking, 20 Inches, Type IV, Style 8, Size M, Short Pull Tab, V-F-106	EA
PAFZZ	5325-01-093-5237	Fastener, Slide, Interlocking, 20 1/2 Inches, Type IV, Style 8, Size M, Short Pull Tab, V-F-106	EA
PAFZZ	5325-01-097-8997	Fastener, Slide, Interlocking, 21 Inches, Type IV, Style 8, Size M, Short Pull Tab, V-F-106	EA
PAFZZ	5325-01-097-8998	Fastener, Slide, Interlocking, 21 1/2 Inches, Type IV, Style 8, Size M, Short Pull Tab, V-F-106	EA
PAFZZ	5325-01-093-5238	Fastener, Slide, Interlocking, 22 Inches, Type IV, Style 8, Size M, Short Pull Tab, V-F-106	EA
PAFZZ	5325-00-275-4433	Fastener, Slide, Interlocking, 22 1/2 Inches, Type IV, Style 8, Size M, Short Pull Tab, V-F-106	EA
PAFZZ		Fastener, Slide, Interlocking, 23 Inches, Type IV, Style 8, Size M, Short Pull Tab, V-F-106	EA
PAFZZ	5325-00-159-3722	Fastener, Slide, Interlocking, 4 3/4 Inch, Type I, Style 7, Size M, Short Pull Tab, V-F-106	EA
PAFZZ	8315-00-151-6480	Fastener Tape, Hook, 1 Inch, MIL-F-21840, Type I, Class 2	YD
PAFZZ	8415-00-151-6484	Fastener Tape, Pile, 1 Inch, MIL-F-21840, Type I, Class 2	YD
PAFZZ	8415-01-010-7203	Fastener Tape, Hook, 5/8 Inch, MIL-F-21840, Type I, Class 2	YD
PAFZZ	8415-01-010-7204	Fastener Tape, Pile, 5/8 Inch, MIL-F-21840, Type I, Class 2	YD
PAFZZ	8310-00-492-8397	Thread, Nylon, Non-Melting, Olive Drab S-1, C.A. 66022, Type I, Sizes B and E, MIL-T-43636	TU
PAOZZ	8310-00-988-1298	Thread, Polyester, Cotton Covered, Olive Drab S-1, C.A. 66022, Ticket No. 50, 3 Ply, V-T-285, Type I, Class 1, Subclass A or B	TU
PAFZZ	8315-00-405-2298	Tape, Textile, Nylon, Non-Melting, MIL-T-43709	YD
PAFZZ	4020-00-243-3152	Twine, Fibrous, T-T-881, Type I	YD
PAFZZ		Cloth, Non-Melting Nylon, OG-106, MIL-C-43774	YD
PAFZZ	8315-01-024-5725	Cuffs, Knit, MIL-C-3735, Type IV, Class 2, Size 2	PR

Section III. MATERIALS - Continued

(1) SMR CODE	(2) NATIONAL STOCK NUMBER	(3) DESCRIPTION	(4) UNIT OF ISSUE
		COVERALL, COMBAT VEHICLE CREWMEMBER'S	
PAFZZ	8305-00-483-1344	Cloth, high temperature resistant non-melting Nylon, OG 106, MIL-C-43842 (Use for Patching)	YD
PAFZZ	8315-00-151-6479	Fastener tape, Hook, 2 inch, MIL-F-21840, Type I, Class 2	YD
PAFZZ	8315-00-151-6480	Fastener tape, Hook, 1 Inch, MIL-F-21840, Type I, Class 2	YD
PAFZZ	8315-00-151-6482	Fastener tape, Pile, 2 Inch, MIL-F-21840, Type I, Class 2	YD
PAFZZ	8315-00-151-6484	Fastener tape, Pile, 1 inch, MIL-F-21840, Type I, Class 2	YD
PAFZZ	8310-00-492-8397	Thread, nylon, non-melting, Olive Drab S-1 CA 66022, type I, sizes B and E, MIL-T-43636.	TU
PAFZZ	8305-00-406-3496	Webbing, Aramid Fiber, Natural color, MIL-W-43685, Type II	YD
PAFZZ	4020-00-243-3152	Twine, Fibrous, T-T-881, Type I	YD
PAFZZ		Fastener, slide, interlocking, 6 1/2 inches, type I, style 3, size M, Chain Brass, Black Finish, Tape, No Mex OG-106, V-F-106.	EA
PAFZZ	5325-00-138-4651	Fastener, slide, Interlocking, 9 1/2 inches, type I, style 3, size M, Chain Brass, Black Finish, Tape, No Mex OG-106, V-F-106.	EA
PAFZZ	5325-00-164-0827	Fastener, slide, interlocking, 12 1/2 inches, type I, style 3, size M, Chain Brass, Black Finish, Tape, No Mex OG-106, V-F-106.	EA
PAFZZ	5325-00-138-4650	Fastener, slide, interlocking, 10 inches, V-F-106, type I, style 7, size M	EA
PAFZZ	5325-00-478-0713	Fastener, slide, interlocking, 26 inches, V-F-106, type I, style 15, size MS	EA

Section III. MATERIALS - Continued

(1) SMR CODE	(2) NATIONAL STOCK NUMBER	(3) DESCRIPTION	(4) UNIT OF ISSUE
PAFZZ	5325-00-478-0714	Fastener, slide, interlocking, 26 1/2 inches, V-F-106, type I, style 15, size MS	EA
PAFZZ	5325-00-478-0716	Fastener, slide, interlocking, 30 inches, V-F-106, type I, style 15, size MS	EA
PAFZZ	5325-00-476-7625	Fastener, slide, interlocking, 30 1/2 inches, V-F-106, type I, style 15, size MS	EA
PAFZZ	5325-00-159-3722	Fastener, slide, interlocking, 4 3/4 inches, type I style 7, size M, Chain Brass, Black Finish, Tape, No Mex OG-106, V-F-106.	EA
PAFZZ	5325-00-138-4648	Fastener, slide, interlocking, 7 1/2 inches, type I, style 7, size M, Chain Brass, Black Finish tape, No Mex OG-106, V-F-106.	EA
PAFZZ	5325-00-138-4649	Fastener, slide, interlocking, 8 1/2 inches, type I, style 7, size M, Chair Brass, Black Finish, Tape, No Mex OG-106, V-F-106.	EA
PAFZZ		Fastener, slide, interlocking, 22 inches, type I, style 15, size M, Chain Brass, Black Finish, Tape, No Mex OG-106, V-F-106.	EA
PAFZZ		Fastener, slide, interlocking, 23 inches, type I, style 15, size M, Chain Brass, Black Finish, Tape, No Mex OG-106, V-F-106.	EA
PAFZZ	5325-00-478-0715	Fastener, slide, interlocking, 24 inches, type I, style 15, size M, Chain Brass, Black Finish, Tape, No Mex OG-106, V-F-106.	EA
PAFZZ	5325-00-478-0715	Fastener, slide, interlocking, 27 inches, type I, style 15, size M, Chain Brass, Black Finish, Tape, No Mex OG-106, V-F-106.	EA
PAFZZ	5325-01-049-0720	Fastener, slide, interlocking, 27 1/2 inches, type I, style 15, size M, Chain Brass, Black Finish, Tape, No Mex OG-106, V-F-106.	EA
PAFZZ	5325-00-495-3368	Fastener, slide, interlocking, 28 inches, type I, style 15, size M, Chain Brass, Black Finish, Tape, No Mex OG-106, V-F-106.	EA

Section III. MATERIALS - Continued

(1) SMR CODE	(2) NATIONAL STOCK NUMBER	(3) DESCRIPTION	(4) UNIT OF ISSUE
PAFZZ	5325-00-476-7622	Fastener, slide, interlocking, 28 1/2 inches, type I, style 15, size M, Chain Brass, Black Finish, Tape, No Mex OG-106, V-F-106.	EA
PAFZZ	5325-00-476-7623	Fastener, slide, interlocking, 29 inches, type I, style 15, size M, Chain Brass, Black Finish, Tape, No Mex OG-106, V-F-106.	EA
PAFZZ	5325-00-476-7624	Fastener, slide, interlocking, 29 1/2 inches, type I, style 15, size M, Chain Brass, Black Finish, Tape, No Mex OG-106, V-F-106.	EA
LINER, COMBAT VEHICLE CREWMEMBER'S COVERALL			
PAFZZ	8310-00-492-8397	Thread, Nylon, non-melting, Olive Drab S-1, C.A. 66022, type I, sizes B and E, MIL-T-43636.	TU
XBFZZ		Cloth, Plain or Pajama check weave, Aramid, 3 ounces per square yard, Olive Green 106, MIL-C-43774.	YD
PAFZZ	8305-00-406-3496	Webbing, Aramid fiber, Olive Green 106, 5/8 inch wide, MIL-W-43685, type I.	YD
PAOZZ		Fasteners, snap; style 2A, finish 2, male & female complete stud & eyelet, size 1 or 2 and socket size 1 or 2, MIL-F-10884.	EA
OVERALL, COMBAT VEHICLE CEWMEMBER'S			
PAFZZ	8305-00-483-1344	Cloth, high temperature resistant, non-melting nylon; OG-106, MIL-C-43842.	YD

Section III. MATERIALS - Continued

(1) SMR CODE	(2) NATIONAL STOCK NUMBER	(3) DESCRIPTION	(4) UNIT OF ISSUE
XBFZZ		Webbing, elastic, cotton, 1 15/32 wide, Blackstone Webbing Co. Style + 2662 or equal. Local purchase.	YD
PAFZZ	8315-00-151-6479	Fastener tape, hook, 2 inch, MIL-F-21840, type I, class 2.	YD
PAFZZ	8315-00-151-6482	Fastener tape, pile, 2 inch, MIL-F-21840, type I, class 2.	YD
PAFZZ	8310-00-492-8397	Thread, nylon, non-melting, Olive Drab S-1, CA 66022, type I, sizes B and E, MIL-T-43636.	TU
PAFZZ	4020-00-243-3152	Twine, Fibrous, T-T-881 Type I.	YD
PAFZZ		Fastener, slide, interlocking, 22 inches, type 1, style 15, size M, Chain Brass, Black Finish, tape, No Mex OG-106, V-F-106.	EA
PAFZZ		Fastener, slide, interlocking, 23 inches, type I, style 15, size M, Chain Brass, Black Finish, tape, No Mex OG-106, V-F-106.	EA
PAFZZ		Fastener, slide, Interlocking, 24 inches, type I, style 15, size M, Chain Brass, Black Finish, tape, No Mex OG-106, V-F-106.	EA
PAFZZ	5325-00-138-4648	Fastener, slide, Interlocking, 7 1/2 inches, type I, style 7, size M, Chain Brass, Black Finish, Tape, No Mex OG-106, V-F-106.	EA
PAFZZ	5325-00-138-4649	Fastener, slide, interlocking, 8 1/2 inches, type I, style 7, size M, Chain Brass, Black Finish, Tape, No Mex OG-106, V-F-106.	EA
PAFZZ		Fastener, slide, interlocking, 12 inches, type I, style 3, size M, Chain Brass, Black Finish, Tape, No Mex OG-106, V-F-106.	EA
PAFZZ		Fastener, slide, interlocking, 16 inches, type I, style 3, size M, Chain Brass, Black Finish, Tape, No Mex OG-106, V-F-106.	EA

Section III. MATERIALS - Continued

(1) SMR CODE	(2) NATIONAL STOCK NUMBER	(3) DESCRIPTION	(4) UNIT OF ISSUE
PAFZZ		Fastener, slide, interlocking, 17 inches, type I, style 3, size M, Chain Brass, Black Finish, Tape, No Mex OG-106, V-F-106.	EA
PAFZZ		Fastener, slide, interlocking, 18 inches, type I, style 3, size M, Chain Brass, Black Finish, Tape, No Mex OG-106, V-F-106.	EA
XBOZZ		Slide, belt (suspender) 1 1/2 inches wide, black, conforming to Waterbury Buckle Style No. 95, North Judd No. 02300 or equal. Cannibalize where possible.	EA
XBOZZ		Suspender loop, 1 1/2 inches black; conforming to Scovill "Howe loop style" or equal. Cannibalize where possible.	EA
PAOZZ		Button Tack and rivet, black, the button tack shall conform to Scovill No. 74-3334-27-13-0161 or equal and the rivet shall conform to Scovill No. 74-0533-14-01-1163 or equal.	EA
PAOZZ	8305-00-281-8016	Cord, elastic, Olive Green, 3/16 inch diameter, MIL-C-43303.	YD

CHAPTER 4
MAINTENANCE OF MEN'S COTTON/POLYESTER AND WOOL SERVICE TROUSERS

Section I. INTRODUCTION

4-1. SCOPE

This chapter provides instructions that cover the materials, methods, procedures for the repair and maintenance of the men's tan 445 polyester/cotton, AG 44 wool, and AG 344 polyester/wool trousers.

4-2. COMMODITY SPECIFICATIONS

a. Items.

ITEM	SPECIFICATION
Trousers, Men's Army Tan 445, Durable Press Trousers, Men's, Wool Serge, AG 44 and Trousers, Men's Polyester/Wool AG 344	MIL-T-43853B (GL) MIL-T-41828F

b. Components.

ITEM	SPECIFICATION
Button, Sewing Hole; & Button, Staple (Plastic)	V-B-871
Fasteners, Slide, Interlocking	V-F-106
Thread, Cotton	V-T-276
Thread, Cotton Gimp, Buttonhole	V-T-280
Thread, Polyester	V-T-285
Thread, Nylon	V-T-295
Cloth, Buckram, Cotton	CCC-C-438
Cloth, Twill, Polyester/Cotton (Durable Press)	MIL-C-43791
Cloth, Silesia, Cotton	MIL-C-326
Braid, Textile, Nylon, Mohair and Cotton	MIL-B-593
Cloth, Serge, Wool	MIL-C-823
Cloth, Tropical: Polyester/Wool	MIL-C-21115

4-3. TECHNICAL PUBLICATIONS

NUMBER	TITLE
FM 10-280	Field Laundry, Bath and Clothing Exchange Operations

4-4. IDENTIFICATION AND DESCRIPTION

- a. Trouser's, Men's, Army Tan 445, Durable Press. The trousers are fabricated from polyester/cotton, twill, cloth, conforming to Type I, of MIL-C-43791. The trousers have two side pockets and two hip pockets with a button and buttonhole tab on the left hip pocket and a zipper front closure with a hook and eye fastener at the top of the waistband (fig. 4-1).
- b. Trousers, Men's Wool Serge, Army Green Shade 44. These trousers will conform to Class 1 of MIL-T-43957. The garment is fabricated essentially of wool serge cloth. It is constructed with sewn-on waistband and belt loops, two side pockets, two hip pockets with a button and buttonhole tab on the left hip pocket and zipper fly closure with a hook and eye fastener at the top of the waistband (fig. 4-2).
- c. Trousers, Men's, Polyester/Wool, Tropical, Army Green 344. This item is constructed essentially of polyester/wool, tropical conforming to Class 3 of MIL-C-21115. The trouser is constructed with sewn-on waistband and belt loops, two side pockets, two hip pockets with a button and buttonhole tab on the left hip pocket, and a zipper closure with a hook and eye fastener at the top of the waistband (fig. 4-2).
- d. Trousers, Men, Polyester/Wool Serge, Army Green 344. The trouser is fabricated essentially of polyester/wool serge conforming to Class 6 of MIL-C-823. It is constructed with sewn-on waistband and belt loops, two side pockets, two hip pockets with a button and buttonhole tab on the left hip pocket and a zipper fly closure with a hook and eye fastener at the top of the waistband (fig. 4-2).

4-4. IDENTIFICATION AND DESCRIPTION-Continued

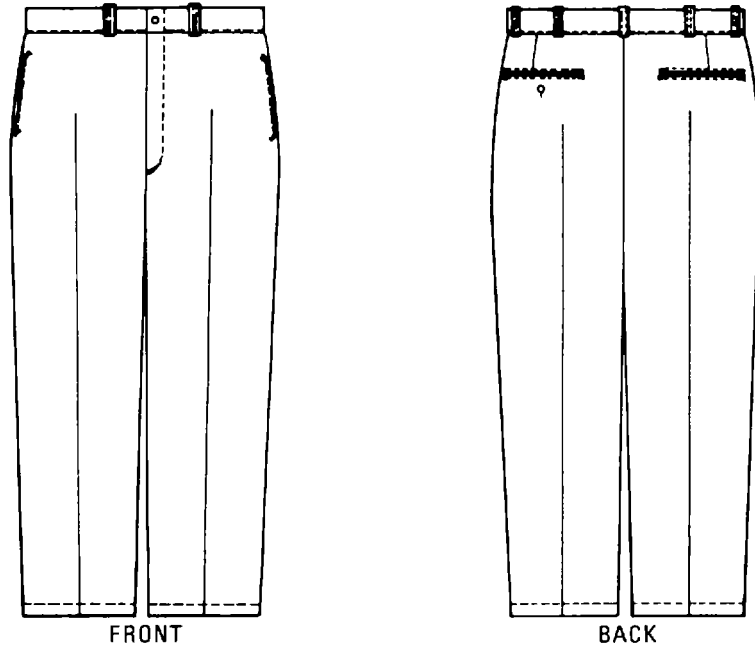

Figure 4-1. Trousers, men's, polyester/cotton, class I.

4-4. IDENTIFICATION AND DESCRIPTION-Continued

Figure 4-2. Trousers, men's, wool and polyester/wool

Section II. REPAIR PROCEDURES**4-5. MATERIALS**

Materials used in the repair of the trousers shall be serviceable materials recovered from similar salvaged items, when authorized, or will be new materials as specified in section III. New materials will be requisitioned from stock under the stock numbers and/or item description and shall conform to the appropriate specifications. When not available from stock, the materials may be purchased locally which conform as closely as possible to the standard material.

4-6. REPAIR AND MAINTENANCE OF UNIFORMS

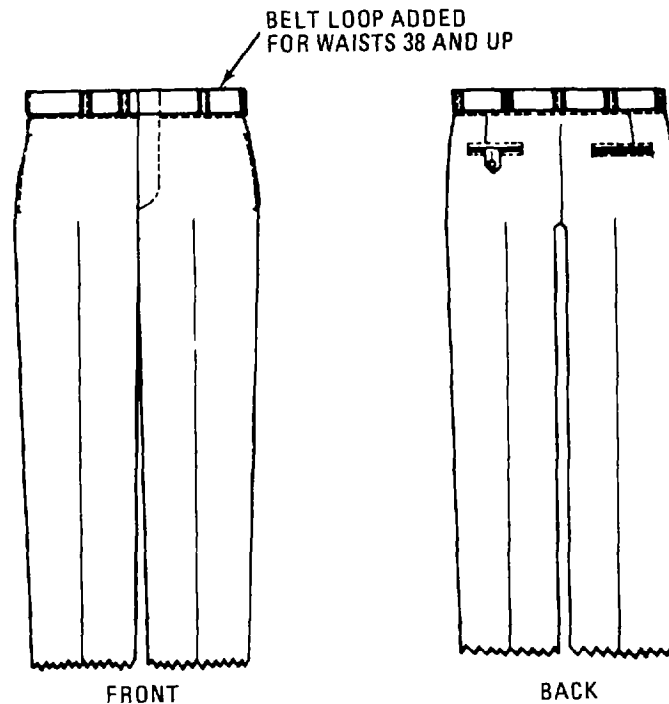
Prior to repair operations, each item shall be inspected by qualified personnel to determine the amount of repair necessary. The following methods shall be observed as fully as skills, facilities, funds and local conditions permit. The sequence of operations shall be determined by the repairing organizations, unless otherwise prescribed.

- a. Inspection. Inspect all Items to determine the amount of repairs needed and whether such repairs can be accomplished within the organization.
- b. Repair. The following repairs will be accomplished by hand or organizational maintenance such as missing and damaged buttons, sewing rips, tears and loose seams, and attaching loose belt loops. In replacing buttons, use appropriate type from those specified in section III, matching the original so that all buttons are the same color, design and size, and insure proper alignment with buttonhole.
- c. Cleaning. Remove dirt, dust, and other foreign matter by brushing. Cotton trousers can be hand washed using water as hot as the hands can stand and a mild soap or detergent. Stains in cotton and wool trousers should be removed in accordance with the following chart.

PROCEDURES FOR STAIN REMOVAL

TYPE OF STAIN	PROCEDURE FOR COTTON FABRIC	PROCEDURE FOR WOOL FABRIC	PROCEDURE FOR SYNTHETIC FABRIC
GRAVY	Rub the stain with cold water; then place a pad or cloth underneath the fabric to absorb the stain, and rub the stain with cleaning fluid. If any stain remains, dry the fabric and rub it with a soap or synthetic detergent solution. Do not rub excessively since this may damage the finish of the garment.	Same as the procedure for cotton fabric.	Sponge the area with cold or lukewarm water. If the grease spot remains, launder the washable materials in a soap or synthetic detergent solution, using warm water. Do not rub the material.
FOOD	Dampen the stained area with water. Apply soap or a synthetic detergent solution (with ammonia if available), tamp the area with a brush, and flush it with water.	Same as the procedure for cotton fabric.	Same as the procedure for gravy (above)

4-6. REPAIR AND MAINTENANCE OF UNIFORMS-Continued

PROCEDURES FOR STAIN REMOVAL - Continued

TYPE OF STAIN	PROCEDURE FOR COTTON FABRIC	PROCEDURE FOR WOOL FABRIC	PROCEDURE FOR SYNTHETIC FABRIC
MILK	Same as the procedure for a food stain.	Same as the procedure for cotton fabric.	Same as the procedure for gravy.
FRUIT OR FRUIT JUICES	Use boiling or hot water and wash the stain while it is still moist.	Flush the stained area with lukewarm water. Apply soap or synthetic detergent solution, tamp the area with a brush, and flush it out with water. (If available, apply lemon juice or vinegar and flush thoroughly with water.)	Same as the procedure for gravy.
GREASE OR OIL	Scrape off the top of the stain, then saturate the stained area with cleaning fluid, tamp the area with a brush and flush it out with cleaning fluid.	Same as the procedure for cotton fabric.	Scrape off the top of the stain. Launder washable materials in a soap or synthetic detergent solution, using warm water. Do not rub the material.
BLOOD	Flush and rub the stained area with water; then wash the stain with soap or synthetic detergent solution.	Dampen the stained area with water. Apply soap or synthetic detergent solution (with ammonia if available), tamp the area with a brush, and flush it with water.	Flush the stained area with lukewarm or cold water, then, using warm water, wash the stain with a soap or synthetic detergent solution. If the stain remains, sponge it with hydrogen peroxide. (Do not use bleach on colored material.)

4-6. REPAIR AND MAINTENANCE OF UNIFORMS-Continued

PROCEDURES FOR STAIN REMOVAL - Continued

TYPE OF STAIN	PROCEDURE FOR COTTON FABRIC	PROCEDURE FOR WOOL FABRIC	PROCEDURE FOR SYNTHETIC FABRIC
BLOOD (DRIED)	Scrape off the top of the stain. Dampen the stained area with water, apply soap or synthetic detergent solution (with ammonia if available), tamp the area with a brush, and flush it with water.	Same as the procedure for cotton fabric.	Scrape off the top of the stain. Flush the stained area with lukewarm or cold water; then, using warm water, wash the stain with soap or synthetic detergent solution. If the stain remains, sponge it with hydrogen peroxide. (Do not use bleach on colored material.)

d. Direct Support Maintenance.

- (1) Preliminary examination and cleaning. Dirt, mud, dust, spots, stains, and other foreign matter shall be removed with a brush or by laundering. Mildewy and rotten items shall be discarded. Seams shall be tested by grasping the item with both hands and pulling at right angles to the seam. Areas to be repaired shall be marked with a crayon. Nonspecification and personal marks shall be erased or obscured.
- (2) Laundry/dry cleaning. Cotton trousers shall be processed in laundry facilities in accordance with laundry formula I of FM 10-280. Wool or wool blend trousers shall be dry-cleaned in accordance with label instructions or in accordance with accepted commercial standards.
- (3) Repairs.
 - (a) Stitching. Use machine stitching for stitching and restitching trousers. For illustrations of the types of stitches used, see Fed. Std. 751. The following types of stitches, thread size, and stitches per inch are required for the repair (table 4-1). When machine stitching, type 301 is not a continuous thread, backstitch not less than one inch at each break. Backstitch all stitching at the ends to prevent raveling. Maintain the proper thread tension to prevent loose stitching and to imbed the lock in the center of the materials sewn. Overlock all thread breaks in overedge stitching not less than 3/4 inch (1.91 cm) at each break. Restitch all seams having loose or weak thread.

4-6. REPAIR AND MAINTENANCE OF UNIFORMS-Continued

- (b) Patching and darning Repair small rips and tears not exceeding 1/2 inch (1.27 cm) across their greatest diameter by drawing the edges together and darning with a zigzag stitch. Repair holes, rips, and tears exceeding 1/2 Inch (1.27 cm) by patching them when acceptable to appearance standards. Cut the patch from appropriate material (sec III) to match the section being repaired and insert it under the damaged area. Cut the patch large enough to extend not less than 1/4 Inch (0.635 cm) and no more than 3/8 inch (0.953 cm) around the perimeter of the opening. Either darn or patch the areas in waist bands, fly linings, watch pocket, side pockets, and hip pockets, or other areas where the repair work will not show when the item is worn.
- (c) Buttons. Replace missing, broken, or damaged buttons to match the originals (sec. III). Machine stitching for buttons is preferred, however, hand sewing may be used. Sew buttons on waistbands to align with buttonholes for a smooth and complete closure.

Table 4-1. Stitching Instructions

LOCATION	STITCH TYPE	NEEDLE	THREAD BOBBIN	STITCHES PER INCH
General	301	IA-50/3	IA-50/3	10-16
Overedge	503 or 504	IA-70/2	IA-70/2	6-8
Buttonholes		IA-30/3	IA-50/3	46-52 (ea)
Bartack		IA-50/3	IA-50/3	21 (ea)
Bartack		IA-30/3	IA-30/3	28 (ea)
Bartack	301	IA or IB-20/4	IA or IB-20/4	15 (ea)

- (d) Pockets. Darn or patch damaged corners of pockets by machine or remove badly damaged pockets and replace with new ones. Fabricate pockets from materials specified in section III and to the design of the original.
- (e) Buttonholes. Reshape enlarged buttonholes by securely tacking the ends for proper fit over corresponding buttons. Rework damaged buttonholes by stitching a small reinforcement patch to the under side of the garment and reworking through the patch. Buttonholes shall be of the eyelet-end taper bar type worked over gimp (sec III).
- (f) Hems. Turn under frayed bottom hems and stitch in place. Perform this operation in such a manner as to prevent areas of sharp color contrast or other adverse effect to the general appearance.

4-6. REPAIR AND MAINTENANCE OF UNIFORMS-Continued

- (g) Belt loops. Replace missing, broken, badly worn, or torn belt loops with new loops fabricated of material to match the part being replaced.
- (h) Slide fasteners. Replace missing or damaged slide fasteners by machine stitching fasteners as applicable (table 4-4 and sec. III).

- (4) Resizing. Resize all items after complete repairs and cleaning have been accomplished, using the schedule of sizes listed below. When garments do not correspond to original markings, obliterate the old marking and legibly write or stamp the proper size with an indelible pencil or waterproof ink, near the old size. When the measurements do not correspond to a size listed, relabel to nearest inseam and waist size. For example, if the trouser measures 31 3/4 in the waist and 30 1/4 Inseam, mark in the waistband "32 x 30". Trousers in good wearable condition should not be sent to salvage because the waist or Inseam measurements are off 1/2 Inch.
 - (a) Trousers, men's, Army Tan 445, polyester/cotton (table 4-2).
 - (b) Trousers, men's AG 44 and AG 344, wool and polyester/wool.

4-7. WORKMANSHIP

All work shall be accomplished by personnel skilled in the particular trade applicable to their duties in the repair of subject items. Darning shall be neatly accomplished and patches shall be of the proper size and firmly stitched to the garments. Stitching and reseaming shall be secure, and loose ends shall be turned and removed. Buttons, buckles and belt loops shall be securely and properly attached to function as intended. The finished items shall be completely and well repaired, thoroughly cleaned, and free from all defects which may affect serviceability or general appearance

4-7. WORKMANSHIP-Continued

Table 4-2. Sizing Instructions for Trousers

(Finished measurements in inches)

MEASUREMENTS

SIZES	WAIST * (TOL $\pm 3/8$, - 1/4 IN.)	INSEAM ** (TOL $\pm 1/2$ INCH)
25	12 1/2	
26	13	
27	13 1/2	
28	14	
29	14 1/2	
30	15	
31	15 1/2	
32	16	
33	16 1/2	
34	17	
35	17 1/2	
36	18	
37	18 1/2	
38	19	
39	19 1/2	
40	20	
42	21	
44	22	
46	23	
48	24	

*One half waist measurement taken along top edge of waistband from folded edge to folded edge with front closed.

**Inseam measurement taken along inseam from crotch seam to bottom edge. Leg length measurements shall not be uneven by more than 1/2 inch.

4.7. WORKMANSHIP - Continued

Table 4-3. Sizing Instructions for Trousers

(Finished measurements in inches)

MEASUREMENT	SIZE												TOLERANCE	
	24	26	28	30	32	34	36	38	40	42	44	46	PLUS	MINUS
EVEN SIZES														
1/2 Waist *	12	13	14	15	16	17	18	19	20	21	22	23	1/4	1/4
Inseams ** (unhemmed)														
X-short		30	30	30	30	30	30	30	30	30	30		1	1/2
Short		32	32	32	32	32	32	32	32	32	32		1	1/2
Regular	34	34	34	34	34	34	34	34	34	34	34		1	1/2
Long	36	36	36	36	36	36	36	36	36	36	36		1	1/2
X-Long		38	38	38	38	38	38	38	38	38	38		1	1/2
ODD SIZES	23	25	27	29	31	33	35	37	39	41	43	45		
1/2 Waist *	11 1/2	12 1/2	13 1/2	14 1/2	15 1/2	16 1/2	17 1/2	18 1/2	19 1/2	20 1/2	21 1/2	22 1/2	1/4	1/4
Inseams ** (unhemmed)														
X-Short			30	30	30	30	30	30	30	30	30	30	1	1/2
Short			32	32	32	32	32	32	32	32	32	32	1	1/2
Regular	34	34	34	34	34	34	34	34	34	34	34	34	1	1/2
Long		36	36	36	36	36	36	36	36	36	36	36	1	1/2
X-Long			38	38	38	38	38	38	38	38	38	38	1	1/2

*One-half waist measurement taken from edge to folded edge along top edge of waistband with the slide fastener closed and the waistband hooked

** Leg length measurement taken along inseam from crotch seam to unfinished bottom edges (an allowance of 3 inches for hems to be included in the inseam length)

4-7. WORKMANSHIP-Continued

Table 4-4. Slide Fastener Guide

SIZE OF TROUSER		LENGTH OF SLIDE FASTENER
WAIST	INSEAM	INCHES (+ 1/4 INCH)
26-31	29	10
32-36	29	10 1/2
38-42	29	11
26-30	31	10
31-36	31	10 1/2
38-44	31	11
26-30	33	10 1/2
31-36	33	11
38-46	33	11 1/2
48	33	12
28-30	35	11
31-36	35	11 1/2
38-44	35	12
30-34	37	12
36-38	37	12 1/2
40-44	37	13

4-8. INSPECTION

The inspection or quality control unit is responsible for determining compliance with repair instructions and requirement for classification. In process inspections will be performed for quality of workmanship and correct application of repair procedure. The completed item will be inspected for serviceable appearance and condition, to insure against return of a substandard product to supply channels.

Section III. MATERIALS - Continued

(1) SMR CODE	(2) NATIONAL STOCK NUMBER	(3) DESCRIPTION	(4) UNIT OF ISSUE
		TROUSERS, ARMY TAN 445	
PAFZZ		Cloth, polyester/cotton, twill, Army Tan 445, type I, MIL-C-43791	YD
PAFZZ	8310-00-187-3895	Thread, Cotton, Khaki P-1, 66019. 3 ply. ticket No. 50. type IA3, A-A-52904.	SL
XBFZZ		Buttons, type II, Class D, Style 4, 22 line, V-B-871, Tan AJ, Cable No. 62028. Purchase locally	EA
XBFZZ		Hook and Eye, Waistband, Nickel Plate Finish. Purchase locally.	SE
XBFZZ		Fastener, Slide, Interlocking, type I, style 1, Size L, V-F-106, Army Tan 445. Purchase Locally.	EA
		TROUSERS, WOOL AND POLYESTER/WOOL	
PAFZZ	8305-01-103-6402	Cloth, Serge, Polyester and wool; 11.3 oz, Army Green 489, type III, class 3, MIL-C-823.	YD
PAFZZ		Cloth, Wool, Serge, 15 oz, shade Army Green No. 44, type I, class 5, MIL-C-823.	YD
PAFZZ	8305-00-177-4848	Cloth, Tropical, Polyester/Wool, 9 oz, MIL-C-21115, type III, class 3.	YD
PAFZZ		Cloth, Cotton Buckram Bleached, A-A-50186, type II. Purchase locally.	YD
PAFZZ	8310-00-634-9824	Thread, Cotton 3 ply, Army Green 489, A-A-52094, type III, ticket No. A.	SL
PAFZZ		Thread, Cotton Covered, Polyester, Army Green 489, A-A-50199, 501 2 Ply.	CE

Section III. MATERIALS - Continued

(1) SMR CODE	(2) NATIONAL STOCK NUMBER	(3) DESCRIPTION	(4) UNIT OF ISSUE
PAFZZ		Thread, Cotton Covered, Polyester, 70/2 ply, Army Green 489, A-A-50199.	CE
PAFZZ	8310-00-988-1298	Thread, Polyester, Olive Drab, type I, class 1, sub-class A, size A and AA of V-T285.	TU
PAFZZ		Thread, Nylon, Waxed Monocord, 16 lbs tensil strength, minimum length of 2150 yards per lb. Color fast, V-T-295. Purchase locally.	CE
PAFZZ	8315-00-641-0495	Button, Sewing Hole, Army Green Shade BR, 62015, Glossy Finish, type II, class D, style 4, 22-line, V-B-871.	GR
PAFZZ	8310-00-634-9821	Thread, Gimp, Cotton, No. 8, Green 66034, A-A-50198, type I or II.	SL
XBFZZ		Fastener, Slide, Interlocking, Type I, style 1, size LS, V-F-106, green shade X, Cable No. 66524. Purchase locally.	EA
XBFZZ		Hook and Eye, Waist Band; Nickel Plate Finish. Purchase locally.	SE

CHAPTER 5

MAINTENANCE OF MEN'S WOOL, WOOL-NYLON SHIRT AND TROUSERS

Section I. INTRODUCTION

5-1. SCOPE

This chapter provides instructions covering the materials, methods, procedures for the repair and the maintenance of men's wool shirt and trousers.

5-2. COMMODITY SPECIFICATIONS

a. Items.

ITEM	SPECIFICATION
Shirt, Man's, Field, Wool/Nylon, Olive Green 108	MIL-S-10858
Trousers, Men's, Field, Wool M-1951	MIL-T-1870

b. Components.

ITEM	SPECIFICATION
Button, Sewing Hole, and Button, Staple (plastic)	V-B-871
Fasteners, Slide, Interlocking	V-F-106
Laces, Footwear, Spun Nylon	V-L-61
Thread, Cotton	V-T-276
Thread, Cotton Gimp, Buttonhole	V-T-280
Cloth, Drill, Cotton	CCC-C-426
Webbing, and Tape, Textile, Cotton, General Purpose	MIL-W-530
Buckles, Tongueless, and Web Strap	MIL-B-543
Cloth, Serge, Wool and Nylon	MIL-C-1065
Cloth, Flannel, Wool and Nylon, 16 Ounce, Shrink Resistant	
Tape, Textile, Cotton, General Purpose	MIL-T-43566
Cloth, Oxford Nylon	MIL-C-508
Cloth, Twill, Polyester and Cotton	MIL-C-43718

5-3. TECHNICAL PUBLICATIONS

NUMBER	TITLE
FM 10-280	Field Laundry, Bath, and Clothing Exchange Operations

5-4. IDENTIFICATION AND DESCRIPTION

a. Shirt. The wool-nylon flannel shirt (NSN 8405-00-188-3791 thru 3794 and 3798) is made essentially of shrink resistant 16 ounce olive green shade 108 nylon and wool cloth conforming to MIL-C-11065. The shirt has two breast patch pockets with buttoned flaps and a pencil pocket in left breast pocket; front facing interlined with a strip of polyester/cotton twill cloth for reinforcing buttons and button-holes; six 4-hole, 30-line sewing buttons securing shirt front, two such buttons securing cuffs, one button on each pocket for securing the flap; and a nylon collar lining for comfort. The shirt tail has a square design to permit wearing either outside or inside the trousers. For further identification see figure 5-1.

b. The wool trousers (NSN 8405-00-231-7199 thru 7213) are made essentially of 18 ounce wool serge cloth, olive green shade 108. The trousers are made with a grow-on waistband, single needle construction; with seat and leg seams pressed open and flat; two side pockets; two hip pockets and a waistband lining pocket with button and buttonhole closure. The trousers have outlets at seat seam, belt loops, suspender straps, suspender buttons, and waist adjustments. For further identification see figure 5-2.

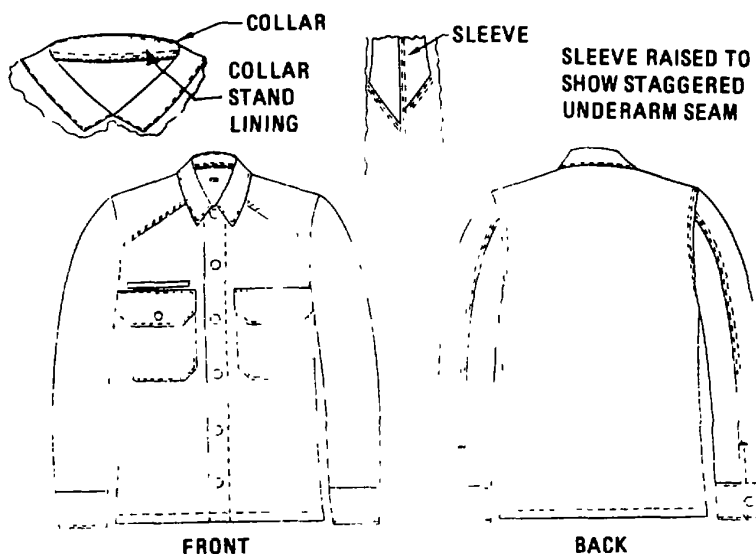

Figure 5-1. Shirt, cold weather field, wool/nylon, olive green shade No. 108.

5-4. IDENTIFICATION AND DESCRIPTION - Continued

Figure 5-2. Trousers, men's, field, wool M-1951.

Section II. REPAIR PROCEDURES**5-5. GENERAL**

Materials used in the repair of the shirt and trousers shall be serviceable materials recovered from similar salvaged items, when authorized, or will be new materials as specified in section III. New materials will be requisitioned from stock under the stock numbers and/or item descriptions and shall conform to the appropriate specification. When not available from stock, the materials may be purchased locally when they conform as closely as possible to the standard material.

5-6. REPAIR AND MAINTENANCE OF UNIFORMS

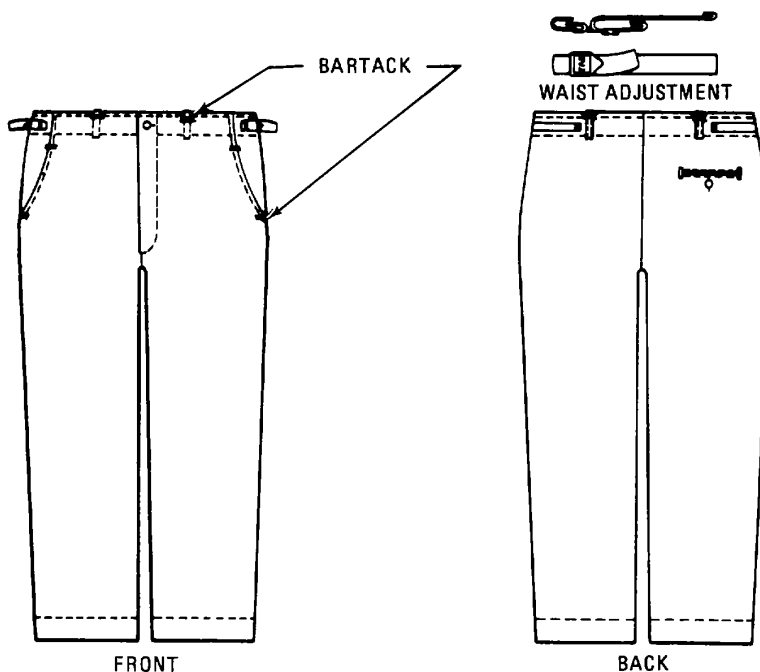
Prior to repair operations, each item shall be inspected by qualified personnel to determine the amount of repair necessary. The following methods shall be observed as fully as skills, facilities, funds, and local conditions permit. The sequence of operations shall be determined by the repairing organizations, unless otherwise prescribed.

5-6. REPAIR AND MAINTENANCE OF UNIFORMS - Continued

- a. Inspection. Inspect all subject items to determine the amount of repairs needed and whether such repairs can be accomplished within the organization.
 - b. Repair. The following indicated repairs will be accomplished by hand sewing only at organizational maintenance:
 - (1) Replace missing or damaged buttons.
 - (2) Re-sew or patch rips, tears, and loose seams.
 - (3) Re-sew torn-out buttonholes and attach loose belt loops.
 - c. Cleaning. Items shall be kept clean by the users, either by dry cleaning, if possible, or wash at low temperature for a short time, squeeze thoroughly dry.
 - d. Direct Support Maintenance.
 - (1) Preliminary examination and cleaning. Dirt, mud, dust, spots, mildew stain, and other foreign matter shall be removed with a hard bristle brush or by other means when available. Mildewed and rotten items shall be discarded. Seams shall be tested by grasping the item with both hands and pulling at right angles to the seam. Areas to be repaired shall be marked with crayon. Non-specification and personnel marks shall be erased or obscured.
 - (2) Dry cleaning and mothproofing treatment. Dry cleaning will be accomplished in accordance with TM 10-300 when cleaned in Army facilities, if cleaned by contract using commercial facilities, the cleaning will be accomplished in accordance with commercial dry-cleaning practices. The procedure for mothproofing woolen items by dry cleaning is found in TM 10-300.
 - (3) Sewing machine repairs, stitching and restitching. All sewing, except emergency repair, shall be machine sewn. When ends of machine stitching type 301 are not caught in other seams or stitching, they shall be back-stitched not less than 1 inch at each break. Ends of a continuous line of stitching shall overlap not less than $\frac{1}{2}$ inch (1.27 cm). Thread breaks (all stitch types) shall be repaired by stitching back of the break not less than $\frac{1}{2}$ inch (1.27 cm) at end of break. Thread tension shall be properly maintained to avoid loose stitching and locks shall be imbedded in the center of the materials sewn. Thread breaks in overedge stitching shall be overlock stitched not less than $\frac{3}{4}$ inch (1.91 cm) at each end of break. Stitch spacing used for restitching and other types of seams, shall be the same as in the original construction. Seams with loose and/or weak thread shall be restitched. For illustrations of the various types of stitches used, see FED-STD-751. The following types of stitch, thread size, and stitches per inch are to be used as applicable to the repair (see table 5-1).
-

5-6. REPAIR AND MAINTENANCE OF UNIFORMS - Continued

Table 5-1. Stitching Instructions

LOCATION	STITCH STYLE	THREAD		STITCHES PER INCH	
		NEEDLE	BOBBIN	SHIRT	TROUSERS
General	301	50/3	50/3	10-14	12-16
General	401	50/3	50/3	10-14	12-16
Overedge	502 504	50/3	50/3	6-10	
*Bartacks	Bartacks	50/3	50/3	28 Per bartack	
*Buttonholes	Buttonholes	50/3	50/3	44-46 per buttonhole	
*Buttons	101 or 301	50/3	-----	20-24 per buttonhole	
*Eyelets	Eyelet machine	50/3	50/3	1924 per eyelet	

* May be repaired by hand using double ply of 50/3 thread.

- (4) Patching and darning. Patching and darning may be applied to any areas of the two items. Repair small tears not more than ½ inch (1.27 cm) across with a darning or zigzag stitch. Patch holes having a diameter of ¼ Inch (0.635 cm) or more. Repair rips, tears, and thin areas greater than ½ inch (1.27 cm) by patching. Patches shall be limited to a maximum of 2 inches (5.08 cm) in the greatest dimension. Patches shall match the garment in color and type of material. Insert patch under the damaged area; cut away damaged area and turn edges under approximately 3/8-inch (0.955 cm) turn-under of all edges except selvage edges. Pre-cut all patches to provide for symmetry. Materials shall be those specified in section III.
- (5) Buttons. Replace buttons that are missing, broken or damaged. Buttons are the 30 line, style 26 and should work freely and fit properly in the buttonholes.
- (6) Buttonholes. Repair buttonholes by reshaping enlarged buttonholes before reworking them and then pulling them into shape by hand or machine whipping a small reinforcement patch to the underside of the garment. Rework the buttonhole through the reinforcement patch.
- (7) Pockets. Darn or patch corners that are damaged. Attach new pockets of matching shade by machine and in the same manner as those removed. Remove trouser pockets that are badly damaged and replace with new pockets fabricated from material specified in section III. Alternate method of pocket repair is to cut off damaged end of the pocket. Replace that portion of the pocket with one having the same length and made from new material.
- (8) Hems. Bottom of frayed trouser legs will be neatly trimmed, turned under, and stitched in place.
- (9) Belt Loops. Replace missing, broken, or torn belt loops with new loops fabricated of basic material specified in section III.

5-6. REPAIR AND MAINTENANCE OF UNIFORMS - Continued

- (11) Slide fasteners. Replace defective fasteners with those specified in section III.
- (12) Buckles. Replace defective or missing buckles with serviceable buckles from salvaged trousers or new buckles specified in section III.
- (13) Resizing. Resize all garments after complete repair and cleaning according to the item group schedule of sizes listed in table 5-2. When items deviate in size from original marking, obliterate the old marking and print or stamp the proper size with an indelible pencil or waterproof ink near the old size. When the measurements do not correspond to a size listed, remark items to correspond to the next lowest size. Items with measurements falling below the lowest measurement in the schedule will not be accepted as conditioning.

Table 5-2. Men's Wool Shirt Resizing Instructions

(Finished measurements in inches)

SIZE	BREAST*	SLEEVE ** LENGTH	BACK *** LENGTH
X-Small	18	34	29
Small	20	35	29 ½
Medium	22	36	30
Large	24	37	30 ½
X-Large	26	38	31
Tolerance	±½	±¾	±¾

* One-half breast measurement taken, with shirt buttoned, from folded edge to folded edge in line with base of armhole of back part.

** Sleeve length shall be measured from center back at collar seam, diagonally across back and down sleeve to bottom edge of cuff.

*** Back length shall be measured at center back from collar seam line to bottom of shirt.

5-7. WORKMANSHIP

All work shall be accomplished by personnel skilled in the particular trade applicable to their duties in the repair of subject items. Darning shall be neatly accomplished and patches shall be of the proper size and firmly stitched to the garments. Stitching and reseaming shall be secure, and loose ends shall be turned and removed. Buttons, buckles, and belt loops shall be securely and properly attached to function as intended. The finished items shall be complete and well repaired, thoroughly cleaned, and free from all defects which may affect serviceability or general appearance.

5-7. WORKMANSHIP - Continued**Table 5-3. Men's Wool Trousers Resizing Instruction**

(Finished measurements in inches)

SIZE	WAIST *	SEAT **	INSEAM ***
Short X-Small	14 1/8	19 7/8	28
Regular X-Small	14 1/8	19 7/8	31
Long X-Small	14 1/8	19 7/8	34
Short Small	16 1/8	21 7/8	28
Regular Small	16 1/8	21 7/8	31
Long Small	16 1/8	21 7/8	34
Short Medium	18 1/8	23 7/8	28
Regular Medium	18 1/8	23 7/8	31
Long Medium	18 1/8	23 7/8	34
Short Large	20 1/8	25 7/8	28
Regular Large	20 1/8	25 7/8	31
Long Large	20 1/8	25 7/8	34
Short X-Large	22 1/8	27 7/8	28
Regular X-Large	22 1/8	27 7/8	31
Long X-Large	22 1/8	27 7/8	34
Tolerance	+1/2 -1/4	+3/4 -1/2	+3/4 -1/2

* Waist - Trousers buttoned and flat, measured from side fold to side fold at top of waist.

** Seat - Trousers measured from side fold to side fold along fly bartack

*** Inseam - Trousers measured from crotch seam to bottom of hem.

5-8. INSPECTION

The inspection quality control unit is responsible for determining compliance with repair instructions and requirement for classification. In-process inspections will be performed for quality of workmanship and correct application of repair procedures. The completed item will be inspected for serviceable appearance and condition to insure against return of a substandard product to supply channels.

Section III. MATERIALS

SMR CODE	NATIONAL STOCK NUMBER	DESCRIPTION	UNIT OF ISSUE
PAFZZ	8305-00-261-8194	Cloth, Flannel Wool And Nylon; OG108, 16 Ounce; Conform to MIL-C-11065.	YD
PAFZZ	8310-00-262-0094	Gimp; Olive Drab, Shade S-1, Cable No. 66022, Conform to Type I of II, No. 8 of V-T-280	SL
PAOZZ	8315-00-899-0029	Buttons; OG Shade BP, C.A. 62016, Dull Finish, 30 Line, Type II Class D, Conform to Style 26 of V-B-871	GR
PAOZZ	8310-00-187-3920	Thread, Cotton; Type 1A3, Olive Drab, Shade S-1, Cable No. 66022, Ticket No. 50, 3 Ply of V-T-276.	CE
PAFZZ	8315-00-253-6279	Tape, Textile, Cotton; Type 1, Class 3, 1 ½ inches In Width, Olive Drab 7, Conform to MIL-T-43566.	YD
XBFZZ		Loops, Suspender; Nylon Laces, OD No. 7, Conform to Type I, Class I of V-L-61. Must be Cannibalized From Unrepairable Trousers.	
PAFZZ		Tape, Slide Fastener; Shade S, Conform to Type I, Style 1, Camlock, Size LM of V-F-106.	
PAOZZ	8310-00-066-0973	Thread, Polyester Core, Cotton-Rayon, or Polyester-Covered, Olive Drab, C.A. 66022 Part No. MIL-T-43548 (81349)	CE
PAFZZ	8305-00-763-5525	Cloth, Twill, Polyester & Cotton Conforming to Class 1 of MIL-C-43718, Unbleached.	YD
PAFZZ	8305-00-261-8140	Cloth, Nylon, Oxford, OG-106, Conforming to Type I, Class 1 of MIL C-508.	YD

CHAPTER 6

MAINTENANCE OF SNOW CAMOUFLAGE PARKA AND TROUSERS

Section I. Introduction

6-1. SCOPE

This chapter provides instructions and prescribes the materials, methods, and procedure for the repair and maintenance of snow camouflage parkas and trousers. It includes illustrations for identification and clarification of repair operations and methods.

6-2. SPECIFICATIONS AND PUBLICATIONS

a. Items

SPECIFICATION	ITEM
MIL-P-10809 MIL-T-43654	Parka, Snow Camouflage Trousers, Snow Camouflage White, Arctic

b. Components.

SPECIFICATION	ITEM
V-B-871 V-F-106 V-T-280 DDD-L-20 MIL-B-371 MIL-B-3530 MIL-F-10884 MIL-C-43303 MIL-T-43566 A-A-50199 MIL-C-44431	Button, Sewing Hole and Button, Staple, (Plastic) Fasteners, Slide, Interlocking Thread, Gimp, Cotton, Buttonhole Label For Clothing, Equipage and Tentage, (General Use) Braid, Textile, Tubular Thread and Twine Mildew Resistant or Water Repellent Treated Fasteners, Snap Cord, Elastic, Cotton Tape, Textile, Cotton-Covered and Rayon Covered Thread, Polyester Core, Cotton- or Polyester-Covered Cloth, Plain Weave, Nylon Filament, Lightweight

c. Publications.

NUMBER	TITLE
FM 10-16 FM 10-280 FED-STD-751	General Fabric Repair Field Laundry, Bath and Clothing Exchange Operations Stitches, Seams, and Stitchings

6-3. IDENTIFICATION AND DESCRIPTION

a. Parka, Snow Camouflage

NSN	SIZES	SPECIFICATION
8415-00-223-7625	Small	MIL-P-10809
8415-00-223-7628	Medium	MIL-P-10809
8415-00-223-7627	Large	MIL-P-10809
8415-00-223-7980	X-Large	MIL-P-10809

The parka (Figure 6-1) is made of multi filament nylon material. The garment repels water, is lightweight and totally compatible with the Extended Cold Weather Clothing System (ECWCS). The parka has an intergal hood with draw cord and cord locks (barrel locks), two pass through pockets, and waist and bottom hem draw cords. The parka front closure system utilizes five snap fasteners. There is one snap fastener at the base of the hood (near the neck line). This item includes an attached storage pouch. The garment is stuffed in this pouch when it is not being worn. The storage pouch fits easily in one of the ECWCS Parka pockets or the soldiers field pack. The various garment sizes with fitting guidelines are listed in Tables 6-6 and 6-7.

LEGEND

- 1 Cloth, Plain Weave, Nylon Filament
- 2 Braid, Textile, Tubular, Draw Cords
- 3 Cord, Elastic, Wrist Cuffs
- 4 Thread Polyester Core
- 5 Snap Fastener, Male
- 6 Snap Fastener, Female
- 7 Label
- 8 Cord Lock, Hood
- 9 Storage Pouch

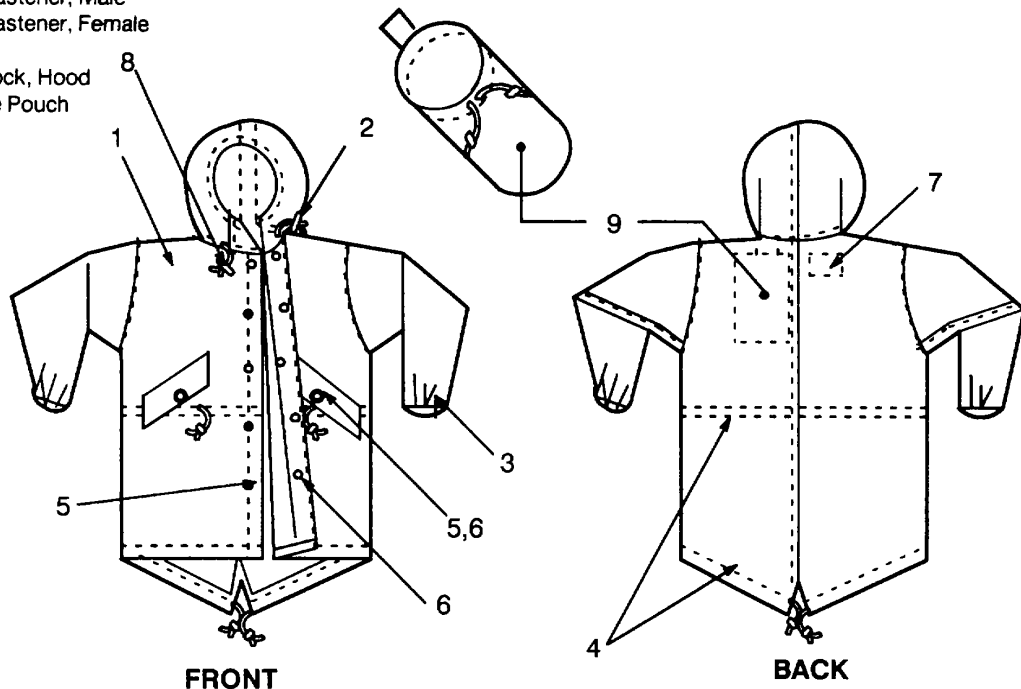

LEGEND

- 1 Cloth, Plain Weave, Nylon Filament
- 2 Braid, Textile, Tubular, 4/32 inch
- 3 Braid, Textile, Tubular, 6/32 inch, Suspender Loops
- 4 Tape, Textile, 1-inch, Button Tabs
- 5 Cord, Elastic, Leg Cuffs
- 6 Thread Polyester Core
- 7 Snap Fastener, Male
- 8 Snap Fastener, Female
- 9 Button
- 10 Label
- 11 Cord Lock
- 12 Slide Fastener (Fly)
- 13 Slide Fastener (Leg Gusset)
- 14 Storage Pouch

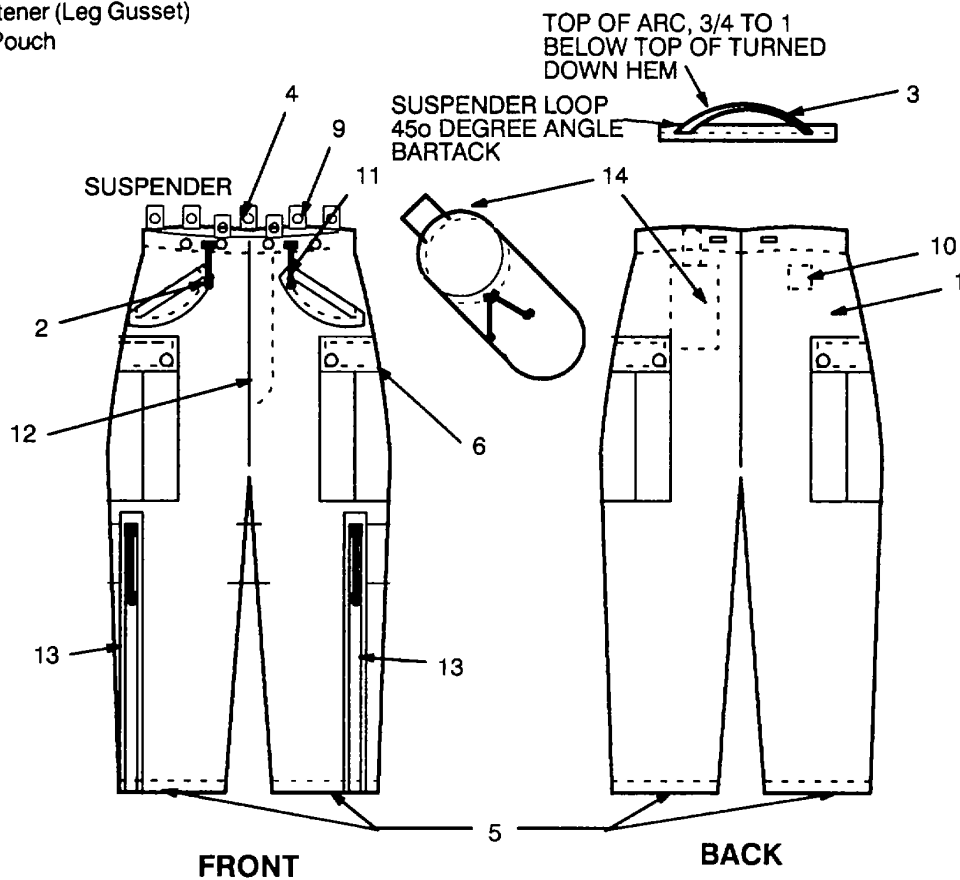

Figure 6-2. Trousers, Snow Camouflage, White, Arctic

6-3. IDENTIFICATION AND DESCRIPTION - Continued

b. Trousers, Snow Camouflage, White, Arctic.

NSN	SIZES	SPECIFICATION
8415-00-935-0567	X-Small Regular	MIL-T-43654
8415-00-935-0568	Small Short	MIL-T-43654
8415-00-935-0569	Small Regular	MIL-T-43654
8415-00-935-0570	Small Long	MIL-T-43654
8415-00-935-0571	Medium Short	MIL-T-43654
8415-00-935-0572	Medium Regular	MIL-T-43654
8415-00-935-0573	Medium Long	MIL-T-43654
8415-00-935-0575	Large Long	MIL-T-43654
8415-00-935-0576	X-Large Regular	MIL-T-43654
8415-00-935-0577	X-Large Long	MIL-T-43654

The trousers (Figure 6-2) are made of multi-filament nylon material. The garment repels water, is lightweight and totally compatible with the Extended Cold Weather Clothing System (ECWCS). The trousers have pass through pockets and cargo pockets with snap closures, a waist drawer cord, six button tabs at the waist and suspender loops. The button tabs are used with the white extreme cold weather quilted trouser liner. This white trouser liner is part of the Dry-Extreme Cold Weather Clothing System. The Extended Cold Weather Clothing System (ECWCS) which replaces the latter does not utilize the button tabs and white trouser liner. Leg openings are provided to don and doff the item without removing the soldiers Vapor Barrier Boots (VB Boots). The leg openings close by means of a slide fastener This item includes and attached storage pouch. The garment is stuffed in this pouch when it is not being worn. The storage pouch fits easily in one of the ECWCS Parka pockets or the soldiers field pack. The various garment sizes with fitting guidelines are listed in table 6-3.

Section II. MAINTENANCE PROCEDURE

6-4. MATERIALS

Materials used to repair the Parka and Trousers shall be serviceable materials recovered from similar salvaged items or new materials that conform to the specifications listed in Section III.

6-5. CLASSIFICATIONS

Serviceability classification for the Parka and Trousers shall be determined in accordance with Chapter 1.

6-6. CLEANING AND LAUNDERING

a. Machine/Hand Laundering. The parka and trousers are to be laundered in wash and wear setting/warm water (120°F) with phosphate detergent when not restricted, rinse three times, wash darks separately. Dry the parka and trousers by tumble drying at the permanent press setting (temperature not to exceed 90°F) or use a clothes rack, line, or non-metal hanger to drip dry the item.

CAUTION

Do not use Chlorine bleach or starch. Discoloration and degradation of infrared protection capacity of the material will result.

b. Field Laundering. The parka and trousers are to be laundered using formula II of FM 10-280. Dry the parka and trousers by tumble drying at the permanent press setting (temperature not to exceed 90°F). Do not press this item.

6-7. REPAIR

a. General. Prior to repair operations, each item shall be inspected by qualified personnel to determine the extent of repair necessary. All repairs to the components of the parka and trousers will be accomplished at the direct support level FM 10-16 will be used as a general guide.

b. Repair Procedures.

(1) Preliminary Examination. Remove all dirt, mud, dust, spots, stains and other foreign matter with a brush before examining the garment. Rotten items will be discarded. Seams will be tested by grasping the item with both hands and pulling at right angles to the seams. Areas to be repaired shall be marked with crayons. Nonspecific and personal marks shall be erased or obliterated.

(2) Rips and tears. Any rip or tear closer than $\frac{3}{4}$ inch to any seam will be repaired by sewing. Other rips, tears or stress points (pockets) may be repaired by heat seal patches in all directions beyond the tear or other damage.

- (a) Patch size. The heat seal patch should be selected from commercial pre-cut patches such that, when applied, it will extend approximately $\frac{3}{4}$ inch in all directions beyond the tear or other damage and will have rounded corners. Pre-cut patches in several sizes may be used.
- (b) Patching procedure. When patching the parka by hand iron or automatic heat seal mending equipment, place the garment area to be patched on an ironing board. Patches shall be applied to the inside of the garment. The garment may be turned inside out or the patch may be inserted within the garment, taking care that the patch is centered in the desired position. Trim all ravelled ends with scissors. Smooth out the area to be patched so that the tear is closed or very near closed, and so that there will be no wrinkles, folds, seams, or other protrusions under the iron when it is applied. Pre-warm the area to be patched by pressing with a household electric dry iron or steam iron used in the dry mode. Set the iron heat selector for cotton and apply the iron for five seconds or more (avoid scorching the fabric). Immediately position the patch of the desired size and shape. Hold the iron on the patch for about twelve seconds. Use no more than a slight rotating or reciprocal motion of the iron and apply constant pressure. Remove the iron and allow the patched area to cool in place, about five seconds, or long enough so that the patch will not lift off when the garment is removed from the ironing board. Patches that are longer than the iron may be ironed in sections, starting at the center and completing each section before proceeding to the next section. Overlapping of the iron upon a previously bonded section is permissible. Carefully trim away any frayed protrusions at the torn edges. When available, use automatic heat seal equipment in lieu of a hand iron.

6-7. REPAIR-Continued

- (c) Quality control. Adjust heating, pressing, and cooling times as required for the specific iron or automatic heat seal mending equipment being used. Check the quality of the adhesive bond periodically and adjust heating times and temperatures of the heating plate as follows:

Check test. Periodically during the work and when adjusting the iron, test a patch which has cooled for about five minutes by picking with the fingers at an edge of the patch until a tab about ¼ to ½ inch long is formed. Pull hard on the tab with fingers. A well-bonded tab will be difficult to peel off and will indicate that iron adjustment and heating time are adequate. Replace the check test patch with a new patch.

1. If the adhesive strikes through the patch cloth, too much heat has been applied. Reduce time of pressing or temperature of the iron. A small amount of strike through is not objectionable provided the patch meets the about cited check test
2. A bonded patch which has lifted edges will be ironed. A bonded patch which has been subjected to the check test will be replaced.
3. When patching by a special automatic press, the platen, temperature, dwell time, dwell pressure, and other details should be in accordance with the press manufacturer's instructions.

(3) Stitching and restitching. The location, stitch type, thread size, and stitches per inch for the parka and trousers are listed in tables 6-1. All stitches, seams, and stitching shall conform to FED-STD-751. Seam allowances shall be maintained with seams sewn so no raw edges, run-offs, pleats, puckers, or open seams occur except where they are supposed to occur (pleats in the trousers knees). When two or more methods of stitching are given for the same operation, any or one may be used.

Table 6-1. Stitching Instructions (Parka and Trousers)

OPERATION	STITCH TYPE	THREAD SIZE		STITCHES PER INCH
		NEEDLE	BOBBIN	
Parka:				
General	301	30	30	10 - 13
Assembling hood	301 or 401	30	30	10 - 13
Bartacking:	3/8 to ½ inch	30	30	28 per tack
Draw cord center back hood, vent opening center back seam, hood attachment seam ends, and bottom hem ends				
Eyelet	502 or 503	50	50	26-32 per eyelet
Overedge stitch for storage pouch	515 or 516	30	30	10 - 13

6-7. REPAIR-Continued

Table 6-1. Stitching Instructions (Parka and Trousers) - Continued

OPERATION	STITCH TYPE	THREAD SIZE		STITCHES PER INCH
		NEEDLE	BOBBIN	
Trousers:				
General	301	30	30	10 - 13
Assembling front fly	504 or 516	30	30	10 - 13
Bartacking:	3/8 to 5/8 inch	30	30	28 per tack
Assembly and attachment of waistband button tabs, waistband tunnel ends, attachment of suspender loops				
bellows pockets:				
Horizontally across fold pleats and vertically at edge of bellows, opposite top edge of pocket, and bottom pocket edge on bellows side				
Eyelet	502 or 503	50	50	26 - 32 per eyelet
Overedge stitch for storage pouch	515 or 516	30	30	10-13

(4) Repair of 301 stitching. Ends of all stitching shall be backstitched or overstitched not less than 1/2 inch except where ends are turned under or caught in other seams or stitching. Ends of a continuous line of stitching shall overlap not less than 1/2 inch. Thread tensions shall be maintained so that there will be no loose stitching resulting in loose bobbin or top thread or excessively tight stitching resulting in puckering of materials sewn. The lock shall be embedded in the materials sewn. When thread breaks, skipped stitches, run-offs, or bobbin runouts occur during webbing stitching shall be repaired by restarting the stitching a minimum of 1/2 inch back of end of the interrupted stitching. Except for prestitching, thread breaks of two or more consecutive skipped or run-off stitches noted during inspection of the item shall be repaired by overstitching. The stitching shall start a minimum of 1/2 inch in back of defective area, continue over the defective area and a minimum of 1/2 inch beyond defective area onto the existing stitching. Loose or excessively tight stitching shall be repaired by removing defective stitching without damaging the materials, and restitching in the required manner. When making above repairs, ends of stitching need not be backstitched.

6-7. REPAIR - Continued

(5) Type 401, 502, 503, 515, and 516 stitching. These type stitchings are repaired in the same manner as type 301, except that repairs to type 401 stitching requires both ends of all seams to have a 1/2 inch minimum chain extending beyond each end unless they are caught in a seam or other stitching.

(6) Bartacks. Unless otherwise specified, all bartacks shall be 3/8 to 5/8 inch long and 1/8 ± 1/16 inch wide, and shall contain 28 stitches. Bartacking shall be free from thread breaks and loose stitching.

(7) Slide Fasteners. Replace damaged, missing, or malfunctioning slide fasteners with serviceable ones. Slide fasteners are not seam-sealed in, remove the one to be replaced and sew in a new one. All sizes for trouser slide fasteners are listed in table 6-4.

(8) Snap Fasteners. Replace missing, loose, or damaged snap fasteners. Patch damaged area surrounding snap fastener sockets and studs prior to attaching snap fasteners.

(9) Drawcords and Barrel Locks. Replace missing or defective drawcords in lengths to match original construction. Drawcord ends shall be heat seared and knotted. Refer to tables 6-2 and 6-3 for proper lengths. Replace Barrel Locks as required.

(10) Elastic Webbing. Replace defective elastic webbing at bottom of sleeves and legs. Legs for webbing are listed in tables 6-2 and 6-3.

(11) Pocket Flaps. Repair or replace torn, missing, or defective flaps. Restitch ripped seams or loose stitching.

Table 6-2. Drawcord and Tape Lengths (Parka)

ITEM	X-SMALL IN	SMALL IN	MEDIUM IN	LARGE IN	X-LARGE IN	TOLERANCE IN
Hood	50	50	50	50	50	±1
Waist	56	60	64	68	72	±1
Bottom Hem	41	42	44	46	48	±1
Pouch	22	22	22	22	22	±1
Elastic for Sleeve	10	10	10	10	10	±1

Table 6-3. Drawcord and Tape Lengths (Trousers)

ITEM	X-SMALL IN	SMALL IN	MEDIUM IN	LARGE IN	X-LARGE IN	TOLERANCE IN
Waist	38	42	46	50	54	±1
Pouch	22	22	22	22	22	±1/2
Button Tab						
1" Tape	4	4	4	4	4	±1
Suspender Loop 1/4"						
Tape	6	6	6	6	6	±1
Elastic for Leg Hem	10 3/4	10 3/4	10 3/4	10 3/4	10 3/4	±1

6-7. REPAIR - Continued**Table 6-4. Slide Fastener Lengths (Trousers)**

Trouser Size	Front Fly Length (In)	Leg Opening Length (In)
X-Small Short	9- ³ / ₄	17 5/8
X-Small Regular	10- ¹ / ₄	20 5/8
X-Small Long	10- ³ / ₄	20 5/8
Small Short	10- ¹ / ₄	17 5/8
Small Regular	10- ³ / ₄	20 5/8
Small Long	11- ¹ / ₄	20 5/8
Medium Short	10- ³ / ₄	17 5/8
Medium Regular	11- ¹ / ₄	20 5/8
Medium Long	11- ³ / ₄	20 5/8
Large Short	11- ¹ / ₄	17 5/8
Large Regular	11- ³ / ₄	20 5/8
Large Long	12- ¹ / ₄	20 5/8
X-Large Short	11- ³ / ₄	17 5/8
X-Large Regular	12- ¹ / ₄	20 5/8
X-Large Long	12- ³ / ₄	20 5/8

(12) Pockets. Restitch loose or ripped pockets. Replace missing or defective pockets with new ones using cloth conforming to MIL-C-44431, Cloth, Plain Weave, Nylon Filament, Lightweight. To attach pockets and flaps to fronts, turn in edges of pockets ½ inch if not prehemmed. Position pockets and stitch 1/16 to 1/8 inch from folded edge around sides and bottom, tacking tops. Position breast pocket flap above pockets so line of stitching will lay away from pocket. Stitch to fronts 3/16 to ¼ inch from overedged edge. Turn flap sown and raise stitch ¼ to 5/16 inch from fold, tacking ends. Turn pocket opening side of handwarmer pockets on shirt to inside and stitch 3/8 to ½ inch from folded edge for hem. Position handwarmer pockets, turning seam allowance under and stitch 1/8 to 3/16 inch from folded edges.

(13) Eyelets. Darn eyelet holes with polyester thread as needed.

6-8. RESIZING

After cleaning and repair, resize garments according to sizes listed in Tables 6-5 through 6-8 below. When garments vary in size from original marking, obliterate old marking and re-mark with proper size using indelible pencil or waterproof ink. When actual measurements do not correspond to the size indicated, relabel to the next lowest size.

Table 6-5. Finished Measurements (Parka)

SIZE	½ Chest¹ In	Back Length² In	Sleeve Length³ In
X-Small	28 ½	38	27 ½
Small	30 ½	38 ½	27 ¾
Medium	32 ½	39	27 7/8
Large	34 ½	39 ½	28
X-Large	36 ½	40	28 1/8
Tolerance	±½	±¼	±½

¹With parka closed and smoothed flat, measure ½ chest from folded edge to folded edge at base of armhold seams.

²Measure center back length from neck seam to bottom of vent opening.

³Measure sleeve length from center sleeve-setting at shoulder to bottom edge of sleeve.

Table 6-6. Finished Measurements (Trousers)

Size	½ Waist¹ In	Inseam² In	Outseam³ In	½ Knee⁴ In	½ Bottom⁵ In
Short					
X-Small	16	25 ½	38	13 7/8	12
Small	18	25 ½	39	14 ½	12 ¼
Medium	20	25 ½	39 ½	15 ¼	12 ½
Large	22	25 ½	40	16	12 ¾
X-Large	24	25 ½	40 ½	16 5/8	13
Regular					
X-Small	16	28 ½	42	13 7/8	12
Small	18	28 ½	42 ½	14 ½	12 ¼
Medium	20	28 ½	43	15 ¼	12 ½
Large	22	28 ½	43 ½	16	12 ¾
X-Large	24	28 ½	44	16 5/8	13
Long					
X-Small	16	31 ½	45 ½	13 7/8	12
Small	18	31 ½	46	14 ½	12 ¼
Medium	20	31 ½	46 ½	15 ¼	12 ½
Large	22	31 ½	47	16	12 ¾
X-Large	24	31 ½	47 ½	16 5/8	13
Tolerance	±½	±¾	±¾	±½	±½

¹Measurement taken along top edge of waist from folded edge to folded edge with front snap fastener secured.

²Measurement taken from center of crotch seam to bottom edge of leg trouser flat, measure from top of waistband to trouser leg hem.

³Measurement taken from top of waist to bottom of trousers along outseam.

⁴Measurement taken between knee pleats across knee from folded edge to folded edge.

⁵Measurement taken across bottom of leg from folded edge to folded edge.

6-8. RESIZING - Continued**Table 6-7. Parka Sizes**

<u>X-Small</u>	<u>Small</u>	<u>Medium</u>
Chest Mn: Up to 33 in	Chest Mn: 33 to 37 in	Chest Mn: 37 to 41 in
Chest Wn: Up to 36 in	Chest Mn: 33 to 37 in	Chest Wn: 40 to 44 in
NSN: None	Chest Wn: 36 to 40 in	NSN: 8415-00-223-7628
NATO Size: 7080/7484	NSN: 8415-00-223-7625	NATO Size: 7080/9404
	NATO Size: 7080/1424	
<u>Large</u>	<u>X-Large</u>	
Chest: 41 to 45 in	Chest: From 45 inches and up	
NSN: 8415-00-223-7627	NSN: 8415-00-268-7980	
NATO Size: 7080/0414	NATO Size: 7080/1424	

Table 6-8. Trousler Sizes

<u>X-Small Short</u>	<u>X-Small Regular</u>
Inseam: Up to 29 ½ in	Inseam: 29 ½ to 32 ½ in
Waist: Below 27 inches	Waist: Below 27 inches
NSN: None	NSN: 8415-00-935-0567
NATO Size: 6975/6469	NATO Size: 7583/6469
<u>X-Small Long</u>	<u>Small Short</u>
Inseam: Over 32 ½ inches	Inseam: Up to 29 ½ in
Waist: Below 27 Inches	Waist: 27 to 31 inches
NSN: None	NSN: 8415-00-935-0568
NATO Size: 8386/6469	NATO Size: 6975/6979
<u>Small Regular</u>	<u>Small Long</u>
Inseam: Over 29 ½ in	Inseam: Over 32 ½ inches
Waist: 27 to 31 inches	Waist 27 to 31 inches
NSN: 8415-00-935-0569	NSN: 8415-00-935-0570
NATO Size: 7583/6979	NATO Size: 8386/6979
<u>Medium Short</u>	<u>Medium Regular</u>
Inseam: Up to 29 ½ in	Inseam: 29 ½ to 32 ½
Waist: 31 to 35 inches	Waist: 31 to 35 in
NSN: 841-00-935-0571	NSN: 8415-00-935-0572
NATO Size: 6975/7989	NATO Size: 7583/7989
<u>Medium Long</u>	<u>Large Short</u>
Inseam: Over 32 ½ in	Inseam: Up to 29 ½ in
Waist: 31 to 35 in	Waist: 35 to 39 in
NSN: 8415-00-935-0573	NSN: None
NATO Size: 8386/7989	NATO Size: 6975/8999
<u>Large Regular</u>	<u>Large Long</u>
Inseam: 29 ½ to 32 ½ in	Inseam: Over 32 ½ in
Waist 35 to 39 in	Waist 35 to 39 in
NSN: 8415-00-935-0574	NSN: 8415-00-935-0575
NATO Size: 7583/8999	NATO Size: 8386/8999
<u>X-Large Short</u>	<u>X-Large Regular</u>
Inseam: Up to 29 ½ in	Inseam: 29 ½ to 32 ½ in
Waist: 39 to 43 inches	Waist: 39 to 43 in
NSN: None	NSN: 8415-00-935-0576
NATO Size: 6975/9909	NATO Size: 7583/9909
<u>X-Large Long</u>	
Inseam: Over 32 ½ inches	
Waist: 39 to 43 inches	
NSN: 8415-00-935-0577	
NATO Size: 8386/9909	

6-9. WORKMANSHIP

All work shall be accomplished only by qualified personnel. The finished garments shall be completed, clean, and free from defects affecting their serviceability and appearance. Sealed seams and stitching shall show no leakage when tested. Threads shall be neatly trimmed. Drawcords shall not be missing or caught in hem, tunnel, or waist- band stitching. Drawcords shall be of sufficient lengths with ends heat seared and knotted. Slide fasteners shall close properly, be of specified length and color, and contain thongs as specified. Seams shall not be twisted, pleated, or puckered. Stitch tension shall be adequate, not loose or tight, with specified number of stitches per inch on major portions of seam. The material shall not be defective or damaged in any manner. The material shall not contain cuts, tears, mends, burns, needle chews or holes.

6-10. INSPECTION

The inspection or quality control unit is responsible for determining compliance with repair instructions and requirements for classification. In-process inspections shall be performed for quality of workmanship and correct application of repair procedures. The completed item will be inspected for serviceable condition and appearance to ensure against return of substandard products to supply channels.

Section III. MATERIALS

FIG. NO.	ITEM NO.	SMR CODE	NSN	DESCRIPTION	UNIT OF ISSUE
6-1	1	XBFZZ		PARKA, SNOW CAMOUFLAGE (Figure 6-1) Cloth, Plain Weave, Nylon Filament, Lightweight conforming to MIL-C-44431	YD
6-1	2	PAFZZ	8315-00-240-2147	Braid, Textile, Tubular, Natural conforming to type IV, .125 Dia, class 2 of MIL-B-371. The ends of the draw cords shall be dipped or impregnated with cellulose acetate, or cellulose acetate butyrate.	YD
6-1	3	PAFZZ		Cord, Elastic, Cotton, MIL-C-43303, Class 2, 3/16 Inch, bleached or unbleached.	YD

Section III. MATERIALS

FIG. NO.	ITEM NO.	SMR CODE	NSN	DESCRIPTION	UNIT OF ISSUE
6-1	4	PAFZZ	8310-01-118-8167	Thread, Polyester Core, Cotton- or Polyester Covered conforming to A-A-50199, ticket nos. 30 (needle) and 50 (looper), 2 or 3 ply, Bleached White AH, C.A. 66050. The Thread shall be water repellent treated in accordance with type II, class 3 of MIL-T-3530; Thread and Twine: Mildew Resistant or Water Repellent Treated	CN
6-1	5	PAFZZ		Fastener, Snap; socket and eyelet parts, style 2A finish 6, size 1 or 2 conforming to MIL-F-10884	EA
6-1	6	PAFZZ		Fastener, Snap: button and stud parts, style 2A finish 6, size 1 or 2 conforming to MIL-F-10884	EA
6-1	7	XBFZZ		Label- For Clothing Equipage and Tentage (General Use) class 1 identification label, class 2 size label and class 3 instruction label type VI, or a class 14 combination label for size, identification, and instruction, type VI of DDD-L-20. Source: E I. DuPont de Nemours and Co. Inc. Textile Fiber Department Wilmington, Delaware 19898	EA
6-1	8	PAFZZ		Cord Lock; US Army Natick Drawing 2-6-104, Black. ITW Nexus Barreloc or equivalent FSCM 02768 Source: ITW 230 Gerry Dr., Wood Dale, IL 60191	EA

Section III. MATERIALS

FIG. NO.	ITEM NO.	SMR CODE	NSN	DESCRIPTION	UNIT OF ISSUE
6-2	1	XBFZZ		TROUSERS, SNOW CAMOUFLAGE, WHITE, ARCTIC (Figure 6-2) Cloth, Plain Weave, Nylon Filament, Lightweight conforming to MIL-C-44431	YD
6-2	2	PAFZZ	8315-00-240-2147	Braid, Textile, Tubular conforming to type IV, class 2, .125 inch, bleached or natural of MIL-B-371 for draw-cords. The ends of the draw-cords shall be dipped or impregnated with cellulose acetate, or cellulose acetate butyrate.	YD
6-2	3	PAFZZ		Braid, Textile, Tubular conforming to type III, class 2, .188 inch, bleached or natural, of MIL-B-371 for slide fastener thong and suspender loops. The ends of the draw-cords shall be dipped or impregnated with cellulose acetate, or cellulose acetate butyrate.	YD
6-2	4	PAFZZ	8315-00-254-0185	Tape, Textile, Cotton, General Purpose, Natural or Colors, 1-inch wide conforming to type I, class I (natural) or type I, class 2 (bleached) of MIL-T-43566.	YD
6-2	5	XBFZZ		Cord, Elastic, Cotton, conforming to class 2 of MIL-C-43303, bleached or unbleached, 3/16 inch	YD

Section III. MATERIALS

FIG. NO.	ITEM NO.	SMR CODE	NSN	DESCRIPTION	UNIT OF ISSUE
6-2	6	PAFZZ	8310-01-118-8167	Thread, Polyester Core, Cotton- or Polyester Covered conforming to A-A-50199, ticket nos. 30 (needle) and 50 (looper), 2 or 3 ply, Bleached White AH, C.A 66050. The Thread shall be water repellent treated in accordance with type II, class 3 of MIL-T-3530, Thread and Twine: Mildew Resistant or Water Repellent Treated	CN
6-2	7	PAFZZ		Fastener, Snap, socket and eyelet parts, style 2A finish 6, size 1 or 2 conforming to MIL-F-10884	EA
6-2	8	PAFZZ		Fastener, Snap; button and stud parts, style 2A finish 6, consisting of stud and eyelet size 1 or 2 conforming to MIL-F-10884	EA
6-2	9	PAFZZ	8315-00-773-4300	Button, Sewing Hole, and Button, Staple, (Plastic) conforming to type II, class D, style 26, 30 line, White BA, Cable 62031, dull finish, V-B-871	GR
6-2	10	XBFZZ		Label For Clothing Equipment and Tentage (General Use) Class I identification label, class 2 size label and class 3 instruction label type VI, or a class 15 combination label for identification and instruction, type VI or a class 14 combination label for size, identification, and instruction, type VI of DDD-L-20. Source E.I. DuPont de Nemours and Co. Inc. Textile Fiber Department Wilmington, Delaware 19898	EA

Section III. MATERIALS

FIG. NO.	ITEM NO.	SMR CODE	NSN	DESCRIPTION	UNIT OF ISSUE																																
6-2	11	PAFZZ		Cord Lock; US Army Natick Drawing 2-6-104, Black. ITW Nexus Barreloc or equivalent. FSCM 02768 Source: ITW 230 Gerry Dr., Wood Dale, IL 60191	EA																																
6-2	12	PAFZZ		<p>Fastener, Slide, interlocking; white, type I style 3, size MS, nylon or polyester continuous coil or ladder configuration, with thong, black tape, Conforming to V-F-106 lengths corresponding to the trouser sizes indicated below: (See size code legend at the end of Section III)</p> <table data-bbox="711 940 987 1430"> <thead> <tr> <th>Size</th> <th>Inch</th> </tr> </thead> <tbody> <tr><td>XSS</td><td>9 3/4</td></tr> <tr><td>XSR</td><td>10 1/4</td></tr> <tr><td>XSL</td><td>10 3/4</td></tr> <tr><td>SS</td><td>10 1/4</td></tr> <tr><td>SR</td><td>10 3/4</td></tr> <tr><td>SL</td><td>11 1/4</td></tr> <tr><td>MS</td><td>10 3/4</td></tr> <tr><td>MR</td><td>11 1/4</td></tr> <tr><td>ML</td><td>11 3/4</td></tr> <tr><td>LS</td><td>11 1/4</td></tr> <tr><td>LR</td><td>11 3/4</td></tr> <tr><td>LL</td><td>12 1/4</td></tr> <tr><td>XLS</td><td>11 3/4</td></tr> <tr><td>XLR</td><td>12 1/4</td></tr> <tr><td>XLL</td><td>12 3/4</td></tr> </tbody> </table>	Size	Inch	XSS	9 3/4	XSR	10 1/4	XSL	10 3/4	SS	10 1/4	SR	10 3/4	SL	11 1/4	MS	10 3/4	MR	11 1/4	ML	11 3/4	LS	11 1/4	LR	11 3/4	LL	12 1/4	XLS	11 3/4	XLR	12 1/4	XLL	12 3/4	EA
Size	Inch																																				
XSS	9 3/4																																				
XSR	10 1/4																																				
XSL	10 3/4																																				
SS	10 1/4																																				
SR	10 3/4																																				
SL	11 1/4																																				
MS	10 3/4																																				
MR	11 1/4																																				
ML	11 3/4																																				
LS	11 1/4																																				
LR	11 3/4																																				
LL	12 1/4																																				
XLS	11 3/4																																				
XLR	12 1/4																																				
XLL	12 3/4																																				

Section III. MATERIALS

FIG. NO.	ITEM NO.	SMR CODE	NSN	DESCRIPTION	UNIT OF ISSUE																																
6-2	13	PAFZZ		Fastener, Slide, interlocking; white, type I style 3, size MS, nylon or polyester continuous coil or ladder configuration, with thong, black tape, Conforming to V-F-106, lengths corresponding to the trouser sizes indicated below: (See size code legend at the end of Section III) Slide Fastener Source: YKK (U.S A) Inc 7 Nescaminy Interplex Trevose, PA 19047 <table style="width: 100%; border-collapse: collapse;"> <thead> <tr> <th style="text-align: left;">Size</th> <th style="text-align: left;">Inch</th> </tr> </thead> <tbody> <tr><td>XSS</td><td>17 5/8</td></tr> <tr><td>XSR</td><td>20 5/8</td></tr> <tr><td>XSL</td><td>20 5/8</td></tr> <tr><td>SS</td><td>17 5/8</td></tr> <tr><td>SR</td><td>20 5/8</td></tr> <tr><td>SL</td><td>20 5/8</td></tr> <tr><td>MS</td><td>17 5/8</td></tr> <tr><td>MR</td><td>20 5/8</td></tr> <tr><td>ML</td><td>20 5/8</td></tr> <tr><td>LS</td><td>17 5/8</td></tr> <tr><td>LR</td><td>20 5/8</td></tr> <tr><td>LL</td><td>20 5/8</td></tr> <tr><td>XLS</td><td>17 5/8</td></tr> <tr><td>XLR</td><td>20 5/8</td></tr> <tr><td>XLL</td><td>20 5/8</td></tr> </tbody> </table>	Size	Inch	XSS	17 5/8	XSR	20 5/8	XSL	20 5/8	SS	17 5/8	SR	20 5/8	SL	20 5/8	MS	17 5/8	MR	20 5/8	ML	20 5/8	LS	17 5/8	LR	20 5/8	LL	20 5/8	XLS	17 5/8	XLR	20 5/8	XLL	20 5/8	EA
Size	Inch																																				
XSS	17 5/8																																				
XSR	20 5/8																																				
XSL	20 5/8																																				
SS	17 5/8																																				
SR	20 5/8																																				
SL	20 5/8																																				
MS	17 5/8																																				
MR	20 5/8																																				
ML	20 5/8																																				
LS	17 5/8																																				
LR	20 5/8																																				
LL	20 5/8																																				
XLS	17 5/8																																				
XLR	20 5/8																																				
XLL	20 5/8																																				
			5325-01-360-7910																																		
			5325-01-360-6172																																		
			5325-01-360-6172																																		
			5325-01-360-7910																																		
			5325-01-360-6172																																		
			5325-01-360-6172																																		
			5325-01-360-7910																																		
			5325-01-360-6172																																		
			5325-01-360-6172																																		
			5325-01-360-7910																																		
			5325-01-360-6172																																		
			5325-01-360-6172																																		
			5325-01-360-7910																																		
			5325-01-360-6172																																		
			5325-01-360-6172																																		

GARMENT SIZE CODE LEGEND:

- XSSX-SMALL SHORT
- XSR.....X-SMALL REGULAR
- XSL.....X-SMALL LONG
- SSSMALL SHORT
- SRSMALL REGULAR
- SL.....SMALL LONG
- MSMEDIUM SHORT
- MR.....MEDIUM REGULAR
- MLMEDIUM LONG
- LSLARGE SHORT
- LR.....LARGE REGULAR
- LLLARGE LONG
- XLS.....X-LARGE SHORT
- XLRX-LARGE REGULAR
- XLLX-LARGE LONG

CHAPTER 7

MAINTENANCE OF MEN'S AND WOMEN'S FOOD HANDLER'S GARMENTS

Section I. INTRODUCTION

7-1. SCOPE

This chapter provides instructions that cover the materials, methods, and procedures for the repair and maintenance of the food handler's garments

7-2. COMMODITY SPECIFICATIONS

a. Items.

ITEM	SPECIFICATION
Apron, Food Handler's	FED-DDD-A-616
Coat, Food Handler's	FED-BBB-C-521
Trousers, Food Handler's	FED-BBB-T-651
Smock, Man's, Food Inspector and Meat Handler	MIL-S-1820
Dress, Food Handler's, Woman	MIL-D-3018
Smock, General Purpose	MIL-S-2124

b. Components.

ITEM	SPECIFICATION
Buttons, Sewing Hole, and Button, Staple, Plastic	V-B-871
Fastener, Slide, Interlocking	V-F-106
Thread, Cotton	V-T-276
Thread, Cotton, Hole, Gimp	V-T-280
Cloth, Drill, Cotton	CCC-C-426
Cloth, Sheeting, Cotton	CCC-C-432
Cloth, Uniform Twill, Cotton	CCC-C-461
Fasteners, Snap	MIL-F-10884

7-2. TECHNICAL PUBLICATIONS

NUMBER	TITLE
FM 10-280	Field Laundry, Bath and Clothing Exchange Operations.

7-4. DESCRIPTION AND IDENTIFICATION

- a. Apron, Food Handler's, cotton drill, white; conforming to FED. DDD-A-616, Type I: NSN 8415-00-255-8577. This item is fabricated of 6.5 ounce white cotton drill It is a bib type apron with neck loop and tie strings at waist for fastening. The apron is 46 inches (116.84 cm) long by 36 inches (91.44 cm) wide (see figure 7-1).
- b. Coat, Food Handler's, Cotton drill, white; short sleeves, bakers and cooks, conforming to FED. BBB-C-521; NSN 8415-00-543-6883, 8415-00-185-0515 thru 0518. This item is fabricated of 6 5 ounce white cotton drill. It is a four snap, single breasted model, collar with separate stand notched lapels, left breast pocket, and two-piece back (fig. 7-2).

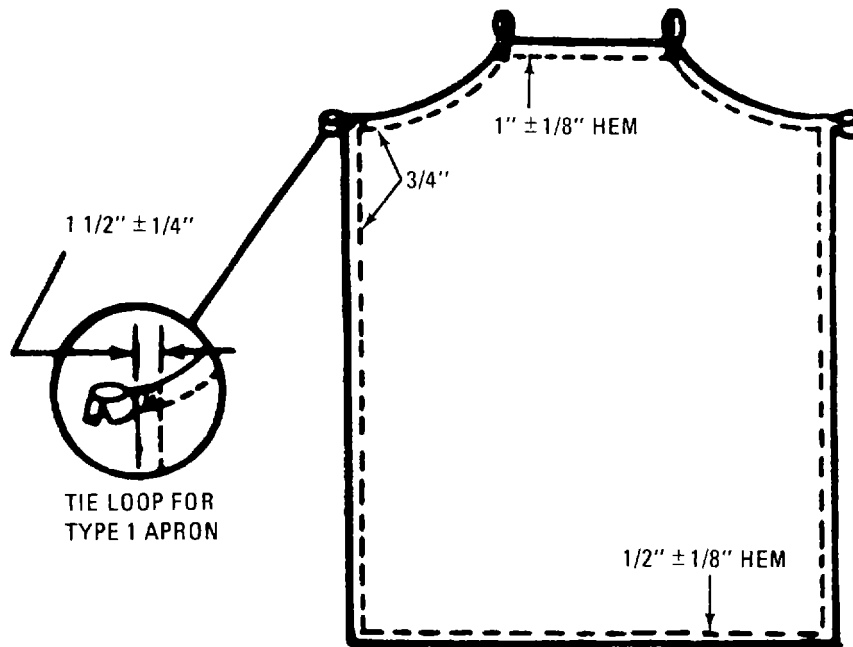

Figure 7-1. Apron, Food handlers, type 1.

7-4. DESCRIPTION AND IDENTIFICATION-Continued

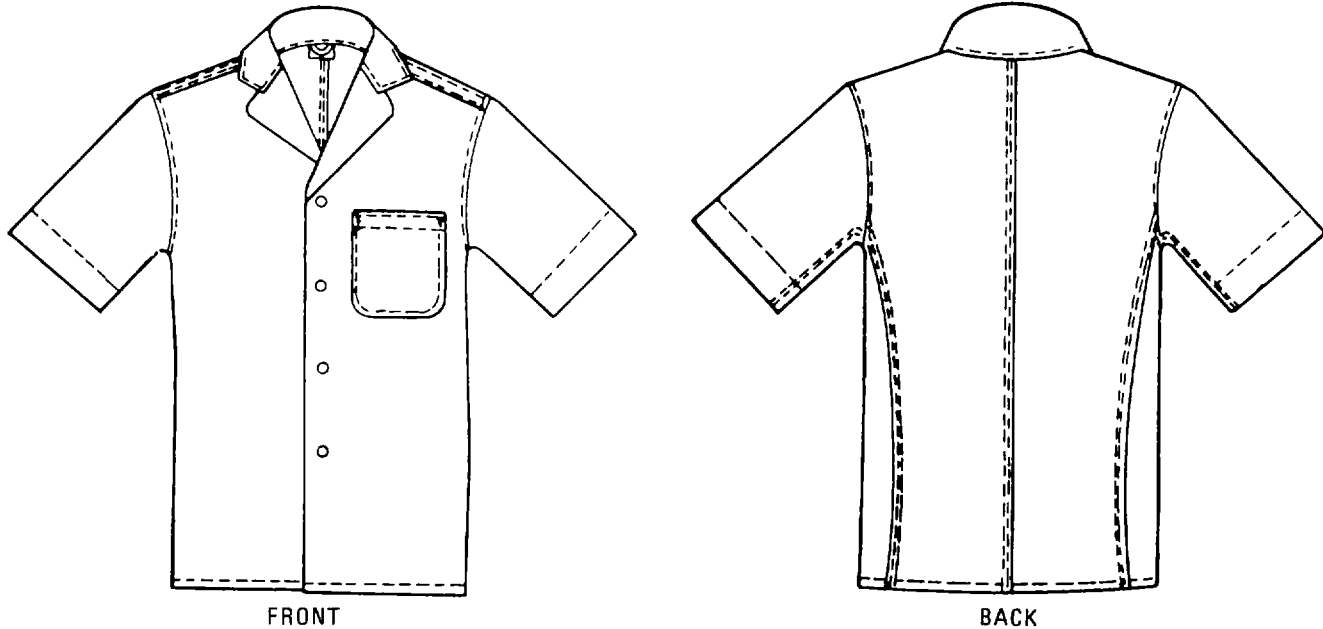

Figure 7-2. Coat, food handlers, cotton drill, white, type 1.

- c. Trousers, Food Handlers, cotton drill, white, bakers and cooks, conforming to FED. BBB-T-651; NSN 8415-00-163-7701 through 8415-00-163-7704, 8415-00-163-9553 and 8415-00-163-1637. This item is fabricated of 6.5 ounce white cotton drill cloth. It has two side pockets, one hip patch pocket, belt loops, waist adjustment tabs and slide fastener fly (see figure 7-3)
- d. Dress, Food Handlers, cotton, white; food handler's, conforming to MIL-D-3018; NSN 8415-00162-4219, 8415-00-1624244 through 8410-00-162-4251 and 8415-00-162-1621. This item is fabricated of 4.7 ounce white cotton sheeting cloth. It is a one-piece wrap around with attached waistband belt, convertible collar, short sleeves, back waist patch pockets on left waist and right skirt fronts, reinforcement at underarm and button down shoulder loops (fig. 7-4)
- e. Smock General Purpose, cotton, drill, white; long sleeve, conforming to MIL-S-2124, NSN 841500-823-7611 through 8415-00-823-7614. This item is fabricated of 6.5 ounce white cotton drill cloth. It is a four button, single breasted model, collar with separate stands, notch lapel, four patch pockets, two-piece back and center vent (fig. 7-5).
- f. Smock, Food Inspector's, cotton twill, white; long sleeve, conforming to MIL-S-1820, NSN 841500-782-9498 through 8415-00-782-9501. This item is fabricated of 7.5 ounce white cotton uniform twill cloth. It is a four snap, single breasted model, long sleeve, four patch pockets, two-piece belted back, and center vents (fig. 7-6)

155-768 O-94-5

7-4. DESCRIPTION AND IDENTIFICATION-Continued

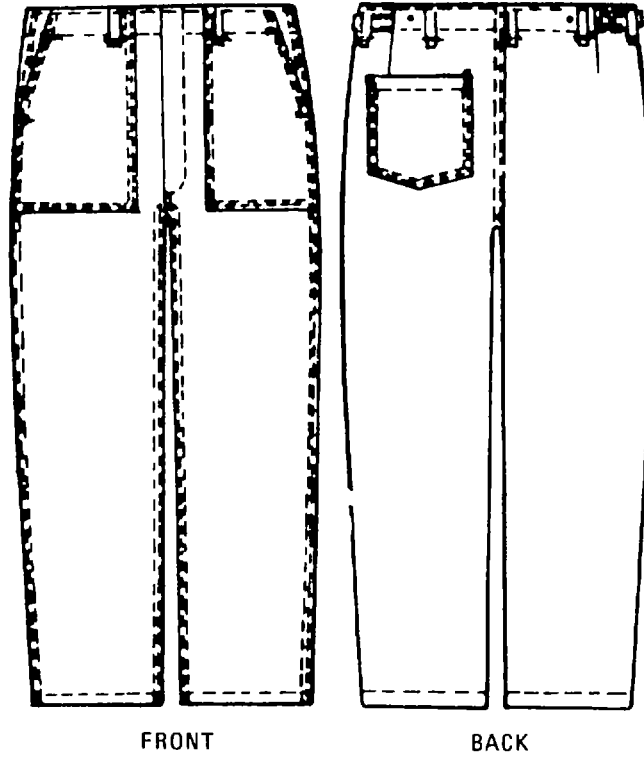

Figure 7-3. Trousers, food handlers, cotton drill, white (class 2).

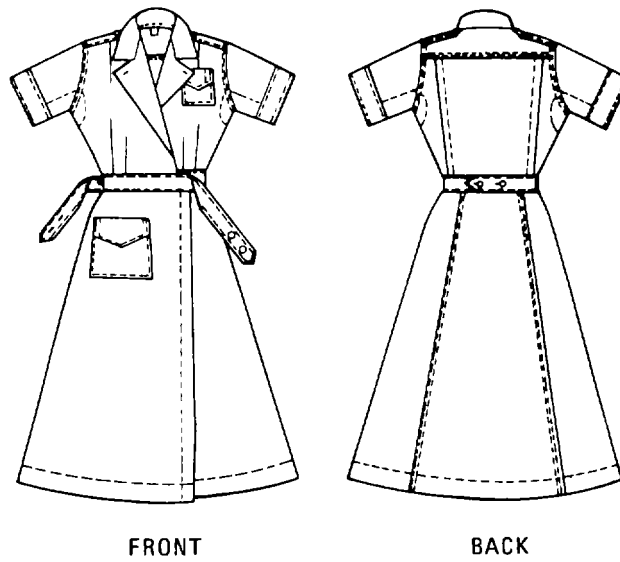

Figure 74. Dress, food handlers, woman's.

7-4. DESCRIPTION AND IDENTIFICATION-Continued

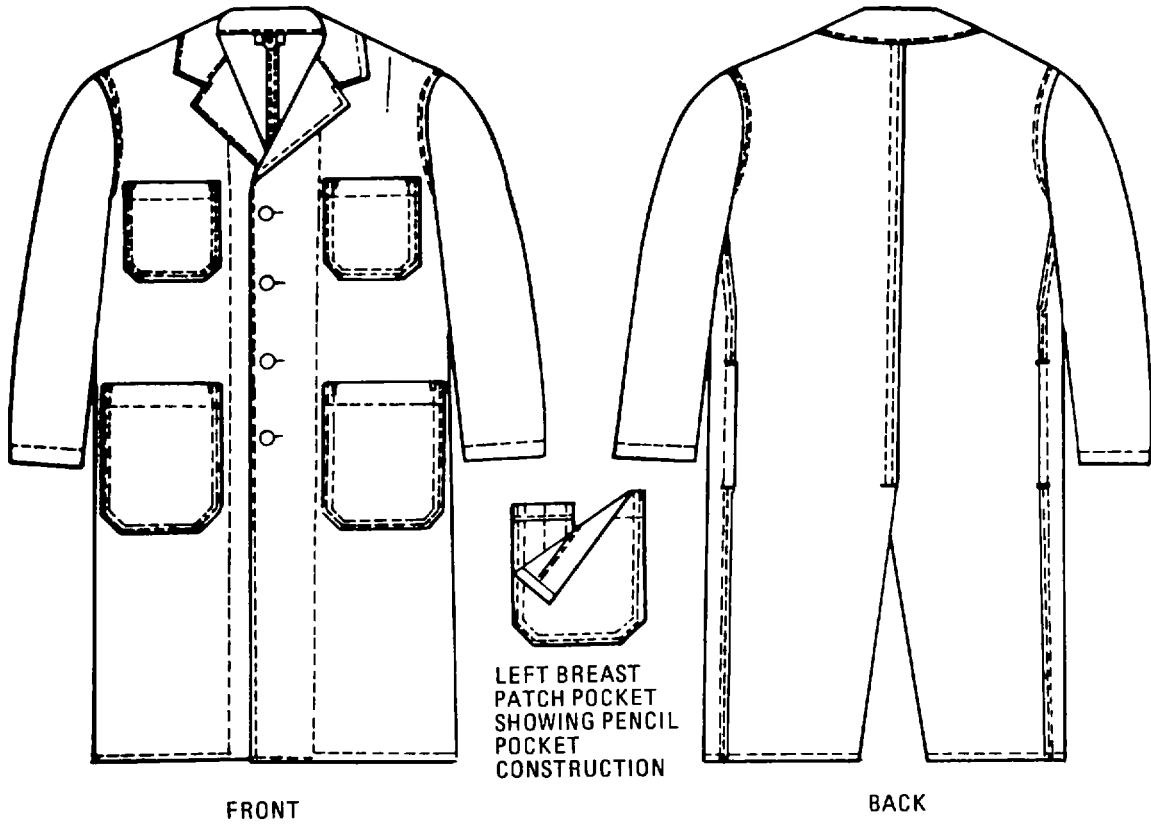

Figure 7-5. Smock General Purpose

7-4. DESCRIPTION AND IDENTIFICATION-Continued

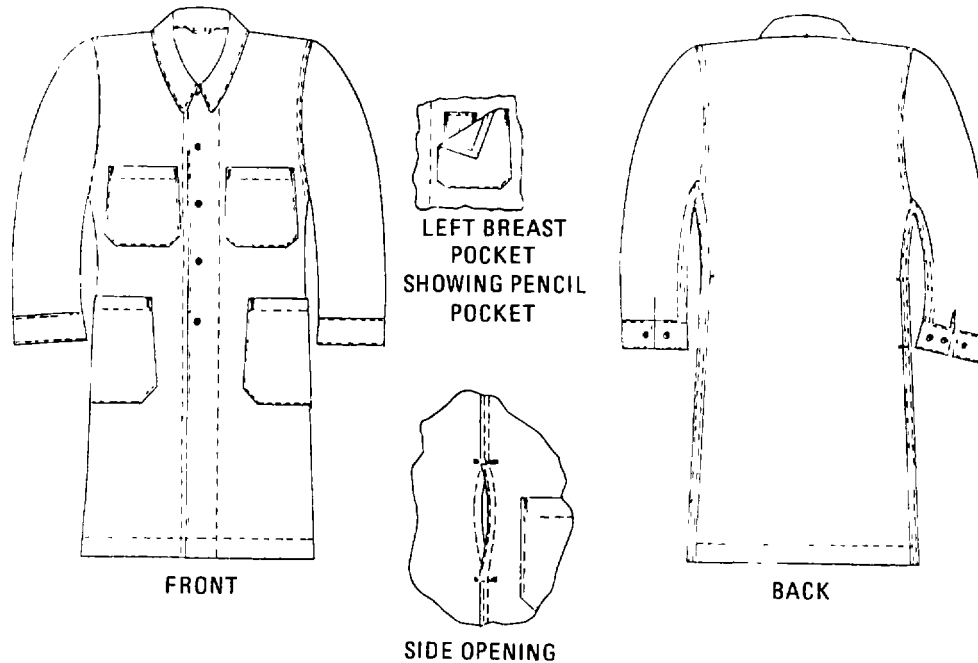

Figure 7-6. Smock Food Inspector's

Section II. REPAIR PROCEDURES

7-5. MATERIALS

Materials used in the repair of the food handling garments shall be serviceable materials received from similar salvaged items, when authorized, or will be new materials as specified in section 111. New materials will be requisitioned from stock under the stock numbers and/or item descriptions and shall conform to the appropriate specifications. When not available from stock, the materials may be purchased locally which conform as closely as possible to the standard material.

7-6. CLASSIFICATION

Refer to chapter 1 for serviceability classification for food handler's clothing.

7-7. REPAIR AND MAINTENANCE

Prior to repair each item will be inspected to determine necessary repairs. Items will be repaired to a serviceable condition consistent with the requirements of condition code "B". The following will be observed as fully as skills, facilities, funds, and local conditions permit. The sequence of operations may be determined by the repairing organization unless otherwise prescribed.

a. Organizational Maintenance.

- (1) Inspection. Inspect items to determine repairs needed and whether such repairs can be accomplished within the organization.
- (2) Repairs. The following minor repairs may be accomplished by hand sewing.
 - (a) Replace missing or damaged buttons.
 - (b) Resew rips, tears and loose seams.
 - (c) Resew torn-out buttonholes and reattach loose belt loops.
 - (d) Resew loose waist tie straps and neck loops.
 - (e) Patching. Garments may be patched using iron-on patches
 - 1 Iron-on patches. Rips and tears, at other than stress points (e g., crotch seams, pocket seams, pocket flap seams, etc.), may be repaired by iron-on patches. Any rip or tear closer than 3/4 Inch (1.76 cm) to any seam will be repaired by sewing
 2. Patch size. Commercial pre-cut iron-on patches shall be selected for the desired size and shape such that, when applied, it will extend approximately 3/4 inch (1.76 cm) in all directions beyond the tear or other damage. Patches will have rounded corners. Pre-cut patches in several sizes may be used.
 3. Patching procedure for Iron-on patches. When patching by hand-iron, place the garment area to be patched on an ironing board. Where possible, patches shall be applied to the inside of the garment. The garment may be turned inside out or the patch may be inserted within the garment, taking care that the patch is centered in the desired position. Trim heavily raveled ends with scissors (fig. 7-7)

7-7. REPAIR AND MAINTENANCE

Figure 7-7. Preparing a tear for patching

- (3) Quality control. Adjust heating, pressing, and cooling times as required for the specific iron being used. Check the quality of the adhesive bond periodically and adjust heating times and temperatures of the iron as follows.

7-7. REPAIR AND MAINTENANCE-Continued
--

- (a) Periodically during the work and when adjusting the Iron, test a patch which has cooled for about 5 minutes by picking with the fingers at an edge of the patch until a tab about 1/4 to 1/2-inch (0.64 cm to 1.76 cm) long is formed. Pull hard on the tab with fingers. A well bonded tab will be difficult to peel off and will indicate that Iron adjustment and heating time are adequate. Replace the check test patch with a new patch.
 - (b) If the adhesive strikes through the patch cloth, too much heat has been applied. Reduce time of pressing or temperature of the Iron. A small amount of strike through is not objectionable provided the patch meets the above cited check test.
 - (c) A bonded patch which has a lifted edge will be re-ironed. A bonded patch which has been subjected to the check test will be replaced.
 - (d) When patching by special automatic press, the platen temperature, dwell time, dwell pressure, and other details shall be in accordance with the press manufacturer's Instructions.
- (3) Cleaning. Clean items by utilizing laundry facilities provided at the installation. If cleaned by user laundry items in water as hot as the hands can stand using a mild soap or detergent.
- b. Direct Support Maintenance.
- (1) Preliminary examination and cleaning. Remove dirt, mud, dust and other foreign matter by brushing. Test item for weakness by placing thumb on the area in question and applying pressure, or by pinching the cloth and attempting to tear against the warp. Test seams by grasping the item with both hands and pulling at right angles to the seam. Mark places to be repaired with crayon. Erase or obliterate non-specifications and personnel markings.
 - (2) Laundering. Items will be processed in Army laundry facilities in accordance with established practices set forth in FM 10-280. When such facilities are not available, items will be laundered by contract with private industry in accordance with acceptable commercial laundry practices.
 - (3) Repair.
 - (a) Stitching. The following types of stitch (illustrated in Specification Fed-S-751), thread size, and stitches per inch will be used when stitching is permitted in subsequent paragraphs (table 7-1).
 - (b) Buttons. Resew loose buttons. Replace defective, broken or missing buttons with new ones of like size, color and style. Turn in the ends of braid or coat buttons and double bartack.
 - (c) Buttonholes. Rework defective buttonholes over gimp for proper fit over buttons, securely bartack the ends. Reshape enlarged buttonholes before reworking.
 - (d) Belt Loops. Restitch loose belt loops. Replace frayed, torn or worn loops by fabricating from like material to same size as item being replaced.
 - (e) Coat hanger loops. Restitch loose hanger loops. Replace missing or defective loops with new ones fabricated from like material to same size as that being replaced.

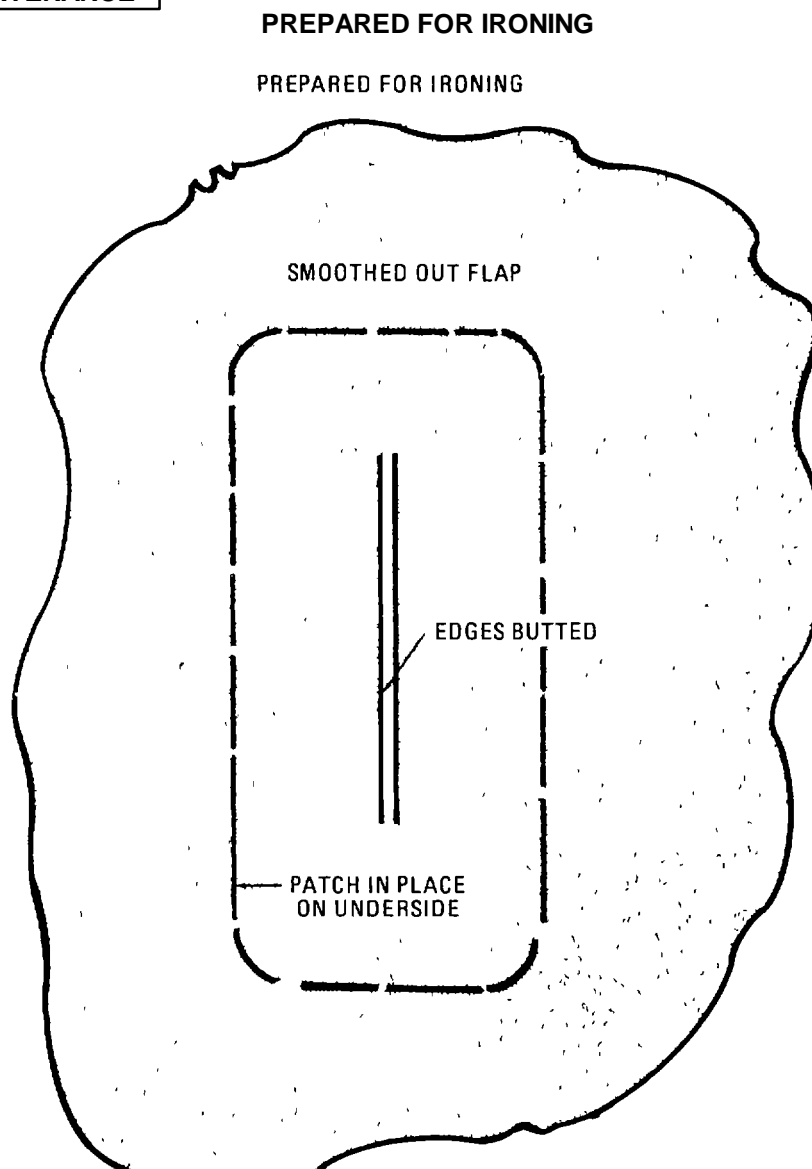
7-7. REPAIR AND MAINTENANCE-Continued

- (4) Resizing. Resize all items after repair and cleaning according to schedules listed in tables 71-2 through 7-6. When item's deviate in size from original marking, obliterate the old marking, and print or stamp the proper size with an indelible pencil or waterproof Ink near the old size. When an item measures smaller than the size listed, mark the next lower size in the garment. Items with measurements falling below the lowest size in the schedule will not be accepted as condition code "B".
- (a) Food handler's apron. The Army uses the one-piece bib apron with tie loops and separate tie and neck tapes Size 1 is 46 inches (116.84cm) long.
 - (b) Food handler's white cotton drill coat. The coat when measured, shall be closed (snapped) and laid out without tension on a smooth, flat surface so that creases and wrinkles will not affect the measurement. Smooth out the area to be patched so that the tear is closed or very nearly closed, and so that there will be no wrinkles, folded seams, or other protrusions under the iron when it is applied. Pre-warm the area to be patched by pressing with a household electric dry Iron, or steam iron used dry. With the iron set at the cotton Indicator or as high as possible without scorching the fabric, apply the iron for 5 seconds or more. Immediately position the patch of the desired size and shape. Hold the iron on the patch for about 12 seconds. Use no more than a slight rotating or reciprocal motion of the iron and apply constant pressure. Remove the iron and allow the patched area to cool in place for about 5 seconds or long enough so that the patch will not life off when the garment is removed from the ironing board. Patches that are longer than the iron may be ironed in sections, starting at the center and completing each section before proceeding to the next section. Overlapping of the Iron upon a previously bonded section is permissible. Carefully trim away any frayed protrusions at the torn edges.

Table 7-1. *Stitching Instructions*

LOCATION	STITCH TYPE	THREAD		STITCHES PER INCH
		NEEDLE	BOBBIN	
GENERAL	301	50/3	50/3	10-14
BARTACK	50/3	50/3	28
BUTTONHOLE (FLY)	50/3	50/3	46
BUTTONHOLE OVEREDGE	50/3	50/3	52
OVEREDGE	504 or 505	50/3	*50/3	8-10
OVEREDGE	503 or 504	*50/3	*50/3	10
BUTTONS	301	20/4	20/4	16
BUTTONS	301	50/3	50/3	15

*May use 70/2 thread.

7-7. REPAIR AND MAINTENANCE-Continued

- (c) Darning and patching. Darn small holes, tears, or frays less than 7/8 inch (2.22cm) in diameter. Place a small reinforcement piece of cloth of like material on underside of the garment, then zigzag stitch through both the garment and patch. Closely trim the reinforcement. Patch holes over 7/8 inch (2.22cm) in diameter, using symmetrical shaped patches of like material. Turn in the raw edge of the patch and single stitch. Trim frayed edges and rehem the bottom edge of the garments with the raw edges of the hem turned in. Trimming and rehemming of aprons will not be done if this repair reduces the length of the apron more than 1 inch (2.54cm). Confine the repair of neck loop and waist strap to restitching; replace defective loops and straps. Replace badly defective bibs and skirt sections with like material.

Table 7-2. Resizing Instructions

(Finished measurement in inches)

FOOD HANDLER'S COAT

SIZE	30	34	38	42	46	TOLERANCE*
* CHEST	36	40	44	48	52	1
** SLEEVE LENGTH	43/4	43/4	43/4	43/4	43/4	1/4
*** BACK LENGTH	28 3/4	29 3/4	31 3/4	31 3/4	32 1/4	1/2

- * Chest. Twice the measurement across the coat at the base of armhole
- ** Sleeve length. Along inseam of sleeve from base of armhole to the end of sleeve
- *** Back length. Measured from the center point where the body of the coat joins the collar of the coat

Table 7-3. Resizing Instructions

(Finished measurement in inches)

FOOD HANDLER'S TROUSERS

LOCATION	26	30	34	38	42	46	Tolerance +
	X-SMALL	SMALL	MEDIUM	LARGE	X-LARGE	XX-LARGE	
* 1/2 WAIST	13	15	17	19	21	23	1/2
** INSEAM	33	33	33	33	33	33	1/2
*** 1/2 SEAT	19	21	23	25	27	28	3/4

- Method of Measuring. Lay out garment on a flat surface so that wrinkles will not affect the measurement
- 1/2 Waist. The waist will be measured between outside edges of waistband when the garment is buttoned
 - ** Inseams. The inseams shall be measured along the inside seam from the crotch to the bottom of the leg
 - *** 1/2 Seat. The seat shall be measured across the garment at the fullest part between the crotch and the waistband

7-7. REPAIR AND MAINTENANCE-Continued

Table 7-4. Resizing Instructions

(Finished measurement in inches)

WOMEN'S FOOD HANDLER'S DRESS

LOCATION	10	12	14	16	18	20	22	24	26	Tolerance +
* CROSS BACK WIDTH	14 5/8	15 1/8	15 5/8	16 1/4	16 7/8	17 1/2	18	18 1/2	19	3/8
** BACK LENGTH	46	46 1/2	47	47 1/2	48	48 1/2	49	49	49	3/4
*** SWEEP	75	77	79	81	83	85	87	92	94	2

Method of Measuring. The dress shall be buttoned, placed smooth and flat upon a table and measured as follows

- * Cross back width. From armhole seam to armhole seam along bottom edge of yoke
- ** Back length. From collar seam down back to bottom edge of dress
- *** Sweep. From front edge along bottom of hem to opposite front edge.

Table 7-5 Resizing Instructions

(Finished measurement in inches)

GENERAL PURPOSE SMOCK

LOCATION	SIZE				TOLERANCE +
	SMALL	MEDIUM	LARGE	X-LARGE	
* CHEST	22	24	26	28	1
** SLEEVE SEAM	18	18	18	18	1/2
*** BACK LENGTH	42 1/2	43 1/4	43 3/4	44 1/2	1

- * Chest. With the smock buttoned, measure across chest, at base of armhole, from folded edge to folded edge
- ** Sleeve seam. Measure sleeve seam from sleeve setting seam to end of sleeve. If sleeve is set with double-tapped seam, measure seam from the center of sleeve setting seam to the bottom of sleeve
- *** Back length. Measure back length down center from collar joining seam to a point in line with bottom of smock

7-7. REPAIR AND MAINTENANCE - Continued*Table 76. Resizing Instructions*

(Finished measurement in inches)

FOOD INSPECTOR'S SMOCK

LOCATION	SMALL	MEDIUM	LARGE	X-LARGE	TOLERANCE i
* 1/2 BREAST	27 7/8	27 7/8	29 7/8	31 7/8	1/2
** SLEEVE INSEAM	17 1/2	17 1/2	17 1/2	17 1/2	1/2
*** LENGTH	49	50 1/2	52	53 1/2	1

* 1/2 Breast. Measurement taken from side seam at the base of the armholes with the front snapped.

** Sleeve Inseam. Sleeve length measurement taken along the underarm seam of sleeve from base of armhole to bottom edge of cuff.

*** Length. Length is taken along the center back seam of smock from collar joining seam to the bottom edge of smock.

7-8. WORKMANSHIP

All work will be accomplished by personnel skilled in the particular trade applicable to their duties in the repair of subject items. Darning shall be neatly accomplished and patches shall be of the proper size and firmly stitched to the garments. Stitching and reseaming shall be secure, and loose ends shall be turned and loose thread trimmed. Buttons, buckles and belt loops shall be securely and properly attached to function as intended. The finished Item shall be completely and well repaired, thoroughly cleaned, and free from all defects which may affect serviceability or general appearance.

7-9. INSPECTION

The inspection or quality control unit is responsible for determining compliance with repair instructions and requirement for classification. In process inspections will be performed for quality of workmanship and correct application of repair procedures. The complete item will be inspected for serviceable appearance and condition, to insure against return of a substandard product to supply channels.

Section III. MATERIALS

(1) SMR CODE	(2) NATIONAL STOCK NUMBER	(3) DESCRIPTION	(4) UNIT OF ISSUE
XBFZZ		Fasteners, Slide, Interlocking; Type I, Style 3, Size L Slides, V-F-106. Local Purchase.	EA
PAFZZ	8305-00-227-6131	Cloth, Cotton, Drill Cloth, White, Type II, Class 3, CCC-C-426.	YD
XBFZZ		Cloth, Bleached Cotton, Sheeting; Type VII, Class 3, CCC-C-432. Cannibalize From Unrepairable Items.	YD
XBFZZ		Cloth, Twill; Cotton, Type VI, CCC-C-461. Cannibalize From Unrepairable Items.	
PAFZZ	5325-00-292-5343	Fasteners, Snap, Brass; Style A, Finish 2, MIL-F-10884.	HD
PAOZZ	8315-00-163-1527	Buttons; Sewing Hole, Type II, Class D, Style 19, 24 Line, V-B-871, C.A. 62031	GR
PAOZZ	8315-00-773-4520	Buttons, Staple, Conform, to Type III, Class A, 30 Line, Style 1, White Shade BA of V-B-871.	GR
PAFZZ	8310-00-262-0099	Thread Gimp, Cotton, no. 8, White, C.A. 66050 Type II, V-T-280.	SL

CHAPTER 8

MAINTENANCE OF THE COLD WEATHER CAP, HOT WEATHER CAP, BATTLE DRESS CAP, DESERT HAT, CAMOUFLAGE HAT AND INSECT NET, AND EXTREME COLD WEATHER HOOD.

Section I. INTRODUCTION

8-1. SCOPE

This chapter provides Instructions covering the materials, methods, and procedures for the repair and maintenance of hoods, hats, and caps.

8-2. COMMODITY SPECIFICATIONS

a. Items.

SPECIFICATION	ITEM
MIL-H-43555	Hood, Winter W/Fur Ruff, OG 107
M IL-C-43724	Cap, Hot Weather, OG 507
MIL-H-43577	Hat, Insect Net; Hat, Camouflage
Pattern.	
MIL-C-1911	Cap, Camouflage Pattern.
Cap, Insulating, Helmet Liner.	
M IL-C-43549	Hat, Camouflage Pattern Desert.
MIL-H-44105	

b. Components.

SPECIFICATION	ITEM
V-L-61	Laces, Nylon
V-B-871	Button, Sewing Hole & Button, Staple
V-T-276	Thread, Cotton
V-T-280	Thread, Cotton Gimp, Buttonhole
V-T-285	Thread, Polyester
V-T-295	Thread, Nylon

8-2 COMMODITY SPECIFICATION-Continued

SPECIFICATION	ITEM
M I L-C-342 MIL-B-371 M I L-C-508 M I L-C-43352 M I L-T-3530 Repellent Treated MIL-C-3924 Filling, Quarpel Treated M I L-C-93791 Press) KK-L-271 MIL-C-3760 and Nylon M I L-T-43548 M I L-C-44034 and Nylon and Daytime Desert Uniforms M I L-C-43468 Poplin, Cotton	Cloth, Wind Resistant, Twill & Poplin, Cotton Braid, Textile (Cotton, Tubular) Cloth, Nylon, Oxford, 3 ounce Cloth, Netting, Nylon, Tulle Tricot Thread and Twine, Mildew Resistant or Water Cloth, Oxford, Cotton Warp and Nylon Cloth, Twill, Polyester/Cotton (Durable Leather, Cattlehide, Strap, Vegetable-Tanned Cloth, Flannel, Wool and Cotton, and Wool Thread, Polyester, Cotton-Covered Cloth, Twill, Camouflage Pattern, Cotton Cloth, Camouflage Pattern, Wind Resistant

8-3. TECHNICAL PUBLICATIONS

NUMBER	TITLE
FM 10-280	Field Laundry, Bath and Clothing Exchange Operations

8-4. INDENTIFICATION AND DESCRIPTION

- a. Hood, Extreme Cold Weather, with fur ruff, olive green shade 107, M-65, MIL-H-43555 NSN 8415-00-782-3004. This item is fabricated essentially of cotton warp and nylon filled oxford cloth, 5.3 ox., olive green shade 107, with fur ruff and is designed for wear in extremely cold climates It is an adjustable head covering which is worn over any combination of headgear The hood is issued in only one size and should be adjusted to fit (see figure 8-1)

8-4. IDENTIFICATION AND DESCRIPTION-Continued

- b. Cap, Cold Weather. Cotton and nylon oxford cloth, quarpel treated, acrylic cloth and nylon, fleece lined, MIL-C-34549. NSN 8415-00-782-2916 through 8415-00-782-2921 for the OG 107 cap and NSN 8415-01-099-7843 through 8415-01-099-7848 for the woodland camouflage pattern. This item is fabricated essentially of cotton warp and nylon filled oxford cloth, olive green shade 107 or woodland camouflage pattern. The earflaps are lined with knitted nylon fleece cloth and the crown is lined with acrylic cloth (fig 8-2).
- c. Cap, Hot Weather, Polyester/Cotton, Olive Green 507, MIL-C-43724. NSN 8415-01-072-8716 through NSN 8415-01-072-8728. This cap is fabricated essentially of polyester/cotton twill cloth, 7.3 oz., olive green shade 507. It is intended for wear as a component of the hot weather field uniform and the utility uniform (fig. 8-3).
- d. Hat and Insect Net, Camouflage Pattern. Cotton rip-stop poplin cloth, quarpel treated, olive green shade 107, MIL-H-43577, NSN 8415-00-141-0819 through 8415-00-141-0831.
- (1) This hat is made of lightweight water repellent cotton, has a low slope crown with semi-rigid interlined brim, an adjustable chin strap, screened eyelets on each side of crown and a head band with slots for insertion of camouflage material (fig. 8-4)
 - (2) The detachable camouflage headnet is made of nylon netting materiel, extremely light-weight, weighing only a few ounces.
 - (3) A standard camouflage style jungle hat which is comparable in design but which is made from basic fabric with camouflage pattern. The brim of the camouflage hat is 3 inches (7.62 cm) in lieu of 2-1/2 inches (6.35 cm) wide for the standard hat brim
- e. Cap, Camouflage Pattern. Cotton and nylon oxford cloth, quarpel treated, woodland camouflage pattern, MIL-C-1911, NSN 8415-01-134-3175 through 8415-01-084-1688. This cap is fabricated essentially of cotton warp and nylon filled oxford cloth, 5 3 oz, woodland camouflage pattern with visor. The earflaps are lined with wool and nylon flannel. It is intended for wear with the temperate battledress uniform (fig. 8-5).
- f. Hat, Desert Camouflage Pattern. Cotton and Nylon twill cloth, camouflage printed, MIL-H-44105, NSN 8415-01-102-6776 through 8415-01-102-6788. This hat is made from cotton and nylon twill cloth, has a low slope crown with a semirigid interlined brim, and adjustable chin strap and screened eyelets on each side of crown (fig 8-6).
- g. Hat, Sun, Hot Weather, Woodland Camouflage (fig. 8-4). Cotton, wind-resistant rip-stop poplin cloth conforming to type IV of MIL-C-43468, NSN 8415-01-196-8368 through 8415-01-196-8374. The Hot Weather Sun Hat is very similar in design to the hat used in the Hat and Insect Net (subparagraph d above). The camouflage pattern is different.

8-4. IDENTIFICATION AND DESCRIPTION-Continued

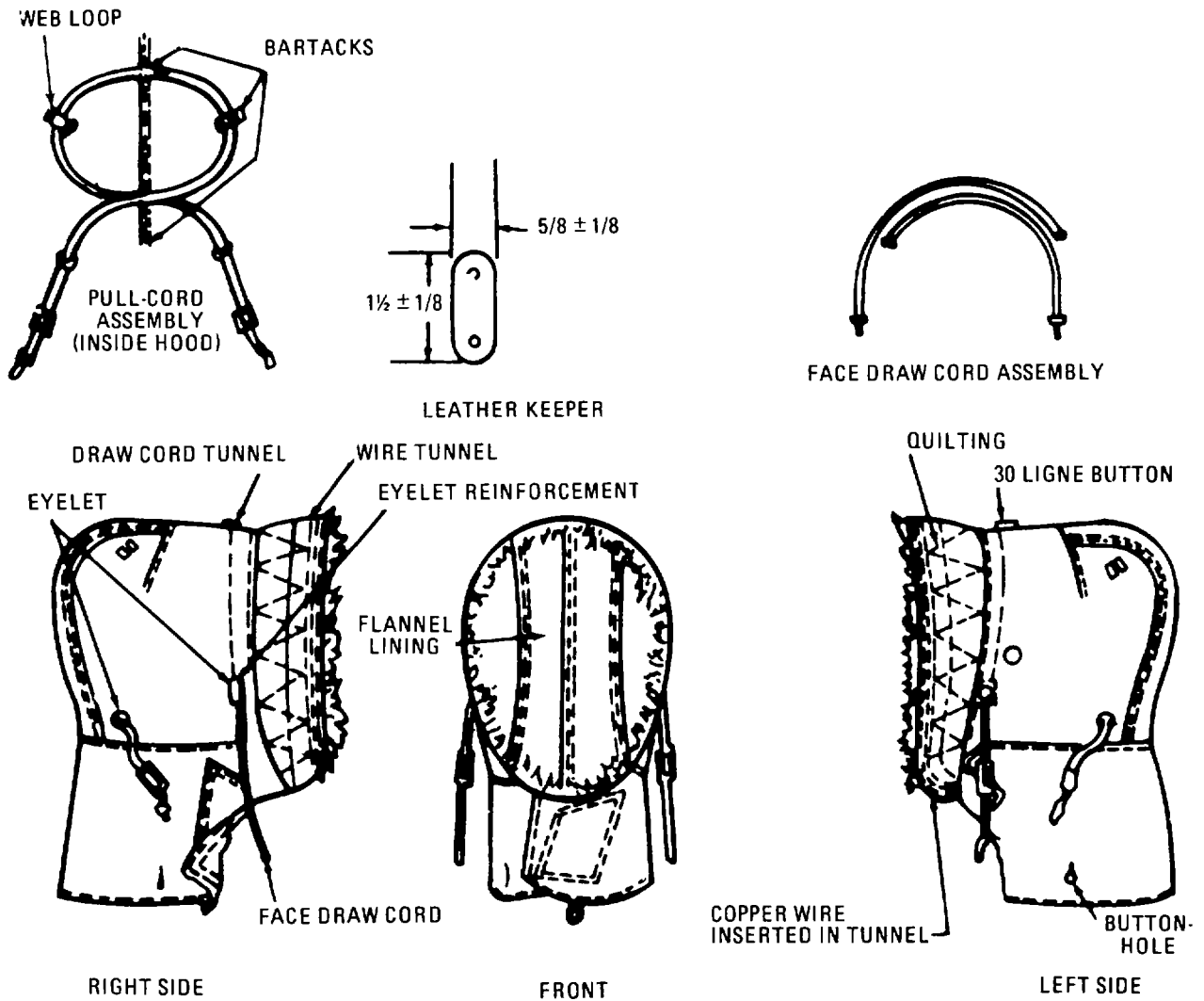

Figure 8-1. Hood, extreme cold weather, w/fur ruff, OG 107, M-65.

8-4. IDENTIFICATION AND DESCRIPTION-Continued

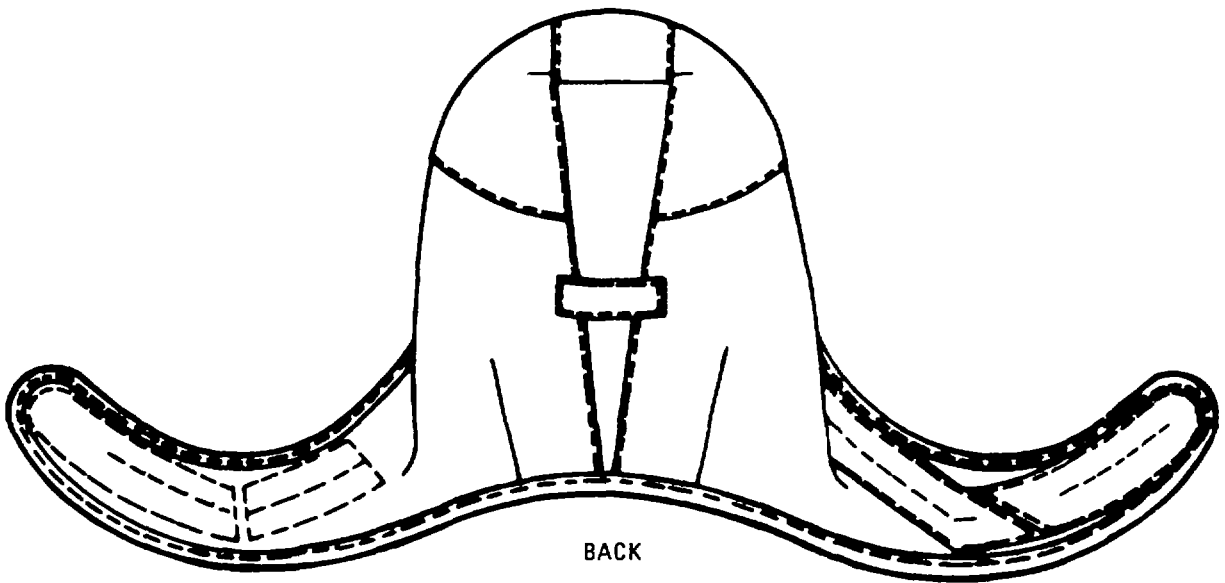
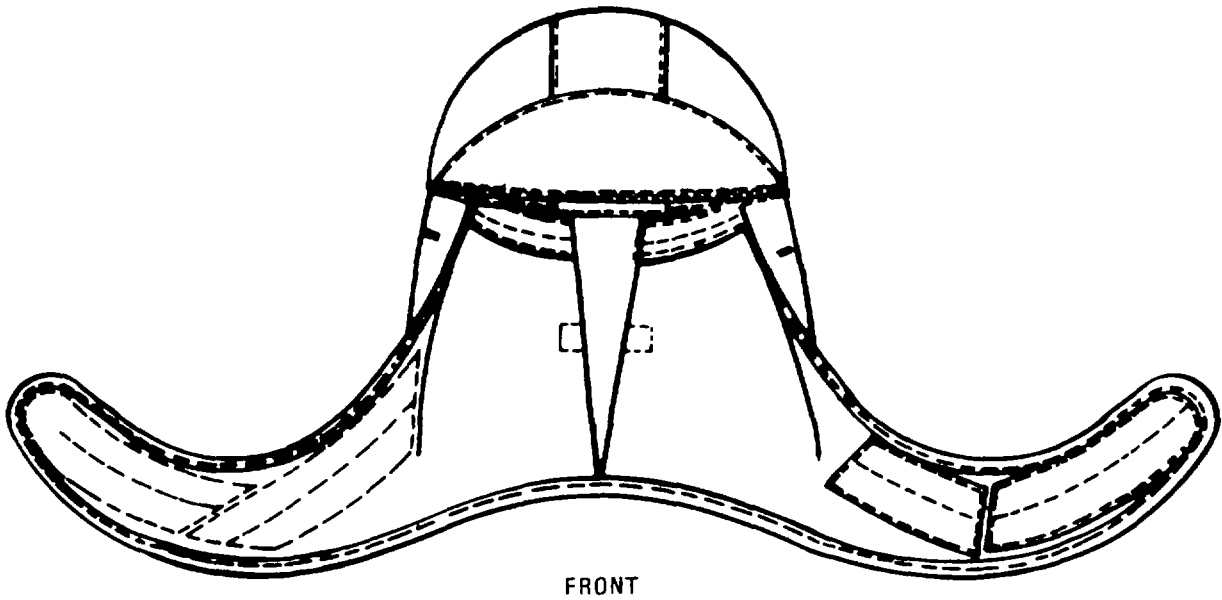

Figure 8-2. Cap, Cold Weather

8-4. IDENTIFICATION AND DESCRIPTION-Continued

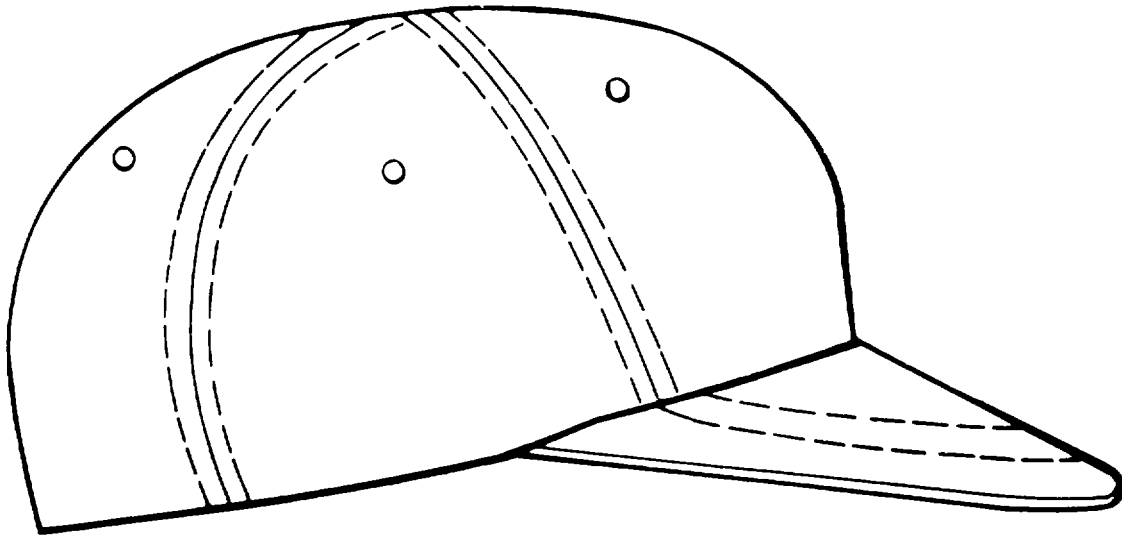

Figure 8-3. Cap, Hot Weather

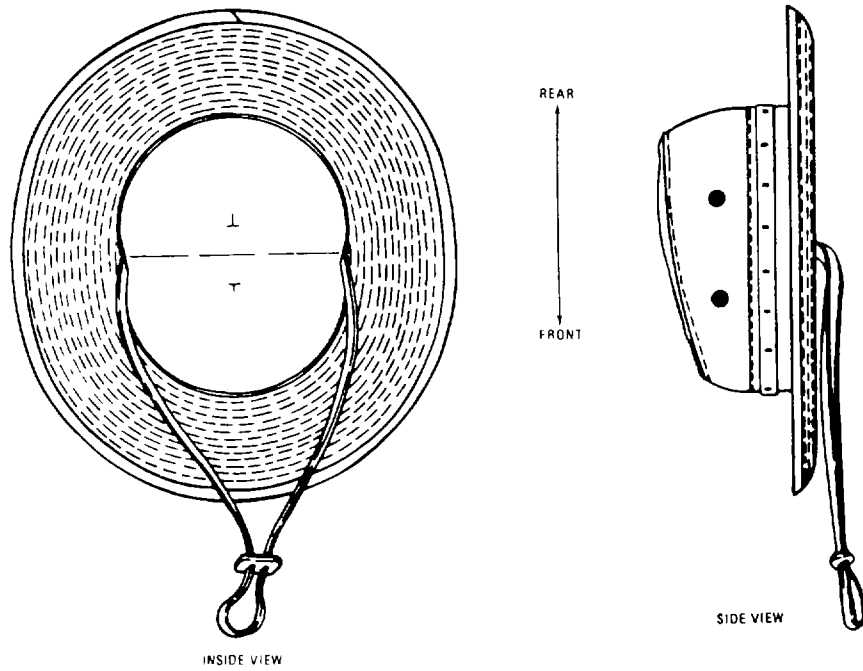

Figure 8-4. Hat and Insect Net/Hot Weather Sun Hat

8-4. IDENTIFICATION AND DESCRIPTION-Continued

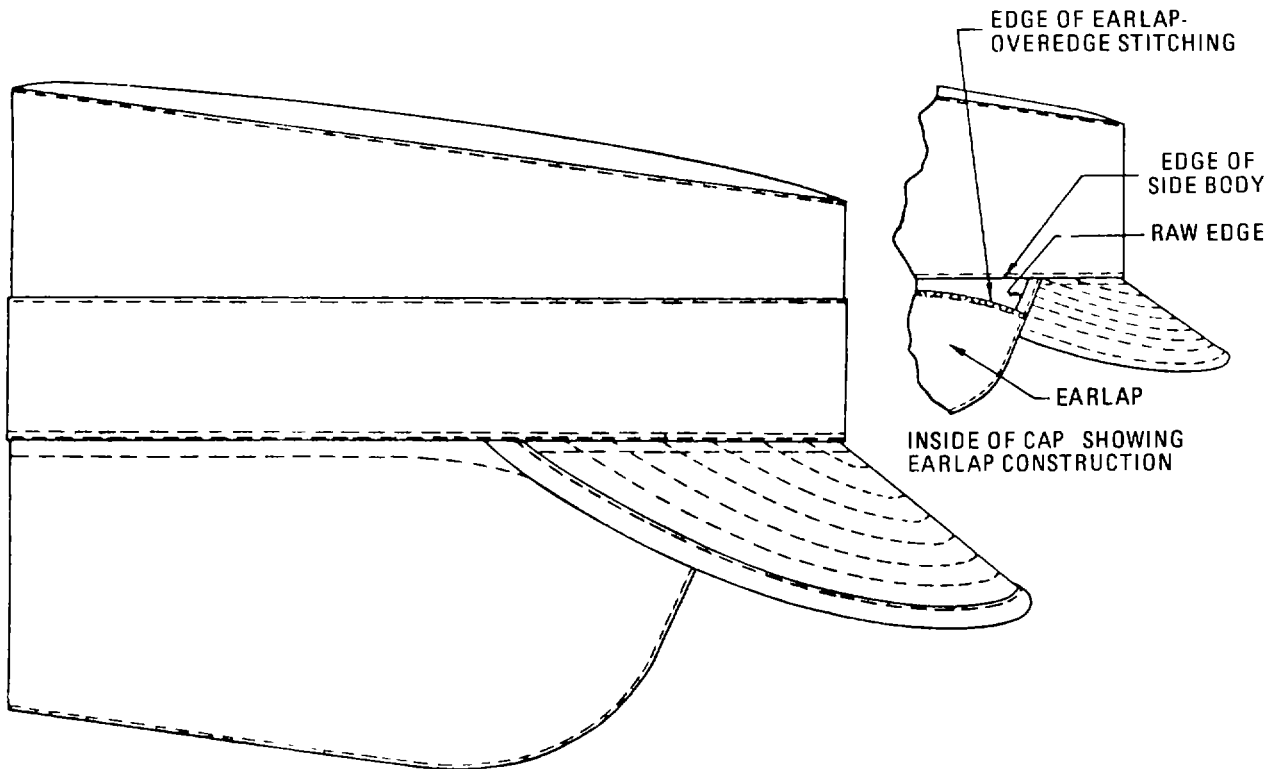

Figure 8-5. Cap, combat, woodland camouflage pattern

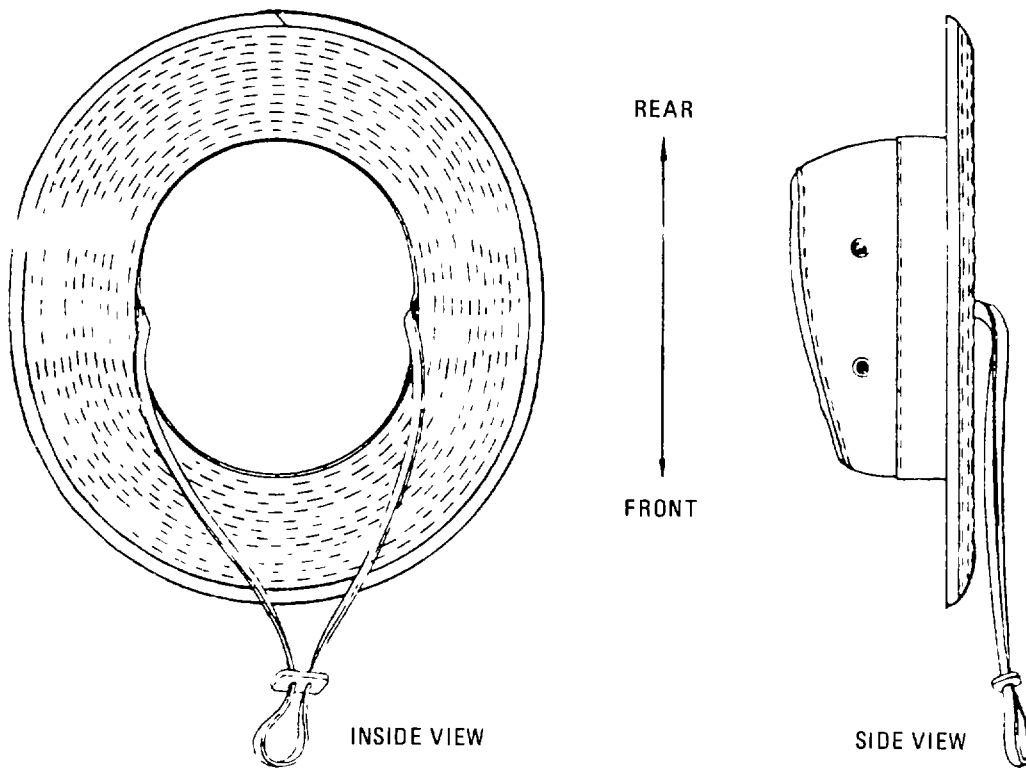

Figure 8-6. Hat, camouflage pattern: desert

Section II. REPAIR PROCEDURES

8-5. MATERIALS

Materials used in the repair of hats, caps, and hood will be serviceable materials recovered from similar salvaged items, when authorized, or will be new materials which will be requisitioned from stock under the stock number and/or item descriptions as listed in section III of this manual. When not available from stock, the materials may be purchased locally when they conform to the standard material.

8-6. CLASSIFICATION

Refer to chapter 1 for material classification code explanation.

8-7. REPAIR AND MAINTENANCE

Prior to repair operations, each item shall be inspected to determine the amount of repair necessary. Repairs will be made as fully as skills, facilities, funds, and local conditions permit.

a. Organizational Maintenance

- (1) Cleaning. Thoroughly clean the item of mud or other foreign matter with damp or dry cloth or by scrubbing with clear water.
- (2) Repair. Replace missing or defective buttons.

b. Direct Support Maintenance.

- (1) Cleaning and laundering. Items which cannot be satisfactorily cleaned by brushing will be dry cleaned in Army dry-cleaning facilities in accordance with established practices set forth in FM 10-280. When such facilities are not available, items will be laundered by contract with private industry in accordance with accepted commercial laundry practices. Quarpel treated items such as w/fur and camouflage hat will require thorough rinsing and removal of cleaning compounds to assure retention of waterproof characteristics.
- (2) Repair.
 - (a) Stitching. For illustrations of the various types of stitches used, see Fed-Std-751. The following types of stitch, thread size, and stitches per inch are to be used as applicable to the repair (table 8-1).

8-7. REPAIR AND MAINTENANCE-Continued

Table 8-1. Stitching Instructions

COLD WEATHER HOOD

LOCATION	STITCH TYPE	THREAD	STITCHES PER INCH
General	301	50/3	10-14
Bartack	--	50/3	28
Buttonhole	--	50/3	45
Nylon Tape Fasteners	301	30/3	10-14
Buttons	301	30/3	14-16

COLD WEATHER CAP

General	301	50/3	10-14
Buttonholes	--	50/3	76-80
Bartack	--	50/3	28
Nylon Tape Fasteners	301	50/3	10-14

HOT WEATHER CAP

General	301	50/3	10-14
Overedging	502 or 503	50/3	6-8

CAP COMBAT CAMOUFLAGE

General	301	50/3	10-14
Overedging	502 or 503	50/3	6-10

CAMOUFLAGE HATS AND INSECT NET

General	301	50/3	10-14
Overedging	502 or 503	50/3	6-10
Bartack	--	50/3	28

NOTE: All thread shall be dyed olive drab shade S-1, CA 66022, except for the desert hat which shall be shade P-1, CA66019. The polyester-cotton covered thread shall be water repellent treated for the cold weather hood, cold weather cap and combat cap in accordance with type II, class 3 of MIL-T-3530. Lubrication of the quarpel treated sewing thread is prohibited.

8-7. REPAIR AND MAINTENANCE-Continued

- (b) Sewing Instructions. Items having frayed edges will be overedge stitched, using stitch type 501, 503, or 505. All sewing except emergency repair will be machine sewing. Match all stitches and seams to those used in the original construction. Maintain proper thread tension so that thread locks will be imbedded in the center of material to prevent loose stitches. Restitch seams with loose or broken thread by stitching back of the break not less than 1/2 inch (1.27 cm). Backstitch thread ends 1/4 inch (0.635 cm), except when ends are turned under in a hem or held down by other stitching.
 - (c) Re-seam. Stitching on replacement sections and restitching of seams will be the same as an original construction. When stitch type 401 is used, place the looped thread on the underside. Backstitch all stitching no less than 1 inch (2.54 cm) at each break or end to prevent raveling. Maintain proper thread tensions and properly imbedded stitches to prevent loose stitching. Overlock thread breaks 3/4 inch (1.91 cm) at each break. Resew all broken stitching by back stitching two inches on each side of the break.
- (3) Darning. Darn rips or tears not larger than 1/4 inch (0.635 cm) limiting to three per hood or cap section.

NOTE

Repairs such as mends, darns, patches, or splices are not permitted on the camouflage pattern cap. (Re: MIL-C-1911H, pg 7, para 3.4.2)

- (4) Replacements.
- (a) Replace defective sweatbands with material specified in section III.
 - (b) Replace missing or defective drawcords with webbing specified in section III, cut as follows, and attach in same manner as the original. One end of each drawcord shall be tacked to brim and hood joining seam allowance through interlining and hood. Thread through eyelet and keeper. Knot ends and coat tips with cellulose acetate or cellulose butyrate to prevent fraying (fig. 8-1).
 - (c) Replace missing or defective buttons with like items specified in section III and restitch all loose buttons.
 - (d) Repair buttonholes having loose or broken stitching, and loose or broken gimp or tack. Reshape enlarged buttonholes by reinforcing hole with a small piece of like material and rework. Restitch damaged tack and replace defective gimp with material specified in section III.
 - (e) Replace missing or defective leather keepers using material specified in section III, fabricated to size and design of the original.

8-7. REPAIR AND MAINTENANCE-Continued

- (f) Replace missing or defective drawcord eyelets with material specified in section III.
 - (g) Replace missing or defective hardware with items identical in design, dimensions, and color to pieces being replaced.
- (5) Sizing. After repair and/or laundering, size all Items, using tables listed below. Check sizes with original markings and change if necessary. Hoods that do not meet size requirements of table 8-2A below will not be reissued for wear. All size markings will be stamped out with indelible ink. Size all caps and hats in accordance with table 8-2. When measurements do not conform with the table, mark with the next lower size.

**Table 8-2. Resizing Instructions
(FINISHED MEASUREMENTS IN INCHES)**

A - COLD WEATHER HOOD

LOCATION	INCHES	TOLERANCE	
		PLUS	MINUS
*OVERALL LENGTH	34	3/4	1/2
**NECK	24	3/4	1/2
***BRIM WIDTH	4 1/2	1/4	1/4
STORM CURTAIN WIDTH	6 5/8	1/4	1/4
***SKIRTWIDTH	4 1/4	1/4	1/4

- * Overall length. Measure from bottom of storm curtain to front edge of brim in alignment with center seam at top of hood.
- ** Neck. Measure along length of seam which joins skirt to hood on inside.
- *** Brimwidth. } Measure in alignment with center panel at
 Skirt width. } top of hood.

8-7. REPAIR AND MAINTENANCE-Continued

Table 8-2. Resizing Instructions-Continued

**B - COLD WEATHER CAP
(CAP MEASUREMENT IN INCHES)**

	CAP SIZE						TOLERANCE
	6 1/2	6 3/4	7	7 1/4	7 1/2	7 3/4	
* Inside Circumference	21	21 3/4	22 1/2	23 1/4	24	24 3/4	+ 1/2
** Back length	7 3/8	7 7/8	8 3/8	8 7/8	9 3/8	9 7/8	+ 3/8
*** Gusset width	2	2	2	2	2	2	+ 1/4

* Inside circumference. Measure the inside circumference at center of sweatband without stretching.

** Back length. Measure from top crown seam at center back, through center of gusset to outside edge of binding.

*** Gusset width. Measure across top of gusset at top crown joining seam.

C - HOT WEATHER HAT

SIZE	* INSIDE CAP MEASUREMENTS	TOLERANCE ALL MEASUREMENTS
6 3/8	20 3/8	± 1/8
6 1/2	20 3/4	
6 5/8	21 1/8	
6 3/4	21 1/2	
6 7/8	21 7/8	
7	22 1/4	
7 1/8	22 5/8	
7 1/4	23	
7 3/8	23 3/8	
7 1/2	23 3/4	
7 5/8	24 1/8	
7 3/4	24 1/2	
7 7/8	24 7/8	

* Inside cap measurements: Measure along bottom edge of sweatband.

8-7. REPAIR AND MAINTENANCE-Continued

Table 8-2. Resizing Instructions - Continued

D - HAT AND INSECT NET/HOT WEATHER SUN HAT

SIZE	* INSIDE HAT (HEAD MEASUREMENTS)	** CROWN HEIGHT AT CENTER FRONT	***CROWN HEIGHT AT CENTER BACK	BRIM WIDTH
6 3/8	20 1/2	2 3/4 All sizes	3 1/2 All sizes	2 3/8 All sizes (Type I hat)
6 1/2	20 7/8			
6 5/8	21 1/4			
6 3/4	21 5/8			
6 7/8	22			3
7	22 3/8			All sizes
7 1/8	22 3/4			(Types II and III hats)
7 1/4	23 1/8			
7 3/8	23 1/2			
7 1/2	23 7/8			
7 5/8	24 1/4			
7 3/4	24 5/8			
7 7/8	25			

Tolerance: All measurements $\pm 1/4$.

* Measure along bottom edge of side lining.

**Measure from base of side to crown seam on outside of center front.

*** Measure from base of side to crown seam on outside of center back.

E - CAMOUFLAGE CAP

SIZE	* INSIDE CAP MEASUREMENTS	TOLERANCE FOR MEASUREMENT
6 3/8	20 1/8	$\pm 1/4$
6 1/2	20 1/2	
6 5/8	20 7/8	
6 3/4	21 1/4	
6 7/8	21 5/8	
7	22	
7 1/8	22 3/8	
7 1/4	22 3/4	
7 3/8	23 1/8	$\pm 1/4$
7 1/2	23 1/2	
7 5/8	23 7/8	
7 3/4	24 1/4	

* Inside cap measurements. All caps shall be measured with the earflaps inside the cap.

8-7. REPAIR AND MAINTENANCE-Continued

Table 8-2. Resizing Instructions - Continued

F - DESERT HAT

SIZE	* INSIDE HAT (HEAD MEASUREMENTS)	** CROWN HEIGHT AT CENTER FRONT	***CROWN HEIGHT AT CENTER BACK	BRIM WIDTH
6 3/8	20 1/2	2 3/4	3 1/2	2 3/8
6 1/2	20 7/8	All sizes	All sizes	All sizes
6 5/8	21 1/4			
6 3/4	21 5/8			
6 7/8	22			
7	22 3/8			
7 1/8	22 3/4			
7 1/4	23 1/8			
7 3/8	23 1/2			
7 1/2	23 7/8			
7 5/8	24 1/4			
7 3/4	24 5/8			
7 7/8	25			

Tolerance All measurements $\pm 1/4$

* Measure along bottom edge of side lining.

** Measure from base of side to crown seam on outside of center front.

*** Measure from base of side to crown seam on outside of center back.

- (6) Instruction labels. Cut away faded or missing instructions labels and replace with new labels in same location, using type 301 stitch and label cloth specified at each garment label description. Print labels with black indelible ink.
- (a) Cold Weather Hood. The Instruction label shall conform to type I, class 1 of DD-L-20 and contain the following information.

**HOOD, EXTREME COLD WEATHER,
W/SYNTHETIC FUR RUFF, OG-107**

1. Attachment to Field Coat or M-65 Parka:
 - a. Fasten skirt buttonholes to 4 buttons on inside of garment (only 2 on coat).
 - b. Turn garment and fasten 2 storm curtain buttons to collar.
 - c. Fasten side storm curtain buttonholes to shoulder loop buttons on coat.

8-7. REPAIR AND MAINTENANCE-Continued

- d. Secure stud on skirt to socket on side of garment.
- e. Secure loop to coat button. Not required for Parka.
- 2. Attachment to (older type) M-51 Parka (with attached hood):
 - a. Align storm curtain and skirt buttonholes and fasten to 4 inside parka buttons.
 - b. Pull parka hood over insulating hood and secure crown buttons. Adjust parka hood drawstrings.
 - c. This hood is large enough to wear over steel helmet. Parka hood is not Omit step b when wearing helmet.
- 3. Use of hood (over bare head, cap, or helmet)
 - a. Adjust hood drawstrings for comfort, securing keeper to maintain fit. Adjust hood brim for maximum protection.
 - b. Open front closure or remove hood from head for ventilation.
 - c. Shake frost accumulation from fur frequently.

CAUTION

Do not tumble dry.

- d. Launder hood by hand, shake out water and air dry, or machine launder in accordance with Wool Method, Formula II, FM 10-280, *except* air dry.
- (b) Hot weather cap. The instruction label shall conform to type I, class 3, and measure not less than 2-1/2 by 1 inch (6.35 by 2.54 cm), containing the following information-

CAP, FIELD, HOT WEATHER

LAUNDERING INSTRUCTIONS

DO NOT USE HOT WATER, STRONG
SOAP OR DETERGENT

HAND WASH IN LUKEWARM WATER AND
AIR DRY OR LAUNDER AS A WOOLEN
ITEM

8-7. REPAIR AND MAINTENANCE-Continued

- (c) Hat and insect net and hat, sun, hot weather. The instruction label shall conform to type IV, class 3, and shall measure not more than 2 inches (5.08 cm) by 2 inches (5.08 cm). The label shall include the following information:

HAT AND INSECT NET OG 107
(OR HAT, SUN, HOT WEATHER)
 CAUTION
 INITIAL LOOSE FIT REQUIRED FOR
 CONTINUED COMFORT
 LAUNDERING
 SPOT WASH BADLY SOILED AREAS.
 WASH IN HOT WATER (140°) USING SOAP
 OR DETERGENT
 RINSE AT LEAST 3 TIMES TO RESTORE
 WATER REPELLENCY.
 MACHINE SPIN OR SQUEEZE BY HAND.
 MACHINE DRY AT MODERATE HEAT OR
 HAND TO DRY.
 DO NOT STARCH.

- (d) Cap, Cold Weather. The instruction label shall conform to type VI, class 3 and shall contain the following information:

CAP, COLD WEATHER, INSULATING, HELMET LINER.

1. Wear straight on head with forehead flap up or down.
2. Fasten earflaps under or over chin, and back of neck or over head.
3. When worn under helmet with earflaps over helmet, thread helmet chin strap through buttonholes.
4. Launder by the Wool Method, Formula II, FM 10-280 except dry tumble heat shall not exceed 130°F; or hand wash in lukewarm water.

DO NOT REMOVE THIS LABEL

- (e) Cap, Combat. The instruction label shall conform to type VI, class 3 and shall contain the following information:

CAP, CAMOUFLAGE PATTERN

1. Do not wear cap in cold weather environments. Use Cap, Cold Weather, insulating Helmet Liner.
2. If cap is worn under helmet, helmet headband may require readjustment for proper fit and comfort.

8-7. REPAIR AND MAINTENANCE-Continued

3. Machine Wash. Use permanent press cycle. Wash in warm water with mild detergent.
4. Hand Wash. Hand wash in warm water using mild detergent. Do not wring or twist. Rinse in clean warm water.
5. Do not use chlorine bleach or starch.
6. Dry at low heat (Do not exceed 130°F).

DO NOT REMOVE THIS LABEL

- (f) Desert Hat. The instruction label shall conform to type VI, class 3 and shall measure not more than 3 inches by 2 inches (7.62 by 5.08 cm). The label shall contain the following information:

HAT, CAMOUFLAGE PATTERN DESERT

1. CAUTION-Initial loose fit required for continued comfort.
2. Machine Wash. Use permanent press cycle. Wash in warm water with mild detergent.
3. Hand Wash. Hand wash in warm water using mild detergent. Rinse in clean warm water.
4. Do not use chlorine bleach or starch.
5. Dry at low heat (Do not exceed 130°F). Or hang to dry.

DO NOT REMOVE THIS LABEL

8-8. WORKMANSHIP

Repair and cleaning will be done by personnel skilled in the particular trade applicable to their duties in the maintenance of hats, caps and hoods. Patches will be tightly sewn or applied, and all reseaming will be secured and free of loose or broken thread. The finished item will be complete, clean, well repaired, and free from all defects affecting its serviceability.

8-9. INSPECTION

The inspection or quality control unit is responsible for determining compliance with repair instructions and requirement for classification. In-process inspections will be performed for quality of workmanship, and correct application of repair procedures. The complete item will be inspected for serviceable appearance and condition to insure against return of a substandard product to supply channels.

Section III. MATERIALS

SMR CODE	NATIONAL STOCK NUMBER	DESCRIPTION	UNIT OF MEAS.
PAF	8305-00-901-2291	HOOD, EXTREME COLD WEATHER, W/FUR RUFF; OG107, M-65	
		Cloth, Oxford, Cotton Warp, and Nylon Filling; Conform to Class 2, Quarpel Treated, Dyed Olive Green 107 of MIL-C-3924.	YD
F	NONE	Braid, Cotton Tubular, 1/8 inch, OG 107, Conform to Type IV, Class 2 of MIL-B-371. Source of Supply: A.H Rice Co , Pittsfield, Mass.	
PAF	8310-01-0914032	Thread, Cotton Covered Rayon or Polyester, Ticket No 30/3 Ply, Olive Drab S-1, Conforming to MIL-T-43548	CE
PAF	8310-01-066-0973	Thread, Cotton Covered Rayon or Polyester, Ticket No. 50/3 Ply Olive Drab S-1 Conforming to MIL-T-43548 and Water Repellent Treated in Accordance With Type II, Classes 2 & 3 of MIL-T-3550	CE
PAF	8310-00-262-0094	Gimp. Cotton: Conform to Type I or II, Size 8. S-1. Cable No. 66022 of V-T-280	SL
PAO	8315-00-269-1359	Buttons: Conform to Type II, Class D, Style 20, 30-Line of V-B-871	GR
		CAP, COLD WEATHER	
PAF	8303-00-901-2991	Cloth, Oxford, Cotton Warp and Nylon Filling. Conform to Class 2 of MIL-C-3924.	YD
PAF	8310-01-066-0973	Thread Cotton Covered Rayon or Polyester, Ticket No 50/3 Ply Olive Drab S-1, Conforming to MIL-T-43548, and Water Repellent Treated in Accordance with Type II, Classes 2 & 3 of MIL-T-3530	CE

Section III. MATERIALS - Continued

SMR CODE	NATIONAL STOCK NUMBER	DESCRIPTION	UNIT OF MEAS.
		CAP, HOT WEATHER	
PAF	8305-01-033-4410	Cloth, Polyester/Cotton Twill, Conform to Type II, Class 2, OG 507 of MIL-C-43791	YD
PAF	8310-01-066-0973	Thread, Cotton-Covered, Rayon or Polyester, Ticket No 50/3 Ply, Shade OD, S-1 Conforming to MIL-T-43548	YD
		HAT AND INSECT NET	
PAF	8305-00-935-3160	Netting, Nylon Tricot; Conform to Class 2, Dark Green 323.	YD
PAF		Laces, Nylon, Conform to Type II, Class 2, 8/32 inch Wide of V-L-61.	YD
		CAP, COMBAT, WOODLAND CAMOUFLAGE PATTERN	
PAF	8305-01-084-1669	Cloth, Oxford, Cotton Warp and Nylon Filling, Conforming to Class 3, Quarrel Treated Camouflage Printed of MIL-C-3924 and Class 2, OG 107 of MIL-C-3924	TD
PAF	8305-00-901-2991	Cloth, Flannel, Wool and Nylon, Conforming to Type III, OG 108 of MIL-C-3760	YD
PAF	8310-01-066-0973	Thread, Cotton-Covered, Rayon or Polyester, Ticket No 50/3 Ply, Olive Drab S-1, Conforming to MIL-C-43548 and Water Repellent Treated in Accordance With Type II, Classes 2 & 3 of MIL-T-3530	CE
		HAT, SUN, HOT WEATHER	
PAF		Cloth, Cotton, Wind-Resistant, Rip-stop Poplin, Camouflage Pattern Conforming to Type IV of MIL-C-43468	YD
		HAT, DESERT, CAMOUFLAGE	
PAF	8305-01-102-6774	Cloth, Camouflage Pattern, Cotton and Nylon for Daytime Desert Uniform Conforming to MIL-C-44034	YD
		Laces, Nylon, Conforming to Type II Class 2 of V-L-61	YD

CHAPTER 9

MAINTENANCE OF MEN'S SERVICE COATS, OVERCOATS AND ALL-WEATHER COATS

Section I. INTRODUCTION

9-1. SCOPE

This chapter prescribes the procedures and instructions for repair of the man's AG 344 polyester/wool serge coats and man's black shade 385 All-Weather coat with removable liner.

9-2. COMMODITY SPECIFICATION

a. Items.

ITEM	SPECIFICATION
Coat, Man's, Poly/Wood Serge AG-344-All Seasons	MIL-C-44211
Coat, All-Weather; Man's Black, with Removable Liner	MIL-C-44030

b. Components.

ITEM	SPECIFICATION
Button, Sewing, Hole; and Button, Staple, Plastic	V-B-871
Fasteners, Slide, Interlocking	V-F-106
Thread, Cotton Gimp, Buttonhole	V-T-280
Cloth, Buchram, Cotton	CCC-C-438
Tape, Textile, Cotton, General Purpose	DDD-T-86
Cloth, Silesia, Cotton	MIL-C-326
Cloth, Satin, Rayon; and Cloth, Twill, Rayon	MIL-C-368
Braid, Textile, Flat	MIL-B-593
Cloth, Serge, Wool, Wool and Nylon	MIL-C-823
Buckle, Slide, Plastic	MIL-B-1860
Cloth, Flannel, Wool Lining, 12 ounce	MIL-C-3191
Buttons, Insignia, Metal; Uniform and Cap	MIL-B-3461
Cloth, Gabardine, Wool, Polyester and Wool	MIL-C-10176
Cloth, Wigan, Cotton	M L-C-16375
Cloth, Tropical	MIL-C-21115
Braid, Textile, Tubular	MIL-B-371
Thread and Twine, Mildew Resistant or Water Repellent Treated	MIL-T-3530
Cloth, Taffeta, Nylon (2 0 ounce)	MIL-C-21852
Cloth, Pile, Acrylic Fiber Pile	MIL-C-43251
Cloth, Poplin, Cotton, and Polyester (Water Repellent)	MIL-C-43482

c. Technical Publications. Publications not listed in Chapter I
 FM 10-300 Fixed Dry Cleaning Plant

9-3. IDENTIFICATION AND DESCRIPTION

- a. Coat, Man's: Polyester/Wool; Army Green Shade 344.

NSN	SIZES	SPECIFICATION
8405-01-1056063 through 6127	(table 9-1)	MIL-C-44211

The shade 344 man's polyester/wool coat is intended for wear as part of the service or semidress uniform. It is a four-button, single-breasted, half-lined coat with collar and peak lapels. The coat has two top pleated patch pockets and two lower inside-hanging pockets, all with flaps; and one inside breast pocket. It has a two-piece back with center vent, waist darts for form fit, and shoulder loops with buttons.

- b. Coat, All-Weather. Man's, With Removable Liner.

NSN	SIZES	SPECIFICATION
8405-01-0594225 through 4266	(table 9-4 and 9-5)	MIL-C-44030

The shade 385 cotton and polyester water repellent poplin coat is a single-breasted four (4) button fly front, split shoulder (set-in front raglan back) with a front and back yoke lining. The coat has slash pockets with inside hanging bellows which are two-way access (pass through pockets). The back has a center vent with button and buttonhole. The collar is convertible with a half stand and has a throat tab for collar closure. The shoulder loops are detachable. The coat has a detachable single ply liner with bound edges, raglan sleeves, button and loop at the sleeve bottom, a slide fastener for attaching to coat, and a pass through pocket slit (opening).

9-3. IDENTIFICATION AND DESCRIPTION-Continued

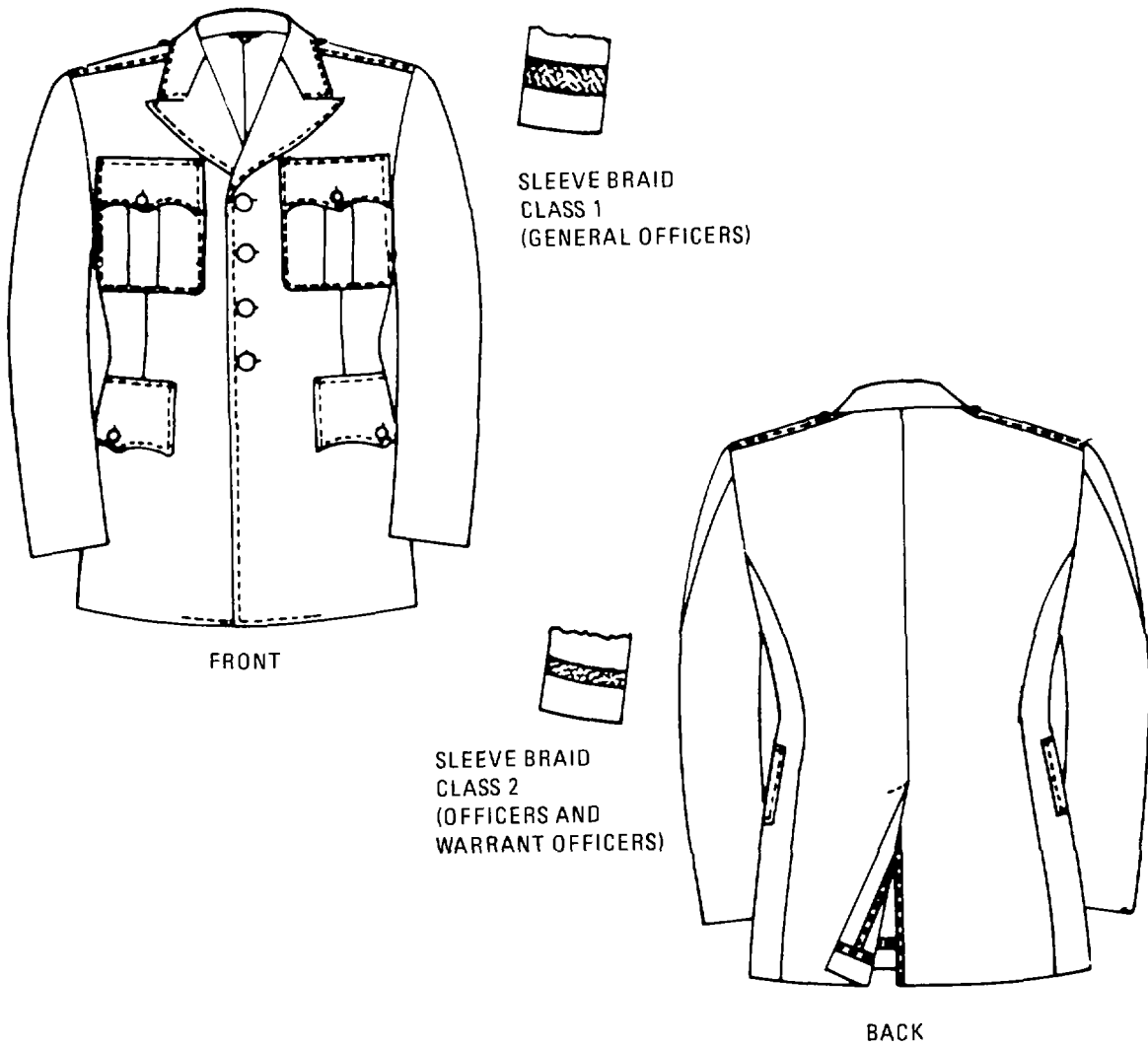

Figure 9-1. Men's polyester/wool service coat.

9-3. IDENTIFICATION AND DESCRIPTION-Continued

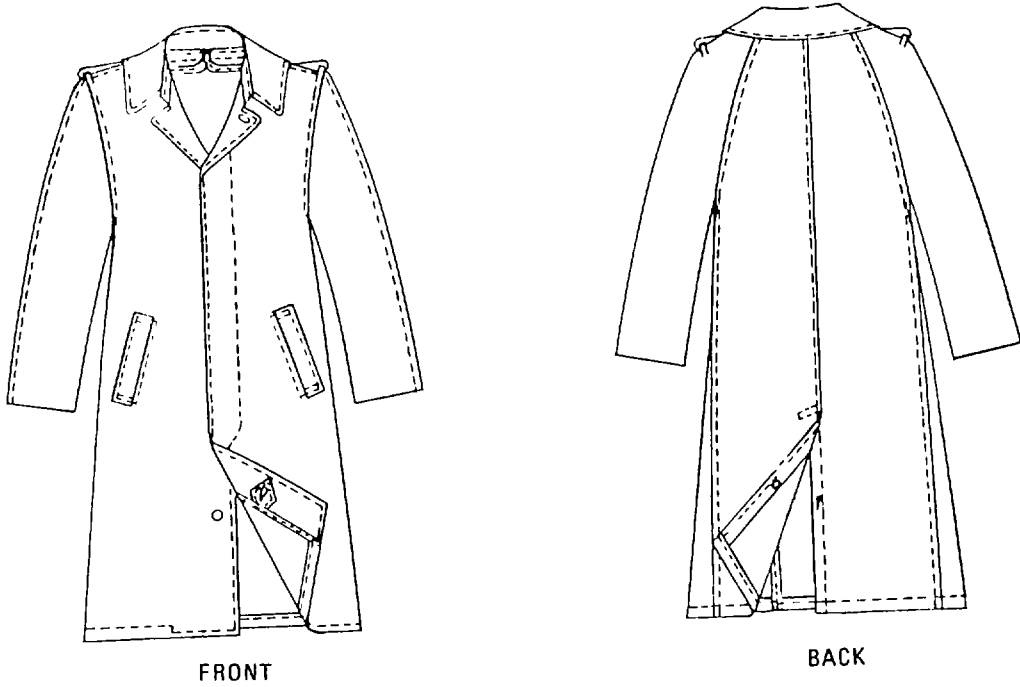

Figure 9-2. Man's cotton and polyester poplin all-weather coat.

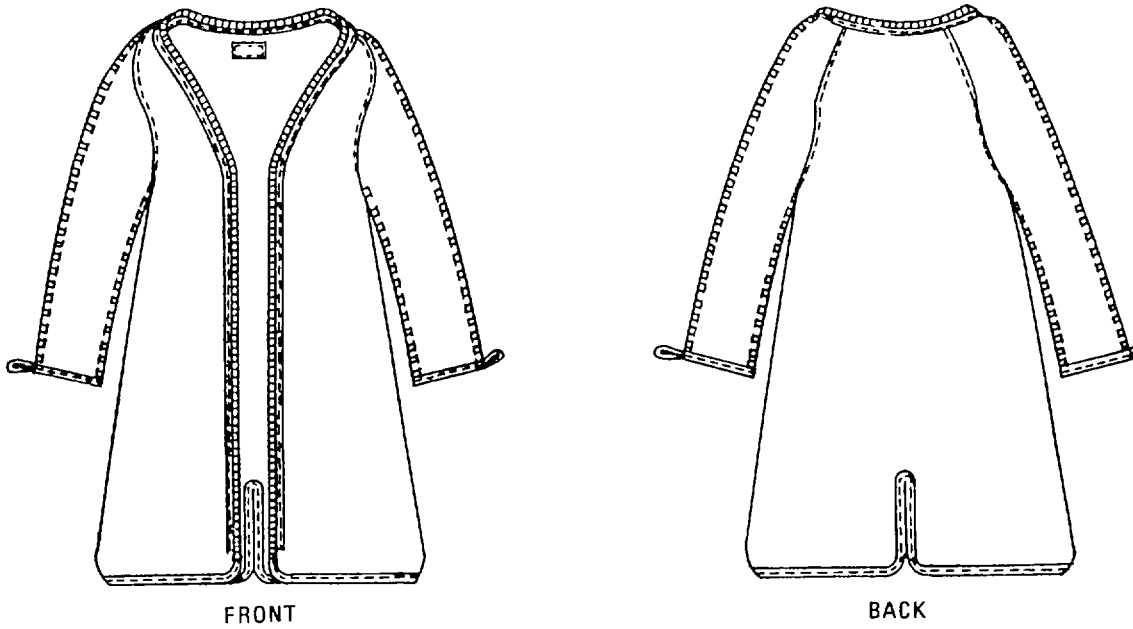

Figure 9-3. Man's acrylic fiber pile liner for all-weather coat

9-3. IDENTIFICATION AND DESCRIPTION-Continued

Table 9-1. Measurements for Men's Coats

SIZE	1/2 BREAST ¹	SLEEVE LENGTH ²	BACK LENGTH ³
<i>Extra Short.</i>	<i>Inches</i>	<i>Inches</i>	<i>Inches</i>
34	18-3/4	15	26-3/4
35	19-1/4	15-1/8	27
36	19-3/4	15-1/4	27-1/4
37	20-1/4	15-3/8	27-1/2
38	20-3/4	15-3/8	27-3/4
39	21-1/4	15-1/2	28
40	21-3/4	15-1/2	28-1/4
41	22-1/4	15-1/2	28-3/8
42	22-3/4	15-1/2	28-1/2
Tolerance:			
Plus	1/2	1/2	1/2
Minus	1/2	3/8	1/2
<i>Short.</i>	<i>Inches</i>	<i>Inches</i>	<i>Inches</i>
32	17-3/4	15-3/4	28-1/4
33	18-1/4	15-7/8	28-1/2
34	18-3/4	16	28-5/8
35	19-1/4	16-1/8	28-7/8
36	19-3/4	16-1/4	29
37	20-1/4	16-3/8	29-1/8
38	20-3/4	16-3/8	29-3/8
39	21-1/4	16-1/2	29-1/2
40	21-3/4	16-1/2	29-3/4
41	22-1/4	16-1/2	29-7/8
42	22-3/4	16-1/2	30
43	23-1/4	16-1/2	30-1/8
44	23-3/4	16-1/2	30-3/8
46	24-3/4	16-1/2	30-1/2
48	25-3/4	16-1/2	30-3/4
50	26-3/4	16-1/2	31-1/8
Tolerance:			
Plus	1/2	1/2	1/2
Minus	1/2	3/8	1/2

9-3. IDENTIFICATION AND DESCRIPTION-Continued

Table 9-1. Measurements for Men's Coats-Continued

SIZE	1/2 BREAST ¹	SLEEVE LENGTH ²	BACK LENGTH ³
Regular	<i>Inches</i>	<i>Inches</i>	<i>Inches</i>
30	16-3/4	16-1/2	29-3/8
31	17-1/4	16-5/8	29-1/2
32	17-3/4	16-3/4	29-5/8
33	18-1/4	16-7/8	29-3/4
34	18-3/4	17	30
35	19-1/4	17-1/8	30-1/8
36	19-3/4	17-1/4	30-1/4
37	20-1/4	17-3/8	30-3/8
38	20-3/4	17-3/8	30-5/8
39	21-1/4	17-1/2	30-3/4
40	21-3/4	17-1/2	31
41	22-1/4	17-1/2	31-1/8
42	22-3/4	17-1/2	31-1/4
43	23-1/4	17-1/2	31-3/8
44	23-3/4	17-1/2	31-1/2
46	24-3/4	17-1/2	31-3/4
48	25-3/4	17-1/2	32
50	26-3/4	17-1/2	32-3/8
Tolerance:			
Plus	1/2	1/2	1/2
Minus	1/2	3/8	1/2
Long	<i>Inches</i>	<i>Inches</i>	<i>Inches</i>
33	18-1/4	18-1/8	31-1/8
34	18-3/4	18-1/4	31-3/8
35	19-1/4	18-3/8	31-1/2
36	19-3/4	18-1/2	31-3/4
37	20-1/4	18-5/8	32
38	20-3/4	18-5/8	32-1/8
39	21-1/4	18-3/4	32-1/4
40	21-3/4	18-3/4	32-1/2
41	22-1/4	18-3/4	32-5/8
42	22-3/4	18-3/4	32-3/4
43	23-1/4	18-3/4	32-7/8
44	23-3/4	18-3/4	33
46	24-3/4	18-3/4	33-1/4
48	25-3/4	18-3/4	33-1/2
Tolerance:			
Plus	1/2	1/2	1/2
Minus	1/2	3/8	1/2

9-3. IDENTIFICATION AND DESCRIPTION-Continued

Table 9-1. Measurements for Men's Coats-Continued

SIZE	1/2 BREAST ¹	SLEEVE LENGTH ²	BACK LENGTH ³
Extra Long:	<i>Inches</i>	<i>Inches</i>	<i>Inches</i>
36	19-3/4	20	33-1/2
37	20-1/4	20-1/8	33-3/4
38	20-3/4	20-1/8	33-7/8
39	21-1/4	20-1/4	34
40	21-3/4	20-1/4	34-1/4
41	22-1/4	20-1/4	34-3/8
42	22-3/4	20-1/4	34-1/2
43	23-1/4	20-1/4	34-5/8
44	23-3/4	20-1/4	34-3/4
46	24-3/4	20-1/4	35
48	25-3/4	20-1/4	35-1/4
Tolerance			
Plus	1/2	1/2	1/2
Minus	1/2	1/2	1/2

¹ 1/2 breast measurement taken with coat buttoned from folded edge to folded edge in line with pit of armhole.

² Sleeve length measurement taken along inseam from pit of armhole to bottom of sleeve.

³ Back measurement taken along center back seam from undercollar seam to bottom of coat.

9-3. IDENTIFICATION AND DESCRIPTION-Continued

Table 9-2. Measurements for Men's All-Weather Coat

SIZE	1/2 BREAST ¹	BACK LENGTH ²	SLEEVE LENGTH ³
Extra short:			
32	21-1/8	39-1/8	15-7/16
34	22-7/8	39-3/8	15-7/16
36	23-5/8	39-5/8	15-1/2
38	24-5/8	39-7/8	15-1/2
40	25-5/8	40-1/8	15-9/16
42	26-5/8	40-3/8	15-5/8
Short:			
30	21-3/8	40-3/8	16-1/2
32	22-1/8	40-5/8	16-1/2
34	22-7/8	40-7/8	16-1/2
36	23-5/8	41-1/8	16-1/2
38	24-5/8	41-3/8	16-1/2
40	25-5/8	41-5/8	16-1/2
42	26-5/8	41-7/8	16-5/8
44	27-5/8	42-1/8	16-3/4
46	28-5/8	42-3/8	16-3/4
Regular:			
30	21-3/8	42-3/8	17-7/16
32	22-1/8	42-5/8	17-7/16
34	22-7/8	42-7/8	17-7/16
36	23-5/8	43-1/8	17-1/2
38	24-5/8	43-3/8	17-1/2
40	25-5/8	43-5/8	17-1/2
42	26-5/8	43-7/8	17-1/2
44	27-5/8	44-1/8	17-5/8
46	28-5/8	44-3/8	17-5/8
48	29-5/8	44-5/8	17-5/8
Long:			
32	22-1/8	44-5/8	18-1/2
34	22-7/8	44-7/8	18-1/2
36	23-5/8	45-1/8	18-1/2
38	24-5/8	45-3/8	18-9/16
40	25-5/8	45-5/8	18-9/16
42	26-5/8	45-7/8	18-5/8
44	27-5/8	46-1/8	18-11/16
46	28-5/8	46-3/8	18-11/16
48	29-5/8	46-5/8	18-3/4

9-3. IDENTIFICATION AND DESCRIPTION-Continued

Table 9-2. Measurements for Men's All-Weather Coat-Continued

SIZE	1/2 BREAST ¹	BACK LENGTH ²	SLEEVE LENGTH ³
Extra Long:			
34	22-7/8	46-7/8	19-3/8
36	23-5/8	47-1/8	19-1/2
38	24-5/8	47-3/8	19-1/2
40	25-5/8	47-5/8	19-1/2
42	26-5/8	47-7/8	19-1/2
44	27-5/8	48-1/8	19-5/8
46	28-5/8	48-3/8	19-11/16
48	29-5/8	48-5/8	19-3/4
Tolerances:	Plus 1/2 Minus 1/2	Plus 1/2 Minus 1	Plus 1/2 Minus 1/2

The coat shall be buttoned without liner, placed flat on a table and measured as follows.

¹ 1/2 Breast-Measure from folded edge to folded edge at base of armhole across the front.

² Back length-Measure from undercollar seam down center back to bottom of coat

³ Sleeve length-Measure underarm seam from armhole seam to bottom of sleeve

Table 9-3. Measurements for Men's Liner for All-Weather Coat

SIZE	1/2 BREAST ¹	BACK LENGTH ²	SLEEVE LENGTH ³
Extra short:			
32	18-1/2	34 1/8	14-7/8
34	19-1/4	34-3/8	14-7/8
36	20	34-5/8	15
38	21	34-7/8	15
40	22	35-1/8	15
42	23	35-3/8	15
Short:			
30	17-3/4	33-7/8	15-7/8
32	18-1/2	34-1/8	15-7/8
34	19-1/4	34-3/8	15-7/8
36	20	34-5/8	15-7/8
38	21	34-7/8	16
40	22	35-1/8	16
42	23	35-3/8	16-1/8
44	24	35-5/8	16-1/8
46	25	35-7/8	16-1/4

9-3. IDENTIFICATION AND DESCRIPTION-Continued

Table 9-3. Measurements for Men's Liner for All-Weather Coat-Continued

SIZE	1/2 BREAST ¹	BACK LENGTH ²	SLEEVE LENGTH ³
Regular:			
30	17-3/4	35-1/2	16-7/8
32	18-1/2	35-3/4	16-7/8
34	19-1/4	36	16-7/8
36	20	36-1/4	17
38	21	36-1/2	17
40	22	36-3/4	17
42	23	37	17
44	24	37-1/4	17
46	25	37-1/2	17-1/8
48	26	37-3/4	17-1/8
Long:			
32	18-1/2	37-1/8	17-7/8
34	19-1/4	37-3/8	17-7/8
36	20	37-5/8	17-7/8
38	21	37-7/8	17-7/8
40	22	38-1/8	17-7/8
42	23	38-3/8	18
44	24	38-5/8	18-1/8
46	25	38-7/8	18-1/8
48	26	39-1/8	18-1/4
Extra Long:			
34	19-1/4	37-3/8	18-7/8
36	20	37-5/8	19
38	21	37-7/8	19
40	22	38-1/8	19
42	23	38-3/8	19
44	24	38-5/8	19-1/8
46	25	38-7/8	19-1/4
48	26	39-1/8	19-5/16
Tolerances:	Plus 1/2 Minus 1/2	Plus 1/2 Minus 1	Plus 1/2 Minus 1/2

The liner shall be placed flat on a table and measured as follows:

- ¹ 1/2 Breast-Fold liner in half (down center back) and measure from front edge to back folded edge at base of armhole.
- ² Back length-Measure from neck edge to bottom of liner.
- ³ Sleeve length-Measure underarm seam from sleeve joining seam to bottom of sleeve

Section II. REPAIR PROCEDURES

9-4. MATERIALS

Materials used in the repair of coats and overcoats shall be serviceable materials recovered from similar salvaged items when authorized, or will be new materials as specified in Section III. New materials will be requisitioned from stock under the stock number and/or item description and shall conform to the appropriate specification. When not available from stock, materials may be purchased locally that conform as closely as possible to the standard material.

9-5. CLASSIFICATION

Refer to chapter 1 for serviceability classification of coats and overcoats.

9-6. REPAIR AND MAINTENANCE

Prior to repair operations, each item shall be inspected by qualified personnel to determine the amount of repair necessary. The following methods shall be observed as fully as skills, facilities, funds, and local conditions permit. The sequence of operations shall be determined by the repairing organization, unless otherwise prescribed.

- a. Inspection. Inspect all items to determine the amount of repairs needed and whether such repairs can be accomplished within the organization, or evacuate to direct support level of maintenance.
- b. Repair. Repairs to be accomplished by hand sewing at organizational maintenance are limited to replacing missing or damaged buttons and attaching loose belt loops. Replacement buttons will match the original buttons in color, design, and size of the type specified in Section III.
- c. Cleaning. Remove dirt, dust, and other foreign matter by brushing. Stains in wool coats and overcoats should be removed in accordance with table 9-4.
- d. Direct Support Maintenance.
 - (1) Preliminary examination and cleaning. Dirt, mud, dust, spots, stains, and other foreign matter shall be removed with a brush or by laundering. Mildew and rotten items shall be discarded. Seams shall be tested by grasping the item with both hands and pulling at right angles to the seam. Areas to be repaired shall be marked with crayon. Nonspecification and personnel marks shall be erased or obscured.
 - (2) Cleaning (dry-cleaning). Items that require dry-cleaning and/or mothproofing will be processed in Army dry-cleaning facilities in accordance with item label instructions. When such facilities are not available, items shall be dry-cleaned by contract with private industry in accordance with accepted commercial dry-cleaning practices.

9-6 REPAIR AND MAINTENANCE-Continued

Table 9-4. Procedures for Stain Removal

TYPE OF STAIN	PROCEDURE FOR WOOL FABRIC	PROCEDURE FOR SYNTHETIC FABRIC
Gravy	Rub stain with cold water; then place a pad or cloth underneath fabric to absorb stain, and rub stain with cleaning fluid. If any stain remains, dry the fabric and rub with a soap or synthetic detergent solution. Do not rub excessively as this may damage the finish of the garment.	Sponge with cold or lukewarm water. If grease spot remains, launder washable materials in a soap or synthetic detergent solution, using warm water. Do not rub material.
Food	Dampen stained area with water. Apply soap or synthetic detergent solution (with ammonia, if available), tamp with brush, and flush with water.	Same as procedure for gravy (above).
Milk	Same as procedure for food stain.	Same as procedure for gravy.
Fruit or fruit juices	Flush stained area with lukewarm water. Apply soap or synthetic detergent solution, tamp with brush, and flush out with water. (If available, apply lemon juice or vinegar and flush thoroughly with water).	Same as procedure for gravy.
Grease or oil	Scrape off top of stain, then saturate stained area with cleaning fluid, tamp with brush and flush out with cleaning fluid.	Scrape off top of stain. Launder washable materials in a soap or synthetic detergent solution, using warm water. Do not rub material.

9-6 REPAIR AND MAINTENANCE-Continued

Table 9-4. Procedures for Stain Removal-Continued

TYPE OF STAIN	PROCEDURE FOR WOOL FABRIC	PROCEDURE FOR SYNTHETIC FABRIC
Blood	Dampen area that is stained with water. Apply soap or synthetic detergent solution (with ammonia if available), tamp with brush, and flush with water.	Flush stained area with lukewarm or cold water, then using warm water, wash stain with a soap or synthetic detergent solution. If stain remains, sponge with hydrogen peroxide. (Do not use bleach on colored material).
Blood	Scrape off top of stain. Dampen stained area with water, apply soap or synthetic detergent solution (with ammonia if available), tamp with brush and flush with water.	Scrape off top of stain. Flush stain area with lukewarm or cold water, then, using warm water, wash stain with a soap or synthetic detergent solution. If stain remains, sponge with hydrogen peroxide, (Do not use bleach on colored material).

Note: Additional Stain Removal Introduction will be found in FM 10-300.

(3) Repair.

- (a) Stitching and restitching shall conform to V-T-276, V-T-301, and MIL-T-43548 in the following types of stitch, thread size, and stitches per inch required for repair (Table 9-5).

Table 9-5. Stitching Instruction

Service Coats, Men's

USE	STITCH TYPE	THREAD NEEDLE/BOBBIN	STITCHES PER INCH
General	301	50/3-50/3	10-14
Overedge	503 or 504	70/2-70/2	6-10
Bartack	--	50/3-50/3	28
Buttonholes (5/8 inch)	--	B-B	42-48
Buttonholes (1 Inch)	--	B-B	63-70
Buttons	101 or	30/3	14-16
	301 or	30/3-30/3	14-16
	hand	30/3	4-6

9-6 REPAIR AND MAINTENANCE-Continued

Table 9-5. *Stitching Instruction-Continued*
Coat All-Weather, Man's

USE	STITCH TYPE	THREAD NEEDLE/BOBBIN	STITCHES PER INCH
General	301	50/3-50/3	10-12
Overedge	502, 503, or 504	70/2-70/2	6-12
Safety Stitch	515, 516, or 519	50/3-70/2	10-12
Bartack	--	50/3-50/3	28
Buttonholes (1-1/8 inch)	--	30/3-50/3	70-74
Buttonholes (7/8 Inch)	--	30/3-50/3	50-54
Buttonholes (5/8 inch)	--	30/3-50/3	44-48
Buttonholes (1/2 inch)	--	30/3-50/3	36-40
Buttons	101 or	30/3	14-16
	301 or	30/3-30/3	14-16
	hand	30/3	4-6

- (b) Patching and darning. Repair rips and tears that will not be visible when garment is worn. Repair small rips and tears not more than 1/2-inch across their greatest dimension by drawing the edges together and darning with a zig-zag stitch. Repair holes, rips, and tears greater than 1/2 inch by patching when acceptable to appearance standards. Cut patch from material matching that being repaired and insert under the damaged area. Cut patch large enough to extend from 1/4 to 3/8 inch around the perimeter of the opening. Darn or patch areas in pockets, vent openings, or other areas that will not be visible when garment is worn.
- (c) Buttons. Replace missing, broken, or damaged buttons with matching ones (Sec III) Aline buttons with buttonholes.
- (d) Buttonholes. Fashion buttonholes of the eyelet-end square bar type over gimp to properly fit and move free over button. Repair buttonholes by reshaping the enlarged buttonhole before reworking and then pull it into shape by hand or machine. Stitch a small reinforcement patch to the underside of the garment and rework the buttonhole through the patch. Tack ends of buttonhole securely. Use thread and stitching listed in (a) above.
- (e) Pockets and Flaps. Repair or replace torn, missing, or defective pockets and flaps Restitch ripped seams on flaps and pockets. Darn small holes and tears when necessary; patch slightly larger holes if the darning and patching will not be visible when garment is worn.
- (f) Vents. Darn or patch holes, tears, and frays that will not be visible when the garment is worn.

9-6 REPAIR AND MAINTENANCE-Continued

- (g) Shoulder loops. Restitch or replace loose, missing, or defective shoulder loops. Whenever the outer facing of a shoulder loop shows unacceptable defects, reverse and place on opposite shoulder if possible, provided shade of the fabric matches. Fabricate replacement shoulder loops from cloth conforming to the basic material of the garment.
- (h) Lining. Repair holes, tears, or other defects in linings by darning or patching. Darn any small holes or tears before any patches are sewn on. Darn and cover holes at armholes with a patch of lining material in the shape of a sweat shield with the raw edges turned in and felled to armhole and lining.
- (l) Slide fastener. Replace missing or damaged slide fasteners of the type prescribed in Section III.
- (j) Hangers and button loops. Replace or resew missing or loose hanger loops with like material.
- (k) Buckles. Replace missing or damaged buckles with the type prescribed in Section III.

9-7. RESIZING

After cleaning and repairs have been accomplished, resize items according to sizes listed in the appropriate table (tables 9-1 through 9-3). When garments vary in size from original markings, obliterate old marking and mark proper size with indelible pencil or waterproof ink. When measurements do not correspond to a size listed, relabel to nearest breast and back-length size. For example, if the coat measures 22 inches in the half-breast and 29-13/16 inches in the back, mark in the coat label "size 40". Coats in good wearable condition should not be sent to the Property Disposal Officer because the back and breast measurements are off fractions of an inch.

9-8. WORKMANSHIP

All work shall be accomplished by personnel skilled in the particular trade applicable to their duties in the repair of the subject items. Patches will be tightly sewn and all reseaming will be secure and free of loose or broken thread. Buttons will be securely and properly attached. The finished item shall be complete, clean, well repaired, and free from all defects affecting its serviceability and appearance.

9-9. INSPECTION

The inspection or quality control unit is responsible for determining compliance with repair Instructions and requirements for classification. In-process inspection will be performed for quality of workmanship and correct application of repair procedures. The completed item will be inspected for serviceable condition and appearance to insure against return of substandard product to supply channels.

Section III. MATERIALS - Continued

(1) SMR CODE	(2) NATIONAL STOCK NUMBER	(3) DESCRIPTION	(4) UNIT OF ISSUE
		SERVICE COAT, MEN'S	
PAF	8305-01-103-6402	Cloth, Polyester and wool serge, 11.3 oz, Army Green 344, conform to Type III, Class 3 or MIL-C-823	YD
PAF	8305-00-063-2386	Cloth, Cotton Buckram Bleached, conform to Type II, Class 1 of CCC-C-438. Purchase locally.	
PAF	8305-01-008-3622	Cloth, Rayon, Lining, 3.7 oz, Green 45, Class 1, conform to MIL-C-368	YD
PAF	8315-01-064-8596	Braid, Tubular, Cotton/Rayon, Green 44, 1/8 to 3/16 inch wide, Type IX, Class 1, conform to MIL-B-371 Purchase locally	YD
PAF	8310-01-066-8280	Thread, Cotton-Covered, Polyester, Size 30, 2 ply, Green 66034, conform to MIL-T-43548	CE
PAF	8310-01-067-6514	Thread, Cotton-Covered, Polyester, Size 50, 2 ply, Green 66034, conform to MIL-T-43548	CE
PAF	8310-01-067-6512	Thread, Cotton-Covered, Polyester, Size 70, 2 ply, Green 66034, conform to MIL-T-43548	CE
PAF	8310-00-451-6178	Thread, Silk, Size B, 3 ply, Green 66034, conform to V-T-301	TU
PAF	8310-00-197-7769	Thread, Cotton, Size 40, 3 ply, Black 66043 conform to V-T-276	CE
PAF	8310-00-634-9821	Thread, Gimp, Green 66034, Size No.8, Type I, conform to V-T-280	SL
PAF	8455-00-899-0025	Buttons, Type I, Style 2, 36 line hopper back conform to MIL-B-3461	EA
PAF	8455-00-899-0024	Buttons, Type I, Style 2, 24 line hopper back, conform to MIL-B-3461	EA

Section III. MATERIALS - Continued

(1) SMR CODE	(2) NATIONAL STOCK NUMBER	(3) DESCRIPTION	(4) UNIT OF ISSUE
		COAT, ALL-WEATHER, MAN'S	
PAF	8305-01-067-8249	Cloth, Pile, Acrylic Fiber Pile, shade Black conform to Class 2, of MIL-C-43251	YD
PAF	8305-01-067-8250	Cloth, Taffeta, Nylon shade Black, conform to Type III of MIL-C-21852	YD
PAF	8305-01-067-8252	Cloth, Satin, Acetate or Rayon Face and Rayon or Cotton Back, shade Black, conform to Type I of MIL-C-43525	YD
PAF	8310-01-071-5896	Thread, Cotton-Covered Polyester, Size 30, 3 Ply, Black C.A. 66043, Type II, Class 3 of MIL-T-3530	CE
PAF	8310-01-071-5895	Thread, Cotton-Covered, Polyester, Size 50, 3 Ply, Black C A. 66043, Type II, Class 3 of MIL-T-3530	CE
PAF	8310-01-070-7684	Thread, Cotton-Covered, Polyester, Size 70, 3 Ply, Black C.A 66043, Water Repellant of MIL-T-3530	CE
PAF	8310-00-262-0097	Thread, Gimp, Cotton, Black, C.A. 66043, Size No. 8, Type I, conform to V-T-280	CE
PAF	8315-01-066-5860	Buttons, Type II, Class D, 40 line, shade Black 62001, conform to V-B-871	GR
PAF	8315-00-405-2268	Buttons, Type II, Class D, 30 line, shade Black 62001, conform to V-B-871	GR
PAF	8315-00-405-2270	Buttons, Type II, Class D, 24 line, shade Black 62001, conform to V-B-871	GR
PAF	8315-01-066-5861	Buttons, Type II, Class D, style 15, 18 line shade Black 62001, conform to V-B-871	GR
PAF	8315-01-064-8596	Braid, Textile, Tubular, shade Black, Type IX, Class 1, conform to MIL-B-371	YD
		Slide Fasteners, Black Shade Tape, Type IV, Style 1, Size L, with short tab pull and brass of aluminum chain, conform to V-F-106, Purchase Locally	EA

CHAPTER 10

MAINTENANCE OF COLD WEATHER CLOTHING, COAT, PARKA, AND TROUSERS

Section I. INTRODUCTION

10-1. SCOPE

This chapter prescribes the procedures and instructions for repair of the man's cold weather coat, trousers, and the extreme cold weather parka.

10-2. COMMODITY SPECIFICATIONS

a. Items.

SPECIFICATION	ITEM
MIL-C43455 MIL-P-43496 MIL-T-43497	Coat, Cold Weather, Field Parka, Extreme Cold Weather Trousers, Men's, Field

b. Components.

SPECIFICATION	ITEM
V-B-871	Button, Sewing Hole, and Button Staple (Plastic)
V-F-106	Fasteners, Slide, Interlocking
V-L-61	Laces, Footwear, Nylon
V-T-280	Thread, Cotton Gimp, Buttonhole
MIL-T-43548	Thread, Polyester, Cotton Covered
JJ-W-155	Webbing, Textile, Cotton, Elastic
CCC-C-438	Cloth, Buckram, Cotton
MIL-B-371	Braid, Textile, Cotton, Tubular
MIL-C-484	Cloth, Wind-Resistant, Oxford, Cotton, Quarpel Treated
MIL-B-543	Buckles, Tongueless and Web Strap
MIL-T-3530	Thread and Twine, Mildew Resistant or Water Repellent
MIL-C-3760	Cloth, Flannel, Wool and Cotton

10-2. COMMODITY SPECIFICATIONS-Continued

SPECIFICATION	ITEM
MIL-C-3924 MIL-F-10884 MIL-E-20652 MIL-F-21840 MIL-C-43191 MIL-C-43247 MIL-T-43303 MIL-T-43566	Cloth, Oxford, Cotton Warp and Nylon Filling, Quarpel Treated Fasteners, Snap Eyelets, Metallic, with Washers Fastener Tape, Hooks and Pile, Nylon Cloth, Wind Resistant Sateen, Cotton and Nylon Cloth, Knitted, Nylon, Tubular, Stretch-Type Cord, Elastic, Cotton Tape, Textile, Cotton, General Purpose, Natural or in Colors

c. Technical Publications. Publications not listed in chapter 1.

NUMBER	TITLE
DA PAM 738-750 FM 10-280	The Army Maintenance Management System Field Laundry, Bath and Clothing Exchange Operations

10-3. IDENTIFICATION AND DESCRIPTION

- a. Coat, Cold Weather, cotton and nylon, wind resistant sateen, MIL-C-43455, class 1, Army Shade OG107, (NSN's 8415-00-782-2933 through 8415-00-782-2945 and Class 2, Camouflage Printed NSN's 8415-01-099-7827 through 8415-01-099-7842). The man's cold weather coat is made of water repellent and wind resistant cotton and nylon sateen. It is a loose fitting, hip length coat with slide fastener front closure. Adjustable sleeve tabs are provided for wrist fit The coat has two bellows-type breast pockets and two Inside-hanging pockets on the lower front, all snap fastener closed Waist and hem drawcords are provided Buttons are provided on the inside facing of the front closure for attaching the coat liner (See figure 10-1)

10-3. IDENTIFICATION AND DESCRIPTION-Continued

- b. Trousers, Men's, cotton and nylon wind resistant sateen, Army Shade OG 107, MIL-T-43497, class 1, (NSN's 8405-00-782-2948 through 8405-00-782-2961) and Class 2, Camouflage Printed (NSN's 8415-01-099-7853 through 8415-01-099-7862). The men's cotton and nylon wind resistant sateen trousers have a slide fastener closure and a slide buckle waist adjustment. There are snap fastener closed front pockets and rear pockets and two cargo pockets with tie tapes Button tabs are provided in the waistband for attaching the trouser liners. (See figure 10-2)
- c. Parka, Extreme Cold Weather, w/out hood, cotton and nylon, Army shade 107, MIL-P-43496 (NSN's 8415-00-782-3216 through 3220). The olive green extreme cold weather parka is a single breasted outer garment made of water repellent cotton and nylon oxford cloth. It is slide fastener closed, and the sleeves have adjustable cuffs. There are two slit-type breast pockets with snap fastener closures. Waist and hem drawcords are provided Inside buttons and button tabs are provided for attaching the parka liner Buttonholes on the collar are provided for attaching the fur hood. (See figure 10-3.)

10-3. IDENTIFICATION AND DESCRIPTION-Continued

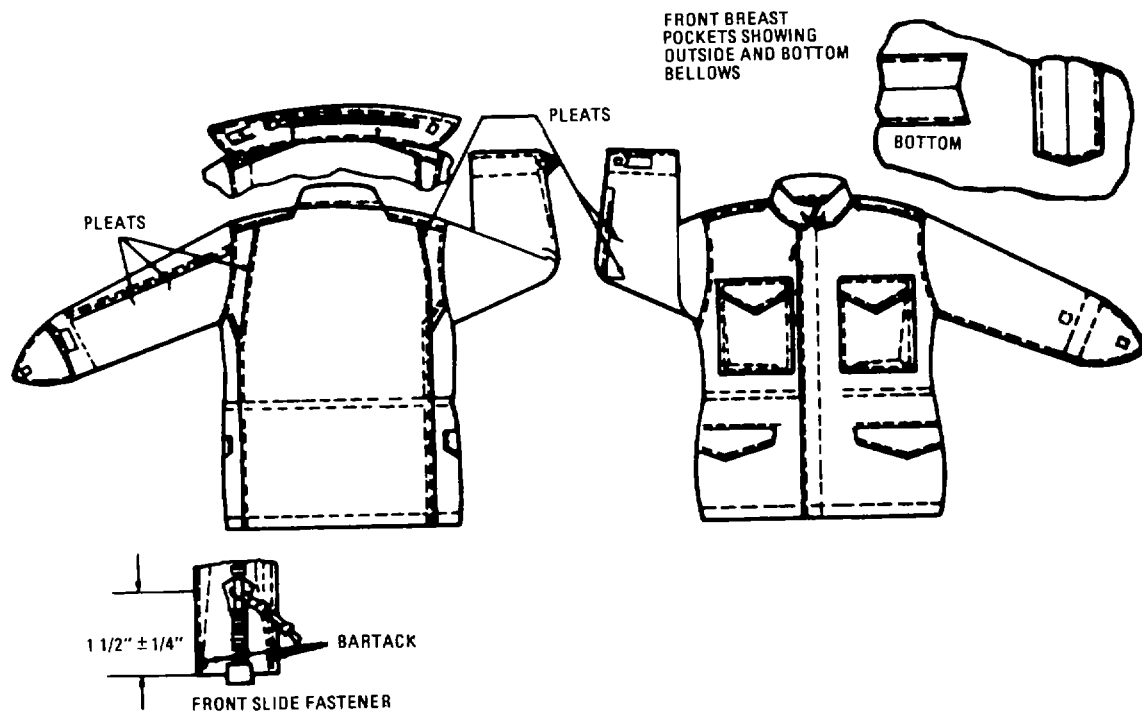

Figure 10-1. Cold weather coat.

10-3. IDENTIFICATION AND DESCRIPTION-Continued

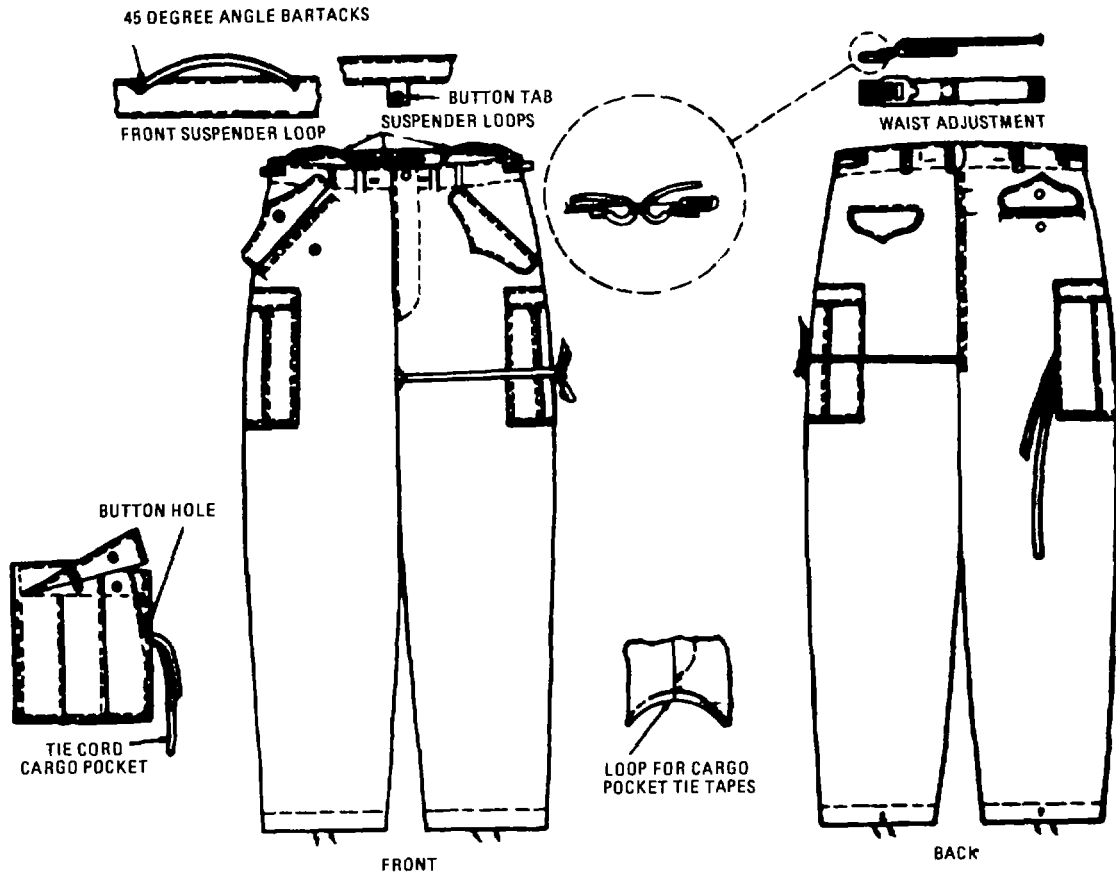

Figure 10-2. Men's trousers

10-3. IDENTIFICATION AND DESCRIPTION-Continued

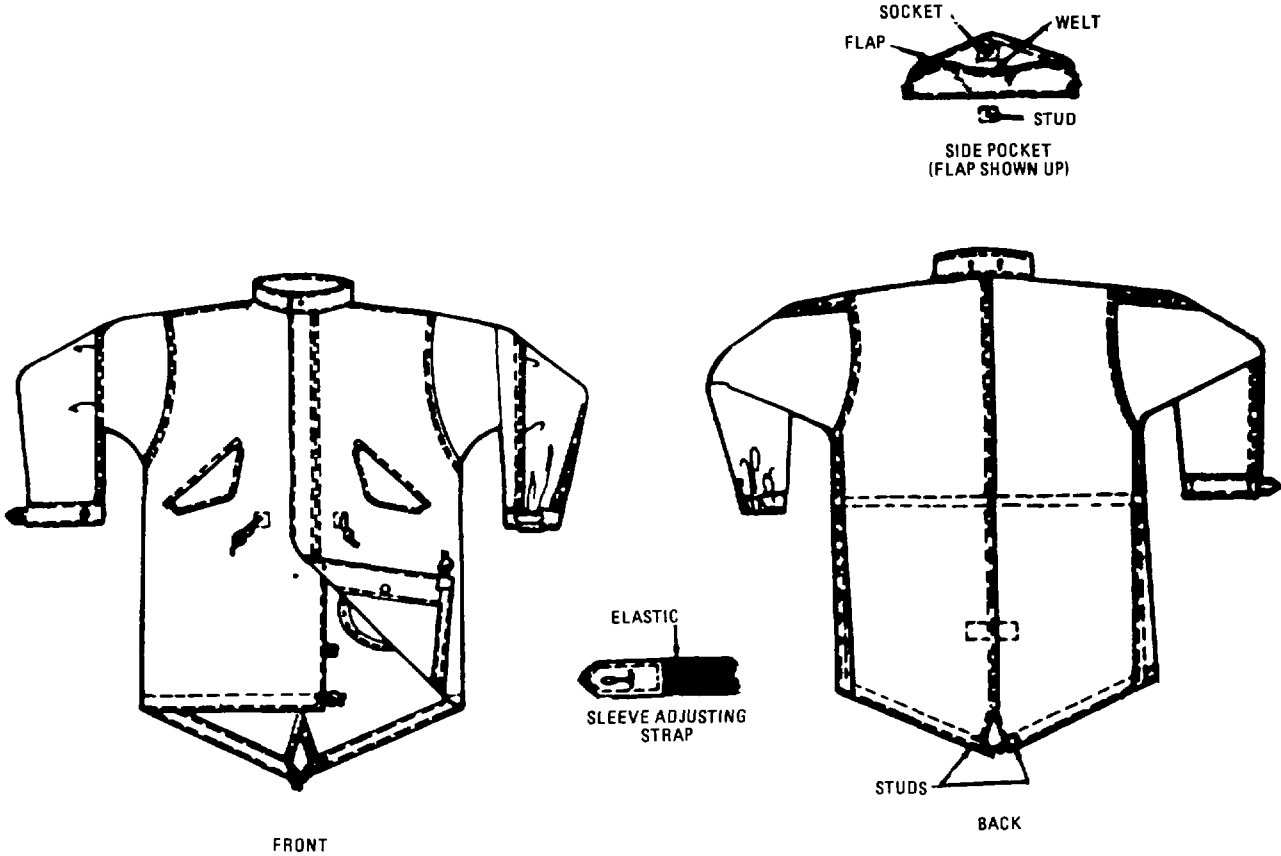

Figure 10-3. Extreme cold weather parka

Section II. REPAIR PROCEDURES

10-4 MATERIALS

Materials used in the repair of cold weather clothing shall be serviceable materials recovered from similar salvaged items, when authorized, or will be new materials as specified in section III. New materials will be requisitioned from stock under the stock number and/or Item description and shall conform to the appropriate specification. When not available from stock, the materials may be purchased locally that conform as closely as possible to the standard materials.

10-5. CLASSIFICATION

Refer to chapter 1 for serviceability classifications to be used for cold weather clothing.

10-6. REPAIR AND MAINTENANCE

Prior to repair operations, each Item shall be inspected by qualified personnel to determine the amount of repair necessary. Repairs will be made as fully as skills, facilities, funds, and local conditions permit. The sequence of operations shall be determined by the repairing organization, unless otherwise prescribed.

- a. Inspection. Inspect all items to determine the amount of repairs needed and whether such repairs can be accomplished within the organization, or evacuate to direct support level of maintenance.
- b. Cleaning. User will keep garments clean either by individual laundering in accordance with prescribed home laundry procedures or by use of installation laundry facilities.
- c. Organizational Repair. Repair to be accomplished at organizational level will be hand sewing of rips, tears, loose seams, and damaged buttonholes. Replacement buttons will match the original buttons in color, design, and size of the type specified in section III.
- d. Direct Support Maintenance.
 - (1) Preliminary examination and cleaning. Dirt, mud, dust, spots, stains, and other foreign matter will be removed with a brush or by laundering. Rotten items will be discarded. Seams will be tested by grasping the item with both hands and pulling at right angles to the seams. Areas to be repaired shall be marked with crayon. Non-specification and personal marks shall be erased or obliterated.
 - (2) Cleaning. Clothing will be processed in Army laundries in accordance with established cleaning practices as prescribed in FM 10-280. The coat, trousers, and parka are quarpel treated and must be thoroughly rinsed after cleaning to insure removal of cleaning compounds and reactivation of water repellent characteristics.

10-4. REPAIR AND MAINTENANCE

(3) Repair

- (a) Stitching and restitching. Use machine sewing whenever possible for all stitching and restitching. Backstitch or bartack all stitching at ends at least 1 inch (2.54 cm) to prevent raveling. Maintain proper thread tension to prevent loose stitching and to imbed the lock in the center of the material sewn. When type 401 stitch is used, place looper thread on the underside. The type of stitch, thread size, and stitches per inch are listed below.

USE	STITCH	NEEDLE/BOBBIN THREAD	STITCHES PER INCH
General	301 or 401	30/3 30/3	12-16
Buttonhole	--	30/3 30/3	52 per buttonhole
Button	101 or 301	30/3 -	14-16
Slide fastener	301	30/3 30/3	10-16
Bartack	--	50/3 50/3	28 per bartack

- (b) Patching and darning. Repair small holes and tears not exceeding 1/2 inch (1.27 cm) in diameter by darning. Patch holes, rips, tears, and areas worn thin which are greater than 1/2 Inch (1.27 cm) in any dimension. The patch will match as nearly as possible the material being repaired in type, quality, and color. Cut away the damaged area and turn edges under not less than 1/2 inch (1.27 cm) and not more than 1 inch (2.54 cm) around the perimeter of the opening, with not less than 3/8 inch (0.953 cm) turnunder of all edges except selvage edge. Pre-cut patches to provide symmetry. Inspect previously patched areas and repair if found defective. Cut away all mildew areas and darn, patch, or replace. Retack defective bartacks, using the original construction method. Repair or replace missing, loose, or defective gussets. Repair gussets with holes not exceeding 1/2 Inch (1.27 cm) by overlapping edges and hand sewing with an overcast or hidden stitch. When the lower half of the under sleeve is badly worn, apply patch to cover entire damaged area. Rip out the cuff stitching, tuck the lower edge of the patch inside, and restitch. Serge all frayed edges. Replace tabs and other missing parts or parts damaged beyond repair, using original construction method.
- (c) Buttons. Replace missing, damaged, or loose buttons with matching ones. Align buttons with buttonholes.
- (d) Slide fasteners. Replace damaged, missing, or malfunctioning slide fasteners with serviceable ones.
- (e) Snap fasteners. Replace missing, loose, or damaged snap fasteners. Darn or patch damaged area surrounding snap fastener sockets and studs prior to attaching snap fasteners.
- (f) Drawcords. Replace missing or defective drawcords in lengths to match original construction.

10-4. REPAIR AND MAINTENANCE-Continued

- (g) Eyelets. Replace missing, loose, badly split, and off-center eyelets. Darn enlarged eyelet holes with No. 30/3 thread. Punch holes receiving eyelets smaller than outside diameter of eyelet barrel so that barrel must be forced through the material.
- (h) Sleeve closures. Replace defective elastic webbing in sleeve adjusting straps. Replace defective buttonhole tabs.
- (i) Hangers. Replace defective or missing hanger loops. Construct hangers by folding a strip of cloth and double stitch with a covering stitch on the under side.
- (j) Cuffs. Repair or replace defective or missing cuffs with cloth of like material, size, and style. Fold cuff and seam side edges. Turn cuff and attach points by single stitching the edge of the underfold of the cuff to the underside of the sleeve. Turn edge of upperfold of cuff and single stitch to the upper side of sleeve, continuing the raise stitching across square end of seam.
- (k) Pocket flaps. Repair or replace torn, missing, or defective flaps. Restitch ripped seams or loose stitching.
- (l) Pockets.
 - 1. Breast pockets. Restitch loose or ripped pockets. Replace missing or defective pockets with ones fabricated of like material, size, and design of the original.
 - 2. Lower pockets. Repair or replace defective or missing pockets with new ones of like material, constructed of double thickness of cloth with the corners supported by a strip of 3/4-inch (1.91 cm) material. Turn in the raw edges of the facing and single stitch to end of double pocket pieces. Place welt piece and pocket flat on outside of pocket opening and sew through the coat, backstitch ends of stitching, and turn pocket and welt through opening and form a 1/2-inch (1.27 cm) welt. Bring end of pocket up and stitch together with upper edge of facing to pocket opening. Tack webbing strap to shoulder seam 1/2-inch (1.27 cm) from the neck and to the jacket side seam.
- (m) Binding and facing. Restitch defective stitching in binding and facing. Replace torn, frayed, or missing bindings and facings or such parts that have mildewed or rotted.

10-7. RESIZING

After cleaning and repair, resize garments according to sizes listed in the appropriate sizing table (tables 10-1, 10-2, and 10-3). When garments vary in size from original markings, obliterate old marking and mark proper size with indelible pencil or waterproof ink. When measurements do not correspond to the measurements listed, re-label to the next lower size.

Table 10-1. Finished measurements, Cold Weather Coats

	REGULAR (IN.)	SHORT (IN.)	X-SHORT (IN.)	LONG (IN.)	TOLERANCE (IN.)
1/2 Breast measurement¹					
X-small	20-3/4	20-3/4	20-3/4	20-3/4	• 3/4
Small	22-3/4	22-3/4	22-3/4	22-3/4	• 3/4
Medium	24-3/4	24-3/4	24-3/4	24-3/4	• 3/4
Large	26-3/4	26-3/4		26-3/4	• 3/4
X-large	28-3/4	28-3/4		28-3/4	• 3/4
Back-length²					
X-small	31	29-1/2	28	32-1/2	• 1
Small	31-1/2	30	28-1/2	33	• 1
Medium	32	30-1/2	29	33-1/2	• 1
Large	32-1/2	31		34	• 1
X-Large	33	31-1/2		34-1/2	• 1
Sleeve length³					
X-small	19-1/4	18-1/4	17-1/4	20-1/4	• 3/4
Small	19-1/4	18-1/4	17-1/4	20-1/4	• 3/4
Medium	19-1/4	18-1/4	17-1/4	20-1/4	• 3/4
Large	19-1/4	18-1/4		20-1/4	• 3/4
X-larae	19-1/4	18-1/4		20-1/4	• 3/4

¹ One-half breast measurement shall be measured at the base of the armhole from folded edge to folded edge, with front closed.

² The back length shall be measured along center back from undercollar seam to extreme bottom edge of coat.

³ The sleeve length shall be measured from base of armhole along forearm seam to bottom of sleeve.

10-7. RESIZING-Continued**Table 10-2. Finished Measurements, Men's Trousers**

SIZE	1/2 WAIST ¹
X-small	14-1/2
Small	16-1/2
Medium	18-1/2
Large	20-1/2
X-large	22-1/2
<i>Lengths</i>	<i>Inseams'</i>
Short	27
Regular	30
Long	33

¹ One-half waist measurement taken along top edge of waistband, with waistband buttoned, from folded edge to folded edge.

² Inseam taken from crotch seam to bottom edge of leg hem. The tolerance for waist measurements shall be + 3/4, -1/2 Inch and for inseams. . 3/4 inch.

Table 10-3. Finished Measurements, Extreme Cold Weather Parka

SIZE	HALF CHEST ¹	BACK LENGTH ²	SLEEVE LENGTH ³
	(Inches)	(Inches)	(Inches)
X-Small	25	41	25
Small	27	41-1/2	25-1/2
Medium	29	42	26
Large	31	42-1/2	26-1/2
X-large	33	43	27
Tolerance	+ 3/4	±1	+ 3/4

¹ The chest shall be measured at the base of the armholes, from folded edge to folded edge, with front closed.

² The back length shall be measured along center back from neck seam to extreme bottom edge of garment.

³ The sleeve shall be measured from top of sleeve to bottom of sleeve.

10-8. LABELING

Each garment will have a combination identification-size label and an instruction label, or a combination identification-size instruction label conforming to Type I of DDD-L-20 Repair or remark labels to provide required information. Replace labels which cannot be repaired by remarking with new ones located adjacent to or sewn over the old label.

- a. Instruction Label. Label information shall be printed in letters not less than 10-point and shall read as follows'

COAT, COLD WEATHER: FIELD

1. Wear as outer garment or as under-layer in cold dry climate
2. Wear button-in liner for added insulation.
3. Adjust closures and drawcords to ventilate; avoid overheating of body.
4. When hood is used, lower extension shall be worn over neck opening, preventing water entering opening.
5. Brush snow or frost from garments before entering heated shelters.
6. For fast drying, remove liner from coat.
7. Do not expose to high temperature of a stove.
8. Lubricate slide fasteners with wax.
9. For cleaning and restoring of water repellency, return to laundry for machine washing In accordance with established procedures for quarpel treated garments
10. Machine Washing: Use permanent Press Cycle. Wash in warm water using mild detergent.
11. Hand Washing: Wash in warm water using mild detergent. DO NOT WRING OR TWIST. Rinse in clean warm water.
12. DO NOT USE CHLORINE BLEACH OR STARCH.
13. Drying. Dry at low heat (do not exceed 130°F). After drying, tumble at room temperature for 10 minutes. Remove immediately from dryer To drip dry, remove from water and place on a rust-proof hanger.

DO NOT REMOVE THIS LABEL**TROUSERS, MEN'S, COTTON AND NYLON WIND RESISTANT SATEEN, M-65, OG107**

Wear as outer garment in cold-wet climate or as inner layer of cold-dry uniform.
Button In liner for extra warmth. Remove it when damp or wet and allow to dry.
Attach suspender hooks to waist loops.
Adjust waist by buckle straps.
Ventilate by loosening drawcords.

10.7 LABELING-Continued

Wear leg bottoms outside foot gear and secure drawcords.

Brush off snow and frost before entering heated shelter.

Avoid contact with heated stoves, open fires, or other high heat source; fabric may fuse.

Dry trousers and liner separately.

Lubricate slide fastener with lead pencil, graphite, or wax.

Wash by hand or machine, with slide fastener closed, in hot water with mild soap or detergent, rinse thoroughly and machine or drip dry.

PARKA, EXTREME COLD WEATHER

1. Wear as outer garment in cold-dry climate.
2. Button in liner for extra warmth. Remove it when damp or wet and allow to dry.
3. Button on fur ruffed hood for increased head protection.
4. Fasten drawstrings at waist and bottom for maximum warmth. Tighten sleeve cuffs by drawing elastic tabs tightly around wrists and buttoning tabs.
5. Tie the drawstrings around each thigh to provide greater freedom of movement and an additional water repellent surface to sit on. When bottom extension is not needed, turn it up on inside of parka and fasten with snap fasteners.
6. Loosen drawstrings, open zipper, and unbutton elastic tabs on sleeve cuffs to ventilate. AVOID overheating.
7. Brush off snow and frost before entering heated shelters.
8. Avoid contact with heated stoves, open fires, or other high heat sources; fabric may fuse.
9. Lubricate slide fastener with lead pencil, graphite or wax.
10. For cleaning and restoring of water repellency return to laundry for machine washing in accordance with established procedure for quarpel treated garments. The slide fastener shall be closed when laundered.

DO NOT REMOVE THIS LABEL

- b. Size Label. Label information shall be printed in letters not less than 10 point and shall read as follows-

(1) Men's coats.

Small-Short

8411-782-2935

COAT, COLD WEATHER, COTTON AND RAYON WIND RESISTANT SATEEN

CHEST: FROM 33 to 37 IN.

HEIGHT: UP TO 67 IN.

10-8. LABELING-Continued

Medium-Short

8415-782-2938

COAT, COLD WEATHER, COTTON AND RAYON WIND RESISTANT SATEEN

CHEST: FROM 37 to 41 IN.

HEIGHT: UP TO 67 IN.

Large-Short

8415-782-2938

COAT, COLD WEATHER, COTTON AND RAYON WIND RESISTANT SATEEN

CHEST: FROM 37 to 41 IN.

HEIGHT: UP TO 67 IN.

Large-Short

8415-782-2941

COAT, COLD WEATHER, COTTON AND RAYON WIND RESISTANT SATEEN

CHEST: FROM 41 to 45 IN.

HEIGHT: UP TO 67 IN

X-Small-Regular

8415-782-2933

COAT, COLD WEATHER, COTTON AND RAYON WIND RESISTANT SATEEN

CHEST: UP TO 33 INCHES

HEIGHT: FROM 67 to 71 IN

Small-Regular

8415-782-2936

COAT, COLD WEATHER, COTTON AND RAYON WIND RESISTANT SATEEN

CHEST: FROM 33 to 37 IN.

HEIGHT: FROM 67 to 71 IN.

Medium-Regular

8415-782-2939

COAT, COLD WEATHER, COTTON AND RAYON WIND RESISTANT SATEEN

CHEST: FROM 37 to 41 IN.

HEIGHT: FROM 67 to 71 IN.

Large-Regular

8415-782-2942

COAT, COLD WEATHER, COTTON AND RAYON WIND RESISTANT SATEEN

CHEST: FROM 41 to 45 IN.

HEIGHT: FROM 67 to 71 IN

10-7. LABELING-Continued

(1) Men's coats-Continued

X-Large-Regular

8415-782-2945

COAT, COLD WEATHER, COTTON AND RAYON WIND RESISTANT SATEEN

CHEST: FROM 45 IN. UPWARD

HEIGHT: FROM 67 to 71 IN.

Small-Long

8415-782-2937

COAT, COLD WEATHER, COTTON AND RAYON WIND RESISTANT SATEEN

CHEST: FROM 33 to 37 IN.

HEIGHT: FROM 71 IN UPWARD

Medium-Long

8415-782-2940

COAT, COLD WEATHER, COTTON AND RAYON WIND RESISTANT SATEEN

CHEST: FROM 37 to 41 IN.

HEIGHT: FROM 71 IN. UPWARD

Large-Long

8415-782-2943

COAT, COLD WEATHER, COTTON AND RAYON WIND RESISTANT SATEEN

CHEST: FROM 41 to 45 IN

HEIGHT: FROM 71 IN UPWARD

(a) Coat, Cold Weather, Field, Class 1 (OG 107)

X-Small X-Short

Height: Up to 63 in.
 Chest Mn: Up to 33 In.
 Chest Wn: Up to 36 In.
 Stock No. 8415-01-062-0677
 NATO Size: 5060/7484

Small X-Short

Height: Up to 63 in.
 Chest Mn: From 33 to 37 In.
 Chest Wn: From 36 to 40 in
 Stock No. 8415-01-062-0079
 NATO Size: 5060/8494

X-Small Short

Height: From 63 to 67 in.
 Chest Mn: Up to 33 In.
 Chest Wn: Up to 36 In
 Stock No. 8415-01-027-6032
 NATO Size: 6070/7484

Small Short

Height: From 63 to 67 In.
 Chest Mn: From 33 to 37 in
 Chest Wn: From 36 to 40 in
 Stock No. 8415-00-782-2935
 NATO Size: 6070/8494

10-8. LABELING-Continued

(a) Coat, Cold Weather, Field, Class 1 (OG 107)

Medium X-Short

Height: Up to 63 in.
 Chest Mn: From 37 to 41 in.
 Chest Wn: From 40 to 44 In.
 Stock No. 8415-01-062-0678
 NATO Size: 5060/9404

Medium Short

Height: From 63 to 67 in.
 Chest Mn: From 37 to 41 in.
 Chest Wn: From 40 to 44 in
 Stock No. 8415-00-782-2938
 NATO Size: 6070/8494

Large Short

Height: Up to 67 in.
 Chest: From 41 to 45 In.
 Stock No. 8415-00-782-2941
 NATO Size: 6070/0414

X-Large Short

Height: Up to 67 in.
 Chest: From 45 in. and up
 Stock No. N/A
 NATO Size: 6070/1424

X-Small Regular

Height: From 67 to 71 in.
 Chest Mn: Up to 33 in.
 Chest Wn: Up to 36 in.
 Stock No. 8415-00-782-2933
 NATO Size: 7080/7484

X-Small Long

Height: From 71 in. up
 Chest Mn: Up to 33 in
 Chest Wn: Up to 36 In.
 Stock No. 8415-01-066-5578
 NATO Size: 8090/7484

Small Regular

Height: From 67 to 71 in.
 Chest Mn: From 33 to 37
 Chest Wn: From 36 to 40 in.
 Stock No. 8415-00-782-2936
 NATO Size: 7080/8494

Small Long

Height: From 71 in. and up
 Chest Mn: From 33 to 37 in.
 Chest Wn: From 36 to 40 in
 Stock No. 8415-00-782-2937
 NATO Size: 8090/9404

Medium Regular

Height : From 67 to 71 in.
 Chest Mn: From 37 to 41 in.
 Chest Wn: From 40 to 44 in.
 Stock No. 8415-00-782-2939
 NATO Size: 7080/9404

Medium Long

Height: From 71 In and up
 Chest Mn: From 37 to 41
 Chest Wn: From 40 to 44 in.
 Stock No. 8415-00-782-2940
 NATO Size: 8090/9404

10-8. LABELING-Continued

(a) Coat, Cold Weather, Class 1 (OG 107)-Continued

Large Regular

Height: From 67 to 71 in.
 Chest: From 41 to 45 in.
 Stock No. 8415-00-782-2942
 NATO Size: 7080/0414

Large Long

Height: 71 in. and up
 Chest: From 41 to 45 in.
 Stock No. 8415-00-782-2943
 NATO Size: 8090/0414

X-Large Regular

Height: From 67 to 71 in.
 Chest: From 45 in. and up
 Stock No. 8415-00-782-2945
 NATO Size: 7080/1424

(b) Coat, Cold Weather, Class 2 (Camouflage Printed)

X-Small X-Short

Height: Up to 63 in.
 Chest Mn: Up to 33 in.
 Chest Wn: Up to 36 in.
 Stock No. 8415-01-099-7825
 NATO Size: 5060-7484

X-Small Short

Height: From 63 to 67 in.
 Chest Mn: Up to 33 in.
 Chest Wn: Up to 36 in.
 Stock No. 8415-01-099-7826
 NATO Size: 6070/7484

Small X-Short

Height: Up to 63 in.
 Chest Mn: From 33 to 37 in.
 Chest Wn: From 36 to 40 in.
 Stock No. 8415-01-099-7829
 NATO Size: 5060/8494

Small Short

Height: From 63 to 67 in.
 Chest Mn: From 33 to 37 in.
 Chest Wn: From 36 to 40 in.
 Stock No. 8415-01-099-7830
 NATO Size: 6070/8494

Medium X-Short

Height: Up to 63 in.
 Chest Mn: From 37 to 41 in.
 Chest Wn: From 40 to 44 in.
 Stock No. 8415-01-099-7833
 NATO Size: 5060/9404

Medium Short

Height: From 63 to 67 in.
 Chest Mn: From 37 to 41 in.
 Chest Wn: From 40 to 44 in.
 Stock No. 8415-01-099-7834
 NATO Size: 6070/9404

Large Short

Height: Up to 67 in.
 Chest: From 41 to 45 in.
 Stock No. 8415-01-099-7837
 NATO Size: 6070/0414

10-8. LABELING-Continued

(b) Coat, Cold Weather, Class 2 (Camouflage Printed)-Continued

X-Large Short

Height: Up to 67 in
 Chest: From 45 In. and up
 Stock No. 8415-01-099-7840
 NATO Size: 6070/1424

X-Small Regular

Height: From 67 to 71 In.
 Chest Mn: Up to 33 in
 Chest Wn: Up to 36 in.
 Stock No. 8415-01-099-7827
 NATO Size: 7080/7484

X-Small Long

Height: From 71 in up
 Chest Mn: Up to 33 In.
 Chest Wn: Up to 36 In.
 Stock No. 8415-01-099-7828
 NATO Size: 8090/7484

Small Regular

Height: From 67 to 71 in
 Chest Mn: From 33 to 37 in.
 Chest Wn: From 36 to 40 in.
 Stock No. 8415-01-099-7831
 NATO Size: 7080/8494

Small Long

Height: From 71 in and up
 Chest Mn: From 33 to 37 In
 Chest Wn: From 36 to 40 in.
 Stock No. 8415-01-099-7832
 NATO Size: 8090/8494

Medium Regular

Height: From 67 to 71 In
 Chest Mn: From 37 to 41 in.
 Chest Wn: From 40 to 44 in.
 Stock No. 8415-01-099-7835
 NATO Size: 7080/9404

Medium Long

Height: From 71 in. and up
 Chest Mn: From 37 to 41 In
 Chest Wn: From 40 to 44 In.
 Stock No. 8415-01-099-7836
 NATO Size: 8090/9404

Large Regular

Height: From 67 to 71 in.
 Chest: From 41 to 45 in.
 Stock No. 8415-01-099-7838
 NATO Size: 7080/0141

Large Long

Height: From 71 In and up
 Chest: From 41 to 45 In.
 Stock No. 8415-01-099-7839
 NATO Size: 8090/0414

X-Large Regular

Height: From 67 to 71 In.
 Chest: From 45 in and up
 Stock No. 8415-01-099-7841
 NATO Size: 7080/1424

X-Large Long

Height: From 71 In. and up
 Chest: From 45 in and up
 Stock No. 8415-01-099-7842
 NATO Size: 8090/1424

10-8. LABELING-Continued

(2) Men's trousers.

Short-Small

8405-782-2950

TROUSERS, MEN'S COTTON-NYLON WIND RESISTANT SATEEN, OG107

WAIST: FROM 27 to 31 IN

INSEAM: UP to 29-1/2 IN.

Short-Medium

8405-782-2953

TROUSERS, MEN'S: COTTON-NYLON WIND RESISTANT SATEEN, OG107

WAIST: FROM 31 to 35 IN.

INSEAM: UP to 29-1/2 IN

Regular-X-Small

8405-782-2948

TROUSERS, MEN'S. COTTON-NYLON WIND RESISTANT SATEEN, OG107

WAIST: BELOW 27 IN.

INSEAM: 29-1/2 to 32-1/2 IN.

Regular-Small

8405-782-2951

TROUSERS, MEN'S' COTTON-NYLON WIND RESISTANT SATEEN, OG107

WAIST: FROM 27 to 31 IN

INSEAM: 29-1/2 to 32-1/2 IN

Regular-Medium

8405-782-2954

TROUSERS, MEN'S: COTTON-NYLON WIND RESISTANT SATEEN, OS107

WAIST: FROM 31 to 35 IN

INSEAM: 29-1/2 to 32-1/2 IN.

Regular-Large

8405-782-2957

TROUSERS, MEN'S. COTTON-NYLON WIND RESISTANT SATEEN, OG107

WAIST: FROM 35 to 39 IN

INSEAM: 29-1/2 to 32-1/2 IN

Regular-X-Large

8405-782-2960

TROUSERS, MEN'S' COTTON-NYLON WIND RESISTANT SATEEN, OG107

WAIST: FROM 39 to 43 IN.

INSEAM: 29-1/2 to 32-1/2 IN

10-8. LABELING-Continued

(2) Men's trousers-Continued

Long-Small

8405-782-2952

TROUSERS, MEN'S: COTTON-NYLON WIND RESISTANT SATEEN, OG107
 WAIST: FROM 27 to 31 IN
 INSEAM: OVER 32-1/2 IN.

Long-Medium

8405-782-2955

TROUSERS, MEN'S: COTTON-NYLON WIND RESISTANT SATEEN, OG107
 WAIST: FROM 31 to 35 IN.
 INSEAM: OVER 32-1/2 IN.

Long-Large

8405-782-2958

TROUSERS, MEN'S' COTTON-NYLON WIND RESISTANT SATEEN, OG107
 WAIST: FROM 35 to 29 IN.
 INSEAM: OVER 32-1/2 IN

Long-X-Large

8405-782-2961

TROUSERS, MEN'S: COTTON-NYLON WIND RESISTANT SATEEN, OG107
 WAIST: FROM 39 to 43 IN
 INSEAM: OVER 32-1/2 IN.

(a) Trousers, Cold Weather, Class 1 (OG 107)

X-Small Short

Waist: Below 27 in.
 Inseam: Up to 29-1/2 In
 Stock No. N/A
 NATO Size: 6777/5869

X-Small Regular

Waist: Below 27 in.
 Inseam: 29-1/2 to 32-1/2 In.
 Stock No. 8415-00-782-2948
 NATO Size: 7583-5869

Small Short

Waist: From 27 to 31 in
 Inseam: Up to 29-1/2 In.
 Stock No.. 8415-00-782-2950
 NATO Size: 6775/6979

Small Regular

Waist: From 27 to 31 In.
 Inseam: 29-1/2 to 32-1/2
 Stock No. 8415-00-782-2951
 NATO Size: 7583/6979

10-8. LABELING-Continued

(a) Trousers, Cold Weather, Class 1 (OG 107)

Medium Short

Waist: From 31 to 35 In.
 Inseam: Up to 29-1/2 In.
 Stock No. 8415-00-782-2953
 NATO Size: 6775/7989

Large Short

Waist: From 35 to 39 In.
 Inseam: Up to 29-1/2 in
 Stock No. N/A
 NATO Size: 6775/8999

X-Large Short

Waist: From 39 to 43 in.
 Inseam: Up to 29-1/2 in.
 Stock No.
 NATO Size: 6775/9909

X-Small Long

Waist: Below 27 in.
 Inseam: Over 32-1/2 in.
 Stock No. N/A
 NATO Size: 8390/5869

Small Long

Waist: From 27 to 31 in.
 Inseam: Over 32-1/2 in.
 Stock No. 8415-00-782-2952
 NATO Size: 8390/6979

Medium Long

Waist: From 31 to 35 in
 Inseam: Over 32-1/2 in.
 Stock No. 8415-00-782-2955
 NATO Size: 8390/7989

Large Long

Waist: From 35 to 39 In.
 Inseam: Over 32-1/2 in.
 Stock No. 8415-00-782-2958
 NATO Size: 8390/8999

Medium Regular

Waist: From 31 to 35 in.
 Inseam: 29-1/2 to 32-1/2 In.
 Stock No. 8415-00-782-2954
 NATO Size: 7583/7989

Large Regular

Waist: From 35 to 39 in.
 Inseam: 29-1/2 to 32-1/2 in.
 Stock No. 8415-00-782-2957
 NATO Size: 7583/8999

X-Large Regular

Waist: From 39 to 43 In
 Inseam: 29-1/2 to 32-1/2 in.
 Stock No. 8415-00-782-2960
 NATO Size: 7583/9909

10-8. LABELING-Continued

(a) Trousers, Cold Weather, Class 1 (OG 107)-Continued

X-Large Long

Waist: From 39 to 43 in
 Inseam: Over 32-1/2 In.
 Stock No. 8415-00-782-2961
 NATO Size: 8390/9909

(b) Trousers, Cold Weather, Class 2 (Camouflage Printed)

X-Small Short

Waist: Below 27 in.
 Inseam: Up to 29-1/2 in
 Stock No. N/A
 NATO Size: 6775/5869

Small Short

Waist: From 27 to 31 in.
 Inseam: Up to 29-1/2 in.
 Stock No. 8415-01-099-7854
 NATO Size: 6775/6979

Medium Short

Waist: From 31 to 35 in.
 Inseam: Up to 29-1/2 in.
 Stock No. 8415-01-099-7857
 NATO Size: 6775/7989

X-Small Regular

Waist': Below 27 in.
 Inseam: 29-1/2 to 32-1/2 in
 Stock No. 8415-01-099-7853
 NATO Size: 7583/5869

Small Regular

Waist: From 27 to 30 in
 Inseam: 29-1/2 to 32-1/2 in
 Stock No. 8415-01-099-7855
 NATO Size: 7583/6979

Medium Regular

Waist: From 31 to 35 In.
 Inseam: From 29-1/2 to 32-1/2 in.
 Stock No. 8415-01-099-7858
 NATO Size: 7583/7989

Large Regular

Waist: From 35 to 39 In.
 Inseam: 29-1/2 to 32-1/2 In
 Stock No. 8415-01-099-7860
 NATO Size: 7583/8999

X-Large Regular

Waist: From 39 to 43 In.
 Inseam: 29-1/2 to 32-1/2 In.
 Stock No. 8415-01-100-0977
 NATO Size: 7583/9909

10-8. LABELING-Continued

(b) Trousers, Cold Weather, Class 2 (Camouflage Printed)-Continued

Small Long

Waist: From 27 to 31 in.
 Inseam: Over 32-1/2 in.
 Stock No. 8415-01-099-7856
 NATO Size: 8390/6979

Medium Long

Waist: From 31 to 35 in.
 Inseam: Over 32-1/2 in.
 Stock No. 8415-01-099-7859
 NATO Size: 8390/7989

Large Long

Waist: From 35 to 39 in
 Inseam: Over 32-1/2 in.
 Stock No. 8415-01-099-7861
 NATO Size: 8390/8999

X-Large Long

Waist: From 39 to 43 in.
 Inseam: Over 32-1/2 in.
 Stock No. 8415-01-099-7862
 NATO Size: 8390/9909

(3) Extreme cold weather parka.

Regular-X-Small

8415-782-3219

PARKA, EXTREME COLD WEATHER, MAN'S COTTON-NYLON-OXFORD, OG107,
 W/OUT HOOD
 CHEST: UP to 33 IN

Regular-Small

8415-782-3217

PARKA, EXTREME COLD WEATHER, MAN'S COTTON-NYLON-OXFORD, OG107,
 W/OUT HOOD
 CHEST: FROM 33 to 37 IN

Regular Medium

8415-782-3218

PARKA, EXTREME COLD WEATHER, MAN'S COTTON-NYLON-OXFORD, OG107,
 W/OUT HOOD
 CHEST FROM 37 to 41 In.

10-8. LABELING-Continued

(3) Extreme cold weather parka-Continued

Regular-Large

8415-782-3219

PARKA, EXTREME COLD WEATHER, MAN'S COTTON-NYLON-OXFORD, OG107,
 W/OUT HOOD
 CHEST: FROM 41 to 45 IN.

Regular-X-Large

8415-782-3220

PARKA, EXTREME COLD WEATHER, MAN'S COTTON-NYLON-OXFORD, OG107,
 W/OUT HOOD
 CHEST: FROM 45 IN. UPWARD

(a) Parka, Extreme Cold Weather (OG 107)

X-Small

Chest: Up to 33 in.
 Stock No. 8415-00-782-3216
 NATO Size: 7080/7484

Small

Chest: From 33 to 37 In.
 Stock No. 8415-00-782-3217
 NATO Size: 7080/8494

Medium

Chest: From 37 to 41 In.
 Stock No. 8415-00-782-3218
 NATO Size: 7080/9404

Large

Chest: From 41 to 45 in.
 Stock No. 8415-00-782-3219
 NATO Size: 7080/0414

X-Large

Chest: From 45 inches and Up
 Stock No. 8415-00-782-3220
 NATO Size: 7080/1424

10-9. WORKMANSHIP

All work shall be accomplished by personnel skilled in the particular trade applicable to their duties. Patches will be tightly sewn and all reseaming will be secure and free of loose or broken threads Hardware and buttons will be securely and properly attached. The finished garment shall be complete, clean, well repaired, and free from all defects affecting its serviceability and appearance.

10-10. INSPECTION

The inspection or quality control unit is responsible for determining compliance with repair Instructions and requirements for classification. In-process Inspections will be performed for quality of workmanship and correct application of repair procedures. The completed item will be inspected for serviceable condition and appearance to insure against return of substandard product to supply channels

Section III. MATERIALS

(1) SMR CODE	(2) FEDERAL STOCK NUMBER	(3) DESCRIPTION	(4) UNIT OF ISSUE	USED ON
PAF	8305-00458-0132	CLOTH, WIND RESISTANT, SATEEN 9 oz, olive green shade 107, Quarpel water repellent	YD	Coat and trousers
PAF	8305-00-901-2991	CLOTH, OXFORD, Cotton warp and nylon filling, 5.8 oz, olive green shade 107, Quarpel water repellent	YD	Parka
PAF	8305-00-198-8180	CLOTH, WOOL AND COTTON FLANNE L, 12 oz, olive drab No 35, MIL-C-3760	YD	Parka
PAF		CLOTH, COTTON, BUCKRAM Type I, class 1, CCC-C-438	YD	Coat, Parka
PAF	8310-00-262-0094	THREAD, COTTON GIMP, olive drab 66022-S1	SL	Coat, Trousers, Parka
PAF	8310-01-091-4032	Thread, Cotton Covered Rayon or Polyester, Ticket No.30/3, Olive Drab S-1 conforming to MIL-T-43548	CE	Coat, Trousers, Parka
PAF	8310-01-066-0973	Thread, Cotton Covered Rayon or Polyester, Ticket No.50/3, Olive Drab S-1 conforming to MIL-T-43548 and water repellent treated in accordance with Type II classes 2 and 3 of MIL-T-3550.	CE	Coat, Trousers, Parka
PAF	8305-00-281-8016	CORD, ELASTIC, olive green, 3/16 in dia. MIL-C-43303	YD	Coat, Parka
PAF	8315-00-297-1553	BRAID, TEXTILE, olive green shade 107, 6/32 in dia., MIL-B-371.	YD	Coat, Parka

Section III. MATERIALS - Continued

(1) SMR CODE	(2) FEDERAL STOCK NUMBER	(3) DESCRIPTION	(4) UNIT OF ISSUE	USED ON
PAF	8315-00-267-3125	BRAID, TEXTILE, olive green shade 107, 4/32 in dia., MIL-B-371	YD	Trousers
PAF	8315-00-262-3376	TAPE, TEXTILE, 1 In olive drab shade 7, MI L-T-43566	YD	Coat
PAF	8315-00-253-6277	TAPE, TEXTILE, 1-1/8 in., olive drab shade 7, MI L-T-43566	YD	Parka
PAF	8305-00-260-4604	WEBBING, TEXTILE, 5/8 In., olive drab shade 7, MI L-W-530	YD	Trousers
PAF	8305-00-260-1732	WEBBING, TEXTILE, 1 in, olive drab shade 7, MI L-W-530	YD	Trousers
PAF	8305-00-263-3638	WEBBING, TEXTILE, 1-1/2 in., olive drab shade 7, Fed-JJ-W-155	YD	Parka
F		LACING, TEXTILE, olive green shade 106, V-L-61. Source of supply, cannibalize		Trousers
PAF	8315-00-106-5973	FASTENER TAPE, HOOK, 1 In., olive green, MI L-F-21840	YD	Coat
PAF	8315-00-899-0029	BUTTON, SEWING HOLE, olive green, style 26/4, Fed-V-B-871	GR	Coat, Trousers, Parka
O		BUTTON, SEWING HOLE, olive green, type II, class D, style 20 or 21, 45 line, Fed-V-B-871, available from: American Trim Products Putnam, CT 06260 P/N 800-845-8158 Koppers U.S. Plastic & Chemical Company Putnam, CT 06260 P/N 800-243-1842 Scovill 500 5th Avenue New York, NY 10110 P/N 212-398-6220	EA	Parka

Section III. MATERIALS - Continued

(1) SMR CODE	(2) FEDERAL STOCK NUMBER	(3) DESCRIPTION	(4) UNIT OF ISSUE	USED ON
PAF	5325-00-292-5340	FASTENER, SNAP, brass, enamel finish, stud and eyelet, MIL-F-10884	SE	Coat, Trousers, Parka
PAF	5340-00-820-7838	BUCKLE, TONGUELESS, 2 bar, style 3, 5/8 In., MI L-H-9890	EA	Trousers
PAF	5325-00-221-1516	EYELET, STYLE A, style A or B, MIL-E-20652	HD	Coat, Parka
PAF	5310-00-209-1767	WASHER, STYLE A, size 4094 MIL-E-20652	EA	Coat, Parka
PAF	5325-01-265-6207	FASTENER, SLIDE, Type 4	EA	Coat, Cold Weather
PAF	5325-01-071-1329	FASTENER, SLIDE, Type 1	EA	Coat Collar, Cold Weather

CHAPTER 11

MAINTENANCE OF ROCKET FUEL HANDLERS' PROTECTIVE CLOTHING, TOXICOLOGICAL AGENTS PROTECTIVE CLOTHING, AND EXPLOSIVE HANDLERS' COVERALLS

Section I. INTRODUCTION

11.1. SCOPE

This chapter prescribes the procedures and instructions for repair of the Rocket Fuel Handlers', Toxicological Agents', and Explosive Handlers' Protective Clothing

11-2. COMMODITY SPECIFICATIONS

a. Items.

SPECIFICATION	ITEM
M I L-F-12224	Footwear Covers, Toxicological Agents', Protective, M-1' Olive drab 7
FED SPEC ZZ-B-530	Boots, Knee, Rubber: black, Non-Skid
MIL-H-12225	Hood, Gas Mask, Toxicological Agents' Army Shade olive green 107
MIL-C-2181	Coveralls, Toxicological Agents' Army shade olive drab 7
M I L-A-2334	Apron, Toxicological Agents'. Olive drab
MIL-C-14610	Coveralls, Explosive Handlers': Tinted neutral grey tone
MIL-C-43082	Coveralls, Rocket Fuel Handlers': Limited protection
MIL-C-43063	Coveralls, Rocket Fuel Handlers' Cotton airplane cloth
MIL-H-43088	Hood, Rocket Fuel Handlers': Black color
MIL-H-43079	Hood, Rocket Fuel Handlers': Black color

11-2. COMMODITY SPECIFICATIONS-Continued

b. Components.

SPECIFICATION	ITEM
JAN-C-517	Cloth, Coated, Cotton Print, White
M I L-C-1 164	Cloth, Cotton, Terry
MIL-W-530	Tape, Textile, Cotton, Natural
FED SPEC V-T-276	Thread, Cotton
MIL-F-10884	Fastener, Snap, Brass, Bronze Finish
AN 227-1 1B-12B	Fastener, Snap, Brass, Enamel Finish
FED SPEC DDD-T-86	Tape, Textile, Cotton, Green
M I L-W-530	Webbing, Textile, Cotton
MIL-B-543	Buckle, Brass
MIL-B-543	Buckle, Steel
MIL-B-371	Braid, Textile, Cotton
MIL-C-12189	Cloth, Cotton, Butyl Coated
MIL-C-342	Tape, Textile, Cotton
MS51927-1	Buckle, Brass
MIL-L-10028	Keeper Slide, Plastic
M I L-C-3133	Rubber Strip, Cellular
FED SPEC V-T-280	Thread, Cotton Gimp
FED SPEC JJ-W-155	Webbing, Textile, Elastic, Cotton
MIL-B-2288	Buckle, Steel
MIL-B-286	Button, Tack, Steel
	Eye, Hook, Belt Clasp
MIL-V-F-106	Fastener, Slide, Interlocking
MIL-F-10884	Fastener, Snap, Brass
AN 227-8B-9B	Fastener, Snap, Brass
	Grommet, Metallic, Brass
	Hook, Belt Clasp
M I L-L-3851	Loop, Slide, Brass
M I L-B-286	Tack, Button, Steel
FED SPEC V-B-871	Button, Sewing Hole
MIL-L-10028	Keeper, Slide, Plastic
MIL-S-10926A	Suspenders, Trousers
M I L-T-3530	Thread, Cotton
JAN-C-517	Cloth, Coated, Cotton Print
	Cloth, Cotton, Sateen
	Cloth, Coated, Cotton, Resin Modified
MIL-R-41837	Repair Kit, Toxicological Agents' Protective Clothing Butyl Rubber Coated
	Rubber Coated
MIL-R-14545	Repair Kit, Cold Weather Insulated Boot, Pneumatic Mattress
MIL-R-43120	Repair Kit, Rocket Fuel Handlers' Clothing, Butyl Rubber Coated

11-2. COMMODITY SPECIFICATIONS-Continued

c Technical Publications. Publications not listed in chapter 1.

NUMBER	TITLE
TM 3-220	Chemical, Biological and Radiological Decontamination.
TM 3-303	Impregnating Set, Clothing, Field, M3' Impregnating Outfit, Clothing, Field, M1: Kit, Testing, Impregnating-In-Clothing, M1
TM 9-2865	Instruction Guide: Repair of Slide Fasteners
FM 10-16	General Fabric Repair
TM 10-277	Chemical, Toxicological and Missile Fuel Handlers' Protective Clothing

11-3. IDENTIFICATION AND DESCRIPTION

a. Clothing, Protective, Rocket Fuel Handlers' Ensemble (Full Protection).

(1) Coveralls, rocket fuel handlers' (fig 11-1).

NSN	SIZES	SPECIFICATIONS
8415-00-725-3627	Small	MIL-C-43063
8415-00-725-3629	Large	MIL-C-43063
8415-00-725-3630	X-Large	MIL-C-43063
8415-00-725-3631	XX-Large	MIL-C-43063

The full protection coveralls (fig. 11-1) are made of either cotton airplane or nylon twill cloth with an impermeable resin modified butyl rubber coating and are issued in sizes small, medium, large, x-large, and xx-large. The coveralls have a front slide fastener closure with a Pullman-type snap closure over the slide fastener to assure complete protection. Each sleeve has a tapered plastic cone insert and a wristlet which rolls down over the gauntlet of the protective glove after the glove is in place. Each leg is equipped with elastic straps with snap fasteners which permit the cuffs to be securely closed around and over the protective boots.

(2) Hood, rocket fuel handlers', butyl-coated airplane cloth, black color (fig. 11-1)

NSN	SPECIFICATIONS
8415-00-753-3050	MIL-H-43088

11-3. IDENTIFICATION AND DESCRIPTION-Continued

The rocket fuel handlers' hood is made of cotton airplane cloth or nylon with an Impermeable resin modified butyl-rubber coating. The hood is issued in one size only. It consists of two tie tapes per eyepiece, a snout with a tie tape, and adjustable shoulder strap with snap fasteners.

- (3) Boot, knee, rubber, black, non-skid (figure 11-1).

NSN	SIZES	SPECIFICATION
8430-00-262-8252	5	FED. SPEC. ZZ-B-530
8430-00-262-8253	6	FED. SPEC. ZZ-B-530
8430-00-262-8254	7	FED. SPEC. ZZ-B-530
8430-00-262-8255	8	FED. SPEC. ZZ-B-530
8430-00-262-8256	9	FED. SPEC. ZZ-B-530
8430-00-262-8257	10	FED. SPEC. ZZ-B-530
8430-00-262-8258	11	FED. SPEC. ZZ-B-530
8430-00-262-8259	12	FED. SPEC. ZZ-B-530
8430-00-262-8260	13	FED. SPEC. ZZ-B-530
8430-00-262-8261	14	FED. SPEC. ZZ-B-530
8430-00-262-8278	15	FED. SPEC. ZZ-B-530

The boots are made of plain butyl rubber and can not withstand the effects of oxidizers and fuels. However, they are sufficiently thick to withstand some penetration. The boots are issued in sizes 5 through 15.

- b. Clothing, Protective, Rocket Fuel Handlers' Ensemble (Limited Protection)

- (1) Coveralls, rocket fuel handlers' (fig. 11-2).

NSN	SIZES	SPECIFICATION
8415-00-753-6208	Medium	MIL-C-43082
8415-00-753-6209	Large	MIL-C-43082

The coveralls are made of cotton airplane cloth or nylon with an impermeable resin modified butyl rubber coating and are issued in sizes medium and large. The sleeves are fitted with tapered plastic cones and wristlets to provide an airtight fit for the gray gloves. The coveralls are constructed with an open back and legs. The coveralls are fitted to the wearer and secured by use of the snap fasteners at the neckband, a snap fastener on the elastic strap at the middle of the back, and the elastic straps at the crotch and the legs.

- (2) Hood, rocket fuel handlers' (fig. 11-2)

11-3. IDENTIFICATION AND DESCRIPTION-Continued

NSN	CLASS	SPECIFICATION
8415-00-753-6211	1	MIL-H-43079
8415-00-753-6210	2	MIL-H-43079

The rocket fuel handler's hood is made of either cotton airplane or nylon twill cloth with an impermeable resin modified butyl rubber coating.

(3) Knee boot. The knee boot for the limited protection ensemble is the same as the boot in a(3) above.

c. Clothing, Protective, Toxicological Agents' Ensemble

(1) Coveralls, toxicological agents' (fig. 11-3).

NSN	SIZE	SPECIFICATION
8415-00-099-6962	Small	MIL-C-2181
8415-00-099-6968	Medium	MI L-C-2181
8415-00-099-6970	Large	MIL-C-2181
8415-00-099-2535	X-Large	MIL-C-2181

The coveralls are made of either cotton airplane or nylon twill cloth with an impermeable butyl rubber coating and are issued in sizes small, medium, large and x-large.

The coveralls are constructed with the gusset and a keeper, and a slide fastener which is covered by a cover flap. There are two collar adjusting straps. The sleeves have double cuffs and snap fasteners. The coveralls have an adjustable belt and the leg cuffs have an elastic strap with snap fasteners.

(2) Hood, gas mask, toxicological agents' protective (fig. 11-3)

NSN	SPECIFICATION
8415-00-261-6690	MIL-H-12225

The protective gas mask hood is made of cotton or nylon coated on both sides with butyl rubber and is issued in one size only. It is designed for semipermanent mounting on a protective mask (hoseless type) or hose type mask so that the combination can be used as a positive pressure leakproof unit. The hood has three adjustable openings, with attached tie tapes, one for each mask eyepiece and the snout. Its lower portion rests on the wearer's shoulders as a shawl. Sewed seams are covered by butyl-rubbercoated tape. There is an inner neckpiece and an outer neckpiece which falls over the collar of the protective coveralls. The hood is provided with three small loops to which the hood cooling cover is tied. The hood outer neckpiece is held in place on the wearer's shoulders by two adjustable straps which pass under the arms and are secured in front by snap fasteners. A draw cord is provided on the inner neckpiece to adjust the fitting of the hood at the neck.

11-3. IDENTIFICATION AND DESCRIPTION-Continued

(3) Footwear cover, toxicological agents' protective (fig. 11-3).

NSN	SIZES	SPECIFICATION
8430-00-262-5295	Small	MIL-F-12224
8430-00-262-5297	Medium	MI L-F-12224
8430-00-262-5296	Large	MI L-F-12224

The toxicological agents protective footwear is made of either cotton airplane or nylon twill cloth and an impermeable butyl rubber coating and is issued in sizes small, medium and large. The sole is made of cotton or nylon duck.

Located at the bottom of each boot cover are two 3/4 inch (1.9 cm) wide tie tapes for securing the cover over the boot, and on the leg of each boot cover are two 3/4 inch (1.9 cm) wide tie tapes for securing the cover over the leg of the suit.

(4) Apron, toxicological agents' protective(fig. 11-4).

NSN	SIZES	SPECIFICATION
8415-00-281-7813	Small	MIL-A-2334
8415-00-281-7814	Medium	MIL-A-2334
8415-00-281-7815	Large	MIL-A-2334
8415-00-281-7812	X-Small	MIL-A-2334
8415-00-281-7816	X-Large	MIL-A-23S-

The toxicological agents' protective apron (fig. 11-4) is made of butyl rubber coated airplane cloth or nylon and is issued in sizes X-small through X-large.

All sewed seams are cemented and taped to prevent leakage through needle holes. The apron is equipped with a neck strap at the top-rear and the tie straps at the middle-rear, the sleeves have adjusting straps for securing the sleeves over the gauntlets of the gloves.

d. Coveralls, Explosive Handlers' (fig. 11-5).

NSN	SIZE	SPECIFICATION
8415-00-280-2455	X-Small (32 and 34)	MIL-C-14610
8415-00-279-8719	Small (36 and 38)	MIL-C-14610
8415-00-279-8720	Medium (40 and 42)	MIL-C-14610
8415-00-279-8721	Large (44 and 46)	MIL-C-14610
8415-00-279-8722	X-Large (48 and 50)	MIL-C-14610

The explosive handlers' coveralls are made of fire-resistant, nonstatic, natural or tinted neutral grey-tone color cotton sateen cloth, with a button front closure and a lattice-laced pocket located on the right hip. The coveralls are issued in sizes X-small through X-large.

11-3. IDENTIFICATION AND DESCRIPTION-Continued

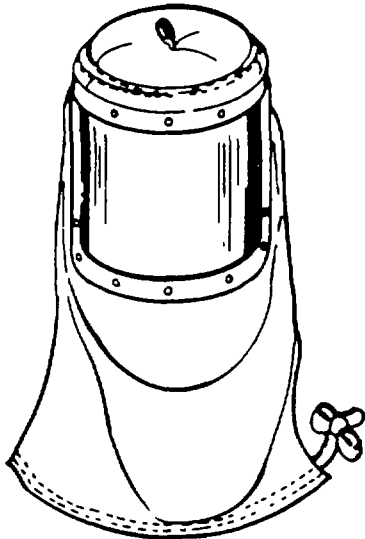

HOOD

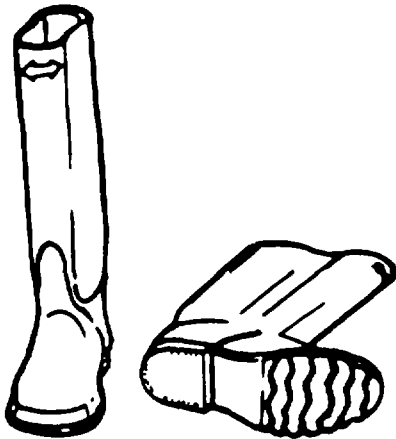

KNEE BOOTS

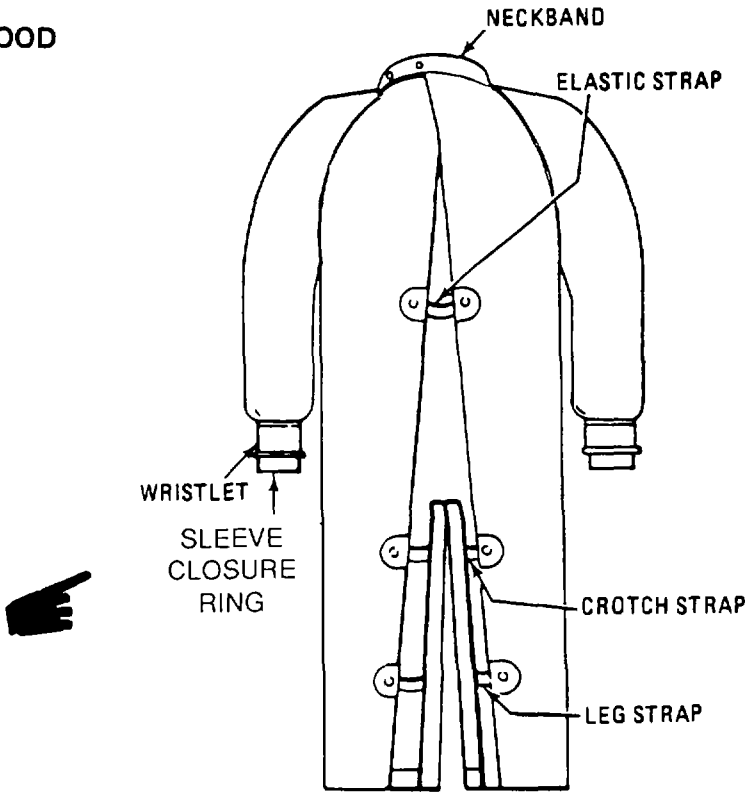

COVERALLS

Figure 11-1. Rocket Fuel Handler's Full Protection Clothing

11-3. IDENTIFICATION AND DESCRIPTION-Continued

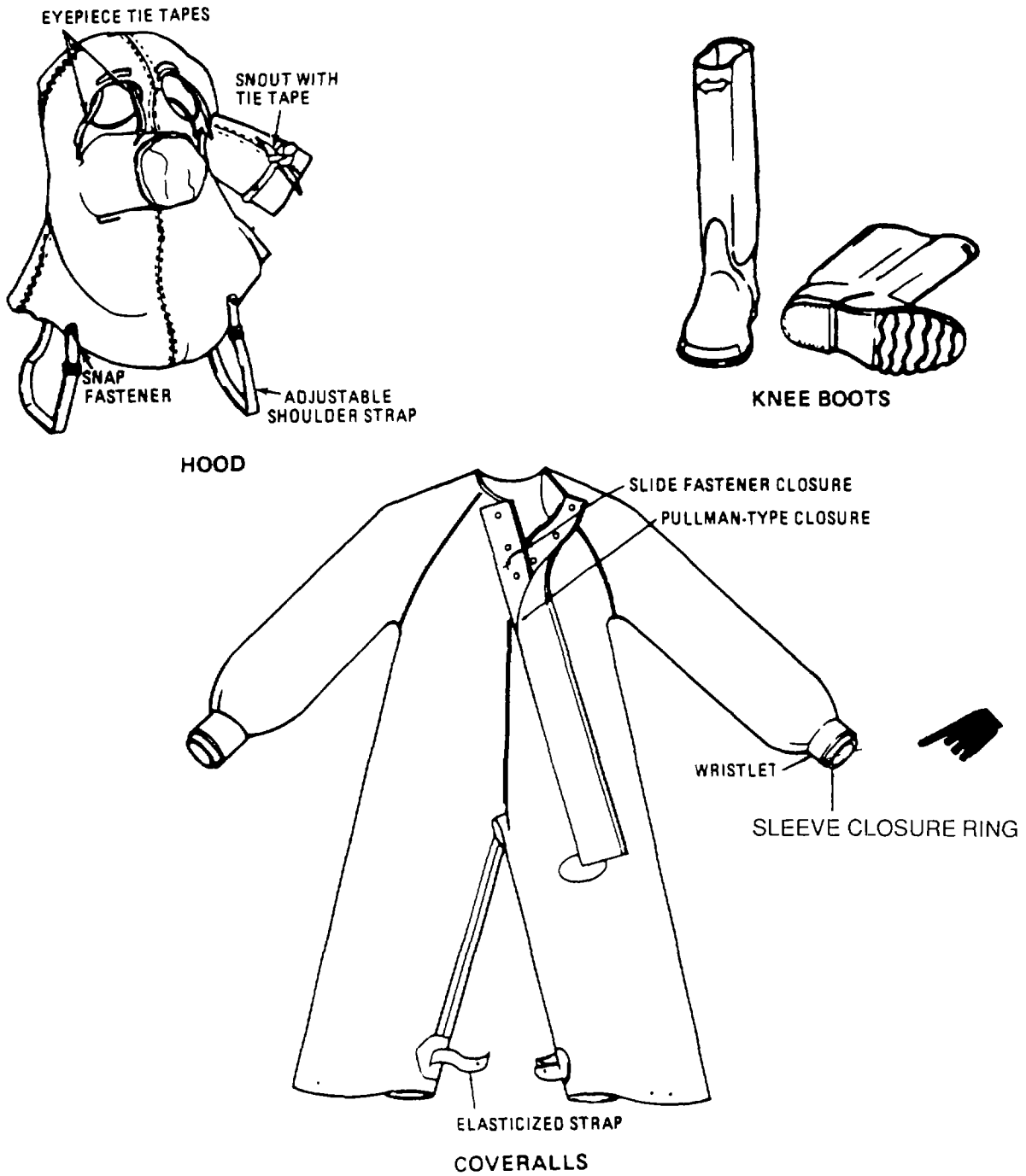

Figure 11-2. Rocket Fuel Handler's Limited Protection Clothing

11-3. IDENTIFICATION AND DESCRIPTION-Continued

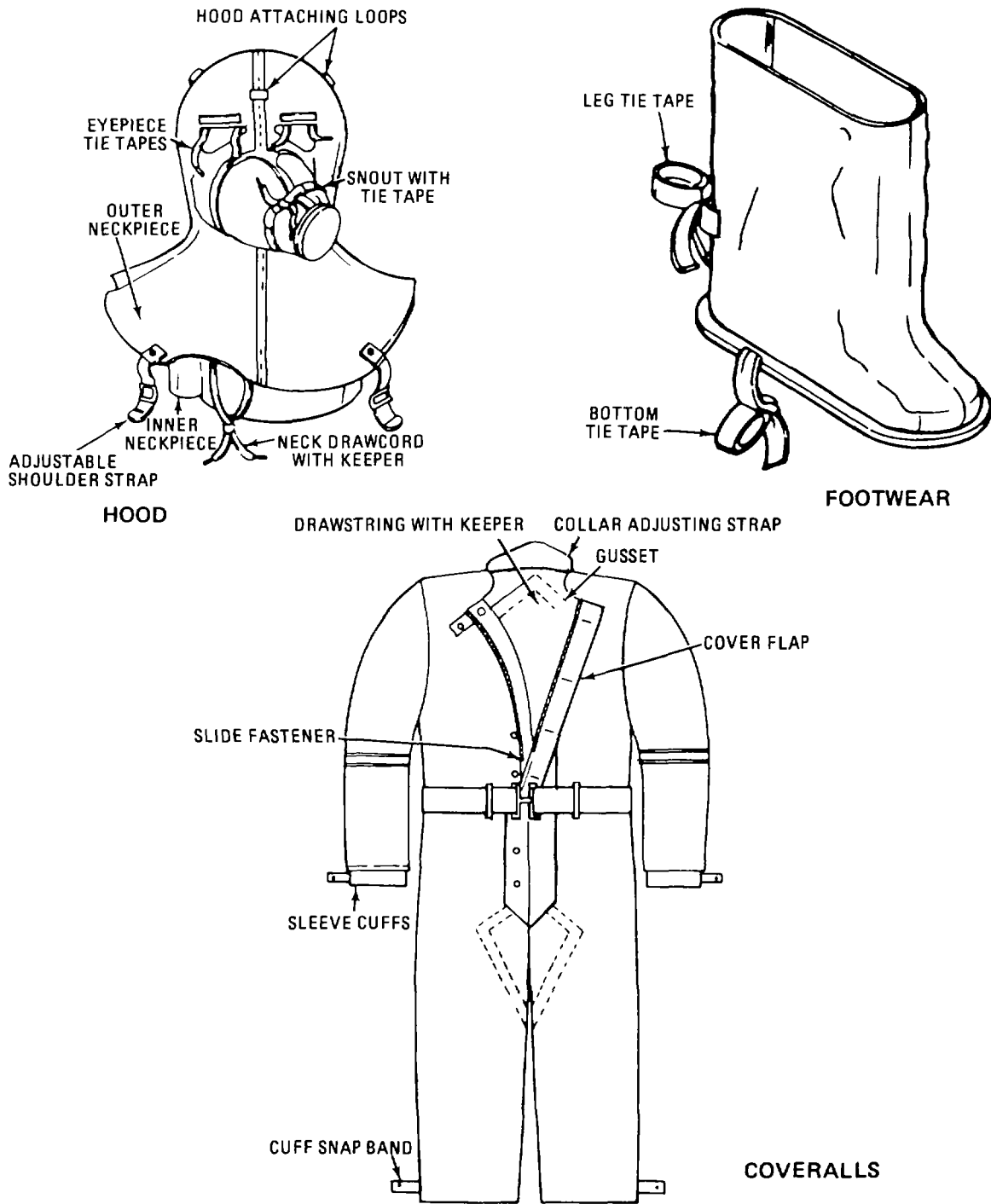

Figure 11-3 . Toxicological Agent's Protection Clothing

11-3. IDENTIFICATION AND DESCRIPTION-Continued

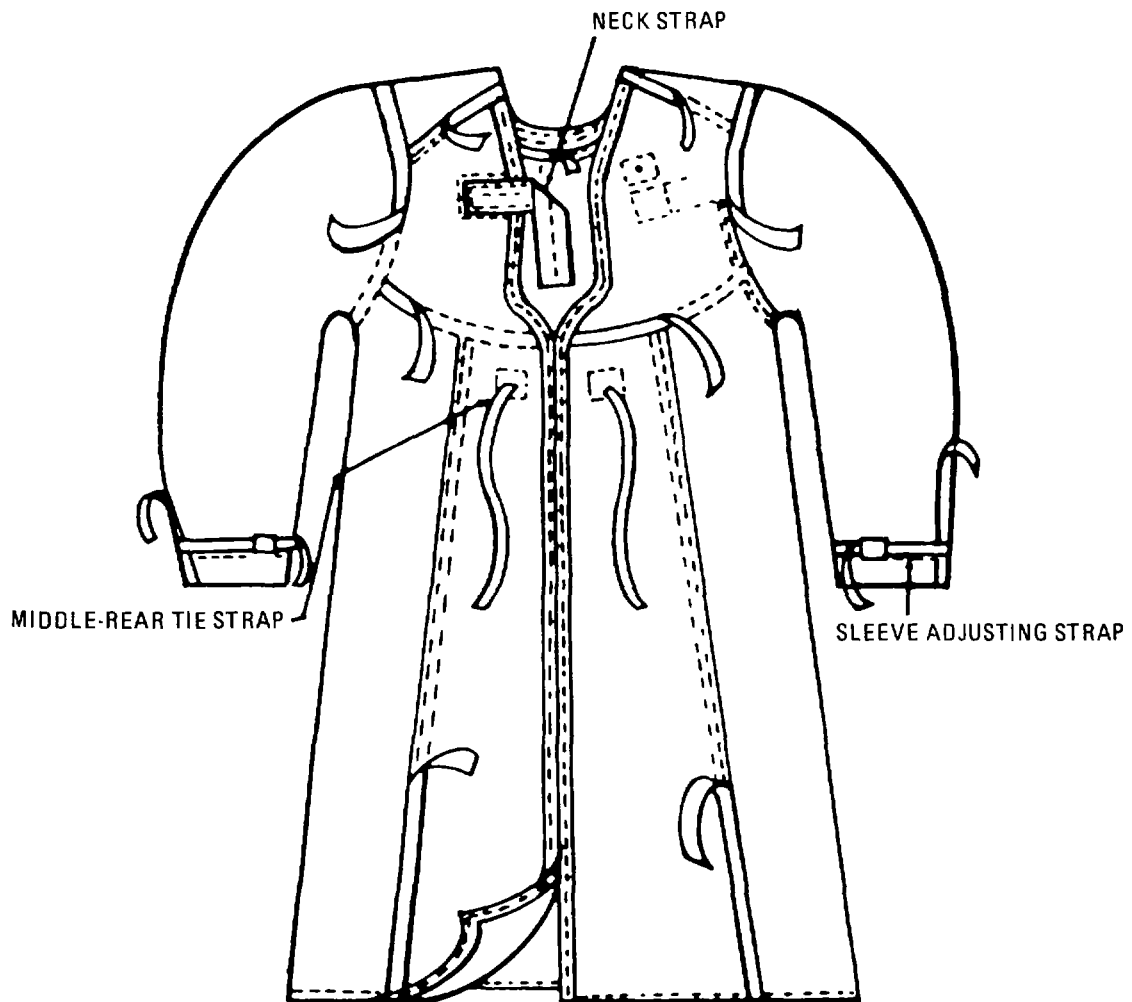

Figure 11-4 . Toxicological Agent's Protective Apron .

11-3. IDENTIFICATION AND DESCRIPTION-Continued

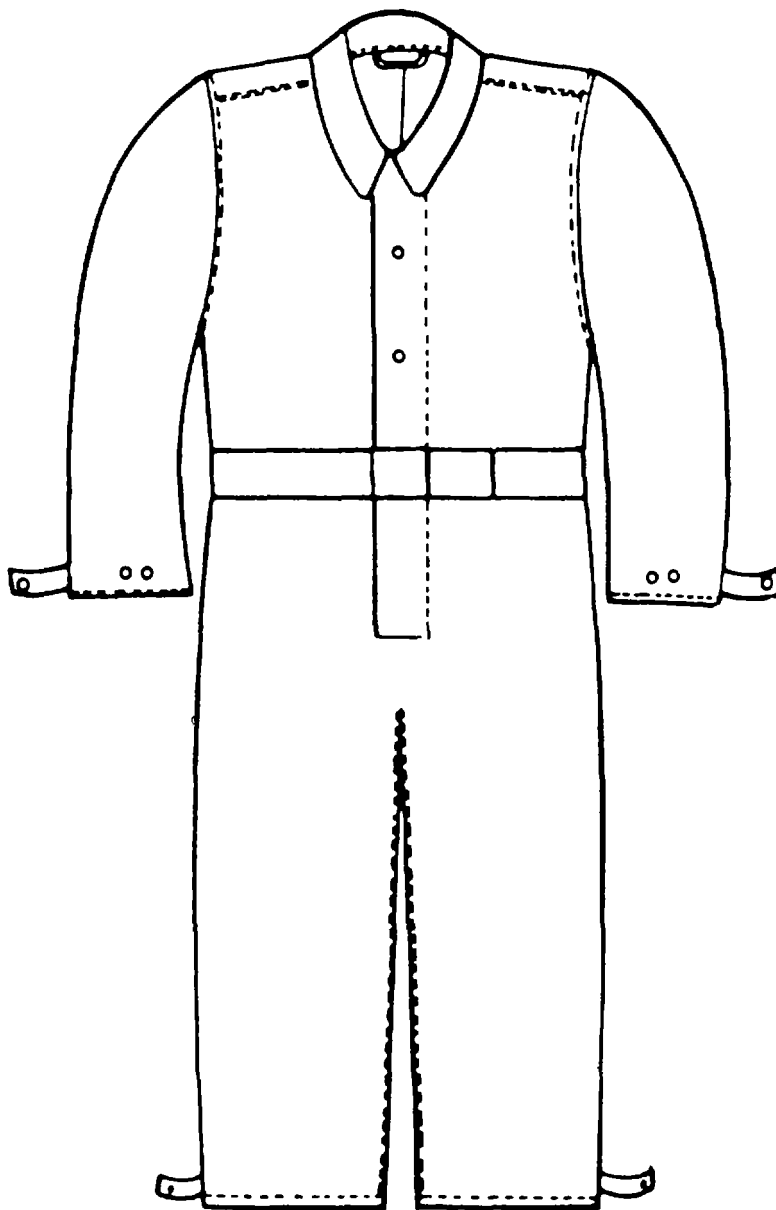

Figure 11-5 . Explosive Handlers' Coveralls

Section II. REPAIR PROCEDURES

11-4. MATERIALS

Materials used in the repair of coveralls, hoods, and suits shall be serviceable materials recovered from similar salvaged items when authorized, or will be new materials as specified in Section III. New materials will be requisitioned from stock number and or Item description and shall conform to the appropriate specification. When not available from stock, materials may be purchased locally that conform as closely as possible to the standard material.

11-5. CLASSIFICATION

Refer to chapter 1 for serviceability classification of the items which compose the protective clothing ensembles.

11-6. REPAIR AND MAINTENANCE

Prior to repair operations, each item shall be inspected by qualified personnel to determine the amount of repair necessary. The following methods shall be observed as fully as skills, facilities, funds, and local conditions permit. The sequence of operations shall be determined by repairing organization, unless otherwise prescribed.

- a. Inspection. Inspect all items to determine the amount of repairs needed and whether such repairs can be accomplished within the organization or evacuate to direct support level of maintenance.
- b. Repair. Repair to be accomplished at organizational maintenance is limited to hand sewing and to the application of patches issued with the impermeable clothing repair kit (Sec. III)
- c. Refer to TM 3-220 for cleaning and decontamination of protective clothing ensembles
- d. Direct Support Maintenance.
 - (1) Rocket fuel handlers' protective clothing.
 - (a) General
 1. This paragraph prescribes the cleaning, the inspection, and the repairs authorized to be performed on the rocket fuel handlers' protective clothing at the direct support level.
 2. Cleaning and repair will be performed by personnel skilled in the particular trade applicable to their duties in the maintenance of subject items. Finished items will be complete, satisfactorily repaired, and free of all defects affecting serviceability and appearance.

11-6. REPAIR AND MAINTENANCE-Continued

(b) Coveralls (full and limited-protection).

1. Cleaning. Refer to TM 3-220 for the cleaning and decontamination of rocket fuel handlers' protective coveralls.
2. Inspection.
 - (a) Inspect the fabric for holes, cuts, rips, or exposed base fabric.
 - (b) Inspect the strapping for proper adhesion to the fabric, blistering or air bubbles between the strapping and the fabric, and exposed stitching
 - (c) Inspect the sleeve closure rings for cracks, blistering, scratching, and loose or missing threads Make sure the wristlet is not torn or damaged
 - (d) Inspect the slide fastener for damaged scoops, broken or disconnected slider, missing thong, self-sealing, and ease of operation.
 - (e) Inspect for missing or nonfunctioning snap fasteners, alinement of male and female portions, and corrosion or tarnish
3. Repair.
 - (a) Patching. Patch a hole 1/4 Inch (0.6 cm) in diameter or a tear 2 inches (5.1 cm) in length by use of the rocket fuel handlers' impermeable clothing repair kit. A hole that exceeds 1/4 inch (0.6 cm) or a tear that exceeds 2 inches (5.1 cm) but does not exceed 3 inches (7 6 cm) will be patched as follows:
 - (1) Cut a patch from the bulk material of sufficient size to extend 1 inch on all sides of the rip or hole
 - (2) Clean and roughen the patching material and the garment with an abrasive strip.
 - (3) Apply a coating of cement to the patch and the garment, and allow the cemented areas to become tacky to the touch.
 - (4) Place the patch on the garment to cover the damaged area, and roll or press the patch firmly in place.
 - (5) After the patch sets, apply protective coating to both sides of the patched area, and allow it to harden.
 - (6) Apply a light coat of powdered talc to both sides of the patched area to prevent it from adhering to other portions of the garment. The maximum number of patches authorized on the coveralls is three per section.
 - (7) Patching on both sides is achieved by turning the item inside out and repeating steps 1 through 4.

11-6. REPAIR AND MAINTENANCE-Continued

(b) Replacement of tie tapes.

- (1) Remove the stitching that secures the tie tapes to the garment, and remove the tie tapes.
- 2) Measure an undamaged tie tape (to include folds and turn-unders) and cut a length from the elastic webbing bulk stock
- (3) Cut pieces of textile webbing, as required, for reinforcements where snap fasteners are to be installed.
- (4) Single-stitch reinforcements to tie tapes, backstitching at ends of thread.
- (5) Install new snap fasteners ((c) below) on the tie tapes where necessary
- (6) Position newly fabricated tie tape on the garment, and single-X-bosstitch the tape to the garment
- (7) If the stitching goes through the garment at a critical area, cement a patch over the stitching, or patches, and allow to set
- (8) Apply protective coating over the stitching, or patch, on the inside of the garment, and allow to set. Sprinkle powdered talc on the sealer to prevent adhesion to other parts of the garment

(c) Replacement of snap fasteners.

- (1) Place the garment on a hard surface with the barrel of the snap fastener down
- (2) With the material held firmly in place, ream out the flanged end of the snap fastener barrel with a drill, and separate the fastener halves.
- (3) Patch or darn the material from which the snap fastener was removed in order to strengthen the material.
- (4) Use a hole punch to cut a hole in the proper place in the material for reinstallation of the snap fastener. The hole should be only large enough for the barrel of the snap fastener to fit snugly.
- (5) Insert remaining half of the snap fastener on the barrel and clinch the halves together with the setting tool or the snap button machine.
- (6) Seal a patch over the inside of the snap fastener in order to make the garment leak proof.
- (7) If a snap fastener is torn out, clean and roughen up the area to be patched and install a patch on the outside of the garment to cover the hole left by the missing snap fastener.

Follow procedures in (4) through (7) above to install a new snap fastener.

11-6. REPAIR AND MAINTENANCE-Continued

- (d) Replacement of the slide fastener. Replace defective slide fasteners, using the applicable following procedures:
- (1) Remove the buttons on the coverall front to clear the sewing machine presser foot when sewing.
 - (2) Cut the slide fastener tapes from the garment, cutting as close to the facing as possible without damaging the fabric.
 - (3) Cut across below the scoop head extension and remove the slide fastener from the garment.
 - (4) Apply cement to the side of the new slide fastener tape that will be next to the fabric. Metal scoops must be kept free of cement.
 - (5) Position new slide fastener, using old tape as a guide.
 - (6) Starting at the bottom, set each side of the slide fastener to the sides of the opening, leaving a 3/16-inch (0.5 cm) space between scoops and edge of opening. Sew a double row of stitching, sewing along the old stitching lines.
 - (7) Apply cement over the stitching, and cement strapping to cover stitching on inside and outside of garment.
 - (8) Replace the buttons removed in (1) above.
 - (9) Thoroughly impregnate any thread exposed on the outside of the garment with protective coating.
 - (10) Apply dusting powder (talc) inside and outside the garment to prevent cement from adhering to other portions of the garment.
- (e) Replacement of thongs.
- (1) Remove the damaged thong from the slide fastener keeper.
 - (2) Cut a new piece of braid of sufficient length from the bulk stock supply
 - (3) Loop the braid through the slide fastener keeper and make a single loop knot in the ends of the braid to tie them together
- (f) Strapping Follow the procedures below for the repair and replacement of loose or missing strapping. After strappings have adhered properly, lightly dust seams inside and outside of garment with dusting powder (talc) to prevent cement from adhering to other portions of the garment.
- (1) Separation (1 inch or less)
-

11-6. REPAIR AND MAINTENANCE-Continued
--

- A. If seam strap separation is 1 inch or less, use a wooden tongue depressor (or similar wooden applicator) to spread cement over seam area and strapping surface as evenly as possible, working the adhesive with the applicator to obtain the complete coverage necessary for proper adhesion
- B. Insert the tongue depressor edgewise between seam and strapping to hold them apart so that solvent can dry out of adhesive to prevent bubble or "blow" void under strapping

NOTE

- **Break applicator into small pieces if necessary.**
 - **Adhesive is properly dry when solvent has evaporated. A convenient test can be made by pressing finger lightly to the drying adhesive; if adhesive is sticky to the touch but does not come off when finger is withdrawn, it is properly dry and the applicator can be removed.**
 - C. Carefully replace strapping over seam, and roll down firmly with 1to 2-inch (2.5 to 5.1 cm) metal roller with a 1/8to 1/4-inch (0.3 to 06 cm) rim and a smooth or slightly knurled rolling surface.
- (2) Separation. (2 inches (5 1 cm) or less (half seam). If seam strapping separation is up to half of seam width and extends more than 2 inches (5 1 cm) along one side of seam, repair it by following the instructions in (1) above. Modify separation for drying by using matchsticks as separators, in place of larger tongue depressors.
- (3) Separation (2 inches or longer).
- A. If seam strapping defect is greater than 2 inches (5.08 cm), peel strapping back 1/2 to 1 inch (1.27 to 2.54 cm) beyond area of separation without cutting the strapping. Repair by using techniques outlined in (1) above
 - B. Replace entire strapping which has become loose, damaged, or cut, with straps cut on the bias from bulk material.
 - C. Completely remove old straps, applying cement to one side of new strap and on area of garment from which old strap was removed.
- (4) Permit cement to dry to the point where it has a sticky touch but does not adhere to the finger.
- (5) Carefully place strap on garment, and roll down until a satisfactory adhesion has been obtained.
-

11-6. REPAIR AND MAINTENANCE-Continued

- (g) Sleeve closure ring. Follow the procedures below for the repair and replacement of damaged or missing closure rings. After the cemented portions have adhered properly, lightly dust seams inside and outside of garment with dusting powder (talc) to prevent cement from adhering to other portions of the garment.
- (1) Use an oil can to spray a light coating of "toluene" on the cemented area of the strapping securing the sleeve closure ring and wristlet to the cuff of the garment and carefully remove the strapping from the sleeve. Reapply the "toluene" as often as necessary to soften the cement while detaching strapping.

WARNING

Toluene is a poisonous, flammable compound. Use only in well ventilated areas. Avoid repeated and prolonged contact with skin. Keep away from heat and open flame.

- (2) Separate the wristlet from the sleeve closure ring, and remove the wristlet from the closure ring. Be careful not to stretch the wristlet.
- (3) Peel back the sleeve at the closure ring and remove the stitching securing the sleeve to the closure ring, being careful not to damage the sleeve. Separate the closure ring from the sleeve
- (4) Apply "toluene" to remove cement from all the surfaces to be repaired. Wipe off cement, and allow the surfaces to air-dry.
- (5) Use the abrasive strip furnished in the repair kit to roughen all the surfaces to be cemented, being very careful not to stretch the fabric.
- (6) Insert undamaged closure ring into the end of the sleeve $7/8 \pm 1/8$ inch ($O 320 \pm 0.318$ cm), and securely cement the ring to the sleeve.
- (7) Tack-stitch (three or four stitches) the sleeve to the closure ring at six places, spaced around the sleeve $5/16$ to $5/8$ inch (0.794 to 1.59 cm) from the top inner edge of the ring.

NOTE**Use Model 47W70 sewing machine**

- (8) Insert the closure ring into the wristlet so that the bead of the wristlet is $9/16 \pm 1/8$ inch (1.43 ± 0.318 cm) from the end of the closure ring
- (9) Cement the entire area of overlap from the bottom edge of the sleeve and the raw edge of the wristlet.

11-6. REPAIR AND MAINTENANCE-Continued

- (10) Cement and strap the outside of the wristlet raw edge with 1-1/4 +1/8 inch (3.17 ± 0.318 cm) wide strapping, overlapping the ends 1/2 to 5/8 Inch (1.27 to 1.59 cm) at the seam of the sleeve.
 - (11) Apply a coating of protective coating to all the edges of the cemented repair to seal them effectively. Apply a second coating after the first one dries thoroughly.
- (c) Gas mask hoods (full and limited protection).
1. Cleaning Refer to TM 3-220 for the cleaning and decontamination of the rocket fuel handlers' protective hoods
 2. Inspection
 - (a). Inspect the fabric for holes, rips, cuts, or exposed base fabric.
 - (b). Inspect the strapping for proper adhesion to the fabric, blistering (air bubbles) between the strapping and the fabric, and exposed stitching.
 - (c). Inspect the draw cords and shoulder straps for loose ends not caught in the stitching, cuts, tears, and missing snap fasteners and slides
 - (d). Inspect for malformed, distorted, or missing buckles.
 - (e). Inspect the facepiece for cuts, scratches, strains, clearness, loose or missing screws and nuts, and broken or missing cork reinforcement.
 3. Repair.
 - (a). Patching. Patch a hole 1/4 Inch In diameter or a rip 2 inches (5.08 cm) In length by use of the rocket fuel handlers' impermeable repair kit. A hole that exceeds 1/4 Inch (0.635 cm) In diameter or 2 inches (5.08 cm) in length, but does not exceed 3 inches (2.62 cm), will be patched as described In subparagraph (b)3(a). The maximum number of patches allowed on the protective hood is three.
 - (b). Replacement of tie tapes.
 - (1) Separate the fabric where the tie tape is attached to the hood and separate the tie tape from the fabric. Remove the keeper from the tie tape.
 - (2) Measure an undamaged tie tape (to include folds and turn unders) and cut a length from the bulk stock.
 - (3) Place the keeper on the new tape and cement the end of the tape to the keeper.
 - (4) Fabricate a new strap end from bulk material. If the strap end is damaged. Install a new snap fastener as described in subparagraph (b)3(c)
 - (5) Install the new tie tape on the hood (sewing or cementing as required) and cement the fabric.
 - (6) Apply protective coating over the stitching or patch on the inside of garment and allow to set. Sprinkle powdered talc on the sealer to prevent adhesion to other parts of the hood.
 - (c) Replacement of snap fasteners.
 - (1) If a snap fastener is torn out, clean and roughen up the area to be patched and install a patch on the outside of the garment to cover the hole left by the missing fastener
 - (2) Install a new snap fastener as described In subparagraph (b)3(c).
 - (3) Seal a patch over the inside of the fastener In order to make the hood leakproof.

11-6. REPAIR AND MAINTENANCE-Continued

(2) Toxicological agents protective clothing

(a) General

1. This section prescribes the cleaning, inspection, and repairs to be performed on the toxicological agents protective clothing
2. Cleaning and repair will be performed by personnel skilled in the particular trade applicable to their duties in the maintenance of subject items. Items will be complete, satisfactorily repair, and free of all defects affecting serviceability

(b) Coveralls and aprons.

1. Cleaning Refer to TM 3-220 for the cleaning and decontamination of toxicological agents' protective coveralls and aprons
2. Inspection
 - a. Inspect the fabric for holes, cuts, rips, or exposed base fabric
 - b. Inspect the strapping for proper adhesion to the fabric, blistering (air bubbles) between the strapping and the fabric, and exposed stitching Probe for tunnels using the end of a straightened paperclip. Repair tunnels using a syringe and/or needle to seal/close the damaged area
 - c. Inspect the sleeve closure straps, snap fasteners, and hardware for secure mounting
 - d. Inspect the slide fastener for damaged scoops, broken or disconnected slider, missing thong, self-sealing, and ease of operation
 - e. Inspect for missing or nonfunctioning snap fasteners, broken or missing belt hook and eye, and malformed or distorted buckles
 - f. Inspect for loose or missing buttons
 - g. Inspect for loose or missing tie tapes and adjusting straps
3. Repairs
 - (a) Patching Maintenance Kit, TAP Clothing, NSN 8415-00-889-3654 provides materials and instructions for emergency field repair of TAP clothing items Patch a hole 1/2 inch in diameter by use of the toxicological agents protective clothing repair kit. A hole that exceeds 1/2 inch in diameter or a rip that does not exceed 3 Inches will be patched as described in subparagraph d(1Hb) 3.(a). The maximum number of patches allowed on the coveralls or aprons is three per section.
 - (b) Replacement of tie tapes.
 - (1) Remove the stitching where the damaged tape is attached to the garment.
 - (2) Measure an undamaged tape (to include folds and turn unders) and cut a length from the bulk stock.

11-6. REPAIR AND MAINTENANCE-Continued

- (3) Sew turn-unders and folds into the tapes and make buttonholes or install buttons, as necessary.
 - (4) Sew the new tape to the garment with a single-X box stitch, making sure that thread ends are backstitched or cross-stitched
 - (5) Apply cemented patch to inside of garment to cover threads for waterproofing. Apply sealer to outside of garment
 - (6) Apply powdered talc to inside and outside of the garment when the sealer has set to prevent the repaired portion of the garment from sticking to other portions of the garment
- (c) Replacement of snap fasteners
- (1) If a snap fastener is torn out, clean and roughen up the area to be patched and install a patch on the outside of the garment to cover the hole left by the missing fastener
 - (2) Install a new snap fastener as described in subparagraph d(1)(b)3 (c)
 - (3) Seal a patch over the inside of the garment in order to make the garment waterproof
- (d) Replacement of slide fasteners Refer to subparagraph d(1)(b)3 (d) for the procedures for replacement of the slide fasteners
- (e) Replacement of thongs
- (1) Remove the damaged thong from the slide fastener
 - (2) Cut a new piece of braid of sufficient length from the bulk stock supply
 - (3) Loop the braid through the slide fastener keeper and make a single loop knot in the ends of the braid to tie them together
- (f) Replacement of hardware items
- (1) Remove the stitching and separate damaged buckles and fasteners from the garment
 - (2) If the belt or adjusting strap is damaged, cut new piece of webbing or fabric from bulk stock and make new belt or adjusting strap
 - (3) Install new hardware on belt or adjusting strap and install belt or strap on garment

11-6. REPAIR AND MAINTENANCE-Continued

- (4) If stitching goes through fabric in a critical area of the garment, install a cement patch over the stitching and apply sealer. Apply powdered talc to inside and outside of garment to prevent repaired portion of the garment from sticking to other portions of garment.

(g) Buttons.

- (1) Remove stitching securing damaged buttons to the garment and remove the button and reinforcing webbing.
- (2) Apply cement or sealer to both sides of the fabric where the button was removed and allow to dry.
- (3) Place new button and reinforcement in position and attach with proper sewing or tack button machine.

(h) Braid.

- (1) Remove plastic slide keeper from braid.
- (2) Remove braid from the gusset of the garment.
- (3) Measure a new piece of braid of sufficient length from the bulk stock material.
- (4) Install the braid in the gusset.
- (5) Install the slide keeper on the braid and tie ends of braid together.

(c) Gas mask hood

1. Cleaning. Refer to TM 3-220 for the cleaning and decontamination of the toxicological agents protective hood.

2. Inspection.

- (a) Inspect the fabric for holes, rips, cuts, or exposed fabric.
- (b) Inspect the strapping for proper adhesion to the fabric, blistering (air bubbles) between the strapping and the fabric, and exposed stitching.
- (c) Inspect the draw cords, tie tapes, and shoulder straps for loose ends not caught in the stitching, cuts and tears, or missing snap fasteners.

3. Repair.

- (a) Patching. Patch a hole 1/2 inch in diameter by use of the toxicological agents' protective clothing repair kit. A hole that exceeds 1/2 inch in diameter or a rip that does not exceed 3 inches will be patched as described in sub-paragraph d(1)(b)3.(a). The maximum number of patches allowed on the gas mask hood is three.

11-6. REPAIR AND MAINTENANCE-Continued

(b) Replacement of tie tapes

- (1) Remove the stitching that secures the tie tape to the hood. Separate the cemented fabric, where applicable, and remove the tape from the hood.
- (2) Measure an undamaged tape (to include folds and turn unders) and cut a length from the bulk stock.
- (3) Install buckles on tape and install snap fasteners as prescribed in subparagraph d(1)(b)3(c).
- (4) Sew the new tape to the hood with a single-X box stitch, making sure that the thread ends are stitched or cross-stitched.
- (5) Apply a cemented patch on the inside of the hood to cover the stitching. Apply sealer to the outside of the hood at the stitching.

(c) Replacement of snap fasteners.

- (1) Install new snap fasteners as described in subparagraph d(1)(b)3(c).
- (2) Apply a sealing patch to the inside of the hood to cover the inner portion of the snap fastener.

(d) Footwear covers

1. Cleaning. Refer to TM 3-220 for the cleaning and decontamination of the footwear covers.
2. Inspection.
 - (a) Inspect the fabric for holes, tears, and exposed base fabric.
 - (b) Inspect the tie tapes for tears and secure mounting to the covers.
3. Repair. Patch holes up to 1/2-inch in diameter by use of the toxicological agents' repair kit.

(e) Boots, M2A1 (NSN 8430-00-820-6295 series).

1. Cleaning. Refer to TM 3-220 for cleaning and decontamination of boots.
2. Inspection. Inspect the fabric for holes, cuts, or exposed base fabric.
3. Repair. Patch holes up to 1/2 inch in diameter by use of the toxicological agents' protective clothing repair kit. A hole that exceeds 1/2 inch in diameter or a rip that does not exceed 2 inches will be patched as prescribed in subparagraph d(1)(b)3(a). The maximum number of patches allowed on the boot uppers is three. The sole and instep areas will not be patched.

11-6 REPAIR AND MAINTENANCE-Continued
--

(3) Explosive handlers' coveralls.

(a) General.

1. This section prescribes the cleaning, inspection, and repairs authorized to be performed on the explosive handlers' clothing.
2. Cleaning and repair will be performed by personnel skilled in the particular trade applicable to their duties in the maintenance of subject items. Finished items will be complete, satisfactorily repaired, and free of all defects affecting serviceability and appearance.

(b) Explosive handlers' coveralls.

1. Cleaning. After each use, the coveralls should be laundered in a mild soap and water solution. The coveralls **SHOULD NOT BE STARCHED** because the stiffening effect of the clothing could cause static electricity to be generated while the clothing is being worn.
2. Inspection. Inspect the coveralls for loose or missing buttons, ripped or weakened seams, and torn fabric.
3. Repair. Darn and patch the fabric, using the procedures described in subparagraph d(1)(d)3. Replace damaged or missing buttons by sewing new ones on the garment with the button sewing machine.

Section III. MATERIALS - Continued

SMR CODE	NATIONAL STOCK NUMBER	DESCRIPTION	REFERENCES
XBF		<p style="text-align: center;">CLOTH</p> <p>Cloth, Cotton, Terry, Olive Green 35 in Wide, MIL-C-1164</p>	<p>YD Ref para 11 -6d(l1)(b)3 11-6d(l)(d)3(e)</p>
XBF		Cloth, Cotton, Sateen, Impregnated	11 -6d(2)(e)3
XBF		Cloth, Cotton, Sateen, Natural	YD Ref para 11-6d(3)(b)3
XBF		8 5 Oz Per Sq Yd	YD Ref para 11-6d(3)(d)3
XBF		Cloth, Coated, Cotton, Resin Modified, Butyl Coated	YD Ref para 11 -6d(l)(b)3
PAF	8415-00-753-6212	<p style="text-align: center;">GLOVES, ROCKET FUEL HANDLERS</p> <p>Gloves, R/Fuel Handler, Small</p>	PR
PAF	8415-00-753-6213	Gloves, R/Fuel Handler, Medium	PR
PAF	8415-00-753-6214	Gloves, R/Fuel Handler, Large	PR
PAF	8415-00-753-6215	Gloves, R/Fuel Handler, X-Large	PR
PAF	8315-00-254-0184	<p style="text-align: center;">TAPE</p> <p>Tape, Textile, Plain Weave Cotton, 3/4 in Wide, 100 Lb Breaking Strength, Class 1, Type I, MIL-T-43506</p>	YD Ref para 11 - 6D(3)(d)3
PAF	8310-01-066-0973	<p style="text-align: center;">THREAD</p> <p>Thread, Polyester Core, Cotton-Rayon or Polyester-Covered, Olive Drab, Part No MIL-T-43548 (81349)</p>	CE Ref para 11 - 6d(1)(d)3
PAF	8310-00-262-0072	Thread, Cotton, Olive Drab, Army Shade T-1, 3 Piles, Ticket No 50, Type 1 A3, Fed Spec V-T-276	CE Ref para 11-6d(2)(e)3
PAF	8310-00-264-5830	Thread, Cotton, Olive Drab, Army Shade S-1, 2 Plies, Ticket No 70, Type 1 A3, Fed Spec V-T-276	CE Ref para 11-6d(2)(b)3(b)
PAF	8310-00-187-3919	Thread, Cotton, Olive Drab, Army Shade S-1, 3 Piles, Ticket No 50, Type 1 A3, Fed Spec V-T-276	SL Ref para 11- 6d(2)(b)3(b)
PAF	8310-00-187-3917	Thread, Cotton, Olive Drab, Army Shade S-1, 3 Plies, Ticket No 40, Type 1 A3, Fed Spec V-T-276	SL Ref para 11-6d(3)(b)3
PAF	8310-00-262-0094	Thread, Cotton Gimp, Olive Drab, Army Shade S-1, 3 Plies, Ticket No 8, Type II Fed Spec V-T-280	TU Ref para 11- 6d(2)(b)3(b)
PAF	8310-00-187-3918	Thread, Cotton, Olive Drab, Army Shade S-1, 3 Plies, Ticket No 40, Type 1 A3, Fed Spec V-T-276	CE Ref para 11 - 6d(2)(b)3(b)
PAF	8310-00-262-0096	Thread, Cotton Gimp, Olive Drab, Army Shade S-1, 3 Plies, Ticket No 8, Type I, Fed Spec V-T-280	TU Ref para 11-6d(3)(b)3
PAF	8310-00-187-3886	Thread, Cotton, Natural 3 Piles Ticket No 30, Type 1A1, Fed Spec V-T-276	CE Ref para 11-6d(3)(b)3

Section III. MATERIALS - Continued

SMR CODE	NATIONAL STOCK NUMBER	DESCRIPTION	REFERENCES
PAF	8310-00-187-3840	Thread, Cotton, White 3 Plies, Ticket No 50, Type 1A2, Fed Spec V-T-276	CE Ref para 11-6d(3)(d)3 11-6d(1)(b)3
PAF	8310-00-281-3368	Thread, Cotton, Black, 4 Plies, Ticket No 30, Type 1A3, Fed Spec V-T-276	CE Ref para 11-6d(1)(c)3(c)
PAF	8305-00-260-1745	WEBBING Webbing, Textile, Cotton, Olive Drab Army Shade 7, 5/8 In Wide, 195 Lb Breaking Strength Type 11la M I L-W-530	YD Ref para 11-6d(2)(b)3(b)
PAF	8305-00-260-1745	Webbing, Textile, Cotton, Olive Drab, Army Shade 7, 5/8 In Wide 200 Lb Breaking Strength Type II, MI L-W-530	YD Ref para 11-6d(2)(b)3(b)
PAF	8305-00-260-1757	Webbing, Textile, Cotton, Olive Drab, Army Shade 7, 3/4 In Wide, 230 Lb Breaking Strength, Class 3, Type I la, M I L-W-530	YD Ref para 11-6d(2)(b)3(b)
PAF	8305-00-260-1748	Webbing, Textile, Cotton, Olive Drab, Army Shade 7, 3/4 In Wide, 230 Lb Breaking Strength, Class 4, Type I la, MIL-W-530	YD Ref para 11-6d(2)(b)3(b)
PAF	8305-00-260-1749	Webbing, Textile, Cotton, Olive Drab, Army Shade 7, 5/8 In Wide, 195 Lb Breaking Strength, Class 4, Type I la, M I L-W-530	YD Ref para 11-6d(2)(b)3(b)
PAF	8305-00-260-1746	Webbing, Textile, Cotton, Olive Drab, Army Shade 7, 2 InWide, 580 Lb Breaking Strength, Class 4, Type I la, M I L-W-530	YD Ref para 11-6d(2)(b)3(b)
PAF	8305-00-260-1744	Webbing, Textile, Cotton, Olive Drab, Army Shade 7, 3/4 In Wide, 235 Lb Breaking Strength, Class 3, Type II, M I L-W-530	YD Ref para 11-6d(1)(b)3
PAF	8315-00-297-1553	BRAID Braid, Textile, Solid, Cotton, Olive Green, Army Shade 107, 3/16 In Wide, 16.5 Oz Per Gross Yd, Type III, MIL-B-371	YD Ref para 11-6d(2)(b)3(b)(4)
PAF	8315-00-252-3004	Braid, Textile, Flat, Cotton, Olive Green, Army Shade 107, 6/32 in Wide, 16.5 Oz Per Gross Yd, Type III, MIL-B-371	YD Ref para 11-6d(2)(b)3(b)

Section III. MATERIALS - Continued

SMR CODE	NATIONAL STOCK NUMBER	DESCRIPTION	REFERENCES
XBF		Braid, Textile, Flat, Cotton, Black, 11/32 InWide, Type VII, MIL-B-371	YD Ref para 11 -6d(1)(c)3(b)
		FASTENERS	
PAF	5325-00-292-5343	Fastener, Snap, Brass, Bronze Finish, Style 2A, MIL-F-10884	HD Ref para 11-6d(1)(d)3(h) 11-6d(2)(b)3(b) (3)
PAF	5325-00-290-5930	Fastener, Snap, Brass, Enamel Finish, Socket and Cap, AN 227-11 B-12B	EA Ref para 11-6d(1)(d)3(h) 11-6d(2)(b)3(b) (3)
PAF	5325-00-292-5340	Fastener, Snap, Brass, Oxide Finish, Socket and Chip, Style 2, MIL-F-10884	SE Ref para 11-6d(1)(b)3(c) 11-6d(1)(c)3(c)
PAF	5325-00-290-5933	Fastener, Snap, Brass, Enamel Finish, Stud and Post, AN 227-8B-9B	HD Ref para 11-6d(1)(b)3(c) 11-6d(1)(c)3(c)
PAF	5325-00-814-9344	Fastener, Slide, Interlocking, 27 In Lg, Size MHS, Style 3, Class A, Type I, MIL-V-F-106 (For Small Size Coveralls)	EA Ref para 11-6d(2)(b)3(c)
PAF	5325-00-814-9347	Fastener, Slide, Interlocking, 28 In Lg, Size MHS, Style 3, Class A, Type I, MIL-V-F-106 (For Medium Size Coveralls)	EA Ref para 11-6d(2)(b)3(c)
		BUCKLES	
PAF	5340-00-820-7838	Buckle, Brass, Tongueless, Double Bar, 5/8 InMI L-B-543	EA Ref para 11-6d(2)(b)3(b) (3)
PAF	5340-00-297-6631	Buckle, Brass, Black, Chemical Finish, Tongueless, w/br, 5/8 In Strap Width, 13/16 In Lg O/A, 61/64 In. Wide, MS51927-1	EA Ref para 11-6d(2)(b)3(b) (3)
PAF	5340-00-290-0847	Buckle, Steel, Phosphate, Coated Finish, Black Enamel, Tongueless, Double Bar, 3/4 In Strap Width, 4-7/16 In O/A, 7/8 In Wide, MIL-B-2288	EA Ref para 11-6d(2)(b)3(b) (3)
		BUTTONS	
PAF	8315-00-163-1523	Tack, Button, Steel, Oxidized, Black, Line 17, Type IX, MIL-B-286	GR Ref para 11-6d(2)(b)3(b)
PAF	8315-00-163-1514	Button, Tack, Steel, Oxidized, Black, Line 27, Style 1, Type II, MIL-B-286	GR Ref para 11-6d(3)(b)3
PAF	8315-00-163-1522	Tack, Button, Steel, Oxidized, Black, Line 14, Type IX, MIL-B-286	GR Ref para 11-6d(3)(b)3

Section III. MATERIALS - Continued

SMR CODE	NATIONAL STOCK NUMBER	DESCRIPTION	REFERENCES
PAF	5325-00-641-1611	Grommet, Metallic, Brass, Black Finish, No 00, w/washer	EA Ref para 11-6d(2)(b)3
PAF	5340-00-291-4987	Loop, Slide, Brass, Bronze Finish 2 In Class 1, Style 2, MIL-L-3851	EA Ref para 11-6d(2)(b)3
		MISCELLANEOUS	
PAF	6810-01-100-4176 I	Tuolene, Reagent, (87570)	EA Ref para 11-6b(5)(g)1
PAF	5305-00-984-4982	H602NT Screw, Machine, Pan Head, Slotted Steel, No 6-32, 3/16 Lg	EA Ref para 11 -6d(1)(c)2
PAF	8315-00-162-1106	Button, Sewing Hole, Melamine Formaldehyde, White, Line 30, Style 20 4 Hole, Class D, Type II, Fed Spec V-B-871	GR Ref para 1 1-6d(1)(b)3
PAF	8315-00-269-1359	Button, Sewing Hole, Melamine Formaldehyde, Olive Green, Army Shade BP, Line 30, Style 20 or 21, 4 Hole, Class D, Type II, Fed Spec V-B-871	GR Ref para 11-6d(2)(b)3 14-6d(3)(b)3
PAO	8440-00-221-0852	Suspenders, Trousers, Scissors Type Back, Olive Green, Army Shade 107, MIL-S-10926A	PR
PAF	9320-00-286-5473	Rubber Strip, Cellular, Black Cured Natural Rubber, Exposed Cell Structure, 1/4 In Thick, 2 In Wide, 300 In Lg, Class RN, Type R, MIL-C-3133	EA Ref para 11-6d(2)(b) 3
		REPAIR KITS	
PAO	8415-00-889-3654	Maintenance Kit, Toxicological Agents Protective Clothing, Butyl Rubber Coated, MII-M-41837	EA Ref para 11-6b 11-6d(2)(b)3
PAO	8465-00-753-6335	Maintenance Kit, Cold Weather Insulated Boot, Pneumatic Mattress MIL-M-14545	EA Ref para 11-6b 11-6d(2)(b)3
PAO	8415-01-155-0396	Maintenance Kit, Rocket Fuel Handlers' Clothing, Impermeable, Butyl Rubber Coated, MIL-M-43120 (Dynatech Corp Bacon Lab Div 17 Tudor St Cambridge, Mass)	EA Ref para 1 1-6b 11-6d(1)(b)3

CHAPTER 12
MAINTENANCE OF LINERS FOR COLD WEATHER
CLOTHING, DESERT PARKA, AND PONCHO

Section I INTRODUCTION

12-1. SCOPE

This chapter prescribes the procedures and instructions for repair of the liners for cold weather coat and trousers, the extreme cold weather parka, the desert parka, and the wet weather poncho

12-2. COMMODITY SPECIFICATIONS

a. Items.

SPECIFICATION	ITEM
MIL-L-43335	Liner, Wet Weather Poncho
MIL-L-43466	Liner, Extreme Cold Weather, Parka
MIL-L-43498	Liner, Cold Weather Trousers, Field
MIL-L-43536	Liner, Cold Weather Coat
MIL-L-43672	Liner, Snow Camouflage, Trousers, White, Arctic-M-65
MIL-L-44089	Liner, Night Camouflage, Parka, Desert

b. Components.

SPECIFICATION	ITEM
V-B-871	Button, Sewing Hole, and Button, Staple (Plastic)
V-L-61	Laces, Nylon
V-T-280	Thread, Cotton Gimp, Buttonhole
V-T-285	Thread, Polyester
V-T-295	Thread, Nylon
MIL-C-508	Cloth, Oxford, Nylon, 3 Ounces
MIL-B41826	Batting, Synthetic Fibers (Quilted and Unquilted)

12-2. COMMODITY SPECIFICATIONS - Continued

b. Components (Continued)

SPECIFICATION	ITEM
*MIL-T-43548 *JJ-W-1 55 *MIL-T-43566 A-A-50198 A-A-50199	Thread, Polyester, Cotten Covered and Rayon Covered Webbing, Textile (Cotton Elastic) Tape, Textile, Cotton or Polyester, General Purpose, Natural or in Colors Thread, Gimp Cotton Buttonhole Thread, Polyester Core-Cotton or Polyester Covered

c. Technical Publications. Publications not listed In chapter 1

SPECIFICATION	ITEM
FM 10-16	General Fabnc Repair

12-3. IDENTIFICATION AND DESCRIPTION

- a. Liner, Extreme Cold Weather Parka, nylon quilted, Army Shade 106, MIL-L-43466 (NSN's 8415-00-782-2881 through 2885), Figure 12-1. The extreme cold weather parka liner is an olive green under-garment of polyester batting covered with 3 plys of ripstop nylon cloth and is worn with the parka for additional insulation. The liner is a three-quarter length cardigan style garment with bound edges. Buttonholes along the neck and front edges and tabs on the sleeve bottoms are provided for attaching the liner to the parka.
- b. Liner, Cold Weather Coat, nylon quilted, Army Shade 106, MIL-L-43536 (NSN's 8415-00-782- 2886 through 2890), Figure 12-1. The cold weather coat liner is an olive green undergarment of polyester batting covered with 3 plys of ripstop nylon cloth and is worn with the cold weather coat for additional insulation. The liner is a hip-length, collarless, cardigan style garment with bound edges. Buttonholes at the neck and front edges and buttonhole tabs at the sleeve bottoms are used to attach the liner to the inside of the coat
- c. Liner, Cold Weather Trousers, Field, Green US Army 106, MIL-L-43498 (NSN's 8415-01-180-0370 through 0377), Figure 12-2. Trousers liner made from quilted polyester batting material, for the Cold Weather Field Trousers.
- d. Liner, Trousers, nylon quilted, natural, MIL-L-43672 (NSN's 8405-00-935-0546 through 0553), Figure 12-2. The quilted camouflage trouser-liner is a natural color undergarment of polyester batting covered with 3 plys of nylon parachute cloth with a side opening waistband.

12-3. IDENTIFICATION AND DESCRIPTION - Continued

- e. Liner, Night Camouflage, Parka, Nylon quilted, Army Shade 106, MIL-L-44089 (NSN's 8415-01-102-4481 through 4485), Figure 12-3. The desert night parka liner is an olive green undergarment of polyester batting covered with 3 plies of ripstop nylon cloth and is worn with the desert night parka for additional Insulation. The liner is a three-quarter length cardigan style garment with bound edges. Button-holes along the neck and front edges and tabs on the sleeve bottoms are provided for attaching the liner to the parka.
- f. Liner, Wet Weather Poncho, nylon quilted, camouflage color, MIL-L-43335 (NSN 8405-00-889- 3683), Figure 12-4. The poncho liner is a polyester batting article covered with 3 plys of ripstop nylon and is intended for use as a blanket or sleeping bag component. The liner has eight tie tapes for attaching it to the poncho.

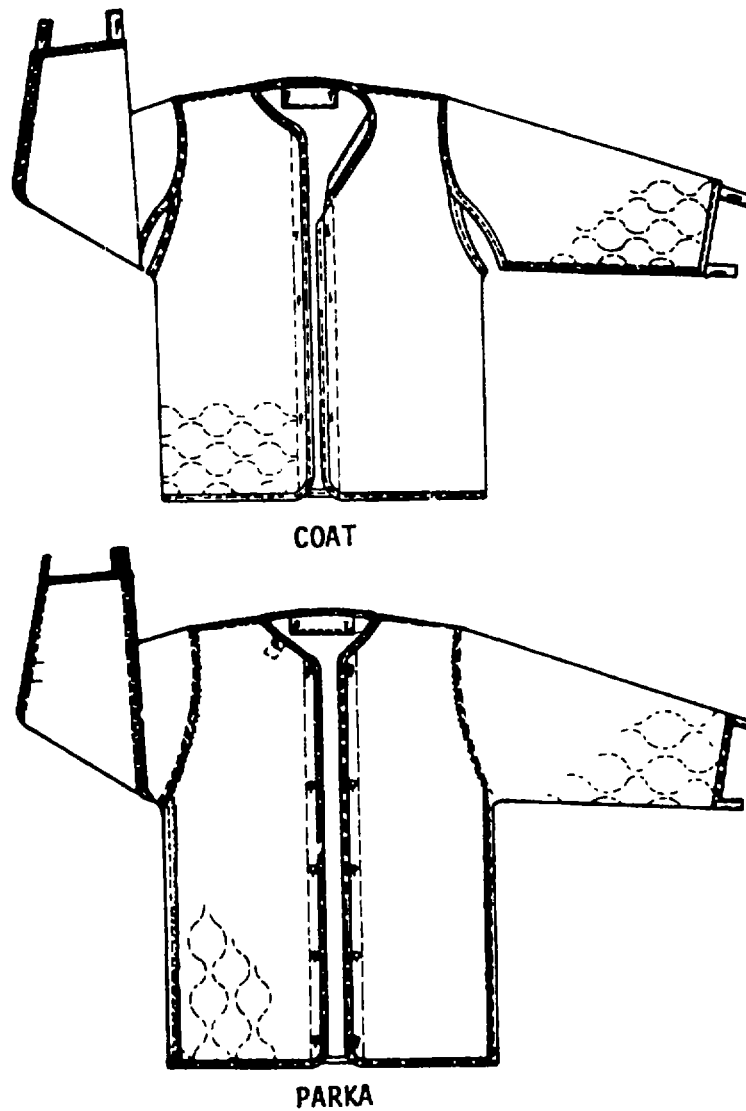

Figure 12-1. Cold Weather Parka and Coat Liners.

12-3. IDENTIFICATION AND DESCRIPTION-Continued

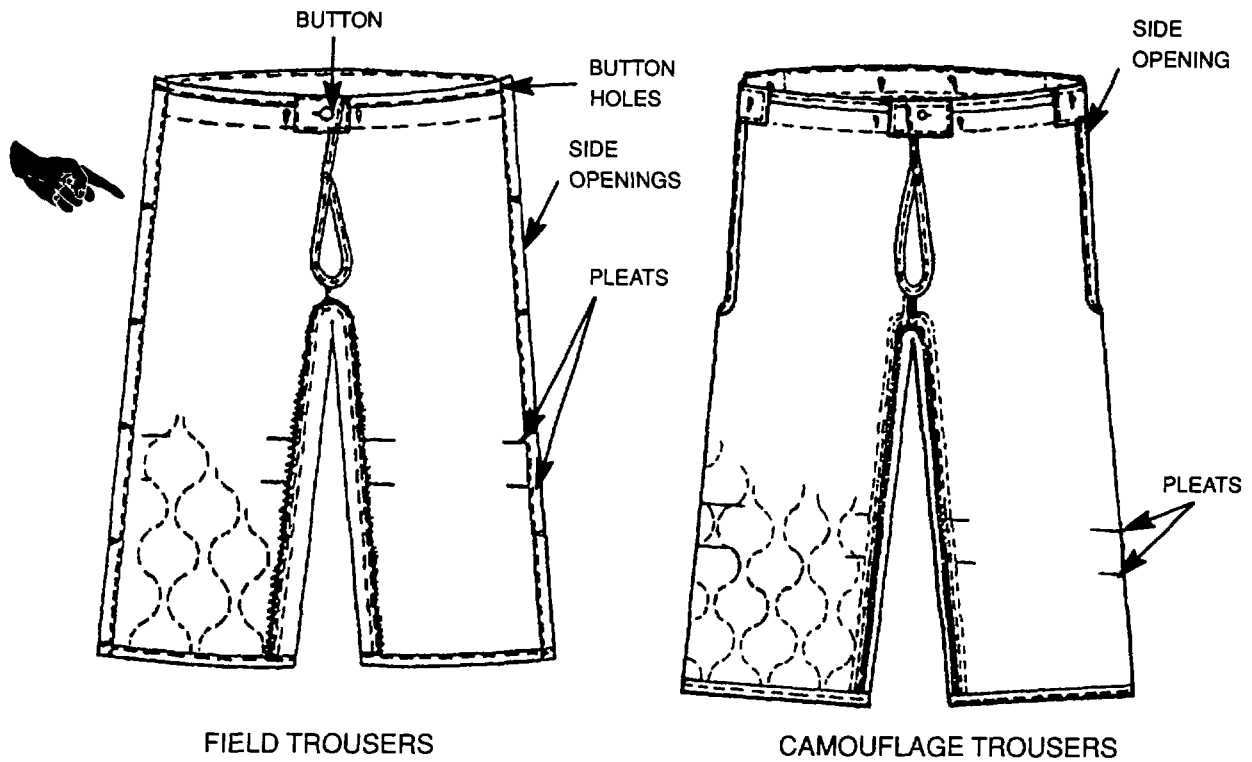

Figure 12-2. Trousers Liners.

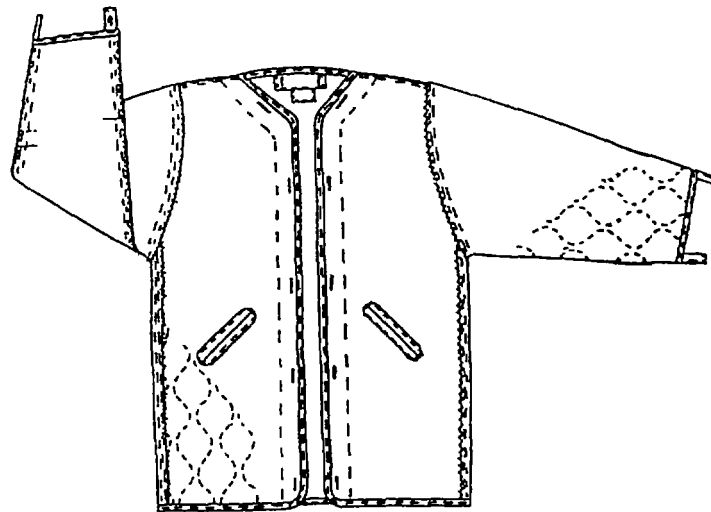

Figure 12-3. Desert Parka Liner

12.3. IDENTIFICATION AND DESCRIPTION- Continued.

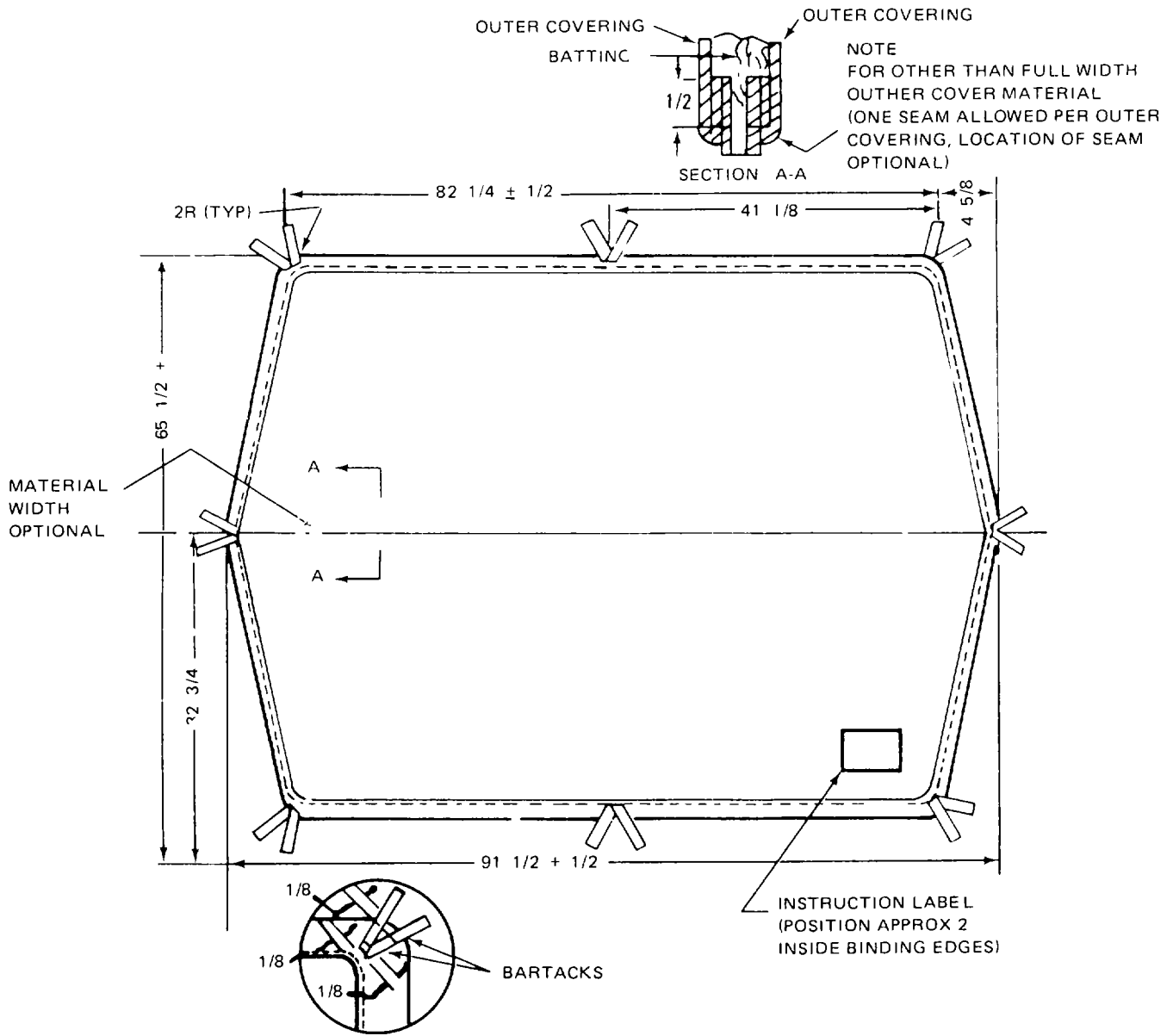

Figure 12-4 Wet Weather Poncho Liner.

Section II. REPAIR PROCEDURES**12-4. MATERIALS**

Materials used in the repair of the clothing and poncho liners will be materials recovered from similar salvaged items when authorized or will be new materials as specified in Section III. New materials will be requisitioned from stock under the stock number and/or items description and shall conform to appropriate specification. When not available from stock, the materials may be purchased locally that conform as closely as possible to the standard material.

12-5. CLASSIFICATION

Refer to Chapter 1 for serviceability classification of liners.

12-6. REPAIR AND MAINTENANCE

Prior to repair operations, each liner shall be inspected by qualified personnel to determine the amount of repair necessary. Repairs will be made as fully as skills, facilities, funds, and local conditions permit. Inspectors will determine whether repairs can be accomplished within the using organization or evacuate to direct support level of maintenance.

- a. **Cleaning.** Remove dirt, mud, or other foreign matter with damp or dry cloth. Rub exceedingly dirty areas with limited amounts of water that will not saturate the polyester batting, rinse and dry thoroughly. Garments that require laundering will be processed in Army facilities in accordance with established laundry practices set forth in FM 10-280. **QUILTED GARMENTS WILL NOT BE DRY CLEANED.**
- b. **Organizational Repair.** Repairs to be accomplished at organizational maintenance are limited to replacing missing or damaged buttons, applying pressure sensitive patches, and mending small rips and tears by hand sewing. To prevent loss of polyester batting, all tears and holes or other openings in the liner will be repaired. There is no limit to the number of times the liner may be patched, provided repair costs do not exceed 35 percent of the acquisition cost of the item. Any filling material (polyester batting) which has been lost through holes or tears will be replaced with filling material taken from salvaged liners or material conforming to Type III, Class 3, Style A, MIL-B-41826. Insert sufficient filling material to obtain about the same bulk as in adjacent undamaged channels. Apply pressure sensitive patches to liner covers where damage does not extend into a seam as follows:
 - (1) Lay out the liner with the damaged area exposed and trim ragged, frayed, or torn areas of cloth in order to provide smooth area for patch.
 - (2) Determine size of patch required and mark around damaged area. Measure and cut pressure sensitive adhesive repair tape to shape. Patches should overlap edges of damaged area by 3/4 inch. Round off corners of patches.
 - (3) Remove paper backing from repair tape. To remove backing, crease and score with fingernail, being careful not to damage cloth, and peel paper backing from tape.

12-6. REPAIR AND MAINTENANCE-Continued

- (4) Remove wrinkles from area to be repaired and apply patch over damaged area on the outside. Press to smooth patch in place.
- (5) When holes exceed two inches, apply a patch to the inside fabric before applying outside patch. TEMPORARY PATCHES WILL NOT HOLD FOR LAUNDERING

c. Direct Support Maintenance.

- (1) Preliminary examination. Dirt, mud, dust, spots, stains, and other foreign matter shall be removed with a brush or by laundering. Mildewed and rotten items shall be discarded. Seams shall be tested by grasping the garment with both hands and pulling at right angles to the seam. Areas to be repaired shall be marked with crayon. Non-specification and personnel marks shall be erased or obscured.
- (2) Stitching and restitching. Use machine stitching wherever possible for all stitching and backstitching. Backstitch or bartack all stitching at ends to prevent raveling. Maintain proper thread tension to prevent loose stitching and to imbed the lock in the center of material sewn. The looper thread should be on the outside of the garment. Backstitch type 301 stitching not less than 1 inch at each break. Overlock thread breaks in overedge stitching not less than 3/4 inch (1.91 cm). Thread size shall conform to V-T-276 of the types and sizes listed below.

FOR CLOTHING LINERS (NYLON THREAD)

USE	STITCH	NEEDLE/BOBBIN THREAD		STITCHES PER INCH
General	301 or 401	B	B	10-14
Buttonhole	---	B	AA	10-14
Button	301 or 101	B	B	52-56 (buttonhole) 14-16
Overedging	503 or 504	B	- - AA	20-24 8-10
Bartacking		-- --- B	B	28 (bartack)

FOR PONCHO LINER (POLYESTER THREAD)

General	301	B		B	10-12
Bartack	---	B		B	28 (bartack)

12-6. REPAIR AND MAINTENANCE-Continued

- (3) Patching and darning. Patch holes or worn areas exceeding 1/8 Inch (0.318 cm) on any surface. Precut patches of matching material for uniformity. Cut patches to extend approximately 3/4 inch (1.91 cm) around perimeter of opening, providing not less than 3/8 inch (0.953 cm) turn-under at all edges except selvage edges. Darn holes and worn areas of less than 1/4 Inch (0.635 cm). Turn under frayed hems and edges and restitch. Use sharp needles to sew lining to prevent large needle holes or cutting the fabric.
- (4) Buttons and buttonholes. Replace damaged or missing buttons with matching serviceable or new buttons. Properly align replacement button with corresponding buttonhole. Rework damaged buttonholes over gimp to match original design. Pull and shape by hand or machine stitch a matching small reinforcement patch on the underside and rework through the patch.
- (5) Binding tape. Overlap the damaged binding tape with new tape extending 1 inch beyond the damaged area. Turn binding edges under 1/2 Inch (1.27 cm) and stitch 1/8 inch (0.318 cm) from edge of tape.
- (6) Tie tapes (poncho liner). Replace tapes which have holes or tears by carefully cutting the stitching securing the damaged tie tape to the liner and remove the tie tape. Cut a length of spun nylon facing for each tie tape to be replaced. Fuse tie tape end or impregnate with cellulose acetate or cellulose acetate butyrate. Fold tie tape in half and bartack across folded end to liner. Spread tapes so that inside edges are abutted and bartack across the width of both tapes 1/2 to 3/4 Inch (1.27 to 1.91 cm) below first bartack.

12-7. RESIZING

After cleaning and repair have been accomplished, resize liners according to sizes listed in the appropriate table. The finished measurements for the parka liner are length, no less than 89-1/2 Inches (227.3 cm) and width no less than 64-1/2 inches (163.8 cm), however, dimensional deficiency is not sufficient reason for classifying the item as condition code H. When items deviate in size from original markings, obliterate the old marking and print or stamp the proper size with indelible pencil or waterproof ink near the old size. When measurements do not correspond to a size listed, mark the item with the next lowest size.

12-7. RESIZING - Continued

Table 12-1. Parka Liner Finished Measurements

SIZE	X-SMALL	SMALL	MEDIUM	LARGE	X-LARGE	TOLERANCE
	INCHES	INCHES	INCHES	INCHES	INCHES	INCHES
1/2 chest 1/	25	27	29	31	33	± 3/4
Back length 2/	32 1/2	33	33 1/2	34	34 1/2	± 3/4
Sleeve length 3/	24	24 1/2	25	25 1/2	26	± 3/4

1/ Measurement shall be taken, with liner flat and front edges abutting, from the folded edge to folded edge at base of armholes.

2/ Measured from top edge at neck to bottom edge along center back.

3/ Measure overedged side of back arm seam from top of overedge stitching at armhole to bottom of sleeve with no tension applied to seam.

Table 12-2. Cold Weather Coat Liner Finished Measurements

SIZES	1/2 CHEST 1/	BACK LENGTH 2/	SLEEVE LENGTH 3/
	INCHES	INCHES	INCHES
X-Short - X-Small	22 1/4	26	21
X-Short - Small	24 1/4	26 1/2	21 1/4
X-Short - Medium	26 1/4	27	21 1/2
X-Small	22 1/4	27 1/2	22
Small	24 1/4	28	22 1/4
Medium	26 1/4	28 1/2	22 1/2
Large	28 1/4	29	22 3/4
X-Large	30 1/4	29 1/2	23
Tolerance	±3/4	±1	±1/2

1/ 1/2 chest measurement taken with the liner flat and the front edges abutting, from folded edge to folded edge at the base of armhole.

2/ Back length measurement taken along center back from edge of neck to bottom edge of liner.

3/ Measure overedged side of backarm seam from top of binding at armhole to bottom of binding at wrist with no tension applied to the seam. The measurement is to be taken at the center portion of the seam allowance.

12-7. RESIZING- Continued

Table 12-3. Trousers Liners, Olive Green, Finished Measurements

	1/2 WAIST <u>1/</u>	INSEAM SHORT & REGULAR <u>2/</u>	INSEAM LONG <u>2/</u>
	INCHES	INCHES	INCHES
X-Small	13 1/2	22	26
Small	15 1/2	22	26
Medium	17 1/2	22	26
Large	19 1/2	22	26
X-Large	21 1/2	22	26
Tolerance	+ 3/4 -1/2	±3/4	±3/4

1/ Measurement taken with the waist buttoned, and the liner laid flat and smooth with elastic relaxed. Measure across front at center of the waistband from side edge to side edge.

2/ Measure along inside seam of liner from end of crotch to bottom leg.

Table 12-4. Trousers Liners, Snow Camouflage, Finished Measurements

SIZE	1/2 WAIST <u>1/</u>	INSEAM SHORT AND REGULAR <u>2/</u>	INSEAM LONG <u>2/</u>
	INCHES	INCHES	INCHES
X-Small	17	23	27 1/4
Small	19	23	27 1/4
Medium	21	23	27 1/4
Large	23	23	27 1/4
X-Large	24	23	27 1/4
Tolerance	±1	±3/4	±1

*1/ Measurement taken with the waist buttoned, and the liner laid flat and smooth with elastic relaxed. Measure across front side edge to side edge on center of waistband.

2/ Measure along Inside seam of liner from end of crotch to bottom of leg.

12-7. RESIZING - Continued

Table 12-5. Desert Night Parka Liner Finished Measurements

SIZE	X-SMALL	SMALL	MEDIUM	LARGE	X-LARGE	TOLERANCE
	INCHES	INCHES	INCHES	INCHES	INCHES	INCHES
1/2 Chest <u>1/</u>	20	22	24	26	28	±3/4
Back Length <u>2/</u>	32	32 1/2	33	33 1/2	34	±3/4
Sleeve Length <u>3/</u>	24	24 1/4	24 1/2	24 3/4	25	±3/4

1/ Measurement shall be taken, with liner flat and front edges abutting, from the folded edge to folded edge at base of armholes.

2/ Measured from top edge at neck to bottom edge along center back.

3/ Measure overedged side of back arm seam from top of overedge stitching at armhole to bottom of sleeve with no tension applied to seam.

12-8. LABELS

Each clothing liner shall have an identification label and a size label or a combination size and identification label conforming to DDD-L-20. The poncho liner shall have an identification label only. Repair or remark original labels to provide the required information. Replace labels which cannot be repaired with new ones located adjacent to or sewn over old label. The identification label shall conform to Type I, Class 1, of DDD-L-20. The size label shall conform to Type I, Class 2 or DDD-L-20.

a. Instruction labels shall contain the following information:

LINER, WET WEATHER PONCHO

1. Spread the poncho flat on the ground, making sure that the hood opening is tightly closed and is on the groundside.
2. Place liner on poncho, matching the tie laces on liner with the grommets on the poncho and tie together.
3. If the poncho and liner combination is to be used as a sleeping bag, snap the sides of the poncho together along their entire length and tuck the foot end under to keep the feet from sticking out.

CAUTION

Do not fasten the snap fasteners together when used as a sleeping bag in combat areas; it cannot be opened quickly.

4. Poncho and liner combination can be used as a wrap-around sleeping bag or as a blanket.
5. The liner, without the poncho, can be used as a blanket when sleeping under cover or in a jungle hammock.
6. Keep liner away from open fire and sparks. DO NOT SMOKE in bed when using liner as a blanket or sleeping bag.
7. When necessary, liner can be hand laundered. Use a mild soap and LUKEWARM water. Do not boil.
8. Do not dry clean.

12-8. LABELS - Continued

LINER, EXTREME COLD WEATHER, PARKA

1. Button into parka for extra warmth.
2. Dry liner and parka separately when damp or wet.
3. Avoid contact with heated stoves, open fires, or other heat sources; fabric may fuse.
4. Wash by hand or machine in warm water with mild soap or detergent, rinse thoroughly and drip or machine dry. DO NOT DRY CLEAN.

DO NOT REMOVE THIS LABEL

LINER, COLD WEATHER COAT

1. For extra warmth, button into coat, cold weather, field, or wear as a separate garment in the parka, cold weather, camouflage.
2. Dry liner and coat separately when damp or wet.
3. Avoid contact with heated stoves, open fires, or other heat sources; fabric may fuse.
4. Wash by hand or machine in warm water with mild soap or detergent, rinse thoroughly, and drip dry to tumble dry, medium setting. DO NOT DRY CLEAN.

DO NOT REMOVE THIS LABEL

LINER, COLD WEATHER TROUSERS, FIELD

1. Button into trousers for extra warmth.
2. Buttoning side openings for easy removal.
3. Dry liner and trousers separately.
4. Avoid contact with heated stoves, open fires, or other heat sources; fabric may fuse.
5. Wash by hand or machine in warm water with mild soap or detergent, rinse thoroughly, and drip dry or machine dry.

DO NOT REMOVE THIS LABEL

LINER, SNOW, CAMOUFLAGE TROUSERS, ARCTIC, M-65

Button into camouflage trousers for extra warmth.
 Dry liner and camouflage trousers separately when damp or wet.
 Avoid contact with heated stoves, open fires, or other heat sources. Fabric may fuse.
 Wash by hand or machine in warm water with mild soap or detergent, rinse thoroughly and drip or machine dry. DO NOT DRY CLEAN.

DO NOT REMOVE THIS LABEL

LINER, NIGHT CAMOUFLAGE PARKA: DESERT

1. Button Into parka for extra warmth.
2. Dry liner and parka separately when damp or wet.
3. Avoid contact with heated stoves, open fires, or other heat sources; fabric may fuse.
4. Wash by hand or machine in warm water with mild soap or detergent, rinse thoroughly and drip or machine dry. DO NOT DRY CLEAN.

DO NOT REMOVE THIS LABEL.

12-8. LABELS- Continued

- b. The parka size label shall contain the following information:

X-Small

Liner, Extreme Cold Weather
 Chest: Under 33 inches
 Stock No. 8415-00-782-2881
 NATO Size: 7080/7484

Small

Liner, Extreme Cold Weather
 Chest: From 33 to 37 inches
 Stock No. 8415-00-782-2882
 NATO Size: 7080/8494

Medium

Liner, Extreme Cold Weather
 Chest: From 37 to 41 inches
 Stock No. 8415-00-782-2883
 NATO Size: 7080/9404

Large

Liner, Extreme Cold Weather
 Chest: From 41 to 45 inches
 Stock No. 8415-00-782-2884
 NATO Size: 7080/0414

X-Large

Liner, Extreme Cold Weather
 Chest. From 45 inches and upward
 Stock No 8415-00-782-2885
 NATO Size: 7080/1424

- c. The cold weather coat liner size label shall contain the following information:

X-Short - X-Small

Liner Cold Weather Coat
 Height: Up to 63 inches
 Chest Men's: Up to 33 inches
 Chest Women's: Up to 36 inches
 Stock No. 8415-01-062-0679
 NATO Size: 5060/7484

X-Short - Small

Liner Cold Weather Coat
 Height: Up to 63 inches
 Chest Men's: 33 to 37 inches
 Chest Women's: 36 to 40 inches
 Stock No. 8415-01-062-0680
 NATO Size: 5060/8494

X-Short - Medium

Liner Cold Weather Coat
 Height: Up to 63 inches
 Chest Men's: 37 to 41 inches
 Chest Women's: 40 to 44 inches
 Stock No. 8415-01-062-0681
 NATO Size: 5060/9404

X-Small

Liner Cold Weather Coat
 Height: Over 63 inches
 Chest Men's: Up to 33 inches
 Chest Women's: Up to 36 Inches
 Stock No. 8415-00-782-2886
 NATO Size: 7080/7484

Small

Liner Cold Weather Coat
 Height: Over 63 inches
 Chest Men's: 33 to 37 inches
 Chest Women's: 36 to 40 inches
 Stock No. 8415-01-782-2887
 NATO Size: 7080/8494

Medium

Liner Cold Weather Coat
 Height: Over 63 inches
 Chest Men's: 37 to 41 inches
 Chest Women's: 40 to 44 inches
 Stock No. 8415-00-782-2888
 NATO Size: 7080/9404

12-8. LABELS - Continued

Large

Liner Cold Weather Coat
 Height: Over 63 inches
 Chest Men's: 41 to 45 inches
 Stock No. 8415-00-782-2889
 NATO Size: 7080/0414

X-Large

Liner Cold Weather Coat
 Height: Over 63 inches
 Chest Men's: Over 45 inches
 Stock No. 8415-00-782-2890
 NATO Size: 7080/1424

d. Liner, cold weather trousers, field size label shall contain the following information:

X-Small - Short and Regular

Liner, Cold Weather Trousers Field
 Waist: Below 27 inches
 Inseam: Up to 32 1/2 inches
 Stock No. 8415-01-180-0370
 NATO Size: 6783/5869

X-Small - Long

Liner, Cold Weather Trousers Field
 Waist: Below 27 inches
 Inseam: Over 32 1/2 Inches
 Stock No.
 NATO Size: 8390/5869

Small - Short and Regular

Liner, Cold Weather Trousers Field
 Waist: From 27 to 37 inches
 Inseam: Up to 32 1/2 inches
 Stock No. 8415-01-180-0371
 NATO Size: 6783/6979

Small - Long

Liner, Cold Weather Trousers Field
 Waist: From 27 to 31 inches
 Inseam: Over 32 1/2 inches
 Stock No. 8415-01-180-0372
 NATO Size: 8390/6979

Medium - Short and Regular

Liner, Cold Weather Trousers Field
 Waist: From 31 to 35 inches
 Inseam: Up to 32 1/2 inches
 Stock No. 8415-01-180-0373
 NATO Size: 6783/7989

Medium - Long

Liner, Cold Weather Trousers Field
 Waist: From 31 to 35 inches
 Inseam: Over 32 1/2 inches
 Stock No. 8415-01-180-0374
 NATO Size: 8390/7989

12-8. LABELS - Continued

Large - Short and Regular

Liner, Cold Weather Trousers Field
 Waist: From 35 to 39 inches
 Inseam: Up to 32 1/2 inches
 Stock No. 8415-01-180-0375
 NATO Size: 6783/8999

Large - Long

Liner, Cold Weather Trousers Field
 Waist: From 35 to 39 inches
 Inseam: Over 32 1/2 inches
 Stock No. 8415-01-180-0376
 NATO Size: 8390/8999

X-Large - Short and Regular

Liner, Cold Weather Trousers Field
 Waist: From 39 to 43 inches
 Inseam: Up to 32 1/2 inches
 Stock No. 8415-01-180-0377
 NATO Size: 6783/9909

X-Large - Long

Liner, Cold Weather Trousers Field
 Waist: From 35 to 43 inches
 Inseam: Over 32 1/2 inches
 Stock No.
 NATO Size: 8390/9909

- e. The snow camouflage trousers size label shall contain the following information:

X-Small - Short and Regular

Liner, Snow Camouflage Trousers, White,
 Arctic, M-65
 Waist: Below 27 inches
 Inseam: Up to 32 1/2 inches
 Stock No. 8405-00-935-0546
 NATO Size: 6783/5869

X-Small - Long

Liner, Snow Camouflage Trousers, White,
 Arctic, M-65
 Waist: Below 27 inches
 Inseam: Over 32 1/2 inches
 Stock No.
 NATO Size: 8390/5869

Small - Short and Regular

Liner, Snow Camouflage Trousers, White,
 Arctic, M-65
 Waist: From 28 to 31 inches
 Inseam: Up to 32 1/2 inches
 Stock No. 8405-00-935-0547
 NATO Size: 6783/6979

Small - Long

Liner, Snow Camouflage Trousers, White,
 Arctic, M-65
 Waist: From 27 to 31 inches
 Inseam: Over 32 1/2 inches
 Stock No. 8405-00-935-0548
 NATO Size: 8390/6979

12-8. LABELS- Continued

Medium - Short and Regular

Liner, Snow Camouflage Trousers, White,
Arctic, M-65
Waist: From 31 to 35 inches
Inseam: Up to 32 1/2 inches
Stock No. 8405-00-935-0549
NATO Size: 6783/7989

Medium - Long

Liner, Snow Camouflage Trousers, White,
Arctic, M-65
Waist: From 31 to 35 inches
Inseam: Over 32 1/2 inches
Stock No. 8405-00-935-0550
NATO Size: 8390/7989

Large - Short and Regular

Liner, Snow Camouflage Trousers, White,
Arctic, M-65
Waist: From 35 to 39 inches
Inseam: Up to 32 1/2 inches
Stock No. 8405-00-935-0551
NATO Size: 6783/8999

Large - Long

Liner, Snow Camouflage Trousers, White,
Arctic, M-65
Waist: From 35 to 39 inches
Inseam: Over 32 1/2 inches
Stock No. 8405-00-935-0552
NATO Size: 8390/8999

X-Large - Short and Regular

Liner, Snow Camouflage Trousers, White,
Arctic, M-65
Waist: From 39 to 43 inches
Inseam: Up to 32 1/2 inches
Stock No. 8405-00-935-0553
NATO Size: 6783/9909

X-Large - Long

Liner, Snow Camouflage Trousers, White,
Arctic, M-65
Waist: From 39 to 43 inches
Inseam: Over 32 1/2 inches
Stock No.
NATO Size: 8390/9909

- f. The desert parka liner size label shall contain the following information:

X-Small

Liner, Night Camouflage Parka: Desert
Chest: Up to 33 inches
Stock No. 8415-01-102-4481
NATO Size: 7080/7484

Small

Liner, Night Camouflage Parka: Desert
Chest: 33 to 37 inches
Stock No. 8415-01-102-4482
NATO Size: 7080/8494

12-8. LABELS - Continued**Medium**

Liner, Night Camouflage Parka: Desert
Chest: 37 to 41 Inches
Stock No. 8415-01-102-4483
NATO Size: 7080/9404

Large

Liner, Night Camouflage Parka: Desert
Chest: 41 to 45 inches
Stock No. 8415-01-102-4484
NATO Size: 7080/0414

X-Large

Liner, Night Camouflage Parka: Desert
Chest: From 45 inches and upward
Stock No. 8415-01-102-4485
NATO Size: 7080/1424

12-9. WORKMANSHIP

All work shall be accomplished by personnel skilled in the particular trade applicable to their duties in the repair of clothing. Patches will be tightly sewn and all reseaming will be secure and free of loose or broken thread. Buttons will be securely and properly attached. The finished garment shall be complete, clean, and well repaired, and free from all defects affecting its serviceability and appearance.

12-10. INSPECTION

The inspection or quality control unit is responsible for determining compliance with repair instructions and requirements for classification. In-process inspections will be performed for quality of workmanship and correct application of repair procedures. The completed garment will be inspected for serviceable condition and appearance to insure against return of substandard product to supply channels.

Section III. MATERIALS - Continued

(1) SMR CODE	(2) NATIONAL STOCK NUMBER	(3) DESCRIPTION	(4) UNIT OF ISSUE	USED ON
XBFZZ		Batting, QUILTED, POLYESTER, Type III, Class 1, Style a, MIL-B-41826. Source of Supply; Cannibalize.	YD	All liners
XBFZZ		CLOTH, RIPSTOP NYLON, Class 1 or Class 3, MIL-C-43637. Source of Supply: Cannibalize	YD	Poncho Liner Cover
PAFZZ	8305-00-261-8140	CLOTH, OXFORD, NYLON, Olive green shade 106, MIL-C-508, for facing and binding.	YD	Coat, trousers, and parka liners.
PAFZZ	8315-00-641-8328	BRAID, TEXTILE, tubular nylon, olive green shade 7, V-L-61	YD	Poncho tie tapes
PAFZZ	8310-00-244-0603	THREAD, NYLON, olive drab shade 66022 (S-1), 3 ply, Ticket A. V-T-295, Type I, Class A	TU	Coat, trousers, and parka liners.
PAFZZ	8310-00-244-0602	THREAD, NYLON, olive drab shade 66022 (S-1), 2 ply, Ticket B. V-T-295, Type I, Class A	SL	All liners.
PAFZZ	8310-00-262-0096	THREAD COTTON GIMP olive drab shade 66022 (S-1), 3 ply, ticket 8. V-T-280, Type I	SL	Coat, trousers, parka liners.
PAFZZ	8315-00-899-0029	BUTTON, SEWING HOLE, olive green shade 62016 (BP) style 26 V-B-871, Type II	GR	Trouser liners.

CHAPTER 13

**MAINTENANCE OF COATED NYLON PONCHO AND MEN'S COTTON AND POLYESTER/
POPLIN RAINCOAT**

Section I. INTRODUCTION

13-1. SCOPE

This chapter provides instructions that cover the materials, methods, and the repair of coated nylon ponchos and men's cotton polyester raincoats.

13-2. COMMODITY SPECIFICATIONS

a. Items.

SPECIFICATION	ITEM
M I L-P-3003	Poncho, Heavy Duty with Hood (Vinyl Coated)
MIL-R-43518	Raincoat, Man's, Quarpel

b. Components.

SPECIFICATION	ITEM
V-B-871	Button, Sewing Hole, and Button, Staple (Plastic)
V-T-276	Thread, Cotton
V-T-280	Thread, Cotton Gimp, Buttonhole
V-T-285	Thread, Polyester
CCC-C-438	Cloth, Buckram, Cotton
DDD-L-20	Label for Clothing, Equipage & Tentage (General Use)
MIL-B-371	Braid, Textile, Tubular
MIL-B-1860	Buckle, Slide, Plastic
MIL-T-3530	Thread and Twine, Mildew Resistant
MIL-F-10884	Fasteners, Snap
MIL-G-16491	Grommet, Metallic
MIL-C-40039	Cloth, Coated, Nylon, Vinyl Coated

13-2. COMMODITY SPECIFICATIONS-Continued

SPECIFICATION	ITEM
MIL-C-43482	Cloth, Poplin, Cotton and Polyester (Quarapel Treated)
MIL-L-5024	Talc, Powder

13-3. TECHNICAL PUBLICATIONS

NUMBER	TITLE
M IL-STD-665 MIL-STD-666 FM 10-300	Laundering of Clothing and Equipage Dry Cleaning of Clothing and Equipage Military Fixed Dry Cleaning Plant

13-4 IDENTIFICATION AND DESCRIPTION

- a. Poncho, Heavy Duty with hood; vinyl coated, OG 207. The vinyl coated heavy duty poncho (NSN 8405-00-290-0550) is fabricated from a 1 6 ounce per square yard (54.3 gram per square meter) nylon twill fabric coated on both sides with a thermoplastic vinyl chloride coating. The poncho measures 92 inches (233.7 cm) long by 66 inches (167.6 cm) wide and weighs approximately 2 pounds 11 ounces (0.76 kg). The ends are curved and the neck is positioned forward of the center line of the poncho. The hood is hemmed and fitted with a drawcord and slide keeper. A drawcord is located at the waist to allow front length adjustment. The outside of the poncho is finished with hems or separate facings, fitted with grommets and snap fasteners (fig. 13-1).
- b. Raincoat, man's, cotton and polyester/poplin quarpel treated. AG274, NSN 8405-00-965-2145 through 8405-00-965-2171. The raincoat is of six button, double-breasted design with lapel collar, shoulder loops, and sleeve tabs. It has an all-around belt with plastic slide buckle, inside hanging-slash pockets, with center vent (fig. 13-2).

13-4. IDENTIFICATION AND DESCRIPTION-Continued

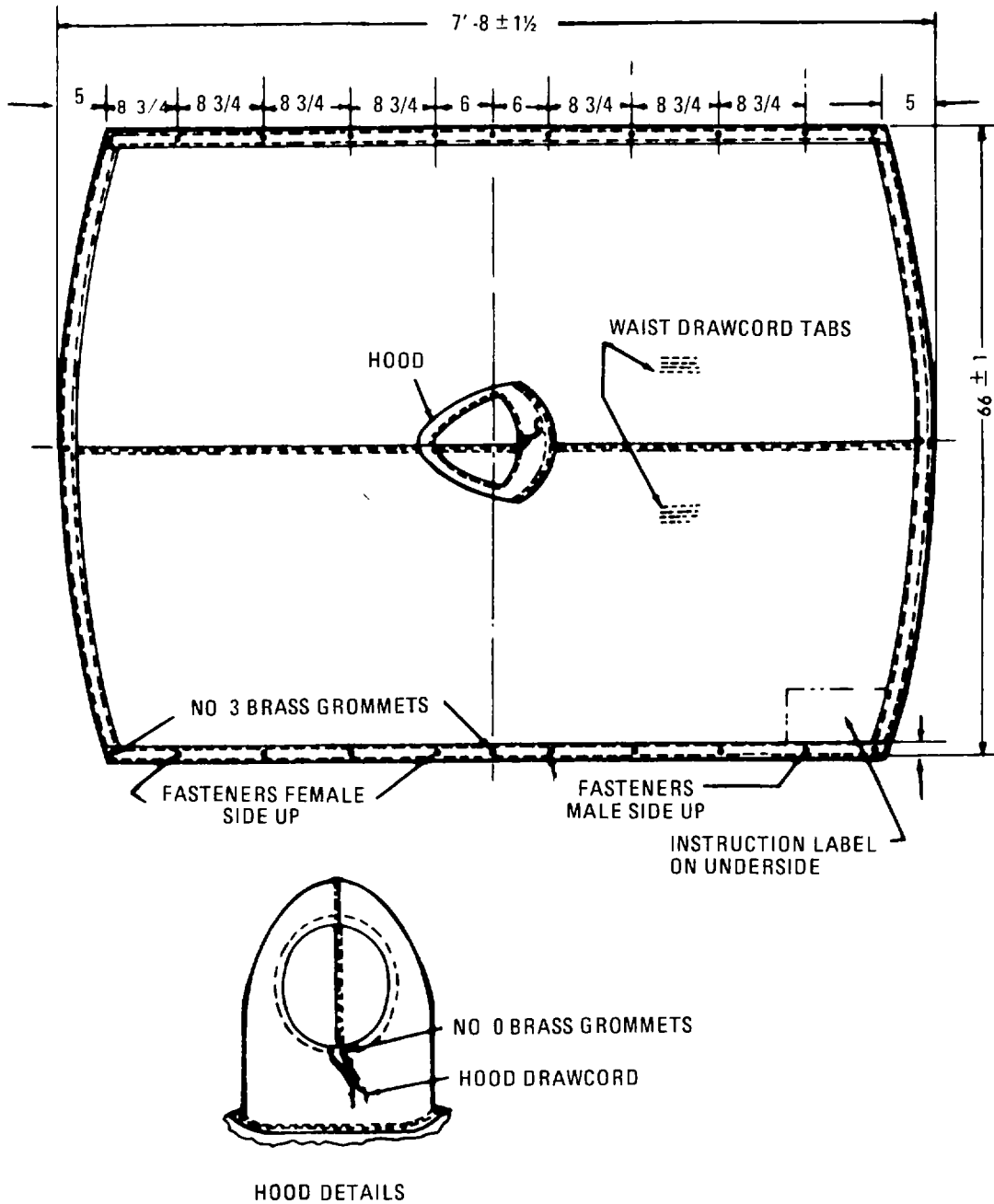

Figure 13-1. Poncho, coated nylon, olive green shade 207, heavy duty MIL-P-3033.

13-4. IDENTIFICATION AND DESCRIPTION-Continued

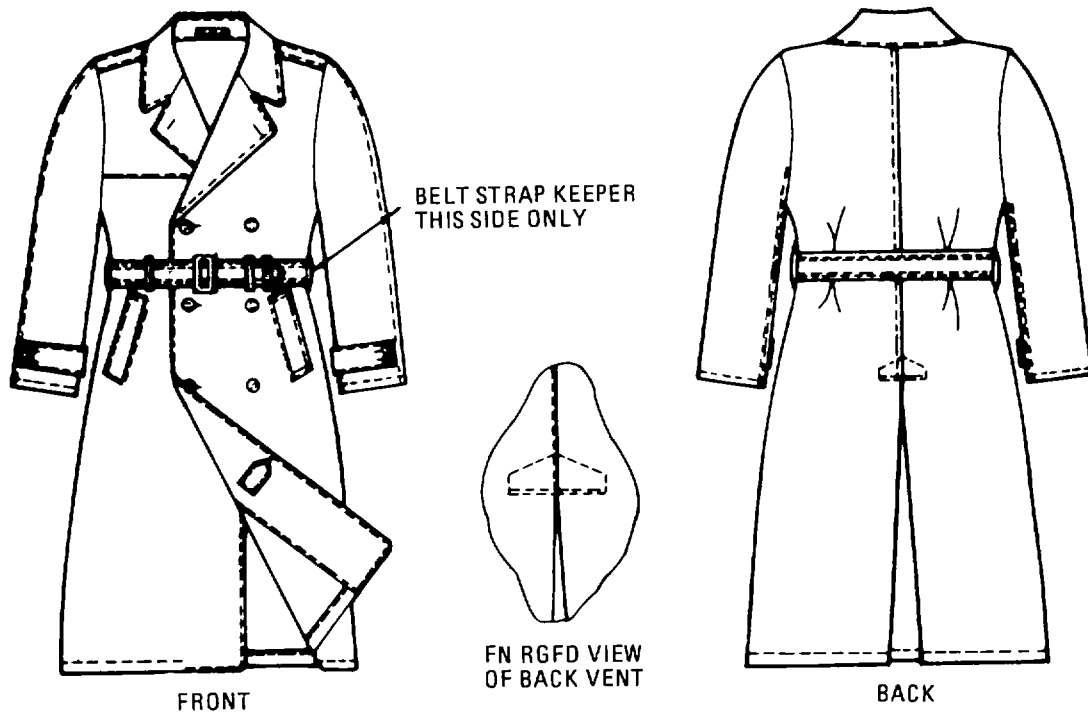

Figure 13-2. Raincoat, man's cotton and nylon, AG274.

Section II. REPAIR PROCEDURES

13-5. MATERIALS

Materials used in the repair of ponchos and raincoats will be serviceable materials recovered from similar salvaged items, when authorized or will be new materials as specified in Section III.

13-6. CLASSIFICATION I

Refer to chapter 1 for serviceability classification for the poncho and raincoat.

13-7. REPAIR AND MAINTENANCE

Prior to repair, each item will be inspected to determine the amount of repair necessary. Repairs will be made as fully as skills, facilities, funds and local conditions permit.

- a. Repair procedure for the vinyl coated ponchos.

- (1) Patching and Maintenance.

- (a) Cleaning. Do not machine wash or machine dry the poncho. Wipe soiled ponchos with a clean cloth, shampoo by hand with a soft bristle brush using warm water and a mild soap synthetic detergent, and rinse thoroughly. Air dry the ponchos, do not use direct heat, as this will cause the coated material to dry out and crack.

NOTE

Do not use a cleaning fluid on vinyl coated fabric.

- (b) Patching material.

1. Patching material shall be as specified in Section III. Select a piece or pieces of patching material of sufficient size to provide the desired number of patches for application on a given day. This material shall be given a full coat of tent patching cement on the heavily coated (smoother) side. The cement shall be allowed to dry until the piece or pieces will permit cutting without fouling of the shears with cement (about 1 hour).
 2. The cement-coated pieces shall be cut into patches of the desired sizes. Patches shall be large enough to cover the given damage (tear or wear-through) area and overlap it at least 1/2 Inch (1.30 cm) in all directions.

NOTE

Corners of the patch shall be rounded.

13-7 REPAIR AND MAINTENANCE-Continued

(c) Patching

1. The area to be patched and the patching material must be clean and dry.
 2. Each patch shall be placed in the desired final position and a ball point pen tracing made of its entire border. The patch shall be removed and a coat of tent patching cement applied within the traced area. Allow cement to dry approximately 10 minutes.
 3. Carefully press the patch in place. The poncho may be handled and folded immediately.
- (2) Stitching and restitching. Machine sew all items being repaired except in emergency repair. Backstitch all stitching at ends to prevent raveling. Properly maintain thread tension to prevent loose stitching. Use same stitching space, and type of seams as that of original construction. Restitch all seams having loose and/or weak thread. Overstitch thread breaks in double lock stitching (type 401) not less than 1/2 inch (1.30 cm) at each break. For information on the various stitch types used, see Federal Standard 751. Thread sizes are found in Section III.
- (3) Drawcords. Replace missing, frayed, or otherwise defective drawcords cut from braid. Dip the ends of the drawcords in a suitable synthetic resin or tip with nonflammable plastic to prevent fraying.

Cord for hood	46 inches (116.8 cm)
---------------	----------------------

- (4) Hardware. Straighten bent and damaged hardware that is otherwise serviceable. Replace hardware such as keepers, eyelets, and snaps that are missing or damaged beyond repair. Retouch or refinish hardware as required. Thoroughly clean hardware of rust, corrosion, dirt or other foreign matter. Exercise care in replacing or inserting eyelets and fasteners so as not to damage material. Tightly clinch the eyelets without splitting. Tightly clinch fasteners.
- (5) Sealing of Seams. Apply seam sealant by brush on the stitching and needle holes and under the turned edges of all restitched seams. Allow each coat to become dry to touch before applying the subsequent coat. All restitching, except the peripheral hems and the facing piece seams around the face opening of the hood, shall be sealed on the inside of the poncho with a minimum of three coats. Seal outside areas with a minimum of one coat of sealant, except that the earphone cover joining seam and hem shall not be sealed on the outside. Restitched hems and facing piece seams around the face openings of the hood shall not be sealed. The coats of sealant shall be allowed to dry before the ponchos are folded or before sealed surfaces are allowed to contact other parts of the garment. Adequacy of the drying time may be determined by unfolding a poncho which has been folded and stored for one hour. When the coats of sealant are dry, the sealed seams shall be dusted thoroughly with talc. Use sealant prescribed for ponchos in Section III.

13-7. REPAIR AND MAINTENANCE-Continued

- (6) Marking. Where the original instruction marking has become illegible, the following information will be clearly printed with black marking ink on the underside of the poncho in letters 1/4 inch (0.635 cm) high:
- MULTIPURPOSE PONCHOS
- Rain garment and ground sheet
 - Blanket or sleeping bag cover (snap the two long edges together)
 - Tent (Snap two ponchos together as side walls)
 - Floor (third poncho will snap inside tent as a floor)
 - Two open tents will go end to end with common center pole

b. Repair procedure for the raincoat.

- (1) Cleaning. Raincoats will be processed in Army laundry and/or cleaning facilities in accordance with established practices prescribed in FM 10-280 and the procedures contained on the garment label. When such facilities are not available, raincoats will be laundered and/or drycleaned by contract with private industry in accordance with the practices and procedures prescribed above for military facilities. Spots and stains easily discernible at a casual glance will not be permitted. Laundering is the preferred method of cleaning.
 - (2) Patching and darning. Patches and darns which would be visible on the raincoat when worn are not permitted.
 - (3) Buttons. Replace missing buttons by machine using appropriate matching buttons. Where buttons are torn out, repair torn area per paragraph 13(3) of FM 10-16 so long as repair is not visible when raincoat is worn.
 - (4) Buttonholes. Reshape enlarged buttonholes by securely tacking the ends of proper fit over corresponding buttons. Repair damaged buttonholes by stitching.
 - (5) Belt loops, belt keeper, hanger and sleeve tabs. Replace or re sew missing or loose belt loops, belt keeper, hanger and sleeve tabs with matching material.
 - (6) Pockets. Remove pocket linings that are badly damaged. Fabricate new linings from basic material.
 - (7) Buckle. Replace damaged or broken buckles. After removing stitches and damaged buckle, thread straight end of belt through buckle, fold back $2\text{-}3/4 \pm 1\text{-}1/4$ inches (6.99 ± 3.18 cm) turn under the raw edge and stitch with two rows of stitching adjacent to each other $1\text{-}1/16$ to $1/8$ inch (2.70 to 0.318 cm) from edge.
 - (8) Stitching and restitching. Machine sew raincoats being repaired except in emergency repair. Backstitch all stitching at ends to prevent raveling. Properly maintain thread tension to prevent loose stitching. Use same stitching space and type of seams as that of original construction. Restitch all seams having loose and/or weak thread. Over-stitch thread breaks in double lock stitching, (type 401) not less than 1/2 inch (1.30 cm) at each break. Where stitch type 401 is used, the looper, that is the under thread, shall be on the inside of the coat. Skipped stitches of thread breaks on stitch type 401 may be repaired by using 301 stitch type.
-

13-7. REPAIR AND MAINTENANCE-Continued

- (9) Stitching table. The following thread sizes, stitches per inch, and types of stitch (as illustrated in Federal Standard 751) will be used where stitching is required. Refer to table 13-1 for stitching instructions.
- (10) Labels. Each raincoat shall have an identification label, an instruction label and a size label conforming to DDD-L-20. The labels shall show fasteness to laundering.
- (a) The identification label shall conform to Type I, Class 1 of DDD-L-20. Caption to read:
- RAINCOAT, MAN'S COTTON & POLYESTER, QUARPEL, AG274
- (b) The size label shall conform to Type I, Class 2 of DDD-L-20. Caption to include:
- one description term, e g "Regular"
one size numeric, e.g. "40"
- (c) The instruction label shall conform to Type I, Class 3 of DDD-L-20 and contain the following Information:
- LAUNDERING (PREFERRED METHOD)
- Spot wash badly soiled areas
Wash in hot water (140°F (60°C)) using detergent
Rinse at least 3 times
Machine spin or squeeze by hand
Machine dry at moderate heat (not to exceed 160°F (71.1°C)) or hang to dry
Press with moderately hot Iron (synthetic setting)
- DRY CLEANING (ALTERNATE.METHOD)
- Dry cleaning in "Pure" solvent will not reduce water resistance nor will dry cleaning with detergent, providing the detergent is removed by rinsing.
- If poor water resistance is noted after cleaning, rinsing in water followed by drying and pressing will renew water resistance.
- (11) Resizing and federal stock numbers. Resize raincoats according to schedule of sizes and National Stock numbers listed in table 13-2 after cleaning and repairs have been accomplished. When garments vary in size from original marking, obliterate old marking and mark proper size with indelible pencil or waterproof ink. When the measurements do not correspond to a size listed, relabel to nearest breast and back length. Raincoats in good wearable condition should not be sent to property disposal because measurements are off fractions of an Inch. Relabel to next lower size.
-

13-7. REPAIR AND MAINTENANCE-Continued

Table 13-1. Stitching Instructions

OPERATION	STITCH TYPE	THREAD		STITCHES PER INCH
		NEEDLE	BOBBIN	
General	301 or 401	50-3 50-3	50-3 70-2	9-11
Buttonhole	Buttonhole	30-3	50-3	50-52 per buttonhole
Button	301	50-3	50-3	14-16 per button
	101	50-3		14-16 per button
	Hand	50-3		4-6 double
Bartack	Bartack	30-3	30-3	28 per bartack

13-7. REPAIR AND MAINTENANCE-Continued

Table 13-2. Sizing Instructions and Finished Measurements (In Inches)

SIZE	1/2 BREAST ¹	SLEEVE LENGTH ²	BACK LENGTH ³	BELT LENGTH ⁴	NATIONAL STOCK NO.
Short					
34	20-7/8	18	43-5/8	44-1/2	8405-00-965-2145
36	21-7/8	18	43-7/8	46-1/2	8405-00-965-2148
38	22-7/8	18	44-1/8	48-1/2	8405-00-965-2152
40	23-7/8	18	44-3/8	50-1/2	8405-00-965-2156
42	24-7/8	18	44-5/8	52-1/2	8405-00-965-2160
44	25-7/8	18	44-7/8	54-1/2	8405-00-965-2164
46	26-7/8	18	45-1/8	56-1/2	
Regular					
34	20-7/8	19	45-7/8	44-1/2	8405-00-965-2146
36	21-7/8	19	46-1/8	46-1/2	8405-00-965-2149
38	22-7/8	19	46-3/8	48-1/2	8405-00-965-2153
40	23-7/8	19	46-5/8	50-1/2	8405-00-965-2157
42	24-7/8	19	46-7/8	52-1/2	8405-00-965-2161
44	25-7/8	19	47-1/8	54-1/2	8405-00-965-2165
46	26-7/8	19	47-3/8	56-1/2	8405-00-965-2168
48	27-7/8	19	47-5/8	58-1/2	8405-00-965-2171
Long					
34	20-7/8	20	48-1/8	44-1/2	8405-00-965-2147
36	21-7/8	20	48-3/8	46-1/2	8405-00-965-2150
38	22-7/8	20	48-5/8	48-1/2	8405-00-965-2154
40	23-7/8	20	48-7/8	50-1/2	8405-00-965-2158
42	24-7/8	20	49-1/8	52-1/2	8405-00-965-2162
44	25-7/8	20	49-3/8	54-1/2	8405-00-965-2166
46	26-7/8	20	49-5/8	56-1/2	8405-00-965-2169
48	27-7/8	20	49-7/8	58-1/2	
Extra Long					
36	21-7/8	21	50-7/8	46-1/2	8405-00-965-2151
38	22-7/8	21	51-1/8	48-1/2	8405-00-965-2155
40	23-7/8	21	51-3/8	50-1/2	8405-00-965-2159
42	24-7/8	21	51-5/8	52-1/2	8405-00-965-2163
44	25-7/8	21	51-7/8	52-1/2	8405-00-965-2167
46	26-7/8	21	52-1/8	56-1/2	8405-00-965-2170
48	27-7/8	21	52-1/8	56-1/2	

Tolerance

Plus	1/2	1/2	1/2	1
Minus	1/2	1/2	1/2	1

¹ One half breast measurement taken with coat buttoned from folded edge to folded edge in line with pit or armhole.

² Sleeve length measurements taken along inseam from pit of armhole to bottom of sleeve.

³ Back length measurement taken along center seam from under collar seam to bottom.

⁴ Belt measurement shall be taken from point of finished belt to fold at buckle bar.

Section III. MATERIALS - Continued

(1) SMR CODE	(2) NATIONAL STOCK NUMBER	(3) DESCRIPTION	(4) UNIT OF ISSUE
XBFZZ		<p style="text-align: center;">PONCHO, HEAVY DUTY (VINYL COATED)</p> <p>Cloth, Nylon, Vinyl Coated: Conform to MIL-C-40039 Sources of Supply: (1) Reeves Bros., Inc. 1071 Avenue of the Americas New York, NY 10018 (2) Bond Cote of Virginia, Inc. PO.Box 729 Burgis Avenue Pulaski, VA 24301 (3) Cannibalize From Unreparable Items.</p>	
PAFZZ	8310-01-066-0973	Thread; Conform Type IA3, Ticket No. 50, 3 Ply, Shade S-1, Cable No. 66022 of V-T-276	SL
PAFZZ	5325-00-202-2054	Grommets, Brass; Size 0 to 3; Conform to Type II, Class 3 of MIL-G-16491	GR
PAFZZ	5325-00-202-4385	Grommets, Brass; Size 3; Conform to Type II, Class 3 of MIL-G-16491	GR
PAFZZ	5325-00-290-5930	Fastener, Snap; Socket Conform to MIL-F-10884	EA
PAFZZ	5325-00-292-5343	Fastener, Snap; Stud Eyelet, Size 1 or 2 MIL-F-10884, Style A, Class 2	HD
PAFZZ	8315-00-267-3125	Braid, OG 107, Conform to Type IV, Class 2 of MIL-B-371; 0.125 inch Dia	YD
XBFZZ		Keeper, Slide; Rectangular Plastic Keeper, OD 7 Measure 1 ¼ x ¾ x 1/8 inch, With Two ¼ Inch Holes. Salvage From Unreparable Items	EA
PAFZZ	7510-00-234-7960	Tape, Pressure Sensitive Adhesive; 3M Scotch Brand, P/N 600, 2 inch Source of Supply: (1) Local GSA Supply Point (2) Minnesota Mining and Mfg. Co., Packaging Systems Division 3M Center St. Paul, Minnesota, 55144-3861 (FSCM 52170).	PL

Section III. MATERIALS - Continued

(1) SMR CODE	(2) NATIONAL STOCK NUMBER	(3) DESCRIPTION	(4) UNIT OF ISSUE
XBFZZ		Sealant, Seam; Pigmented Solvent Solution of Polymerized or Copolymerized Virgin Vinyl Chloride Resin Utilizing Either a Phosphate or Pathalate Ester Type Plasticizer Only. Color Should Match Basic Cloth Sources of Supply: (1) Reeves Bros., Inc. 1071 Avenue of the Americas New York, NY 10018 (2) Bond Cote of Virginia, Inc. P.O.Box 729 Burgis Avenue Pulaski, VA 24301 Local Procurement	
PCOZZ	8040-00-266-0850	Adhesive, MIL-C-2399	PT
PAOZZ	2640-00-264-6642	Lubricant; Talc 50%, Mica 50%, 443 (79899)	BX
RAINCOAT, MAN'S QUARPEL			
XBFZZ		Cloth, Cotton & Polyester Poplin; Conform to MIL-C-43482	YD
PAFZZ	8310-00-066-0973	Thread, Polyester Core, Cotton-Rayon or Polyester Covered, Olive Drab, Part No. MIL-T-43548 (81349), 50/3 Ply	CE
PAFZZ	8310-00-262-0096	Thread Gimp, Cotton; Conform to Type I, Size No. 8 of V-T-280	SL
PAFZZ	8315-00-105-6376	Buckle, Slide, Plastic; Conform to Class 3 of MIL-B-1860	EA
PAOZZ	8315-00-103-2476	Buttons, Sewing Hole, Stay; Style 15, 18 Line; Conform to Type II, Class D of V-B-871	GR
PAOZZ	8315-00-042-7287	Buttons, Sewing Hole, Shoulder Loops, Storm Tab, Belt Strap, Front Shield & Sleeve Tab; Style 20/21; 24 Line; Conform to Type II, Class D of V-B-871	GR
PAOZZ	8315-00-042-7291	Button, Sewing Hole, Front Closure; Style 20/21; 45 Line; Conform to Type II, Class D of V-B-871	GR

CHAPTER 14

MAINTENANCE OF MEN'S SERVICE SHIRTS

Section I. INTRODUCTION

14-1. SCOPE

This chapter provides instructions that cover the materials, methods, and procedures for the repair and maintenance of men's AG 415 polyester/cotton shirts.

14-2. COMMODITY SPECIFICATIONS

a. Items.

SPECIFICATION	ITEM
MIL-S-44039	Shirt, Man's, Long Sleeve, Polyester/ Cotton, Green 415, Durable Press
MIL-S-44041	Shirt, Man's, Short Sleeve, Polyester/ Cotton, Green 415, Durable Press

b. Components.

SPECIFICATION	ITEM
V-B-871	Button, Sewing Hole, and Button, Staple, Plastic
MI L-T-43548	Thread, Polyester, Cotton-Covered
M IL-C-43594	Cloth, Interlining, Polyester
MI L-T-43624	Thread, Polyester, Spun
MIL-C-43992	Cloth, Broadcloth, Polyester/Cotton, Durable Press
MIL-P-55010	Plastic Sheet, Polyethylene Terephthalate

14-3. TECHNICAL PUBLICATIONS

NUMBER	TITLE
FM 10-280	Field Laundry, Bath and Clothing Exchange Operations

14-4. IDENTIFICATION AND DESCRIPTION

- a. Shirt, Man's, Long Sleeve, Polyester/Cotton, Green 415, Durable Press (fig 14-1).

NSN	NECK SIZE	SLEEVE LENGTH
8405-01-077-5012 to 5014	13 ½	30 to 32
8405-01-077-5015 to 5020	14	29 to 34
8405-01-077-5021 to 5026	14 ½	30 to 35
8405-01-077-5027 to 5034	15	30 to 37
8405-01-077-5035 to 5043	15 ½	30 to 38
8405-01-077-5044 to 5051	16	31 to 38
8405-01-077-5052 to 5059	16 ½	31 to 38
8405-01-077-5060 to 5064	17	33 to 37
8405-01-077-5065 to 5066	17 ½	33 & 35

The shirts are fabricated from polyester/cotton broadcloth conforming to MIL-C-43992. The shirt is a long sleeve dress style with a standup collar, seven button front, two breast pockets with button through flaps, pen pocket inside the left breast pocket, and shoulder loops

- b. Shirt, Man's Short Sleeve, Polyester/Cotton, Green 415, Durable Press (fig. 14-2).

NUMBER	TITLE
8405-01-077-2955	13 ½
8405-01-077-2956	14
8405-01-077-2957	14 ½
8405-01-077-2958	15
8405-01-077-2959	15 ½
8405-01-077-2960	16
8405-01-077-2961	16 ½
8405-01-077-2962	17
8405-01-077-2963	17 ½

The shirts are fabricated from polyester/cotton broadcloth conforming to MIL-C-43992. The shirt is a short sleeve dress style with a convertible collar, seven button front, two breast pockets with button through flaps, pen pocket inside the left breast pocket, and shoulder loops.

14-4. IDENTIFICATION AND DESCRIPTION-Continued

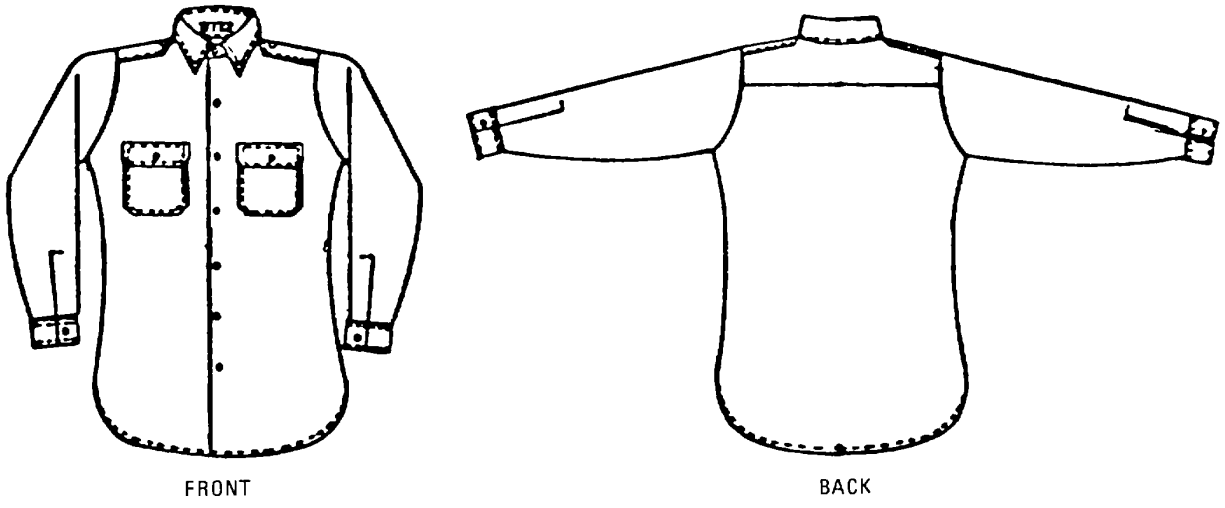

Figure 14-1. Shirt, Man's, Long Sleeve, Green 415

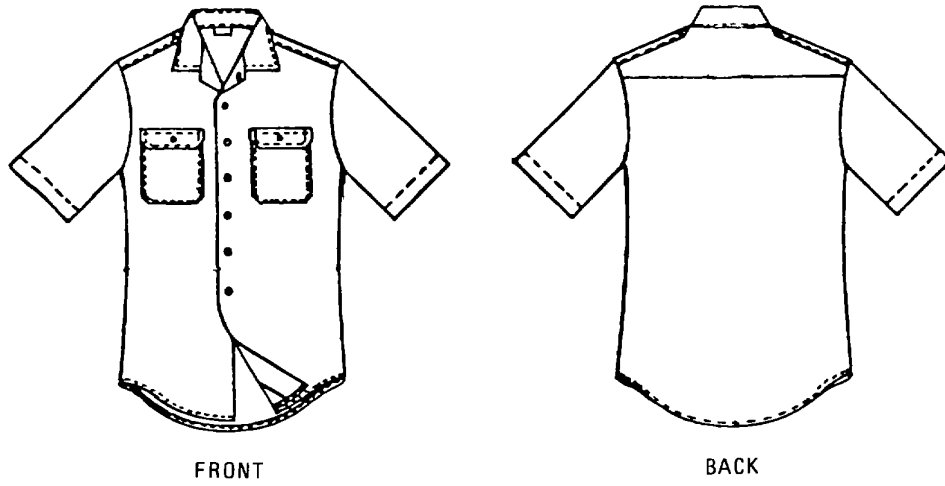

Figure 14-2. Shirt, Man's, Short Sleeve, Green 415

Section II. REPAIR PROCEDURES

14-5. MATERIALS

Materials used in the repair of the shirts shall be serviceable materials recovered from similar salvaged items, when authorized, or will be new materials as specified in Section III. New materials will be requisitioned from stock under the stock numbers and/or item description and shall conform to the appropriate specifications. When not available from stock, the materials may be purchased locally which conform as closely as possible to the standard material.

14-6. REPAIR AND MAINTENANCE

Prior to repair operations, each item shall be inspected by qualified personnel to determine the amount of repair necessary. Repair will be made as fully as skills, facilities, funds and local conditions permit. The sequence of operations shall be determined by the repairing organization, unless otherwise prescribed.

- a. Inspection. Inspect all items to determine the amount of repairs needed and whether such repairs can be accomplished within the organization, or evacuate to direct support level of maintenance
- b. Cleaning. User will keep garments clean, either by individual laundering in water by hand or machine washing with a mild soap or detergent or by use of installation laundry facilities.
- c. Organizational Repairs. Repair to be accomplished at organizational level will be hand sewing of rips, tears, loose seams, and damaged button holes. Replace missing or damaged buttons. Replacement buttons will match the original buttons in color, design, and size of the type specified in Section III.
- d. Direct Support Maintenance.
 - (1) Preliminary examination and cleaning. Dirt, mud, dust, spots, stains, and other foreign matter will be removed with a brush or by laundering. Rotten items will be discarded. Seams will be tested by grasping the item with both hands and pulling at right angles to the seams. Areas to be repaired shall be marked with crayon. Non-specification and personal marks shall be erased or obliterated.
 - (2) Laundry. Shirts shall be processed in laundry facilities in accordance with established practices set forth in FM 10-280. When such facilities are not available, items shall be laundered by contract with private industry in accordance with accepted commercial laundry practices.
 - (3) Repair.
 - (a) Stitching and restitching. Use machine sewing wherever possible for all stitching and restitching of items. Backstitch or bartack all stitching at ends to prevent raveling. Maintain proper thread tension to prevent loose stitching and to embed the lock in the center of the material sewn. Overlock all thread breaks in overedge stitching not less than $\frac{3}{4}$ inch (1.91 cm) at each break.

14-6. REPAIR AND MAINTENANCE- Continued

Restitch seams containing loose and/or broken threads. Overstitch thread breaks in type 301 stitching not less than ½ Inch (1.27 cm) at each break. When type 401 stitch is used, place looper thread on the underside. For Illustration of the various types of stitches used, see FED, STD. NO. 751 not less than ¾ inch (1.91 cm) at each break. Thread shall conform to MIL-T-43548 and the type, thread size and stitches per Inch required for the repair shall be as follows:

Use	Stitch type	Thread needle/bobbin		Stitches per inch
GENERAL	301	50/3	50/3	10-14
GENERAL	401	50/3	50/3	10-14
OVEREDGE	502 or 503	50/3	50/3	6-10
BARTACKS	---	50/3	50/3	28 PER BARTACK
BUTTONHOLES	304	50/3	50/3	42 - 52 PER BUTTONHOLE
BUTTONS	101 or 301	50/3	50/3	14 - 16 PER BUTTON 14 - 16 PER BUTTON

- (b) Patching and darning. Repair rips, tears and holes that will not be visible when garment is worn. Repair rips, tears and holes in areas ½ inch (1.27 cm) or less in greatest dimension. Repair rips, tears and holes greater than ½ Inch (1.27 cm) but not exceeding 1 Inch (2.54 cm). Cut the patch of sufficient size to extend at least ¼ to 3/8 inches (0.635 to 0.952 cm) beyond the hole or area to be patched, allowing for a ¼ inch (0.635 cm) turn under. Place the patch on the outside and sew it 1/16 to 1/8 inches (0.159 to 0.318 cm) from the edge of the patch. Cut away the damaged area to a square or rectangular shape, depending upon the shape of the hole, turn the raw edges under ¼-inch (0.635 cm) and sew 1/16 to 1/8-inches (0.159 to 0.318 cm) from the edge.
- (c) Buttons. Replace missing, broken, or damaged buttons using Item listed in Section III.
- (d) Buttonholes. Reshape enlarged buttonholes by securely tacking the ends for proper fit over corresponding buttons. Rework damaged buttonholes by stitching a small reinforcement patch to the underside of the shirt and reworking through the patch not less than ¾ inch (1.91 cm) at each break. Buttonholes shall be of the straight-cut, purl or whip type and the finished cut length according to original construction.
- (e) Pockets and flaps. Repair or replace torn, missing or defective pockets and flaps. Restitch ripped seams, loose or missing stitching on flaps and pockets. Darn small holes, cuts and tears and patch slightly larger holes. The darning and patching shall not be visible when the pocket flap is buttoned.

14-6. REPAIR AND MAINTENANCE-Continued

- (f) Shoulder loops. Restitch loose or missing stitching, and replace missing or defective shoulder loops. When the outer face of a shoulder loop shows unacceptable defects, reverse and place on opposite shoulder, provided shade of fabric matches. When replacement is necessary, fabricate shoulder loops as original construction from conforming cloth.
- (g) Hems. Turn under all frayed hems and stitch 1/16 to 1/8-inch (0.159 to 0.318 cm) from edge.

14-7. WORKMANSHIP

All work shall be accomplished by personnel skilled in the particular trade applicable to their duties in the repair of subject items. Darning shall be neatly accomplished and patches shall be of the proper size and firmly stitched to the garments. Stitching and reseaming shall be secure, and loose ends shall be trimmed and removed. Buttons shall be securely and properly attached to function as Intended. The finished items shall be completely and well repaired, thoroughly cleaned, and free from all defects which may effect serviceability or general appearance.

14-8. INSPECTION

The inspection or quality control unit is responsible for determining compliance with repair instructions and requirement for classification. In process inspections will be performed for quality of workmanship and correct application of repair procedure. The completed item will be inspected for serviceable appearance and condition, to insure against return of a substandard product to supply channels.

Section III. MATERIALS

SMR CODE	NATIONAL STOCK NUMBER	DESCRIPTION	UNIT OF ISSUE
		SHIRT, MEN'S, SHORT SLEEVE, ARMY TAN 445	
XBFZZ		Cloth, Polyester/Cotton, Twill, Army Tan 445, conforming to Type I of MIL-C-43791	YD
PAFZZ		Thread, polyester, cotton-covered, conforming to size 70/2 ply, color Tan G. C. A. 66036 of MIL-T-43548; Purchased locally.	CE
PAFZZ	8315-00-164-4103	Buttons, Type II, class K, style 25, 19 line, shade DOD Tan AJ, Cable 62028 of V-B-871	GR
		SHIRT, MAN'S, POLYESTER/COTTON, ARMY TAN 446	
XBFZZ	8305-01-028-3482	Cloth, polyester/cotton broadcloth. Tan 446, conforming to Type I, class 3 of MIL-C-43479	YD
PAFZZ		Thread, polyester, cotton-covered, conforming to size 70/2 ply, color Tan X, C. A 66041 of MIL-T-43548	CE
PAFZZ	8315-00-164-4103	Buttons, Type II, class K, style 25, 19 line, shade DOD Tan AJ, Cable No. 62028 of V-B-871	GR
		SHIRT, MAN'S, POLYESTER/COTTON GREEN 415	
XBFZZ	6305-01-074-1843	Cloth, Broadcloth, Polyester/Cotton Green 415, conforming to MIL-C-43992	YD
PAFZZ		Thread, Polyester, Cotton-covered, conforming to size 70/3 ply, color White AH, C. A. 66050 of MIL-T-43548	CE

CHAPTER 15

MAINTENANCE OF TEMPERATE, DAYTIME DESERT AND
HOTWEATHER BATTLE DRESS UNIFORMS (BDU)

Section I. INTRODUCTION

15-1. SCOPE

This chapter provides instructions that cover the materials, methods and procedures for repair and maintenance of the Temperate, Daytime Desert, and Hot Weather Battle Dress Combat Coat and Trousers.

15-2. COMMODITY SPECIFICATION

a. Items.

SPECIFICATION	ITEM
MIL-C-44048	Coat, Camouflage Pattern Type I Temperate Type II Desert Type III Hot Weather
MIL-T-44047	Trousers, Camouflage Pattern Type I Temperate Type II Desert Type III Hot Weather

b. Components.

SPECIFICATION	ITEM
V-B-871	Button, Sewing Hole, and Button Staple (Plastic)
V-T-276	Thread, Cotton
V-T-280	Thread, Gimp, Cotton, Buttonhole
MIL-B-543	Buckles, Tongueless and Web Strap
MIL-T-5038	Tape, Textile and Webbing, Textile Reinforcing, Nylon
MIL-T-43548	Thread, Polyester, Cotton-Covered
MIL-T-43566	Tape, Textile, Cotton, General Purpose, Natural
MIL-C-44031	Cloth, Camouflage Pattern Woodland, Cotton & Nylon
MIL-C-44034	Cloth, Twill, Camouflage Pattern, Cotton and and Nylon for Desert Uniform

15-3. IDENTIFICATION AND DESCRIPTION

a. Coat, Camouflage Pattern.

- (1) Coat, Camouflage Pattern, Temperate, is fabricated of cotton and nylon twill cloth. It is a single breasted coat style design with collar, four patch bellows-type pockets with flaps, straight cut bottom, and sleeves with elbow patches and an adjustable closure. The pockets have sewn eyelets located in the bottom of the Inner bellows piece to prevent water accumulation in the pocket. There is a pencil pocket in the left chest pocket and a pencil opening in the pocket flap to allow for storage of pencil without unbuttoning the flap. The coat back is cut from one piece of material. The front is secured by buttons and buttonholes concealed by a fly on the left front. The pockets are also closed by buttons and buttonholes concealed within the pocket flaps. All major joining seams are of double-lapped and double-stitched construction. (See figure 15-1 and table 15-1.)
- (2) Coat, Camouflage Pattern, Daytime Desert, is fabricated of cotton and nylon twill cloth. It is the same design and construction as the temperate coat, except that it has an internal back yoke. (See figure 15-1 and table 15-2.)
- (3) Coat, Camouflage Pattern, Hot Weather, is fabricated from cotton, Type III ripstop poplin cloth. It is the same design and construction as the temperate coat (See figure 15-1 and table 15-3.)

b. Trousers, Camouflage Pattern.

- (1) Both Type I - Temperate Camouflage and Type II - Desert Day Camouflage Trousers are fabricated from cotton and nylon twill cloth. The trousers have a grown-on waistband with two buckle waist adjustment tabs, two side and hip inside hanging pockets two bellows-type pockets, a button front fly, seat patch, knee patches and leg hem drawcords. The cargo pockets have one sewn eyelet located at the bottom back end of the pocket. The hip and cargo pocket flaps are closed with buttons and buttonholes concealed within the flaps. (See figure 15-2 and tables 15-4 and 15-5.)
 - (2) The Hot Weather Camouflage Trousers are fabricated from cotton, Type III ripstop poplin cloth. The trousers are of the same design and construction as the temperate trousers (See figure 15-2 and table 15-6.)
-

15-3. IDENTIFICATION AND DESCRIPTION-Continued

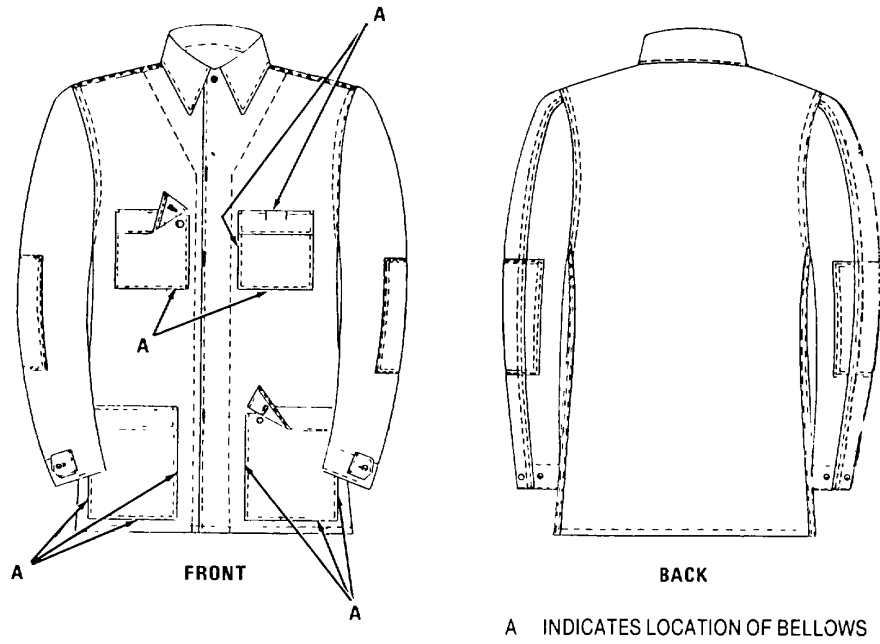

Figure 15-1. Combat Camouflage Pattern Coat

15-3. IDENTIFICATION AND DESCRIPTION-Continued

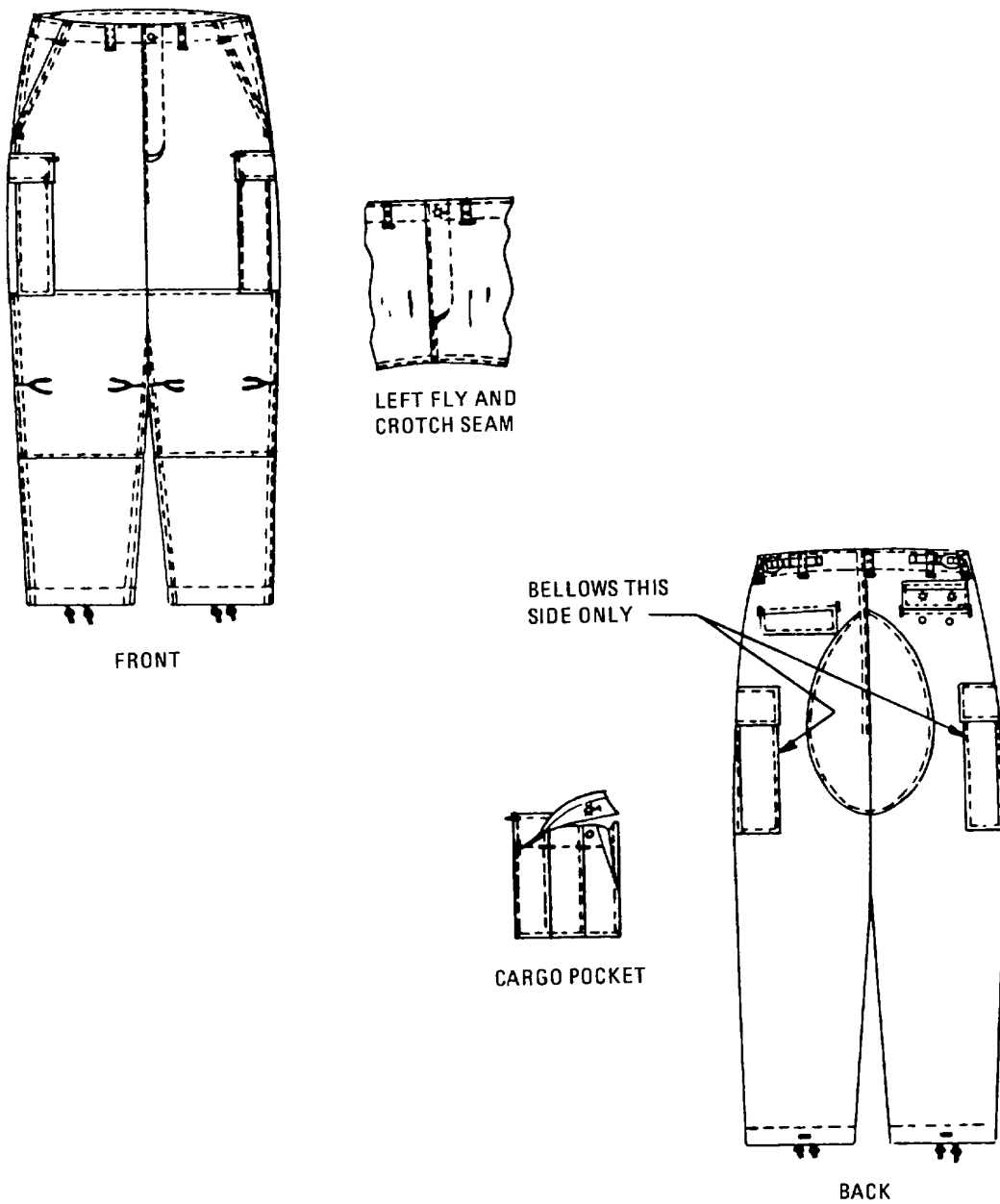

Figure 15-2. Combat Camouflage Pattern Trousers

15-3. IDENTIFICATION AND DESCRIPTION-Continued

COAT SIZE CHART
MIL-C-44048B

SIZE	NATO SIZE	CHEST, INCHES (CM)	HEIGHT, INCHES (CM)
X-Small-X-Short	5060/7484	Up to 33(84)	From 59(149) to 63(159)
X-Small-Short	6070/7484	Up to 33(84)	From 63(159) to 67(169)
X-Small-Regular	7080/7484	Up to 33(84)	From 67(169) to 71(180)
Small-XX-Short	4050/8494	From 33(84) to 37(94)	Up to 59(149)
Small-X-Short	5060/8494	From 33(84) to 37(94)	From 59(149) to 63(159)
Small-Short	6070/8494	From 33(84) to 37(94)	From 63(159) to 67(169)
Small-Regular	7080/8494	From 33(84) to 37(94)	From 67(169) to 71(180)
Small-Long	8090/8494	From 33(84) to 37(94)	From 71(180) to 75(190)
Small-X-Long	9000/8494	From 33(84) to 37(94)	From 75(190) to 79(200)
Medium-XX-Short	4050/9404	From 37(94) to 41(104)	Up to 59(149)
Medium-X-Short	5060/9404	From 37(94) to 41(104)	From 59(149) to 63(159)
Medium-Short	6070/9404	From 37(94) to 41(104)	From 63(159) to 67(169)
Medium-Regular	7080/9404	From 37(94) to 41(104)	From 67(169) to 71(180)
Medium-Long	8090/9404	From 37(94) to 41(104)	From 71(180) to 75(190)
Medium-X-Long	9000/9404	From 37(94) to 41(104)	From 75(190) to 79(200)
Large-X-Short	5060/0414	From 41(104) to 45(115)	From 59(149) to 63(159)
Large-Short	6070/0414	From 41(104) to 45(115)	From 63(159) to 67(169)
Large-Regular	7080/0414	From 41(104) to 45(115)	From 67(169) to 71(180)
Large-Long	8090/0414	From 41(104) to 45(115)	From 71(180) to 75(190)
Large-X-Long	9000/0414	From 41(104) to 45(115)	From 75(190) to 79(200)
X-Large-Regular	7080/1424	Above 45(115)	From 67(169) to 71(180)
X-Large-Long	8090/1424	Above 45(115)	From 71(180) to 75(190)

15-3. IDENTIFICATION AND DESCRIPTION-Continued

TROUSER SIZE CHART
MIL-T-44047A

SIZE	NATO SIZE	WAIST, INCHES (CM)	HEIGHT, INCHES (CM)
X-Small-X-Short	6067/5869	Up to 27(68)	Up to 26-½(67)
X-Small-Short	6775-5869	Up to 27(68)	From 26-½(67) to 29-½(75)
X-Small-Regular	7583/5869	Up to 27(68)	From 29-½(75) to 32-½(82)
X-Small-Long	8390/5869	Up to 27(68)	From 32-½(82) to 35-½(90)
Small-X-Short	6067/6979	From 27(68) to 31(78)	Up to 26-½(67)
Small-Short	6775/6979	From 27(68) to 31(78)	From 26-½(67) to 29-½(75)
Small-Regular	7583/6979	From 27(68) to 31(78)	From 29-½(75) to 32-½(82)
Small-Long	8390/6979	From 27(68) to 31(78)	From 32-½(82) to 35-½(90)
Small-X-Long	9098/6979	From 27(68) to 31(78)	Over 35-½(90)
Medium-X-Short	6067/7989	From 31(78) to 35(89)	Up to 26-½(67)
Medium-Short	6775-7989	From 31(78) to 35(89)	From 26-½(67) to 29-½(75)
Medium-Regular	7583/7989	From 31(78) to 35(89)	From 29-½(75) to 32-½(82)
Medium-Long	8390/7989	From 31(78) to 35(89)	From 32-½(82) to 35-½(90)
Medium-X-Long	9098/7989	From 31(78) to 35(89)	Over 35-½(90)
Large-Short	6775-8999	From 35(89) to 39(99)	From 26-½(67) to 29-½(75)
Large-Regular	7583/8999	From 35(89) to 39(99)	From 29-½(75) to 32-½(82)
Large-Long	8390/8999	From 35(89) to 39(99)	From 32-½(82) to 35-½(90)
Large-X-Long	9098/8999	From 35(89) to 39(99)	Over 35-½(90)
X-Large-Short	6775/9909	Over 39(99)	From 26-½(67) to 29-½(75)
X-Large-Regular	7583/9909	Over 39(99)	From 29-½(75) to 32-½(82)
X-Large-Long	8390/9909	Over 39(99)	From 32-½(82) to 35-½(90)

15-3. IDENTIFICATION AND DESCRIPTION-Continued

Table 15-1. National Stock Numbers for Temperate, Woodland Camouflage Coat

SIZE	NSN
X Small	
X-Short	8415-01-084-1639
Short	8415-01-084-1640
Regular	8415-01-134-3170
Small	
XX-Short	8415-01-084-1653
X-Short	8415-01-084-1641
Short	8415-01-084-1642
Regular	8415-01-084-1643
Long	8415-01-084-1644
X-Long	8415-01-134-3171
Medium	
XX-Short	8415-01-084-1654
X-Short	8415-01-084-1645
Short	8415-01-084-1646
Regular	8415-01-084-1647
Long	8415-01-084-1648
X-Long	8415-01-134-3172
Large	
X-Short	8415-01-084-1655
Short	8415-01-084-1649
Regular	8415-01-084-1656
Long	8415-01-084-1650
X-Long	8415-01-134-3173
X Large	
Regular	8415-01-084-1651
Long	8415-01-084-1652

15-3. IDENTIFICATION AND DESCRIPTION-Continued

Table 15-2. National Stock Numbers for Daytime Desert Coat

SIZE	NSN
X Small	
X-Short	8415-01-102-6757
Short	8415-01-102-6758
Regular	8415-01-139-2521
Small	
XX-Short	8415-01-102-6759
X-Short	8415-01-102-6760
Short	8415-01-102-6761
Regular	8415-01-102-6762
Long	8415-01-102-6763
X-Long	8415-01-139-2522
Medium	
XX-Short	8415-01-102-6764
X-Short	8415-01-102-6765
Short	8415-01-102-9128
Regular	8415-01-102-6766
Long	8415-01-102-6767
X-Long	8415-01-139-2523
Large	
X-Short	8415-01-102-6768
Short	8415-01-102-6769
Regular	8415-01-102-6770
Long	8415-01-102-6771
X-Long	8415-01-139-2524
X-Large	
Short	
Regular	8415-01-102-6772
Long	8415-01-102-6773

15-3. IDENTIFICATION AND DESCRIPTION-Continued

Table 15-3. National Stock Numbers for Hot Weather, Woodland Camouflage Coat

SIZE	NSN
X-Small	
X-Short	8415-01-184-1318
Short	8415-01-184-1319
Regular	8415-01-184-1320
Small	
XX-Short	8415-01-184-1321
X-Short	3415-01-184-1322
Short	8415-01-184-1323
Regular	8415-01-184-1324
Long	8415-01-184-1325
X-Long	8415-01-184-1326
Medium	
XX-Short	8415-01-184-1327
X-Short	8415-01-184-1328
Short	8415-01-184-1329
Regular	8415-01-184-1330
Long	8415-01-184-1331
X-Long	8415-01-184-1332
Large	
X-Short	8415-01-184-1333
Short	8415-01-184-1334
Regular	8415-01-184-1335
Long	8415-01-184-1336
X-Long	8415-01-184-1337
X-Large	
Regular	8415-01-184-1338
Long	8415-01-184-1339

15-3. IDENTIFICATION AND DESCRIPTION-Continued

Table 15-4. National Stock Numbers for Temperate Woodland Camouflage Coat

SIZE	NSN
X-Small	
S-Short	8415-01-084-1705
Short	8415-01-084-1716
Regular	8415-01-084-1706
Long	8415-01-134-3193
Small	
X-Short	8415-01-084-1707
Short	8415-01-084-1708
Regular	8415-01-084-1709
Long	8415-01-084-1710
X-Long	8415-01-134-3194
Medium	
X-Short	8415-01-084-1711
Short	8415-01-084-1712
Regular	8415-01-084-1713
Long	8415-01-084-1717
X-Long	8415-01-134-3195
Large	
Short	8415-01-084-1016
Regular	8415-01-084-1017
Long	8415-01-084-1714
X-Long	8415-01-134-3196
X Large	
Short	8415-01-084-1718
Regular	8415-01-084-1715
Long	8415-01-134-3197

15-3. IDENTIFICATION AND DESCRIPTION-Continued

Table 15-5. National Stock Numbers for Daytime Desert Trousers

SIZE	NSN
X-Small	
X-Short	8415-01-102-6795
Short	8415-01-102-6796
Regular	8415-01-102-6797
Long	8415-01-140-5461
Small	
X-Short	8415-01-102-6798
Short	8415-01-102-6799
Regular	8415-01-102-6800
Long	8415-01-102-6801
X-Long	8415-01-140-5462
Medium	
X-Short	8415-01-102-6802
Short	8415-01-102-6803
Regular	8415-01-102-6804
Long	8415-01-102-6805
X-Long	8415-01-140-5463
Large	
Short	8415-01-102-9134
Regular	8415-01-102-6806
Long	8415-01-102-6807
X-Long	8415-01-140-5464
X-Large	
Short	8415-01-102-6808
Regular	8415-01-102-6809
Long	8415-01-140-5465

15-3. IDENTIFICATION AND DESCRIPTION-Continued

Table 15-6. National Stock Numbers for Hot Weather, Woodland Camouflage Trousers

SIZE	NSN
X Small	
X-Short	8415-01-184-1340
Short	8415-01-184-1341
Regular	8415-01-184-1342
Long	8415-01-184-1343
Small	
X-Short	8415-01-184-1344
Short	8415-01-184-1345
Regular	8415-01-184-1346
Long	8415-01-184-1347
X-Long	8415-01-184-1348
Medium	
X-Short	8415-01-184-1349
Short	8413-01-184-1350
Regular	8415-01-184-1351
Long	8415-01-184-1352
X-Long	8415-01-184-1353
Large	
Short	8415-01-184-1354
Regular	8415-01-184-1355
Long	8415-01-184-1356
X-Long	8415-01-184-1357
X-Large	
Short	8415-01-184-1358
Regular	8415-01-184-1359
Long	8415-01-184-1360

Section II. REPAIR PROCEDURES

15-4. MATERIALS

General materials used in the repair of the coat and trousers shall be serviceable materials recovered from similar salvaged items when authorized, or will be new materials as specified in Section III. New materials will be requisitioned from stock numbers and item description and shall conform to the appropriate specifications. When not available from stock, the materials may be purchased locally that conform as closely as possible to the standard material.

15-5. REPAIR AND MAINTENANCE

Prior to repair operations, each item shall be inspected by qualified personnel to determine the amount of repair necessary. The following methods shall be observed as fully as skills, facilities, funds and local conditions permit. The sequence of operations shall be determined by the repairing organizations, unless otherwise prescribed.

- a. Inspection.. Inspect all items to determine the amount of repairs needed and whether such repairs can be accomplished within the organization or evacuate to Direct Support level of Maintenance.
- b. Repair. The following repairs will be accomplished by hand or organizational maintenance.
 - (1) Replace missing and damaged buttons and loose belt loops.
 - (2) Iron-on patches. Rips and tears other than stress points (e g crotch seams, pocket seams, pocket flap seams, etc.) may be repaired by iron-on patches. Any rip or tear closer than $\frac{3}{4}$ inch (1.91 cm) to any seam will be repaired by sewing.
 - (a) Patch size. The iron-on patch shall be cut to the size and shape that it will extend $\frac{3}{4}$ inch (1.91 cm) in all directions beyond the tear or other damage. Patches will have rounded corners.
 - (b) Patching procedures for iron-on patches. When patching by hand, iron place patch to the inside of the garment. The garment may be turned inside out or the patch may be inserted within the garment, taking care that the patch is centered in the desired position. Trim heavily raveled ends with scissors. Smooth out the area to be patched so that the tear is closed or very nearly closed and so that there will be no wrinkles, folds, seams, or other protrusions under the iron when it is applied (See figure 15-3.).

15-5. REPAIR AND MAINTENANCE-Continued

Figure 15-3. Preparing a tear for patching.

1. Prewarm the area to be patched by pressing with a household electric dry iron or steam iron used dry. With iron set at the cotton indicator or as high as possible without scorching the fabric, apply the iron for 5 seconds or more immediately position the patch. Hold the iron on the patch for about 12 seconds. Use no more than a slight rotating motion of the iron and apply constant pressure. Remove the iron and allow patch area to cool in place about 5 seconds, or long enough so that the patch will not drift off when the garment is removed from the ironing board.
2. Patches that are longer than the iron may be ironed in sections, starting at the center and completing each section before moving to the next section. Overlapping of the iron upon previously bonded section is permissible. Carefully trim away any frayed protrusions at the torn edges.

15-5. REPAIR AND MAINTENANCE-Continued

- (c) Quality control. Adjust heating, pressing and cooling times as required for the Iron being used. Check the quality of the adhesive bond periodically and adjust heating times and temperatures.

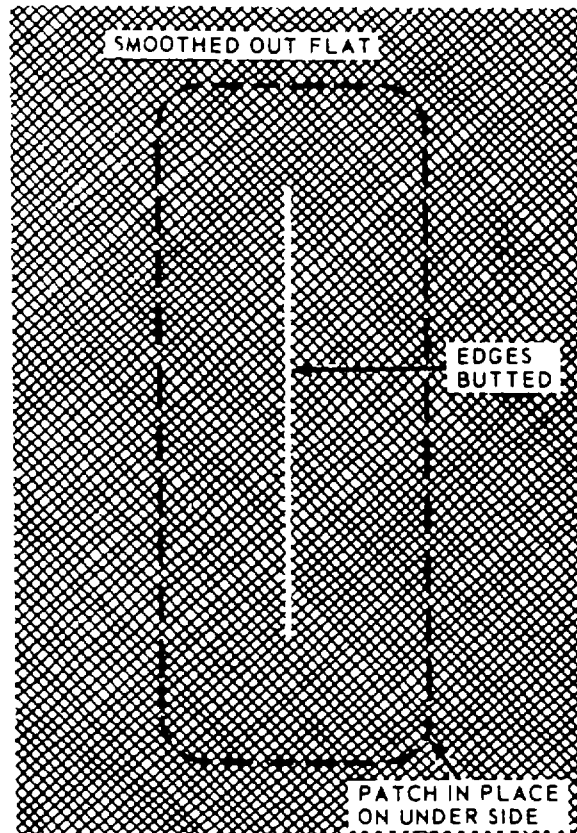
NOTE

Check test. Periodically during the work and when adjusting the iron test a patch which has cooled for about 5 minutes by picking with the fingers at the edge of the patch until a tab about 1/4 to 1/2 inch (0.635 to 1.27 cm) long is formed. Pull hard on the tab with fingers. A well bonded tab will be difficult to peel off and will indicate that iron adjustment and heating time are adequate. Replace the check test patch with a new patch.

1. If the adhesive strikes through the patch cloth, too much heat has been applied. Reduce time of pressing or temperature of the iron. A small amount of strike through is not objectionable provided the patch meets the check test.
 2. A bonded patch which has a lifted edge will be re-ironed. A bonded patch which has been subjected to the check test will be replaced.
 3. When patching by special automatic press, the platen temperature, dwell time, dwell pressure, and other details shall be in accordance with the press manufacturer's instructions.
- c. Cleaning. Items shall be cleaned by individual laundering or by utilizing laundry facilities provided at the installation.
- d. Direct Support Level of Maintenance.
- (1) Preliminary examination and cleaning. Dirt, mud, dust spots, mildew stain, and other foreign matter shall be removed with a brush or by laundering. Mildewy and rotten items shall be discarded. Seams shall be tested by grasping the item with both hands and pulling at right angles to the seam. Areas to be repaired shall be marked with crayon. Non-specification and personnel marks shall be erased or obscured.
 - (2) Laundry. Items shall be processed in laundry facilities in accordance with established practices set forth in FM 10-280. When such facilities are not available, items shall be laundered by contract with private industry in accordance with accepted commercial laundry practices.
 - (3) Patching Garments may be patched by either the iron on or stitched patches.

15-5. REPAIR AND MAINTENANCE-Continued

(4) Sewing Machine Repairs, Stitching and Restitching. All sewing, except emergency repair, shall be machine sewn. When ends of machine stitching type 301 are not caught in other seams or stitching, they shall be back-stitched not less than 1 inch (2.54 cm) at each break. Ends of a continuous line of stitching shall overlap not less than 1/2 inch (1.27 cm). Thread breaks (all stitch types) shall be repaired by stitching back of the break not less than 1/2 inch (1.27 cm). Thread tension shall be properly maintained to avoid loose stitching and locks shall be imbedded in the center of the material sewn. Stitch spacing used for restitching and type of seams, shall be the same as in the original construction Seams with loose and/or weak thread shall be restitched. For illustrations of the various types of stitches used, see FED STD-751. The following types of stitch, thread size and stitches per inch for the repair (table 15-7).

Table 15-7. Stitching Instruction

LOCATION	STITCH TYPE	THREAD		STITCHES PER INCH
		NEEDLE	BOBBIN	
General	301	50/3	50/3	10-14
General	401	50/3	50/3	10-14
Bartacks	Bartack	50/3	50/3	28 per Bartack
Buttonholes	Buttonhole	50/3	50/3	52-56 per Buttonhole
Buttons	101 or 301	50/3	50/3	20-24 per Button
Eyelets	Eyelet Machining	50/3	50/3	19-24 per Eyelet

(5) Patching and darning. Patching and darning may be applied to any area of the items Repair small tears not more than 1/2 inch (1.27 cm) across with a darning or zigzag stitch. Patch holes with a diameter of 1/4 inch (0.635 cm) or more. Repair rips, tears, and thin areas greater than 1/2 inch (1.27 cm) by patching. Patches shall be limited to a maximum of 2 inches (5.08 cm) in the greatest dimension. Patches shall match the garment in color and type of material. Insert patch under damaged area; cut away damaged area and turn edges under approximately 3/8 inch (0.952 cm). Cut patch large enough to extend not less than 1/2 inch (1.27 cm) and not more than 1 inch (2.54 cm) around the perimeter of the opening with 3/8 inch (0.952 cm) turn-under of all edges except selvage edges Precut all patches to provide for symmetry. Materials shall be those specified in Section III.

(a) Buttons. Replace missing, loose, or damaged buttons with buttons conforming to those listed in Section III . Attach the buttons securely and align with eyelet of respective buttonholes.

15-5. REPAIR AND MAINTENANCE-Continued

- (b) Buttonholes. Buttonholes shall be of the eyelet-end taper-bar type worked over gimp. Repair damaged buttonholes by reshaping enlarged buttonholes before reworking. Pull into shape and hand or machine whip a small reinforcement patch to the underside of the buttonhole. Then rework buttonhole through the patch.
 - (c) Belt loops and drawcord. Replace missing, broken or torn belt loops and drawcords with new parts of matching size and material. Such parts shall be fastened in a like manner to those being replaced and shall be properly positioned. Material for drawcord shall conform to that listed in Section III.
 - (d) Pockets. Darn or machine patch small rips at corners or broken seams. Inside hanging pockets shall be repaired by piecing, when required.
 - (e) Hems. Turn under all frayed hems and stitch in place.
 - (f) Waistband adjusting straps. Replace missing or damaged waistband straps with new parts of like size and design.
 - (g) Buckles. Replace missing, broken, or damaged buckles with like buckles in size and type specified in Section III.
- (6) Resizing. Resize all garments after complete repair and cleaning according to item group schedule of sizes listed below. When items deviate in size from original marking, obliterate the old marking and print or stamp the proper size with an indelible pencil or waterproof ink near old size. When the measurements do not correspond to a size listed, remark items to correspond to the next lowest size. Items with measurements falling below the lowest measurement in the schedule will not be accepted for remarking. Refer to appropriate table for measuring and sizing instructions for each garment.
- (a) Camouflage Combat Coats (See table 15-8).

NOTE

Chest. Measurements shall be taken with coat buttoned at point in line with pit of armhole, from folded edge to folded edge. This measurement is one-half actual size.

Length. Measurement shall be taken along center of back from under collar seam to bottom edge of coat.

Sleeve Length. Measure from base of armhole along underarm seam to bottom edge of sleeve.

15-5. REPAIR AND MAINTENANCE-Continued

(b) Camouflage Combat Trousers (See table 15-9).

NOTE

Waist. With the waistband and fly closed and the trousers placed flat upon a table, measure along center of waistband from side fold to side fold.

Leg Length. Measure inseam of trousers from crotch to bottom of trouser leg.

Table 15-8. Camouflage Combat Coats

	XX SHORT	X SHORT	SHORT	REGULAR	LONG	X LONG
Half Chest						
X-Small		19-1/2	19-1/2	19-1/2		
Small	21-1/2	21-1/2	21-1/2	21-1/2	21-1/2	21-1/2
Medium	32-1/2	23-1/2	23-1/2	23-1/2	23-1/2	23-1/2
Large		25-1/2	25-1/2	25-1/2	25-1/2	25-1/2
X-Large			27-1/2	27-1/2		
Back Length						
X-Small		27-1/8	28-1/8	29-5/8		
Small	26-5/8	27-5/8	28-5/8	30-1/8	31-1/2	32-7/8
Medium	27-1/8	28-1/8	29-1/8	30-5/8	32	33-3/8
Large		28-5/8	29-5/8	31-1/8	32-1/2	33-7/8
X-Large				31-5/8	33	
Sleeve Length						
X--Small		16-1/2	17	18		
Small	16	16-1/2	17	18	19	
Medium	16	16-1/2	17	18	19	20
Large		16-1/2	17	18	19	20
X-Large				18	19	20

Tolerance ± 3/4 inch for all measurements.

15-5. REPAIR AND MAINTENANCE - Continued*Table 15-9. Camouflage Combat Trousers*

SIZE	INSEAM					
	HALF WAIST	X SHORT	SHORT	REGULAR	LONG	X LONG
X-Small	13-3/4	28	30	32	34	
Small	15-3/4	28	30	32	34	36
Medium	17-3/4	28	30	32	34	36
Large	19-3/4		30	32	34	36
X-Large	21-3/4		30	32	34	
Tolerance	±1/2	± 3/4	± 3/4	± 3/4	± 3/4	± 3/4

15-6. WORKMANSHIP

All work shall be accomplished by personnel skilled in the particular trade applicable to their duties. Darning shall be neatly accomplished and patches shall be of the proper size and firmly stitched to the garments. Stitching and reseaming shall be secure and loose ends shall be turned and removed. Buttons, buckles and belt loops shall be securely and properly attached and function as intended. The finished items shall be complete and well repaired, thoroughly cleaned, and free from all defects which may affect serviceability or general appearances.

15-7. INSPECTION

The inspection or quality control unit is responsible for determining compliance with repair instructions and requirements for classification. In-process inspections will be performed for quality of workmanship and correct application of repair procedures. The completed item will be inspected for serviceable condition and appearance to insure against return of a sub-standard product to supply channels.

Section III. MATERIALS - Continued

(1) SMR CODE	(2) NATIONAL STOCK NUMBER	(3) DESCRIPTION	(4) UNIT OF ISSUE
PAFZZ	8305-01-084-1670	Cloth, Cotton/Nylon; Twill Woodland Camouflage Print, conforming to Class 1 of MIL-C-44031	YD
PAFZZ	8305-01-102-6775	Cloth, Cotton/Nylon; Twill Desert Day Camouflage Print, conforming to Class 2 of MIL-C-44034	YD
PAFZZ	8305-01-167-8403	Cloth, Wind Resistant Poplin Cotton (Hot Weather Battle Dress Uniforms)	YD
XBFZZ		Tape, textile, cotton; Tan 337, conforming to Type I, Class 3 of MIL-T-43566. Purchase Locally.	YD
PAFZZ	8315-00-255-7673	Tape, textile, nylon; Olive Drab No. 7, conforming to Type III of MIL-T-5038.	YD
XBFZZ		Tape, textile, nylon; Tan 337 conforming to Type III of MIL-T-5038. Purchase Locally.	YD
PAFZZ	8315-00-899-0029	Buttons sewing hole, composition, Type II, Class D, style 26, 30 line, Olive Green BP Cable No. 62016, conforming to V-B-871	GR
XBFZZ		Buttons, composition, Type II, Class D, style 26, 30 line; Tan AJ. Cable No. 62028. Purchase Locally.	EA
PAFZZ	8310-01-066-0973	Thread, Cotton-Covered, polyester. Ticket No. 50/3 ply. OD-S1, conforming to MIL-T-43548	CE
PAFZZ		Thread, Cotton-Covered, polyester, Ticket No. 50/3 ply. Khaki P-1, conforming to MIL-T-43548	CE
PAFZZ	8310-00-262-0094	Thread, Gimp, cotton OD-S1, Type I or II size 8 conforming to V-T-280	SL
XBOZZ		Buckles, Waist Adjustment Strap; Cannibalize from Salvage Trousers	EA
PAF	8305-00-460-4200	Cloth, Coated; Iron-On Patch, MIL-C-43677, Ty I	YD

CHAPTER 16

MAINTENANCE OF DESERT NIGHT PARKA AND TROUSERS

Section I. INTRODUCTION

16-1. SCOPE

This chapter provides Instructions and prescribes the materials, methods and procedures for the repair and maintenance of the desert night parka and trousers.

16-2. COMMODITY SPECIFICATIONS

a. Items:

SPECIFICATION	ITEM
MIL-P-44087 MIL-T-44094	Parka, Night Camouflage, Desert Trousers, Night Camouflage, Desert

b. Components:

SPECIFICATION	ITEM
V-B-871 V-T-280 JJ-W-155 MIL-B-371 MIL-T-5038 MIL-E-20652/1A MIL-F-21840 MIL-T-43548 MIL-C-43701 MIL-C-44034	Button, Sewing Hole, and Button, Staple (Plastic) Thread, Gimp, Cotton, Buttonhole Webbing, Textile (Cotton) Elastic Braid, Textile, (Tubular) Tape, Textile and Webbing, Textile Reinforcing, Nylon Eyelet, Metallic, Rolled Flange Type, and Eyelet Washer Fastener Tapes, Hook and Pile, Synthetic Thread, Polyester, Cotton Covered and Rayon Covered Cord, Elastic, Nylon Cloth, Twill, Camouflage Pattern, Cotton and Nylon for Desert Uniform

16-3. TECHNICAL PUBLICATIONS

NUMBER	TITLE
FM 10-280	Field Laundry, Bath and Clothing Exchange Operations

16-4. IDENTIFICATION AND DESCRIPTION

- a. Parka, Night Camouflage, Desert, MIL-P-44087, is fabricated from desert grid green nylon and cotton twill fabric. The parka is a single breasted outer garment with a hood, button/button-hole front closure, two slip type hand openings with button closure flaps and elasticized sleeve cuffs. Neck, hood, waist and hemline drawcords are provided. Inside buttons are provided for attachment of the liner. (See figure 16-1 and table 16-1.)

16-4. IDENTIFICATION AND DESCRIPTION-Continued

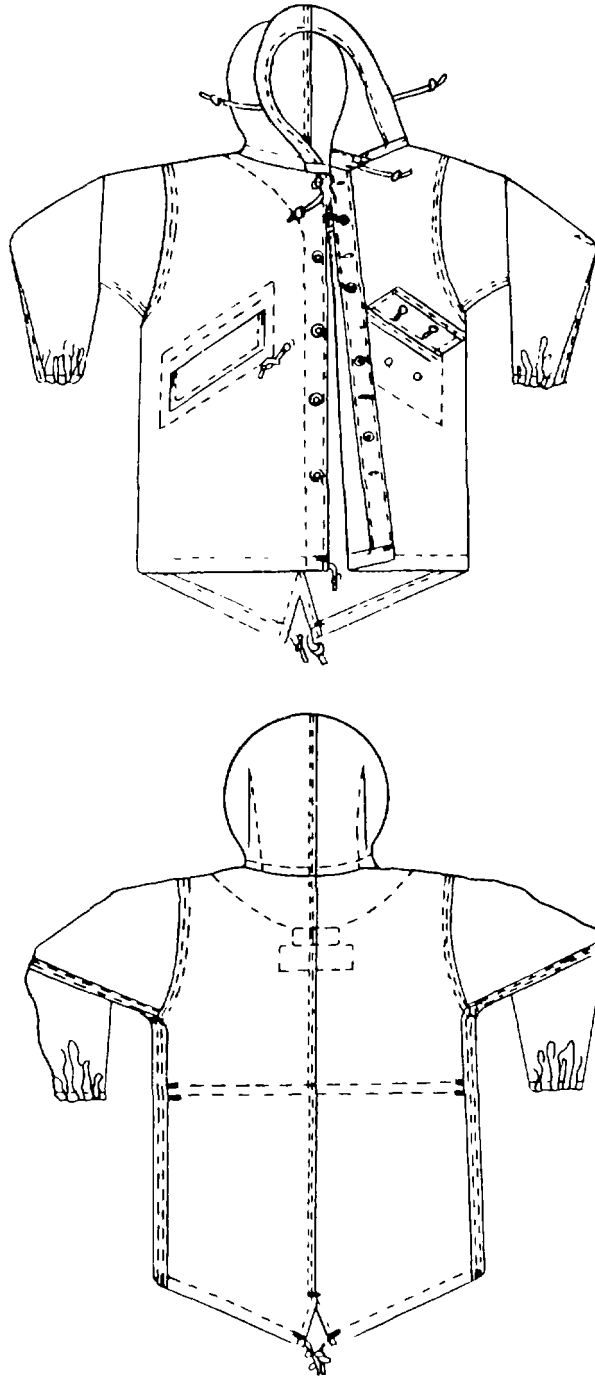

Figure 16-1. Desert Night Camouflage Parka.

16-4. IDENTIFICATION AND DESCRIPTION-Continued

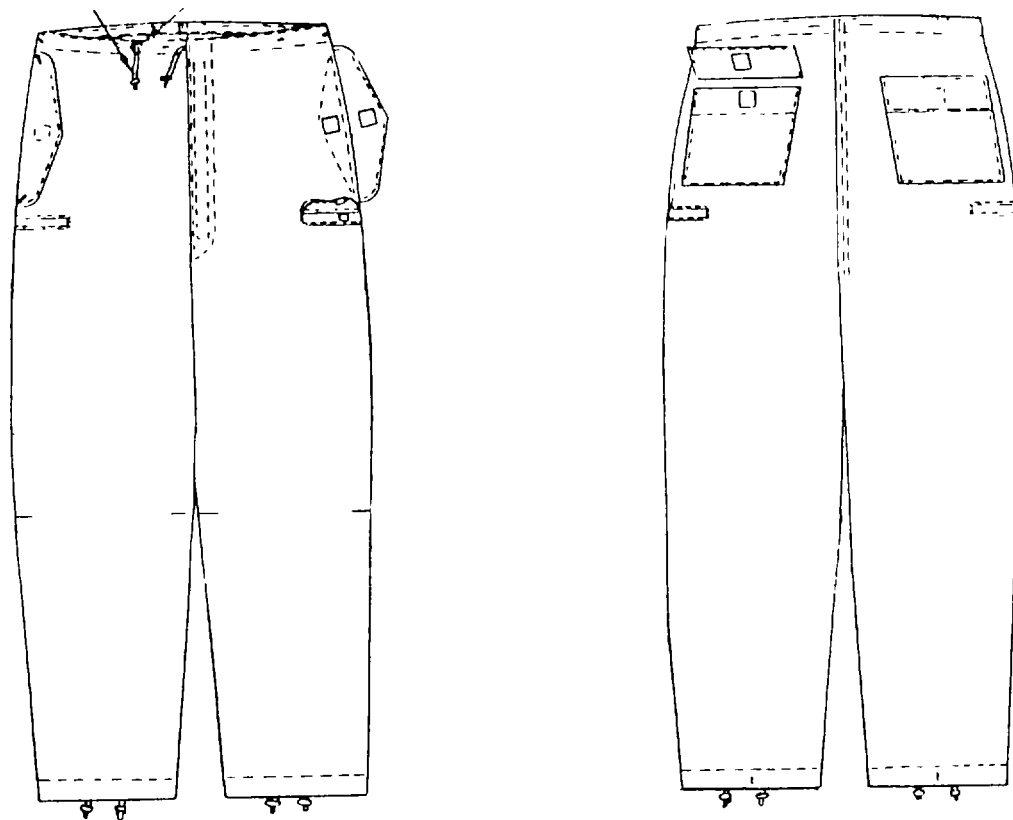

Figure 16-2. Desert Night Camouflage Trousers

16-4. IDENTIFICATION AND DESCRIPTION-Continued

- b. Trousers, Night Camouflage, Desert, MIL-T-44094, are fabricated from desert grid green nylon and cotton twill fabric. The trousers have a front fly opening, two vertical side openings with flaps, two horizontal leg openings with flaps, and two hip patch pockets with flaps-all have hook and pile fastener tape closures. Waistband and leg bottom drawcords are provided for adjustment. (See figure 16-2 and table 16-2.)

Table 16-1. National Stock Numbers for Desert Night Parka

SIZE	NSN
X-Small	8415-01-102-6278
Small	8415-01-102-6279
Medium	8415-01-102-6280
Large	8415-01-102-6281
X-Large	8415-01-102-6282

Table 16-2. National Stock Numbers for Desert Night Trousers

SIZE	NSN
X-Small	
Short	8415-01-102-6285
Regular	8415-01-102-6286
Long	8415-01-102-6287
Small	
Short	8415-01-102-6288
Regular	8415-01-102-6289
Long	8415-01-102-6290
Medium	
Short	8415-01-102-6291
Regular	8415-01-102-6292
Long	8415-01-102-6293
Large	
Short	8415-01-102-6294
Regular	8415-01-102-6295
Long	8415-01-102-6296
X-Large	
Short	8415-01-102-6297
Regular	8415-01-102-6298
Long	8415-01-102-6299

Section II. REPAIR PROCEDURES

16-5. MATERIALS I

Materials used in repair of the desert night parka and trousers shall be serviceable materials recovered from similar salvaged items, when authorized or will be new materials as specified in Section III. New materials will be requisitioned from stock under the stock number and/or item description and shall conform to the appropriate specification. When not available from stock, the materials may be purchased locally that conform as closely as possible to the standard sample.

16-6. REPAIR AND MAINTENANCE

Prior to repair operations, each item shall be inspected by qualified personnel to determine the amount of repair necessary. Repairs will be made as fully as skills, facilities, funds, and local conditions permit. The sequence of operations shall be determined by the repairing organization, unless otherwise prescribed.

- a. Inspection. Inspect all items to determine the amount of repairs needed and whether such repairs can be accomplished within the organization, or evacuate to direct support level of maintenance.
- b. Cleaning. User will keep garments clean, either by individual laundering in warm water with a mild soap or detergent, or by use of installation laundry facilities.
- c. Organizational Repair. Repair to be accomplished at organizational level will be hand sewing of rips, tears, loose seams and damaged buttonholes. Replacement buttons will match the original buttons in color, design and size of the type specified in Section III.
- d. Direct Support Maintenance.
 - (1) Preliminary examination and cleaning. Dirt, mud, dust, spots, stains and other foreign matter will be removed with a brush or by laundering. Rotten Items will be discarded. Seams will be tested by grasping the item with both hands and pulling at right angles to the seams. Areas to be repaired shall be marked with crayon. Non-specification and personal marks shall be erased or obliterated.
 - (2) Cleaning. Clothing will be processed in Army laundries in accordance with established cleaning practices as prescribed in FM 10-280.
 - (3) Repairs.
 - (a) Stitching and restitching. Use machine sewing where possible for all stitching and restitching. Backstitch or bartack all stitching at ends at least 1 inch to prevent raveling. Maintain proper thread tension to prevent loose stitching and to imbed the lock in the center of the material sewn. When type 401 stitch is used, place looper thread on the underside. The type of stitch, thread size, and stitches per inch are listed below.

16-6. REPAIR AND MAINTENANCE-Continued

USE	STITCH	NEEDLE/BOBBIN THREAD	STITCHES PER INCH
General	301 or 401	50/3 - 50/3	10-14
Buttonhole	–	50/3 - 50/3	52-56 per Buttonhole
Button	101 or 301	30/3	14-16
Bartack	–	50/3 - 50/3	28 per Bartack

- (b) Patching and darning. Repair small holes and tears not exceeding 1/2 inch (1.27 cm) in diameter by darning. Patch holes, rips, tears and areas worn thin which are greater than 1/2 inch (1.27 cm) in any dimension. The patch will match as nearly as possible the material being repaired in type, quality, and color. Cut away the damaged area and turn edges under not less than 1/2 inch (1.27 cm) and not more than 1 inch (2.54 cm) around the perimeter of the opening, with not less than 3/8 inch (0.952 cm) turnunder of all edges except selvage edge. Pre-cut patches to provide symmetry. Inspect previously patched areas and repair if found defective. Cut away all mildew areas and darn, patch or replace. Retack defective bartacks using the original construction method. Replace missing parts or parts damaged beyond repair using original construction method.
- (c) Buttons. Replace missing, damaged, or loose buttons with matching ones. Align buttons with buttonholes.
- (d) Drawcords. Replace missing or defective drawcords in lengths to match original construction.
- (e) Eyelets. Replace missing, loose, badly split, and off-center eyelets. Darn enlarged eyelet hole with No. 50/3 thread. Punch holes receiving eyelets smaller than outside diameter of eyelet barrel so that barrel must be forced through material.
- (f) Sleeve closure. Replace defective elastic webbing in sleeve.
- (g) Flaps. Repair or replace torn, missing, or defective flaps. Restitch ripped seams or loose stitching.
- (h) Pockets. Restitch loose or ripped trouser hip pockets. Replace missing or defective pockets with ones fabricated of like material, size, and design of the original.
- (i) Binding and facing. Restitch defective stitching in binding and facing. Replace torn, frayed or missing bindings and facings or such parts that have mildewed or rotted.

16-7. RESIZING

After cleaning and repair, resize garments according to sizes listed in the appropriate sizing table (tables 16-3 and 16-4). When garments vary in size from original markings, obliterate old marking and mark proper size with indelible pencil or waterproof ink. When measurements do not correspond to the measurements listed, re-label to next lowest size.

16-7. RESIZING-Continued

Table 16-3. Finished Measurements of Desert Night Parka

SIZE	1/2 CHEST	SLEEVE LENGTH	BACK LENGTH
X-Small	21 3/8	24 1/8	43 5/8
Small	23 3/8	24 3/8	44 1/8
Medium	25 3/8	24 5/8	44 5/8
Large	27 3/8	24 7/8	45 1/8
X-Large	29 3/8	25 1/8	45 5/8
Tolerance	± 1/2	± 1/2	± 1/4

1/2 Chest - With parka closed, measure across front from folded edge to folded edge at base of armhole.
 Sleeve length - Measure along underarm seam from base of armhole to bottom edge of sleeve.
 Back length - Measure from center of hood joining seam to bottom of parka.

Table 16-4. Finished Measurements of Desert Night Trousers

SIZE	1/2 WAIST	TOLERANCE
X-Small	15 3/4	± 1/2
Small	17 3/4	± 1/2
Medium	19 3/4	± 1/2
Large	21 3/4	± 1/2
X-Large	23 3/4	± 1/2
Lengths	Inseam	
Short	30 1/2	± 3/4
Regular	32 1/2	± 3/4
Long	34 1/2	± 3/4

1/2 Waist - Measure along top of waist from folded edge to folded edge with fly closed Inseam - Measure from center of crotch seam to bottom of leg.

Section III. MATERIALS - Continued

(1) SMR CODE	(2) NATIONAL STOCK NUMBER	(3) DESCRIPTION	(4) UNIT OF ISSUE
PAFZZ	8305-01-102-6775	Cloth, Twill, Camouflage Pattern. Cotton and Nylon. Conforming to Class 2 of MIL-C-44034	YD
PAFZZ	8310-00-262-0094	Thread, Cotton, Gimp, OD S-1. Type I or II, Size 8. Conforming to V-T-280.	SL
PAFZZ	8310-01-066-0973	Thread, Cotton-Covered, Polyester, Ticket No 5/3 ply. OD S-1, Conforming to MIL-T-43548.	CE
PAFZZ	8315-00-899-0029	Buttons Sewing Hole, Composition, Type II, Class D, Style 26, 30 Line, Olive Green BP, Cable No. 62016 Conforming to V-B-871.	GR
PAFZZ	8315-00-267-3125	Braid, Textile, Cotton, 1/8 in. Dia. Olive Green Shade OG-107, Conforming to Type IV, Class 2 of MIL-B-371.	YD
XBFZZ	Purchase Locally	Webbing, Elastic, 5/16 in Wide. Unbleached, Conforming to Type II, Class 1 of JJ-W-155,	YD
XBFZZ		Cord, Elastic, 5/16 In. Dia., Olive Green Shade 106 Conforming to Type II of MIL-C-43701.	YD
PAFZZ	8315-00-255-7673	Tape Textile, Nylon, Olive Drab No. 7, Conforming to Type III of MIL-T-5038.	YD
PAFZZ	8315-00-106-5973	Fastener, Tape, Hook, 1 inch. Olive Green, 106, Conforming to Type II, Class 1 of MIL-F-21840.	YD
PAFZZ	8315-00-106-5974	Fastener, Tape Pile, 1 inch, Olive Green, 106, Conforming to Type II, Class 1 of MIL-F-21840.	YD
PAFZZ	8315-01-010-7204	Fastener, Tape, Pile, 5/8 In. Olive Green, 106, Conforming to Type II, Class 1 of MIL-F-21840	YD
PAFZZ	8315-01-010-7203	Fastener, Tape, Hook, 5/8 In. Olive Green, 106, Conforming to Type II, Class 1 of MIL-F-21840.	YD

CHAPTER 17

MAINTENANCE, WET WEATHER PARKA & TROUSERS

Section I. INTRODUCTION

17-1. SCOPE

This chapter prescribes the procedures and Instructions that cover the materials, methods, and the repair of the Wet Weather Parka & Trousers.

17-2. COMMODITY SPECIFICATION

a. Items.

SPECIFICATION	ITEM
M I L-P-43907	Parka and Trouser, Wet Weather

b. Components

SPECIFICATION	ITEM
V-F-106 V-T-285 UU-P-268 DDD-L-20 PPP-B-636 MIL-E-20652/1 MIL-C-43303 MIL-T-43566 MIL-C-43906	Fasteners, Slide, Interlocking Thread, Polyester Paper, Kraft, Wrapping Label, For clothing, Equipment, Tentage, (General Use) Boxes, Shipping, Fiberboard Eyelets, Metallic, Rolled Flange Type, and Eyelet Washer Cord, Elastic Cotton Tape, Textile Cotton, General Purpose, Natural or in Colors Cloth, Coated, Nylon, Polyurethane, Double Coated

17-2. IDENTIFICATION AND DESCRIPTION

Parka and Trousers, Wet Weather, Standard A item NSN 8405-00-001-1547 and 8405-00-001-8025 respectively. The Parka and Trousers are fabricated from a 78 g/m² (2.3 oz/yd) plain weave nylon fabric coated on the outside with a 72 g/m² layer of cross linked polyurethane (2.1 oz/yd²) and on the inside with 51.8 g/m² (1.5 oz/yd²) layer of cross linked polyurethane, olive green 207 in color, with an infrared reflectance of 219 at 1 micron. The Wet Weather Parka has a regular sleeve construction, is mid-thigh in length with an attached hood; a full zipper front, velcro closures on each sleeve cuff and at the juncture between the front of the hood and the body of the Parka, slash-through pocket openings, drawcords in the hood facing opening; and an elastic drawcord at the bottom. The Wet Weather trousers are ankle length with drawcords in each leg hem; slash-through pocket opening, suspender loops, waist to crotch fly front opening with no zipper; and a waist drawcord (figure 17-1 and 17-2).

17-3. IDENTIFICATION AND DESCRIPTION-Continued

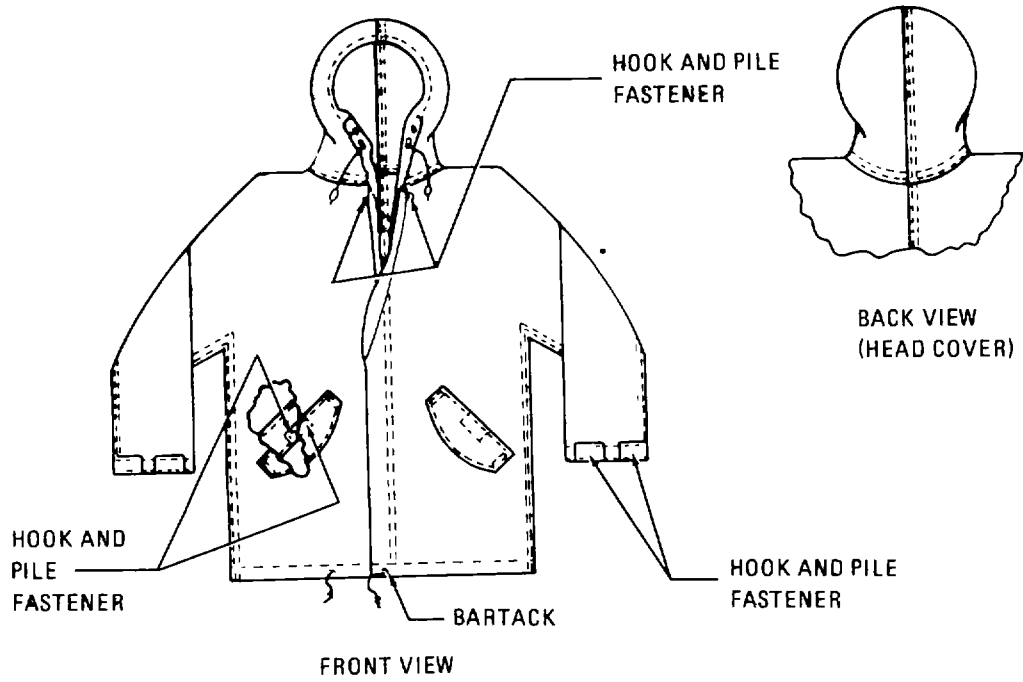

Figure 17-1. Parka, Wet Weather

17-3. IDENTIFICATION AND DESCRIPTION-Continued

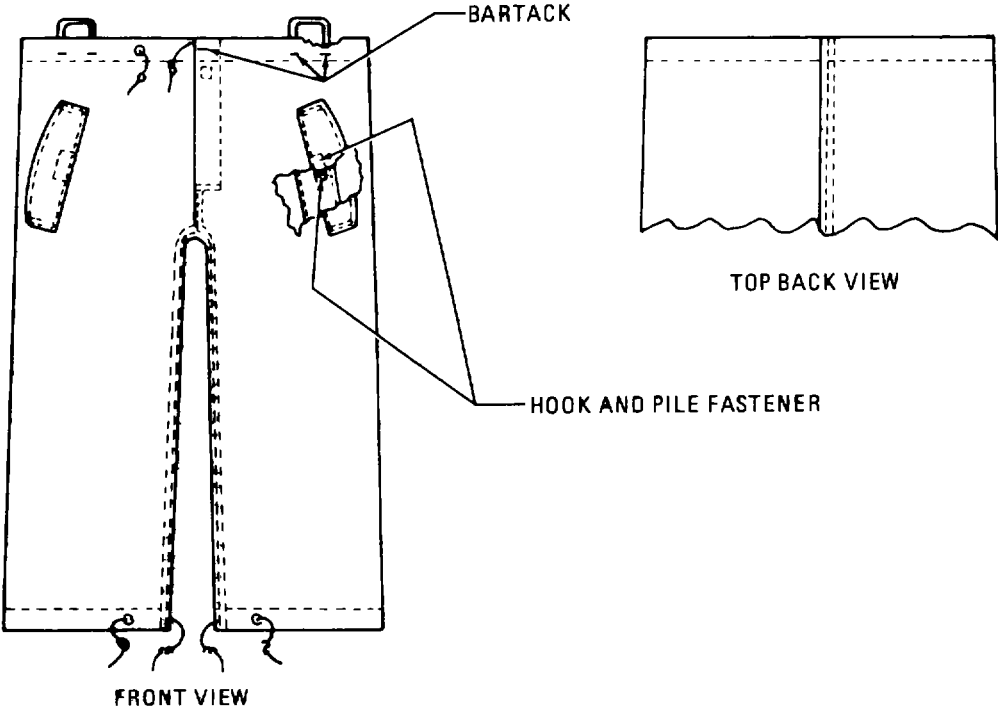

Figure 17-2. Trousers, Wet Weather

Section II. REPAIR PROCEDURES

17-4. MATERIALS

Materials used in the repair of Parka and Trousers, Wet Weather will be new materials as specified in Section III.

17-5. CLASSIFICATION

Refer to Chapter 1 for serviceability classification for the Parka and Trousers, Wet Weather.

17-6. REPAIR AND MAINTENANCE

Prior to repair each item will be Inspected to determine the amount of repair necessary. Repairs will be made as fully as skills, facilities, funds and local conditions permit.

- a. Repair procedure for the polyurethane double coated Parka and Trousers, Wet Weather - Patching and Maintenance.
 - (1) Cleaning: Do not machine wash or machine dry the Parka & Trousers, Wet Weather. Clean with a clean cloth, shampoo by hand with a soft bristle brush using warm water and a mild soap or synthetic detergent, and rinse thoroughly. Air dry the Parka & Trousers, Wet Weather, do not use direct heat, as this will cause the coated material to dry out and crack.
 - (2) Repair: The repair consists of (1) cleaning the area to be repaired, (2) applying adhesive to patch and to the repair area, and (3) allowing adhesive on both to dry about an hour, and (4) pressing patch in place
 - (3) Preparation of Patch:
 1. Cut a piece of the patching fabric from the kit.
 2. Make It large enough to provide all the patches that will be needed that day.
 3. Clean the lighter coated side (duller and less smooth) by wiping with paper towels, wet (but not dripping) with toluene solvent. Allow to dry.

WARNING

Toluene is a poisonous flammable compound. Use only in well ventilated areas. Avoid repeated and prolonged contact with it. Keep away from heat and open flame.

17-6. REPAIR AND MAINTENANCE-Continued

4. Stir the adhesive and apply to the cleaned side of the piece, spread rapidly with a minimum of strokes. Overlap strokes as little as possible. (When a large piece of fabric is being coated, a paint brush may be used or two or three kit brushes may be taped together.)
5. Dry until the piece can be cut into patches without the adhesive fouling the shears. This may take an hour, but might be as little as 20 minutes on warm dry days.
6. Cut patches in the required sizes and shapes as needed (generally rectangular). Round off corners. The patch should cover the damage and extend into the surrounding area of the garment about 3/4 inch (1.91 cm) in all directions.
7. These adhesive coated patches may then be applied in the subsequent patching procedure at any time during the rest of the day.

NOTE

When making one patch only, proceed as above, except apply the adhesive after the one patch is cut. Hold the patch down with the point of a small stick, pencil, or other similar device and apply the adhesive by brushing outwards from the center of the patch all around.

(4) Prepare Punctured, Torn, or Work Area:

1. If heavily soiled, pre-clean the damaged area. If area is wetted with water or other cleaning fluid, dry thoroughly.
2. Trim off any badly frayed or curled edges.
3. Spread out the garment area to be patched on a flat work surface.
4. Where the hole to be patched is wide or where there is a large porous area to be patched, slip the polyethylene film from the kit) under the garment layer to be patched. This will help keep the adhesive from messing up the garment and work surface.
5. Wipe the area to be patched, using a toluene wetted cloth or paper towel. Dry.
6. Using the patch from (c) above as a template, place it in what will be its final position on the torn area and make a tracing along its border. Use a No. 2 or soft pencil for tracing.
7. Remove the patch and apply one even coat of the adhesive within the tracing and just including the tracing line. Do not brush directly into open tears and holes. Rapidly brush with a minimum of strokes.
8. Dry until no sign of wetness or tackiness (generally an hour or less)

17-6. REPAIR AND MAINTENANCE - Continued

(5) Patch Assembly:

1. Carefully set the patch from step (3) exactly on the marked prepared area in step (4) and press together firmly.
2. Roll the patch with heavy hand pressure using roller provided in the kit then dust the patched area using the talcing bag furnished with the kit.
3. The garment may be worn immediately. If it is to be packed for storage or shipment, allow one hour drying under good ventilation to dissipate solvents completely.

NOTE

The patch will adhere well enough in an hour for ordinary handling but will not withstand snagging or hard abuse.

- b. **Stitching and Restitching.** Machine sew all items being repaired except in emergency repair. Back stitch all stitching at ends to prevent raveling. Properly maintain thread tension to prevent loose stitching. Use same stitching space, and type of seams as that of original construction. Restitch all seams having loose and/or weak thread. Overstitch thread breaks in double lock stitching (type 401) not less than 1/2 inch (1.27 cm) at each break. For information on the various stitch types used, see Federal Standard 751. Thread sizes are found in Section III.
- c. **Drawcords.** Replace missing; frayed, or otherwise defective drawcords cut from braid. Dip the ends of the drawcords in a suitable synthetic resin or type with a nonflammable plastic to prevent fraying.
- d. **Hardware.** Straighten bent and damaged hardware that is otherwise serviceable. Replace hardware such as keepers, eyelets, and snaps that are missing or damaged beyond repair. Retouch or refinish hardware as required. Thoroughly clean hardware of rust, corrosion, dirt, or other foreign matter. Exercise care in replacing or inserting eyelets and fasteners so as not to damage material. Tightly clinch the eyelets without splitting. Tightly clinch fasteners.
- e. **Sealing of Seams.** Apply seam sealant by brush on the stitching and needle holes and under the turned edges of all restitched seams. Allow each coat to become dry to touch before applying the subsequent coat. All restitching except the peripheral hems, the facing piece seams around the face opening of the hood, and the waist drawcord tunnel shall be sealed on the inside of the Parka & Trousers, Wet Weather with a minimum of three coats. Seal outside areas with a minimum of one coat of sealant, except that the earphone cover joining seam and hem shall not be sealed on the outside. Restitching of the waist drawcord tunnel shall be sealed on the outside only with a minimum of three coats of sealant. Restitched hems and facing piece seams around the face openings of the hood shall not be sealed. The coats of sealant shall be allowed to dry before the Parka & Trousers, Wet Weather are folded or before sealed surfaces are allowed to contact other parts of the garment. Adequacy of the drying time may be determined by unfolding a Parka & Trousers, Wet Weather which has been folded and stored for one hour. When the coats of sealant are dry, the sealed seams shall be dusted thoroughly with mica dust. Use sealant prescribed for Parka & Trousers, Wet Weather in Section III.

17-6. REPAIR AND MAINTENANCE - Continued

- f. Marking. Where the original instruction marking has become illegible, the following information will be clearly printed with black marking ink on the underside of the Parka & Trousers, Wet Weather in letters 1/4 inch (0.635 cm) high.

17-7. CONCLUSIONS

These garments are designed to fit over the cold weather uniform. In hot weather, it may be desirable to use smaller sized garments. Since an impermeable material is used in the garments, caution must be taken to avoid moisture build up in the clothing insulation worn underneath the garments. Moisture build up may be reduced in two ways: by adjusting the inner clothing worn to the outdoor temperature and the activity planned and also by utilizing the closures to permit the heat build up under parka and trousers to escape thereby reducing the moisture within the insulating layers.

WARNING

Improper use of these garments can produce heat exhaustion within thirty minutes of hard work.

Section III. MATERIALS

(1) SMR CODE	(2) NATIONAL STOCK NUMBER	(3) DESCRIPTION	(4) UNIT OF ISSUE
XBFZZ		<p>PARKA & TROUSERS, WET WEATHER (NYLON CLOTH, POLYURETHANE DOUBLE COATED)</p> <p>Cloth Nylon 78 g/m² (2.3 oz/yd²) plain weave nylon fabric coated on the outside with a 72 g/m² (2.1 oz/yd²) and on the inside with 51 g/m² (1.5 oz/yd²) of a cross linked polyurethane, olive green 207 in color, with an infrared reflectance. MIL-C-43906.</p> <p>Sources of Supply:</p> <ol style="list-style-type: none"> 1. Gibraltar Industries, Inc., 154 36th Street Brooklyn, New York 11232 2. East Wind Industries, Inc., 13 Barrett Street Clayton, Delaware 19938 3. Winfield Mfg. Co., 350 Fifth Avenue, Suite 6608 New York, N.Y. 10001 <p>CANNIBALIZE FROM UNREPAIRABLE ITEMS</p>	
PAFZZ	5325-00-141-7300	Fastener, Slide, Interlocking, V-F-106, Type 4, Style 8, Size M	EA
PAFZZ	8310-01-063-9282	Thread, Polyester, V-T-285, Type I, Class I, Subclass A, Olive Drab, C.A. 66022, Size E, 3 Ply	CE
PAFZZ	8315-01-010-7203	Fastener Tape, Hook, Synthetic (5/8") MIL-F-21840, Type II, Class 1, OG 106	YD
PAFZZ	8315-00-106-5973	Fastener Tape, Hook, Synthetic (1") MIL-F-21840, Type II, Class 1, OG 106	YD
PAFZZ	8315-01-010-7204	Fastener Tape, Piles, Synthetic (5/8") MIL-F-21840, Type II, Class 1, OG 106	YD
PAOZZ	8315-00-262-2784	Braid, Textile, Tubular, MIL-B-371, Type VII, Class 2, 0.344 inches width, Green 107	YD
PAFZZ		Eyelets, Metallic, Rolled Flange Type M20652/1-BBE117; and Eyelet Washer M20652/1-BBW101	EA
PAFZZ	8305-00-410-8418	Cord, Elastic Cotton, MIL-C-43303, Class 2, Olive Drab 7	YD
PAFZZ	8310-01-066-0973	Thread, Polyester, Cotton-Covered, MIL-T43548, Size 50, 3 Ply, Olive Drab	CE
PCFZZ	8405-00-198-3747	Maintenance Kit, Wet Weather Clothing, MIL-M-43946	EA

CHAPTER 18

MAINTENANCE OF WOMAN'S COAT, SKIRT AND SLACKS

Section I. INTRODUCTION

18-1. SCOPE

This chapter prescribes the procedures and instructions for repair of the woman's coat, Army Green 344, polyester/wool serge; skirt and slacks, Army Green 344, polyester/wool serge.

18-2. COMMODITY SPECIFICATIONS

a. Items.

SPECIFICATION	ITEM
MIL-C-44101 (GL)	Coat, Woman's: Classic Design Cloth, Polyester and Wool; 11.5 oz. Army Green 344, conforming to Type III, Class 3
MIL-S-44102(GL)	Skirt, Woman's: Classic Design Cloth, Type III, Class 3 Polyester/Wool Serge, Army Green 344
MIL-S-44092(GL)	Slacks, Woman's: Classic Design Cloth, Type III, Class 3 Polyester/Wool Serge, Army Green 344

b. Components.

SPECIFICATION	ITEM
C-F-206	Felt Sheet: Cloth, Wool, Press
V-T-280	Thread, Gimp, Cotton, Buttonhole
V-T-295	Thread, Nylon
V-T-301	Thread, Silk
CCC-C-438	Cloth, Buckram, Cotton

18-2. COMMODITY SPECIFICATIONS - Continued

SPECIFICATION	ITEM
MIL-C-297	Cloth, Interlining, Cotton Warp and Spun Hair-Wool or Rayon Filling
MIL-C-326	Cloth, Silesia, Cotton
MIL-C-368	Cloth, Satin Rayon and Cloth Twill Rayon
MIL-B-371	Braid, Textile Tubular
MIL-B-593	Braid, Textile (Flat)
MIL-C-823	Cloth, Serge; Wool, Wool and Nylon, Polyester and Wool
MIL-B-3461	Button, Insignia, Metal, Uniform and Cap
MIL-C-15062	Cloth, Flannel, Wool, Undercollar Cloth
MIL-P-15064	Pads, Shoulder and Sleeve-Head
MIL-C-16375	Cloth, Wigan, Cotton
MIL-T-43548	Thread, Polyester, Cotton-Covered
MIL-T-43718	Cloth, Twill, Polyester; Polyester and Cotton; Polyester and Rayon

18-2. COMMODITY SPECIFICATIONS - Continued

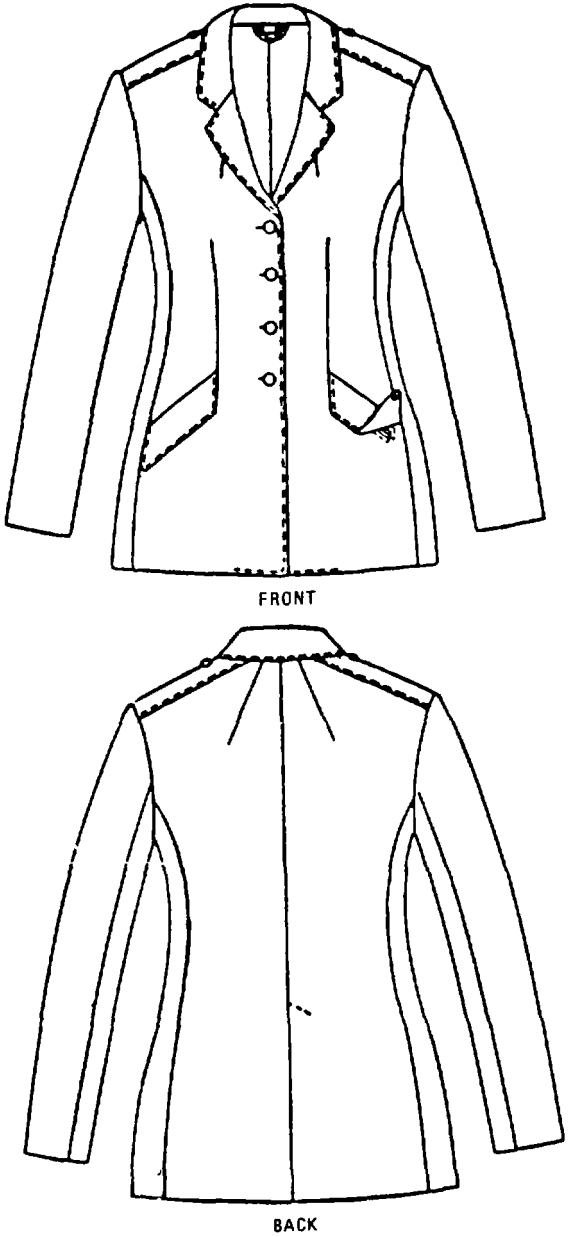

Figure 18-1. Coat, Woman's: Classic Design, Polyester/Wool

18-2. COMMODITY SPECIFICATIONS - Continued

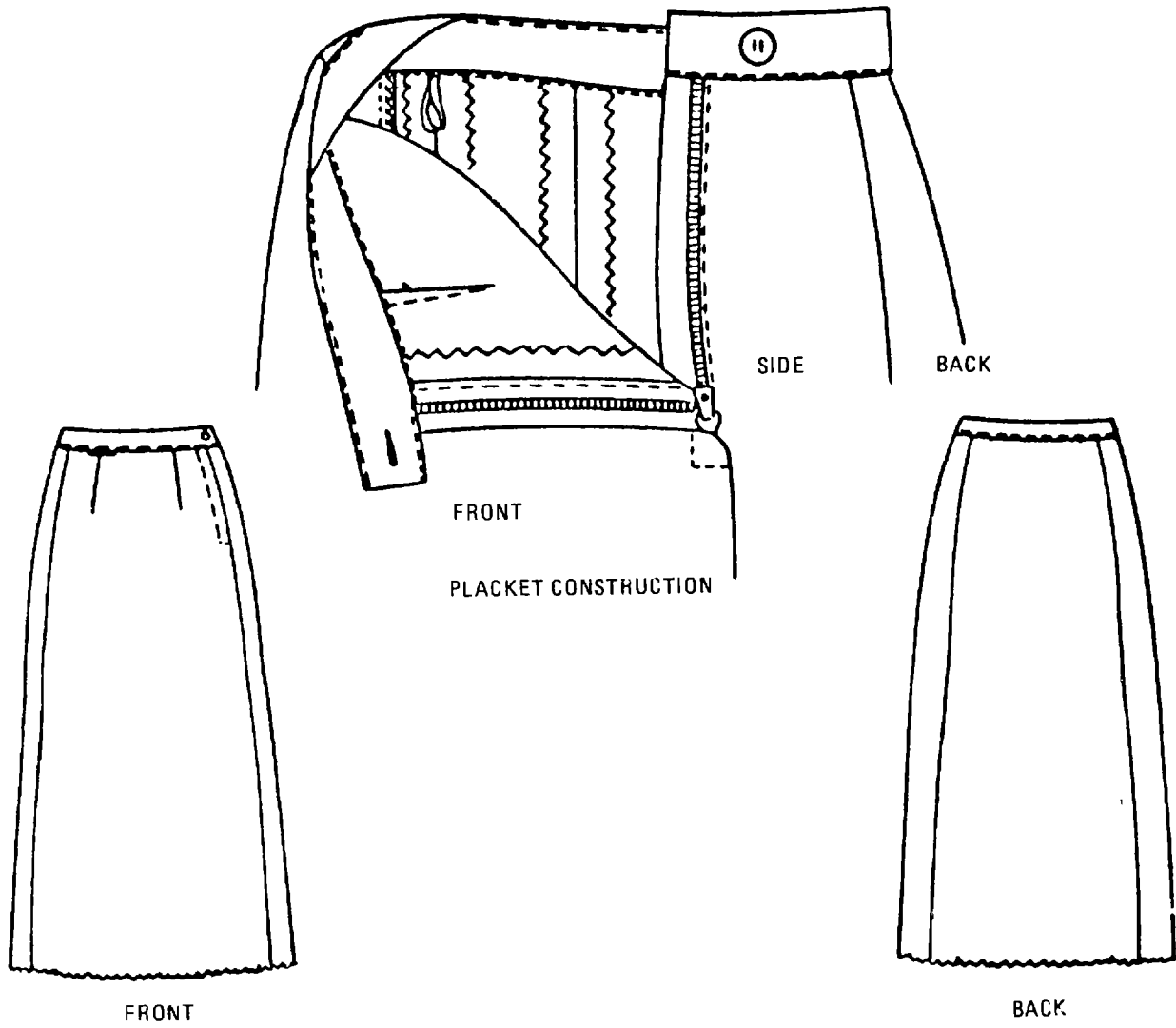

Figure 18-2. Skirt, Woman's: Classic Design, Polyester/Wool

18-2. COMMODITY SPECIFICATIONS - Continued

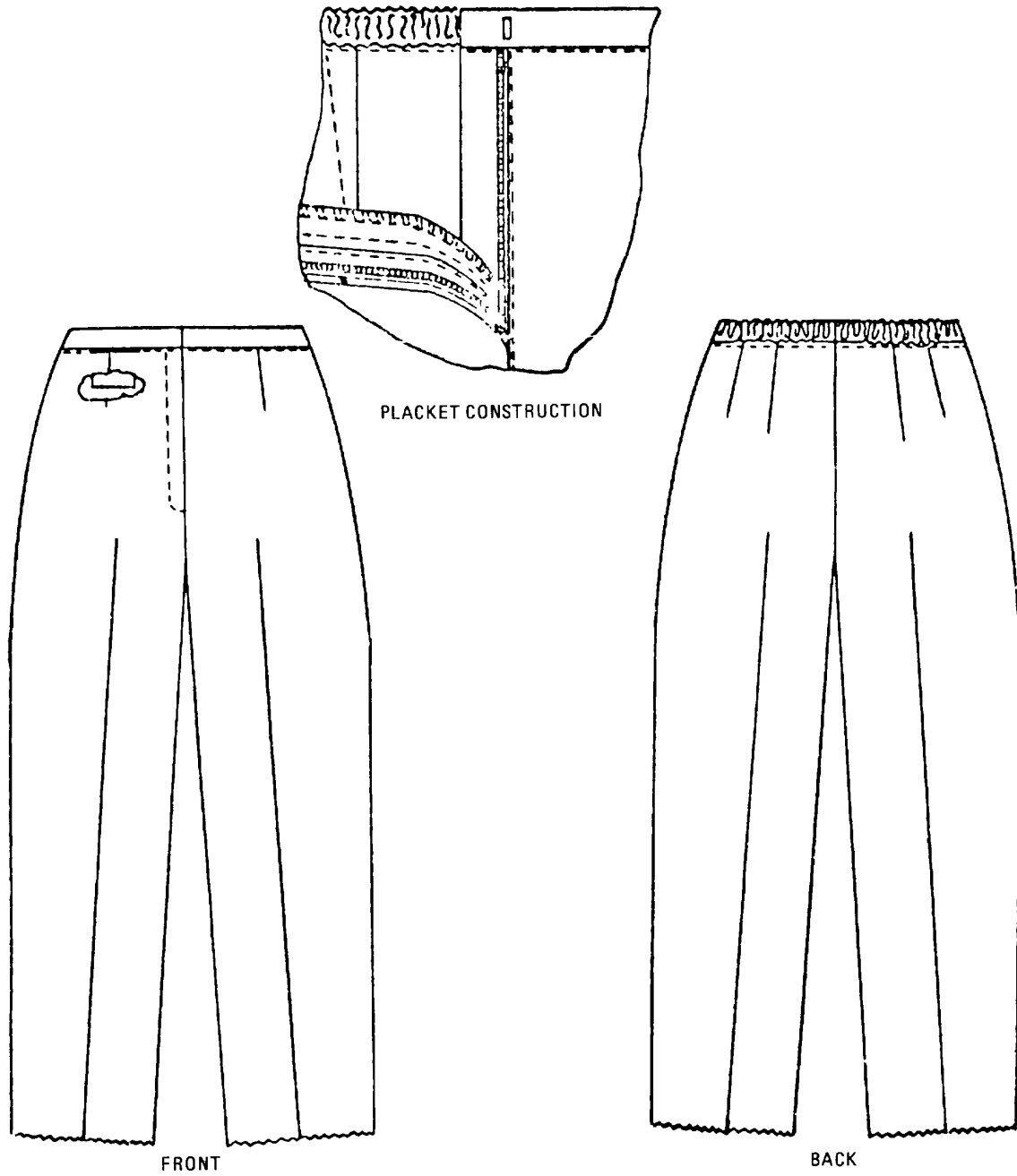

Figure 18-3. Slacks, Woman's: Classic Design, Polyester/Wool

18-3. IDENTIFICATION AND DESCRIPTION

- a. The Coat Woman's, Polyester and Wool Serge, 11.5 oz (326g), Army Green 344, conforming to Type III, Class 3 of MIL-C-823. Fitted, single breasted, four-button design with side body construction: bust and front waist darts, slanted flap pocket, open notch collar, and two-piece sleeves with shoulder loops. The back has neck darts and there is a vent in the center back seam. The coat is fully lined (See figure 18-1 and table 18-1.)
- b. The Skirt, Woman's, Type III, Class 3, Polyester/ Wool Serge Cloth, Army Green 344, conforming to MIL-C-823. The skirt is four-gored with the slide fastener closure at the left side front with a one-button waistband. The skirt has a right-hand front waistband pocket, has darts at the waist in the front and is unhemmed (See figure 18-2 and table 18-2.)
- c. The Slacks, Woman's, Polyester/Wool Serge Cloth, Type III, Class 3, Army Green 344, conforming to MIL-C-823. The slacks have unhemmed straight legs, a fly front with zipper closure, a small front pocket, and hooked waistband which is elasticized across the back. (See figure 18-3 and table 18-3.)

Table 18-1. Coat, Woman's, Classic Design, Polyester/Wool: Schedule of Sizes

NSN	SHORT	1/2 BUST	CROSS BACK	1/2 WAIST	1/2 SWEEP	SLEEVE LENGTH	BACK LENGTH
		Tolerance-3/8"		T-3/8"	T-1/2"	T-3/8"	T-1/2"
8410-01-105-4119	6S	18	13-7/8	13-3/4	20-1/4	21-3/4	25-3/4
8410-01-105-4124	8S	18-1/2	14-1/8	14-1/4	20-3/4	22	26
8410-01-105-4129	10S	19	14-3/8	14-3/4	21-1/4	22-1/4	26-1/4
8410-01-105-4135	12S	19-3/4	14-3/4	15-1/2	22	22-1/2	26-1/2
8410-01-105-4141	14S	20-1/2	15-1/8	16-1/4	22-3/4	22-3/4	26-3/4
8410-01-105-4147	16S	21-1/4	15-1/2	17	23-1/2	23	27
8410-01-105-4153	18S	22-1/4	16	18	24-1/2	23-1/4	27-1/4
	SHORT PLUS						
		T-3/8"	T-3/8"	T-3/8"	T-3/8"	T-1/4"	T-1/4"
8410-01-105-4120	6S +	18	13-7/8	14-1/4	20-3/4	21-3/4	25-3/4
8410-01-105-4125	8S +	18-1/2	14-1/8	14-3/4	21-1/4	22	26
8410-01-105-4130	10S +	19	14-3/8	15-1/4	22-1/4	22-1/4	26-1/4
8410-01-105-4136	12S +	19-3/4	14-3/4	16	23	22-1/2	26-1/2
8410-01-105-4142	14S +	20-1/2	15-1/8	16-3/4	23-3/4	22-3/4	26 3/4
8410-01-105-4148	16S +	21-1/4	15-1/2	17-1/2	24-1/2	23	27

18-3. IDENTIFICATION AND DESCRIPTION - Continued

Table 18-1. Coat, Woman's, Classic Design, Polyester/Wool: Schedule of Sizes - Continued

	REGULAR						
		T-3/8"	T-3/8"	T-3/8"	T-1/2"	T-1/4"	T-1/4"
8410-01-105-4112	4R	17-1/2	13-4/8	13-1/4	19-3/4	22-3/4	26-3/4
8410-01-105-4121	6R	18	13-7/8	13-3/4	20-1/4	23	27
8410-01-105-4126	8R	18-1/2	14-1/8	14-1/4	20-3/4	23-1/4	27-1/4
8410-01-105-4131	10R	19	14-3/8	14-3/4	21-1/4	23-1/2	27-1/2
8410-01-105-4137	12R	19-3/4	14-3/4	15-1/2	22	23-3/4	27-3/4
8410-01-105-4143	14R	20-1/2	15-1/8	16-1/4	22-3/4	24	28
8410-01-105-4149	16R	21-1/4	15-1/2	17	23-1/2	24-1/4	28-1/4
8410-01-105-4154	18R	22-1/4	16	18	24-1/2	24-1/2	28-1/2
8410-01-105-4157	20R	23-1/4	16-1/2	19	25-1/2	24-3/4	28-3/4
	REGULAR PLUS						
		T-3/8"	T-3/8"	T-3/8"	T-1/2"	T-1/4"	T-1/4"
8410-01-105-4133	4R +	17-1/2	13-4/8	13-3/4	20-1/4	22-3/4	26-3/4
8410-01-105-4122	6R +	18	13-7/8	14-1/4	20-3/4	23	27
8410-01-105-4127	8R +	18-1/2	14-1/8	14-3/4	21-1/4	23-1/4	27-1/4
8410-01-105-4132	10R +	19	14-3/8	15-1/4	22-1/4	23-1/2	27-1/2
8410-01-105-4138	12R +	19-3/4	14-3/4	16	23	23-3/4	27-3/4
8410-01-105-4144	14R +	20-1/2	15-1/8	16-3/4	23-3/4	24	28
8410-01-105-4150	16R +	21-1/4	15-1/2	17-1/2	24-1/2	24-1/4	28-1/4

18-3. IDENTIFICATION AND DESCRIPTION - Continued

Table 18-1. Coat, Woman's, Classic Design, Polyester/Wool Schedule of Sizes - Continued

		LONG					
		T-3/8"	T-3/8"	T-3/8"	T-1/2"	T-1/4"	T-1/4"
8410-01-105-4114	4L	17-1/2	13-5/8	13-1/4	19-3/4	24-1/4	28
8410-01-105-4123	6L	18	13-7/8	13-3/4	20-1/4	24-1/2	28-1/4
8410-01-105-4128	8L	18-1/2	14-1/8	14-1/4	20-3/4	24-3/4	28-1/2
8410-01-105-4133	10L	19	14-3/8	14-3/4	21-1/4	25	28-3/4
8410-01-105-4139	12L	19-3/4	14-3/4	15-1/2	22	25-1/4	29
8410-01-105-4145	14L	20-1/2	15-1/8	16-1/4	22-3/4	25-1/2	29-1/4
8410-01-105-4151	16L	21-1/4	15-1/2	17	23-1/2	25-3/4	29-1/2
8410-01-105-4155	18L	22-1/4	16	18	24-1/2	26	29-3/4
8410-01-105-4158	20L	23-1/4	16-1/2	19	25-1/2	26-1/4	30-1/8
		LONG PLUS					
		T-3/8"	T-3/8"	T-3/8"	T-1/2"	T-1/4"	T-1/4"
8410-01-105-4134	10L +	19	14-3/8	15-1/4	22-1/4	25	28-3/4
8410-01-105-4140	12L +	19-3/4	14-3/4	16	23	25-1/4	29
8410-01-105-4146	14L +	20-1/2	15-1/8	16-3/4	23-3/4	25-1/2	29-1/4
8410-01-105-4152	16L +	21-1/4	15-1/2	17-1/2	24-1/2	25-3/4	29-1/2
8410-01-105-4156	18L +	22-1/4	16	18-1/2	25-1/2	26	29-3/4
		EXTRA LONG					
		T-3/8"	T-3/8"	T-3/8"	T-1/2"	T-1/4"	T-1/4"
8410-01-105-4115	8 X L	18-1/2	14-1/8	14-1/4	20-3/4	26-1/4	29-3/4
8410-01-105-4116	10 X L	19	14-3/8	14-3/4	21-1/4	26-1/2	30
8410-01-105-4117	12 X L	19-3/4	14-3/4	15-1/2	22	26-3/4	30-1/4
8410-01-105-4118	14 X L	20-1/2	15-1/8	16-1/4	22-3/4	27	30-1/2

18-3. IDENTIFICATION AND DESCRIPTION - Continued

Table 18-2. Skirt, Woman's, Classic Design, Polyester/Wool: Schedule of Sizes

NSN	SHORT	1/2 WAIST	HIP	SWEEP	LENGTH
		TOL-1/4"	TOL-3/8"	TOL-3/8"	TOL-1/2"
8410-01-105-4721	6S	12	18-1/2	22-3/4	26-1/8
8410-01-105-4724	8S	12-1/2	19	23-1/4	26-3/8
8410-01-105-4729	10S	13	19-1/2	23-3/4	26-5/8
8410-01-105-4734	12S	13-3/4	20-1/4	24-1/2	26-7/8
8410-01-105-4739	14S	14-1/2	21	25-1/4	27-1/8
8410-01-105-4744	16S	15-1/4	21-3/4	26	27-3/8
8410-01-105-4749	18S	16-1/4	22-3/4	27	27-5/8
8410-01-105-4752	20S	17-1/4	23-3/4	28	27-7/8
	SHORT PLUS				
		TOL-1/4"	TOL-3/8"	TOL-3/8"	TOL-1/2"
8410-01-105-4714	6S +	12-1/2	19	23-1/4	26-1/8
8410-01-105-4725	8S +	13	19-1/2	23-3/4	26-3/8
8410-01-105-4730	10S +	13-1/2	20-1/2	24-3/4	26-5/8
8410-01-105-4735	12S +	14-1/4	21-1/2	25-1/2	26-7/8
8410-01-105-4740	14S +	15	22	26-1/4	27-1/8
8410-01-105-4745	16S +	15-3/4	22-3/4	27	27-3/8
	REGULAR				
		TOL-1/4"	TOL-3/8"	TOL-3/8"	TOL-1/2"
8410-01-105-4722	6R	12	18-1/2	22-3/4	27-5/8
8410-01-105-4726	8R	12-1/2	19	23-1/4	27-7/8
8410-01-105-4731	10R	13	19-1/2	23-3/4	28-1/8
8410-01-105-4736	12R	13-3/4	20-1/4	24-1/2	28-3/8
8410-01-105-4741	14R	14-1/2	21	25-1/4	28-5/8
8410-01-105-4746	16R	15-1/4	21-3/4	26	28-7/8
8410-01-105-4750	18R	16-1/4	22-3/4	27	29-1/8
8410-01-105-4753	20R	17-1/4	23-3/4	28	29-3/8

18-3. IDENTIFICATION AND DESCRIPTION - Continued

Table 18-2. Skirt, Woman's, Classic Design, Polyester/Wool: Schedule of Sizes - Continued

	REGULAR PLUS				
		TOL-1/4"	TOL-3/8"	TOL-3/8"	TOL-1/2"
8410-01-105-4715	6R +	12-1/2	19	23-1/4	27-5/8
8410-01-105-4727	8R +	13	19-1/2	23-3/4	27-7/8
8410-01-105-4732	10R +	13-1/2	20-1/2	24-3/4	28-1/8
8410-01-105-4737	12R +	14-1/4	21-1/4	25-1/2	28-3/8
8410-01-105-4742	14R +	15	22	26-1/4	28-5/8
8410-01-105-4747	16R +	15-3/4	22-3/4	27	28-7/8
	LONG				
		TOL-1/4"	TOL-3/8"	TOL-3/8"	TOL-1/2"
8410-01-105-4723	6L	12	18-1/2	22-3/4	29-3/8
8410-01-105-4728	8L	12-1/2	19	23-1/4	29-5/8
8410-01-105-4733	10L	13	19-1/2	23-3/4	29-7/8
8410-01-105-4738	12L	13-3/4	20-1/4	24-1/2	30-1/8
8410-01-105-4743	14L	14-1/2	21	25-1/4	30-3/8
8410-01-105-4748	16L	15-1/4	21-3/4	26	30-5/8
8410-01-105-4751	18L	16-1/4	22-3/4	27	30-7/8
8410-01-105-4754	20L	17-1/4	23-3/4	28	31-1/8
	LONG PLUS				
		TOL-1/4"	TOL-3/8"	TOL-3/8"	TOL-1/2"
8410-01-105-4716	10L +	13-1/2	20-1/2	24-3/4	29-7/8
8410-01-105-4717	12L +	14-1/4	21-1/4	25-1/2	30-1/8
8410-01-105-4718	14L +	15	22	26-1/4	30-3/8
8410-01-105-4719	16L +	15-3/4	22-3/4	27	30-5/8
8410-01-105-4720	18L +	16-3/4	23-3/4	28	30-7/8

18-3. IDENTIFICATION AND DESCRIPTION - Continued

Table 18-3. Slacks, Woman's, Classic Design, Polyester/Wool: Schedule of Sizes

NSN	SHORT	1/2 WAIST	1/2 HIP	OUTSEAM
		TOL-3/8"	TOL-3/8"	TOL-1/2"
8410-01-105-4668	6S	11-1/2	18-1/4	41-1/8
8410-01-105-4673	8S	12	18-3/4	41-3/8
8410-01-105-4678	10S	12-1/2	19-1/4	41-5/8
8410-01-105-4684	12S	13-1/4	20	41-7/8
8410-01-105-4690	14S	14	20-3/4	42-1/8
8410-01-105-4696	16S	14-3/4	21-1/2	42-3/8
8410-01-105-4702	18S	15-3/4	22-1/2	42-5/8
8410-01-105-4706	20S	16-3/4	23-1/2	42-7/8
	SHORT PLUS			
		TOL-3/8"	TOL-3/8"	TOL-1/2"
8410-01-105-4669	6S +	12	19-1/4	41-1/8
8410-01-105-4674	8S +	12-1/2	19-3/4	41-3/8
8410-01-105-4679	10S +	13	20-1/4	41-5/8
8410-01-105-4685	12S +	13-3/4	21	41-7/8
8410-01-105-4691	14S +	14-1/2	21-3/4	42-1/8
8410-01-105-4697	16S +	15-1/4	22-1/2	42-3/8
	REGULAR			
		TOL-3/8"	TOL-3/8"	TOL-1/2"
8410-01-105-4670	6R	11-1/2	18-1/4	43-1/2
8410-01-105-4675	8R	12	18-3/4	43-3/4
8410-01-105-4680	10R	12-1/2	19-1/4	44
8410-01-105-4686	12R	13-1/4	20	44-1/4
8410-01-105-4692	14R	14	20-3/4	44-1/2
8410-01-105-4698	16R	14-3/4	21-1/2	44-3/4
8410-01-105-4703	18R	15-3/4	22-1/2	45
8410-01-105-4707	20R	16-3/4	23-1/2	45-1/4

18-3. IDENTIFICATION AND DESCRIPTION - Continued

Table 18-3. Slacks, Woman's, Classic Design, Polyester/Wool: Schedule of Sizes - Continued

	REGULAR PLUS			
		TOL-3/8"	TOL-3/8"	TOL-1/2"
8410-01-105-4671	6R +	12	19-1/4	43-1/2
8410-01-105-4676	8R +	12-1/2	19-3/4	43-3/4
8410-01-105-4681	10R +	13	20-1/4	44
8410-01-105-4687	12R +	13-3/4	21	44-1/4
8410-01-105-4693	14R +	14-1/2	21-3/4	44-1/2
8410-01-105-4699	16R +	15-1/4	22-1/2	44-3/4
	LONG			
		TOL-3/8"	TOL-3/8"	TOL-1/2"
8410-01-105-4672	6L	11-1/2	18-1/4	46-7/8
8410-01-105-4677	8L	12	18-3/4	47-1/8
8410-01-105-4682	10L	12-1/2	19-1/4	47-3/8
8410-01-105-4688	12L	13-1/4	20	47-5/8
8410-01-105-4694	14L	14	20-3/4	47-7/8
8410-01-105-4700	16L	14-3/4	21-1/2	48-1/8
8410-01-105-4704	18L	15-3/4	22-1/2	48-3/8
8410-01-105-4708	20L	16-3/4	23-1/2	48-5/8
	LONG PLUS			
		TOL-3/8"	TOL-3/8"	TOL-1/2"
8410-01-105-4683	10L +	13	20-1/4	47-3/8
8410-01-105-4689	12L +	13-3/4	21	47-5/8
8410-01-105-4695	14L +	14-1/2	21-3/4	47-7/8
8410-01-105-4701	16L +	15-1/4	22-1/2	48-1/8
8410-01-105-4705	18L +	16-1/4	23-1/2	48-3/8

Section II. REPAIR PROCEDURES

18-4. MATERIALS

Materials used in the repair of coats, skirts and slacks shall be serviceable materials recovered from similar salvaged items when authorized, or will be new materials as specified in Section III. New materials will be requisitioned from stock under the stock number and/or item description and shall conform to the appropriate specification. When not available from stock, materials may be purchased locally that conform as closely as possible to the standard material.

18-5. CLASSIFICATION

Refer to Chapter 1 for serviceability classification of coats, skirts and slacks.

18-6. REPAIR AND MAINTENANCE

Prior to repair operation each item shall be inspected by qualified personnel to determine the amount of repair necessary. The following methods shall be observed as fully as skills, facilities, funds, and local conditions permit. The sequence of operations shall be determined by the repairing organization, unless otherwise prescribed.

- a. Inspection. Inspect all items to determine the amount of repairs needed and whether such repairs can be accomplished within the organization, or evacuate to direct support level of maintenance.
- b. Repair. Repairs to be accomplished by hand sewing at organizational maintenance are limited to replacing missing or damaged buttons and attaching loose belt loops. Replacement buttons will match the original buttons in color, design and size, of the type specified in Section III
- c. Cleaning. Remove dirt, dust, and other foreign matter by brushing. Stains in wool coats, skirts and slacks should be removed in accordance with table 18-5.
- d. Direct support maintenance.
 - (1) Preliminary examination and cleaning. Dust, mud, dirt, spots, stains, and other foreign matter shall be removed with brush or by laundering. Mildew and rotten items shall be discarded. Seams shall be tested by grasping the item with both hands and pulling at right angles to the seam. Areas to be repaired shall be marked with crayon. Nonspecification and personnel marks shall be erased or obscured.
 - (2) Cleaning (drycleaning). Items that require drycleaning and/or mothproofing will be processed in Army drycleaning facilities in accordance with label instructions. When such facilities are not available, items shall be drycleaned by contract with private industry in accordance with accepted commercial drycleaning practices

18-6. REPAIR AND MAINTENANCE - Continued

(3) Repair.

- (a) Stitching and restitching. Use machine sewing whenever possible for all stitching and restitching items. Backstitch or bartack all stitching at ends to prevent raveling. Maintain proper thread tension to prevent loose stitching and to imbed the lock in the center of the material sewn. Overlock all thread breaks in overedge stitching not less than 3/4 inch (1.91 cm) at each break. Re-stitch seams containing loose and/or broken threads. Overstitch thread breaks in type 301 stitching not less than 1/2 inch (1.27 cm) at each break. For illustrations of the various types of stitches used, see FED STD 751. Thread used will be Army Green, Shade E, Cable No. 66034, except for seaming sleeve braid where Black Shade AA, Cable No. 66034, thread will be used. Thread size shall conform to V-T-276 of the types and sizes in table 18-4.

Table 18-4. Stitching Instruction.

Use	Stitch	Type	Ticket No.	Ply	Stitches/Inch
Seaming of Coat General	301	1A3	50	3	12-16
Bartack		1A3	50	3	21
Button Sewing	301	1A3	20	4	14-16
Braid Stitching		1A3	50	3	12-16
Overedge	503 or 504	1A3	50	3	6-8
Buttonholes		1A3	50	3	46-52

- (b) Patching and darning. Repair rips and tears that will not be visible when garment is worn. Repair small rips and tears not more than 1/2 inch (1.27 cm) across their greatest dimension by drawing the edges together and darning with zig-zag stitch. Repair holes, rips and tears greater than 1/2 inch (1.27 cm) by patching when acceptable to appearance standards. Cut patch from material matching that being repaired and insert under the damaged area. Cut patch large enough to extend from 1/4 to 3/8 inch (0.635 to 0.952cm) around the perimeter of the opening. Darn or patch area in waistband, vent openings, or other areas that will not be visible when garment is worn.

18-6. REPAIR AND MAINTENANCE - Continued

- (c) Button. Replace missing, broken, or damaged buttons with matching ones (see Section III). Align buttons with buttonholes.
- (d) Buttonholes. Fashion buttonholes of the eyelid-end square bar type over gimp to properly fit and move face over button. Repair buttonholes by reshaping the enlarged buttonhole before reworking and then pull in to shape by hand or machine stitch a small reinforcement patch to the underside of the garment and rework the buttonhole through the patch. Tack ends of buttonhole securely Use thread and stitching listed in (a) above.
- (e) Pockets and flaps. Repair or replace torn, missing or defective pockets and flaps Restitch ripped seams on flaps and pockets. Darn small holes and tears when necessary; patch slightly larger holes, if the darning and patching will not be visible when garment is worn.
- (f) Vents. Darn or patch holes, tears, and frays that will not be visible when garment is worn.
- (g) Shoulder loops. Restitch or replace loose, missing, or defective shoulder loops. Whenever the outer facing of the shoulder loop shows unacceptable defects, reverse, and place on opposite shoulder, if possible, provided shade of the fabric matches. Fabricate replacement shoulder loops from cloth conforming to the basic material of the garment.
- (h) Lining. Repair holes, tears, or other defects in linings by darning or patching. Darn any small holes or tears before any patches are sewn on. Darn and cover holes at armholes with a patch of lining material in a shape of a sweat shield with raw edges turned in and felled to armhole and lining.
- (i) Slide fastener. Replace missing or damaged slide fasteners of the type prescribed in Section III.
- (j) Hangers and button loops. Replace or re sew missing or loose hanger loops and button loops with like material.
- (k) Snap fasteners. Replace missing or damaged snap fasteners with the type prescribed in Section III.
- (l) Buckles. Replace missing or damaged buckles with the type prescribed in Section III.

18-7. RESIZING

After cleaning and repairs have been accomplished, resize items according to sizes listed in the appropriate table (Table 18-1 through 18-3). When garments vary in size from original markings, obliterate old marking and mark proper size with indelible pencil or waterproof ink. When measurements do not correspond to a size listed, relabel to nearest breast and back length size. For example, if the coat measures 22 inches (55.9 cm) in the half-breast and 29-13/16 inches (75.7 cm) in the back, mark on the coat label "size 40". Coats in good wearable condition should not be sent to the property disposal officer because the back and breast measurements are off fractions of an inch.

18-8. WORKMANSHIP

All work shall be accomplished by personnel skilled in the particular trade applicable to their duties in the repair of the subject items. Patches will be tightly sewn and all reseaming will be secure and free of loose or broken thread. Buttons will be securely and properly attached. The finished Item shall be complete, clean, well repaired, and free from all defects affecting its serviceability and appearance.

18-9. INSPECTION

The inspection or quality control unit is responsible for determining compliance with repair instructions and requirement for classification. In-process inspection will be performed for quality of workmanship and correct application of repair procedures. The completed item will be inspected for serviceable condition and appearance to insure against return of substandard product to supply channels.

18-10. TYPE OF STAIN

Table 18-5. Procedures for stain removal.

STAIN	PROCEDURES FOR WOOL FABRIC
Gravy	Rub stain with cold water, place a pad or cloth underneath fabric to absorb stain, and rub stain with cleaning fluid. If any stain remains, dry the fabric and rub with soap or synthetic detergent solution. Do not rub excessively as this may damage the finish of the garment.
Food	Dampen stained area with water. Apply soap or synthetic detergent solution (with ammonia, if available), tamp with brush, and flush with water.
Milk	Same as procedure for food stain.
Fruit or fruit juices	Flush stain area with lukewarm water. Apply soap or synthetic detergent solution, tamp with brush, and flush out with water. (If applicable, apply lemon juice or vinegar and flush thoroughly with water.)
Grease or oil	Scrape off top stain, then saturate stained area with cleaning fluid, tamp with brush and flush out with cleaning fluid.
Blood	Dampen area that is stained with water. Apply soap or synthetic detergent solution (with ammonia, if available). Tamp with brush and flush with water.

Section III. MATERIALS - Continued

(1) SMR CODE	(2) NATIONAL STOCK NUMBER	(3) DESCRIPTION	(4) UNIT OF ISSUE
		SLACKS, WOMEN: CLASSIC DESIGN, POLYESTER/WOOL	
PAFZZ	8305-01-003-6403	Cloth, Polyester/Wool Serge, Army Green 344, 11.3 oz., MIL-C-823, Type II, Class 3	YD
PAFZZ		Thread, Cotton-covered Polyester, MIL-T-43548 Green E, C.A. 66034; Size 50, 3 Ply; Size 70, 2 Ply	TU
PAFZZ		Fastener, Slide, Plastic, Polyester or nylon continuous element chain with an automatic lock slider, top stop, staple-bottom stop, 7/16 or 9/16 inch width tape, V-F-106, Type I, Style 3, Size LS, Green C.A. 66524	EA
PAFZZ	8315-00-240-3562	Hook and Eye, Dressmaker, No. 3, (03961), Nickel Plate Finish	EA
		SKIRT, WOMAN'S, CLASSIC DESIGN, POLYESTER/WOOL	
PAFZZ	8305-01-003-6403	Cloth, Polyester/Wool Serge, Army Green 344, 11.3 oz., MIL-C-823, Type III, Class 3	YD
PAFZZ	Thread, Cotton-covered	Polyester, MIL-T-43548 Green E, C.A. 66034; Size 50, 3 Ply; Size 70, 2 Ply	TU
PAFZZ	8305-01-003-6403	Cloth, Polyester/Wool Serge, Army Green 344, 11.3 oz., MIL-C-823, Type III, Class 3	YD
PAFZZ		Thread, Cotton-covered Polyester, MIL-T-43548 Green E, C.A. 66034; Size 50, 3 Ply; Size 70, 2 Ply	TU
PAFZZ	8310-00-634-9821	Thread, Gimp, Cotton, V-T-280, Type I, Size 8, Green E, C.A. 66034	SL
PAFZZ		Button, Sewing Hole, V-T-871, Type II, Class D, Style 20 or 21, Size 24 Line, Army Green BR, C.A. 62015	GR
PAFZZ		Fastener, Slide, Plastic, Polyester or nylon continuous element chain with an automatic lock slider, top stop, staple-bottom stop, 7/16 or 9/16 inch width ape, V-F-106, Type I, Style 3, Size LS, Green C.A. 66524	EA

Section III. MATERIALS - Continued

(1) SMR CODE	(2) NATIONAL STOCK NUMBER	(3) DESCRIPTION	(4) UNIT OF ISSUE
		COAT, WOMAN'S, CLASSIC DESIGN, POLYESTER/WOOL 11.5 OZ	
PAFZZ	8305-01-003-6403	Cloth, Polyester/Wool Serge, Army Green 344, 11.3 oz., MIL-C-823, Type III, Class 3	YD
PAFZZ	8305-01-006-4693	Cloth, Twill, Rayon, Lining, MIL-C-368, Class I Army Green 344	TU
PAFZZ	8305-00-063-2386	Cloth, Buckram, Cotton, Natural or bleached, CCC-C-438, Type I, Class II, (collar interlining)	YD
PAFZZ	8310-00-634-9821	Thread, Gimp, Cotton, V-T-280, Type I, Size 8, Green E, C.A. 66034	SL
PAFZZ		Thread, Cotton-Covered, Polyester, MIL-T-43548, Size 30, 2 or 3 ply, Green E, C.A. 66034	TU
PAFZZ		Thread, Cotton-Covered, Polyester, MIL-T-43548, Size 50, 2 or 3 ply, Green E, C.A. 66034	TU
PAFZZ		Thread, Cotton-Covered, Polyester, MIL-T43548, Size 70, 2 Ply, Green E, C.A. 66034	TU
PAFZZ		Thread, Cotton, Black Polyester, MIL-T-43548, Size 50, 2 or 3 ply	CE
PAFZZ	8310-00-451-6178	Thread, Silk, V-T-301, Size B (50), 3 Ply, C.A. 66034	TU
PAFZA	8455-00-899-0025	Buttons, Insignia, MIL-B-3461, Type I, Style II, Class A, 30 Line Hopper Back	EA
PAFZA	8455-00-899-0025	Buttons, Insignia, MIL-B-3461, Type I, Style II, Class A, 25 Line Hopper Back	EA

CHAPTER 19

MAINTENANCE OF WOMAN'S SERVICE SHIRTS

Section I. INTRODUCTION

19-1. SCOPE

This chapter provides instructions that cover the materials, methods, and procedures for the repair and maintenance of Woman's, Polyester/Cotton, Broadcloth, Bleached white shirt. Necktab, Woman's, shirt Polyester/Cotton, durable press, plain weave (poplin) cloth. Shirt Woman's, Short and Long Sleeve, Polyester/Cotton Army Green 415, Durable Press.

19-2. COMMODITY SPECIFICATION

a. Items

SPECIFICATION	ITEM
MIL-S-43505C(GL)	Shirt, Woman's, Short Sleeve, Polyester/Cotton Broadcloth, Bleached White, conforming to Type I, class IV
MIL-N-44106(GL)	Necktab Woman's, Shirt
M IL-S-44090(GL)	Shirt, Woman's, Short Sleeve, Polyester/Cotton, Army Green 415, (Durable Press)
MIL-S-44093(GL)	Shirt, Woman's, Long Sleeve, Polyester/Cotton, Army Green 415, (Durable Press)

b. Components.

SPECIFICATION	ITEM
V-B-871	Button Sewing Hole, and Button, Staple, (Plastic)
V-T-276	Thread, Cotton
MIL-C-43479	Cloth, Broadcloth, Polyester/Cotton
MIL-T-43548	Thread, Polyester, Cotton-Covered
MIL-C-43843	Cloth, Plain Weave, Polyester/Cotton, Precured, (Durable Press)
MIL-C-43836	Cloth, Interlining, Non-Woven
M IL-C-43594	Cloth Interlining, Polyester
M I L-T-43624	Thread, Polyester, Spun
MIL-C-43992	Cloth, Broadcloth, Polyester/Cotton (Durable Press)
MIL-P-55010	Plastic Sheet, Polyethylene Terephthalate

19-3. TECHNICAL PUBLICATIONS

NUMBER	TITLE
FM 10-280	Field Laundry, Bath and Clothing Exchange Operations

19-4. IDENTIFICATION AND DESCRIPTION |

- a. Shirt Woman's, Short Sleeve, Polyester/Cotton Broadcloth, Bleached White, Conforming to Type I Class IV The shirts are fabricated from polyester/cotton Broadcloth Bleached White, conforming to Type I Class IV of MIL-C-43479 The shirt is hip length, short sleeve, semi-fitted, with one piece back-to-front yoke and a collar with rounded ends and collar tabs. (See figure 19-1 and table 19-1)
- b. Necktab, Woman's, shirt polyester/cotton, durable press, plain weave (poplin) cloth.

SCHEDULE SIZES

Type 1 - Necktab for Short Sleeve Shirt

4-12 (8445-01-118-8177)	14-20 (8445-01-118-8178)
-----------------------------	-----------------------------

Type II - Necktab for Long Sleeve Shirt

one size
14-20
(8445-01-118-8176)

The necktab fastens (to pile fastener tape) underneath the collar of the Woman's, AG-415 Shirt. Type I comes in two sizes (4-12; 14-20) and fastens to the front of the short sleeve shirt at the neck. Type II comes in one size only and fastens to the stand of the long sleeve shirt collar. The necktabs are the tab configuration overlapping and attached to a narrow Neckband with tabs forming angles. (See figure 19-2)

- c. Shirt Woman's, Short Sleeve, Polyester/Cotton Army Green 415, Durable Press. The shirts are fabricated from polyester/cotton broadcloth, Army Green 415, conforming to MIL-C-43992. The shirt is a semi-fitted hip length overblouse style with a short sleeve, shoulder loop, convertible collar, 6 Button cut away front, side body, and darts at waist, bust and back neck. Each shirt has a black detachable neck band and tab that fastens to the front underneath the collar. The necktab comes in two sizes, one for the shirt sizes 6-12 and one for sizes 14-20. (See figure 19-3 and table 19-2.)

19-4. IDENTIFICATION AND DESCRIPTION-Continued

- d. Shirt Woman's, Long Sleeve, Polyester/Cotton Army Green 415, Durable Press The shirts are fabricated from Polyester/Cotton Broadcloth, Army Green 415, conforming to MIL-C-43992. The shirt is semi-fitted hip length overblouse style with long sleeve, shoulder loop, collarstand, 6 button cut away front, side body, and darts at waist, bust and back neck, each shirt has a black detachable neck band and tab that fastens to the collarstand (See figure 19-4 and tables 19-3 and 19-4)

19-4. IDENTIFICATION AND DESCRIPTION-Continued

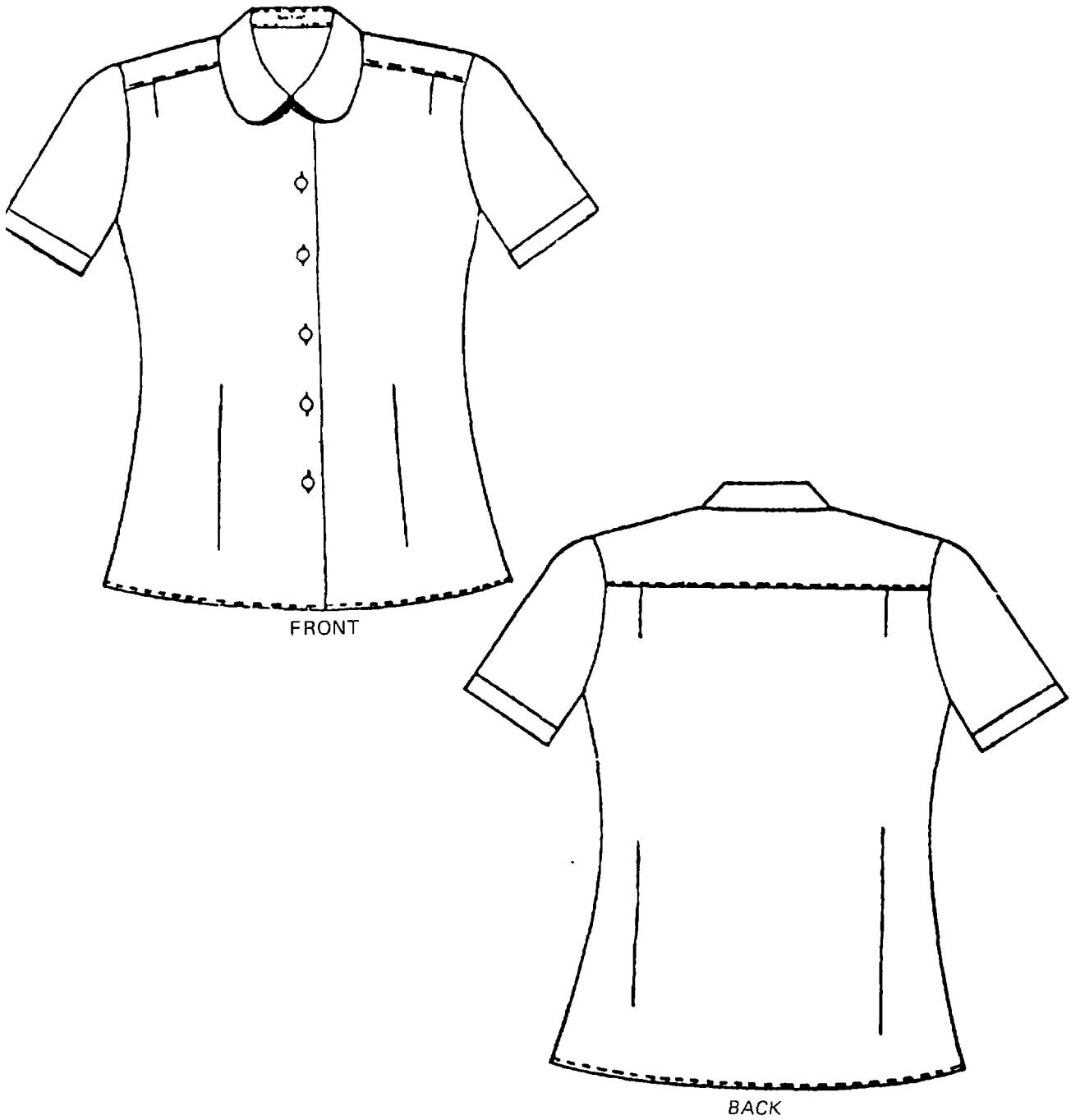

Figure 19-1. Women's Polyester/Cotton Shirt, Bleached White.

19-4. IDENTIFICATION AND DESCRIPTION-Continued

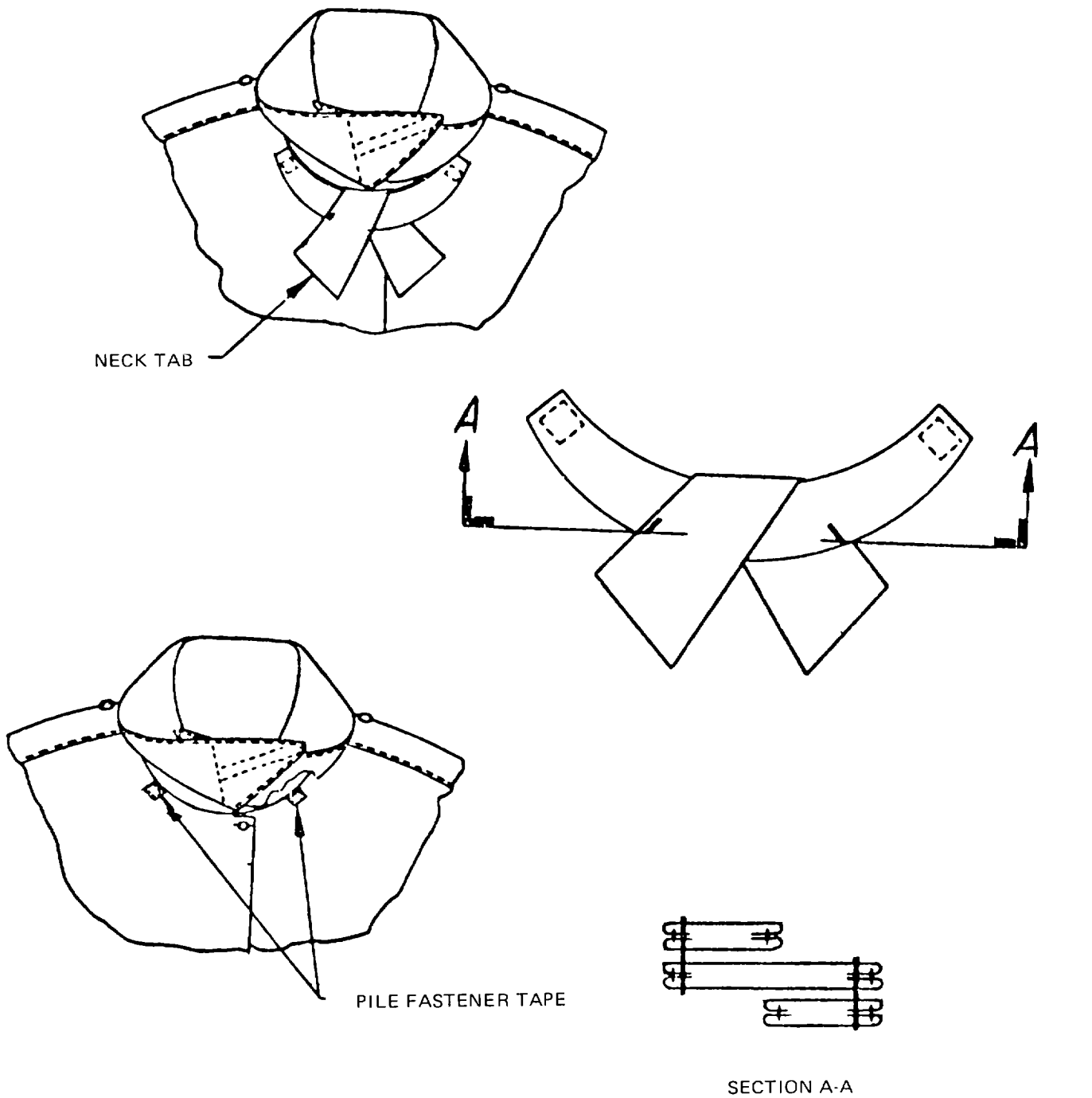

Figure 19-2. Neck Tab and Band for Women's Shirts, Short Sleeve or Long Sleeve

19-4. IDENTIFICATION AND DESCRIPTION-Continued

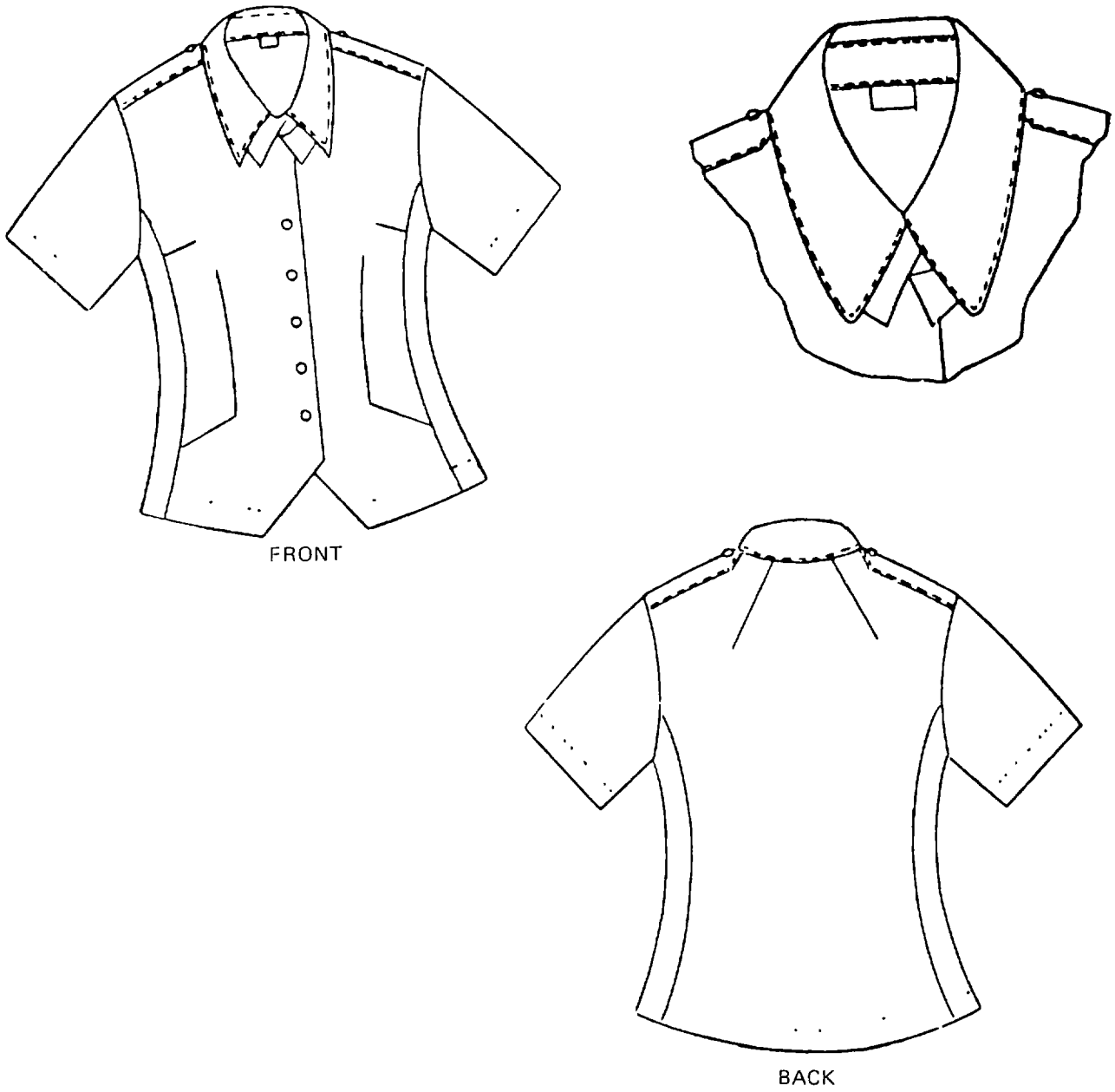

Figure 19-3. Women's Short Sleeve Shirt, Army Green 415.

19-4. IDENTIFICATION AND DESCRIPTION-Continued

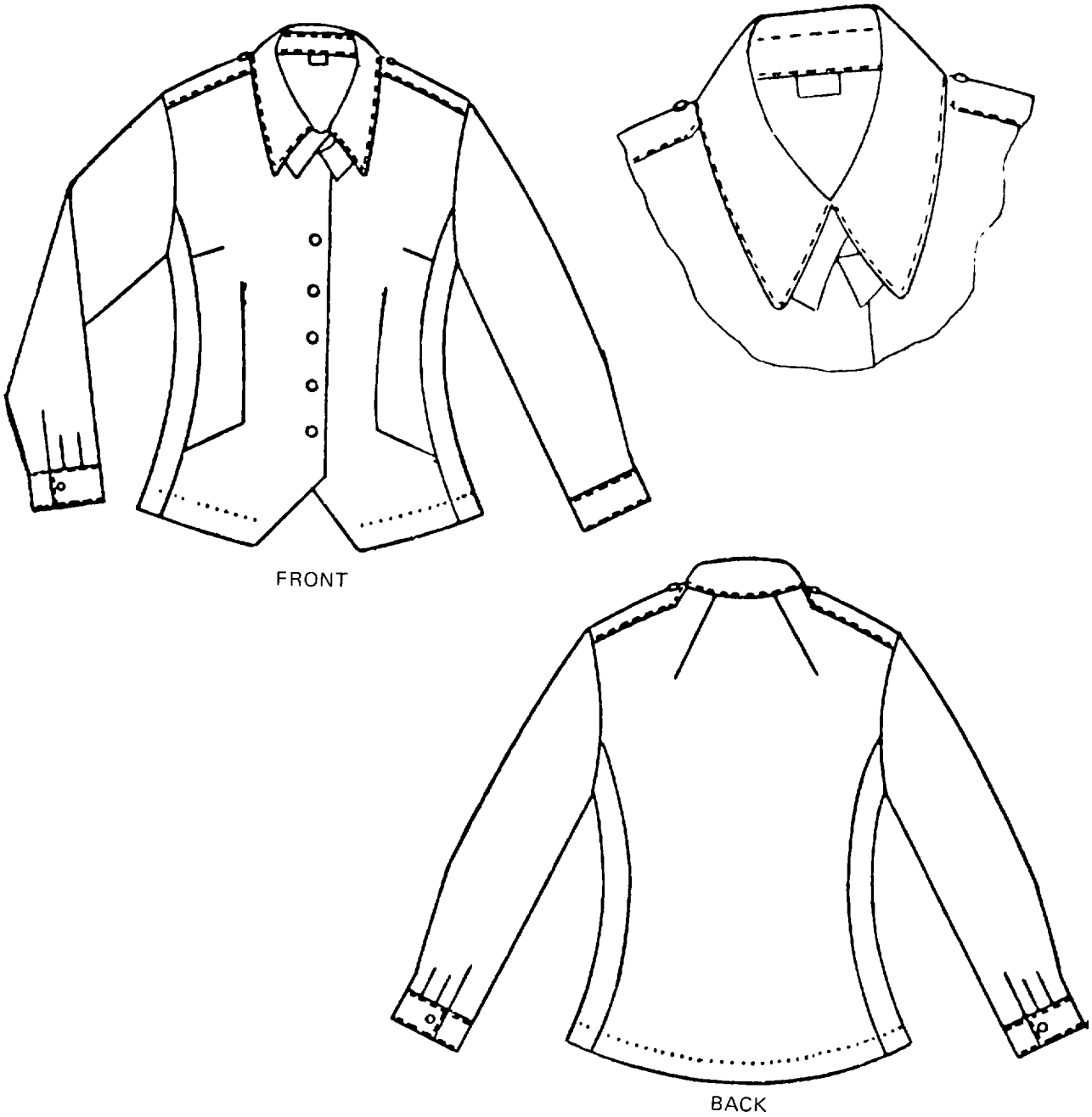

Figure 19-4. Women's Long Sleeve Shirt, Army Green 415

19-4. IDENTIFICATION AND DESCRIPTION-Continued**Table 19-1. Women's Bleached White Short-Sleeve Shirt: Schedule of sizes**

NSN	SIZE (Regular)	1/2 BUST	CROSS BACK	BACK LENGTH
8410-00-107-8231	6 R	18-1/8	14-5/8	24-1/4
8410-00-107-8234	8 R	18-7/8	15	24-1/2
8410-00-107-8242	10 R	19-5/8	15-1/4	24-3/4
8410-00-107-8244	12 R	20-1/4	15-3/8	25
8410-00-107-8253	14 R	21	15-5/8	25-1/4
8410-00-107-8256	16 R	21-3/4	16	25-1/2
8410-00-107-8257	18 R	22-3/4	16-1/2	25-3/4
8410-00-107-8228	20 R	23-3/4	17	26

Table 19-2. Women's Army Green Short-Sleeve Shirt. Schedule of sizes

NSN	SHORT	1/2 BUST	CROSS BACK	1/2 SWEEP	SLEEVE LENGTH	BACK LENGTH
8410-01-147-2077	2 S	17	13-3/4	17-1/2	8	19-3/4
8410-01-147-2080	4 S	17-1/2	14	18	8-1/8	22
8410-01-147-2076	20 S	23-1/4	16-7/8	23-3/4	9-1/8	22
8410-01-104-6496	6 S	18	14-1/4	18-1/2	8-1/4	20-3/8
8410-01-104-6499	8 S	18-1/2	14-1/2	19	8-3/8	20-5/8
8410-01-104-6502	10 S	19	14-3/4	19-1/2	8-1/2	20-7/8
8410-01-104-6505	12 S	19-3/4	15-1/8	20-1/4	8-5/8	21-1/8
8410-01-104-6508	14 S	20-1/2	15-1/2	21	8-3/4	21-3/8
8410-01-104-6511	16 S	21-1/4	15-7/8	21-3/4	8-7/8	21-5/8
8410-01-104-6514	18S	22-1/4	16-3/8	22-3/4	9	21-7/8
	REGULAR					
8410-01-147-2078	2 R	17	13-3/4	17-1/2	8-3/8	21
8410-01-104-6490	4 R	17-1/2	14	18	8-1/2	21-3/8
8410-01-104-6497	6 R	18	14-1/4	18-1/2	8-5/8	21-5/8
8410-01-104-6500	8 R	18-1/2	14-1/2	19	8-3/4	21-7/8
8410-01-104-6503	10 R	19	14-3/4	19-1/2	8-7/8	22-1/8
8410-01-104-6506	12 R	19-3/4	15-1/8	20-1/4	9	22-3/8
8410-01-104-6509	14 R	20-1/2	15-1/2	21	9-1/8	22-5/8
8410-01-104-6512	16 R	21-1/4	15-7/8	21-3/4	9-1/4	22-7/8
8410-01-104-6515	18 R	22-1/4	16-3/8	22-3/4	9-3/8	23-1/8
8410-01-104-6517	20 R	23-1/4	16-7/8	23-3/4	9-1/2	23-3/8

19-4. IDENTIFICATION AND DESCRIPTION-Continued

NSN	LONG	1/2 BUST	CROSS BACK	1/2 SWEEP	SLEEVE LENGTH	BACK LENGTH
8410-01-147-2079	2 L	17	13-3/4	17-1/2	8-7/8	22-1/4
8410-01-104-6491	4 L	17-1/2	14	18	9	22-5/8
8410-01-104-6498	6 L	18	14-1/4	18-1/2	9-1/8	22-7/8
8410-01-104-6501	8 L	18-1/2	14-1/2	19	9-1/4	23-1/8
8410-01-104-6504	10 L	19	14-3/4	19-1/2	9-3/8	23-3/8
8410-01-104-6507	12 L	19-3/4	15-1/8	20-1/4	9-1/2	23-5/8
8410-01-104-6510	14 L	20-1/2	15-1/2	21	9-5/8	23-7/8
8410-01-104-6513	16 L	21-1/4	15-7/8	21-3/4	9-3/4	24-1/8
8410-01-104-6516	18 L	22-1/4	16-3/8	22-3/4	9-7/8	24-3/8
8410-01-104-6518	20 L	23-1/4	16-7/8	23-3/4	10	24-5/8
EXTRA LARGE						
8410-01-104-6492	8	18-1/2	14-1/2	19	9-3/4	24-3/8
8410-01-104-6493	10	19	14-3/4	19-1/2	9-7/8	24-5/8
8410-01-104-6494	12	19-3/4	15-1/8	20-1/4	10	24-7/8
8410-01-104-6495	14	20-1/2	15-1/2	21	10-1/8	25-1/8

19-4. IDENTIFICATION AND DESCRIPTION-Continued

Table 19-3. Women's Army Green Long-Sleeve Shirt Schedule of Sizes

NSN	SHORT	SLEEVE LENGTH
8410-01-105-2495 & 7950	6	20-7/8 & 22-1/8
8410-01-104-7951 & 7952	8	21-1/8 & 22-3/8
8410-01-104-7954 & 7955	10	21-3/8 & 22-5/8
8410-01-104-7958 & 7959	12	21-5/8 & 22-7/8
8410-01-104-7962 & 105-2518	14	21-7/8 & 23-3/8
8410-01-104-4713 & 2497	16	22-1/8 & 23-3/8
8410-01-105-2498 & 2499	18	22-3/8 & 23-5/8
	REGULAR	
8410-01-105-2501 & 7947	4	22 & 23-1/4
8410-01-105-2502 & 2503	6	22-1/4 & 23-1/2
8410-01-105-2506 & 2507	8	22-1/2 & 23-3/4
8410-01-105-2510 & 2511	10	22-3/4 & 24
8410-01-105-2514 & 2515	12	23 & 24-1/2
8410-01-105-2519 & 2520	14	23-1/4 & 24-1/2
8410-01-105-2524 & 2525	16	23-1/2 & 24-3/4
8410-01-105-2528 & 2529	18	23 3/4 & 25
8410-01-105-2532 & 2533	20	24 & 25-1/4
	LONG	
8410-01-104-7948 & 7949	4	23-1/2 & 24-3/4
8410-01-105-2504 & 2505	6	23-3/4 & 25
8410-01-105-2508 & 2509	8	24 & 25-1/4
8410-01-105-2512 & 2513	10	24-1/4 & 25-1/2
8410-01-105-2516 & 2517	12	24-1/2 & 25-3/4
8410-01-105-2521 & 2522	14	24-3/4 & 26
8410-01-105-2526 & 2527	16	25 & 26-1/4
8410-01-105-2530 & 2531	18	25-1/4 & 26-1/2
8410-01-105-2534 & 2500	20	25-1/2 & 26-3/4
	EXTRA LONG	
8410-01-104-7953 & 2494	8	25-1/2 & 26-1/2
8410-01-104-7956 & 7957	10	25-3/4 & 26-3/4
8410-01-104-7960 & 7961	12	26 & 27
8410-01-104-2496 & 2523	14	26-1/4 & 27-1/4

Section II. REPAIR PROCEDURES

19-5. MATERIALS

Materials used in the repair of the shirts shall be serviceable materials recovered from similar salvaged items, when authorized, or will be new materials as specified in Section III. New materials will be requisitioned from stock under the stock numbers and for item description and shall conform to the appropriate specifications. When not available from stock, materials may be purchased locally which conform as closely as possible to the standard material.

19-6. REPAIR AND MAINTENANCE

Prior to repair operations, each item shall be inspected by qualified personnel to determine the amount of repair necessary. Repair will be made as fully as skills, facilities, funds and local conditions permit. The sequence of operations shall be determined by the repairing organization, unless otherwise prescribed.

- a. Inspection. Inspect all items to determine the amount of repairs needed and whether such repairs can be accomplished within the organization, or evacuate to direct support level of maintenance.
- b. Cleaning. User will keep garments clean, either by individual laundering in water by hand or machine washing with mild soap or detergent or by use of installation laundry facilities.
- c. Organizational Repair. Repair to be accomplished within the organization will be hand sewing of rips, tears, loose seams, damaged buttonholes. Replace missing or damaged buttons. Replacement buttons will match the original buttons in color, design, and size of the type specified in Section III.
- d. Direct Support Maintenance.
 - (1) Preliminary examination and cleaning. Dirt, mud, dust, spots, stains, and other foreign matter will be removed with a brush or by laundering. Rotten items will be discarded. Seams will be tested by grasping the items with both hands and pulling at right angles to the seams. Areas to be repaired shall be marked with crayon. Non-specification and personal marks shall be erased or obliterated.
 - (2) Laundry. Shirts shall be processed in laundry facilities in accordance with established practices set forth in FM 10-280. When such facilities are not available, items shall be laundered by contract with private industry in accordance with accepted commercial laundry practices.

19-6. REPAIR AND MAINTENANCE-Continued

(3) Repair

(a) Stitching and restitching. Use machine sewing wherever possible for all stitching and restitching of Items. Backstitch or bartack all stitching at ends to prevent raveling. Maintain proper thread tension to prevent loose stitching and to imbed the lock in the center of the material sewn. Overlock all thread breaks In overedge stitching not less than 3/4 Inch (1.91 cm) at each break. Restitch seams containing loose and/or broken threads. Overstitch thread breaks In type 301 stitching not less than (1/2 Inch (1.27 cm) at each break. When type 401 stitch is used, place looper thread on the underside For illustration of the various types of stitches used, see FED. STD NO 751. Thread shall conform to MIL-T-43548 and the type, thread size and stitches per Inch required for the repair shall be as follows.

USE	STITCH TYPE	THREAD		STITCH PER INCH
		NEEDLE	BOBBIN	
General	301	70/3	70/3	10-14
General	401	70/3	70/3	10-14
Overedge	502 or 503	70/3	70/3	6-10
Bartacks	-	70/3	70/3	28 per bartack
Buttonholes	304	70/3	70/3	42-52 per buttonholes
Buttons	101 or	70/3	70/3	14-16 per button
301	70/3	70/3	14-16 per button	

(b) Patching and darning. Repair rips, tears and holes that will not be visible when garment is worn. Repair rips, tears and holes in areas 1/2 inch (1.27 cm) or less in greatest dimension Repair rips, tears, and holes greater than 1/2 Inch (1.27 cm) but not exceeding 1 Inch (2.54 cm) Cut the patch of sufficient size to extend at least 1/4 to 3/8 inches (0.635 to 0.953 cm) beyond the hole or area to be patched, allowed for a 1/4 inch (0.635 cm) turn under. Place the patch on the outside and sew it 1/16 to 1/8 inches (0.159 to 0.318 cm) from the edge of the patch. Cut away damaged area to a square or rectangular shape, depending upon the shape of the hole, turn the raw edges under 1/4 Inch (0.635 cm) and sew 1/16 to 1/8 inches (0 159 to 0.318 cm) from the edge.

(c) Button. Replace missing, broken, or damaged buttons using Item listed in Section III

19-6. REPAIR AND MAINTENANCE - Continued

- (d) Buttonholes. Reshape enlarged buttonholes by securely tacking the ends for proper fit over corresponding buttons. Rework damaged buttonholes by stitching a small reinforcement patch to the underside of the shirt and reworking through the patch. Buttonholes shall be of the straight-cut, purl or whip type and the finished cut length shall be according to original construction.
- (e) Pocket and flaps. Repair or replace torn, missing or defective pockets and flaps. Restitch ripped seams, loose or missing stitching on flaps and pockets. Darn small holes, cuts and tears and patch slightly larger holes. The darning and patching shall not be visible when the pocket flap is buttoned.
- (f) Shoulder loops. Restitch loose or missing stitching, and replace missing or defective shoulder loop. When the outer face of a shoulder loop shows unacceptable defects, reverse and place on opposite shoulder, provided shade of fabric matches. When replacement is necessary, fabricate shoulder loops as original construction from conforming cloth.
- (g) Hems. Turn under all frayed hems and stitch 1/16 to 1/8 inch (0.159 to 0.318 cm) from edge.

19-7. WORKMANSHIP

All work shall be accomplished by personnel skilled in the particular trade applicable to their duties in the repair of subject items. Darning shall be neatly accomplished and patches shall be of the proper size and firmly stitched to the garments. Stitching and reseaming shall be secure, and loose ends shall be trimmed and removed. Buttons shall be securely and properly attached to function as intended. The finished items shall be completely and well repaired, thoroughly cleaned, and free from all defects which may effect serviceability or general appearance.

19-8. INSPECTION

The inspection or quality control unit is responsible for determining compliance with repair instruction and requirement for classification. In process inspections will be performed for quality of workmanship and correct application of repair procedure. The completed items will be inspected for serviceable appearance and condition, to insure against return of a substandard product to supply channels.

Section III. MATERIALS - Continued

(1) SMR CODE	(2) NATIONAL STOCK NUMBER	(3) DESCRIPTION	(4) UNIT OF ISSUE
		SHIRT, WOMAN'S, POLYESTER/COTTON	
XBFZZ		Cloth, Polyester/Cotton Broadcloth, bleached white, MIL-C-43479, Type I, Class I	YD
PAFZZ		Thread, Cotton-covered Polyester, MIL-T-43548, White AH, C.A. 66050, Size 70, 2 Ply; Size 80, 2 Ply	TU
PAFZZ		Button, Sewing Hole, V-B-871, Type II, Class K, Style 25, Size 19 Line, Polyester White, Shade BA, C.A. 62031	GR
		NECKTAB, WOMAN'S SHIRT	
PAFZZ		Thread, Cotton-covered Polyester, MIL-T-43548 Green E, C.A. 66043; Size 70, 2 Ply; Size 80, 2 Ply	TU
PAFZZ		Fastener Tape, Hook, Nylon, MIL-F-21840, Type I, Class I, Black 3230, 5/8 inches wide	YD
		SHIRT, WOMAN'S, SHORT SLEEVE, POLYESTER/COTTON, ARMY GREEN 415, DURABLE PRESS	
PAFZZ	8305-01-074-1843	Cloth, Polyester/Cotton Broadcloth, Army Green 415, MIL-C-43992	YD
PAFZZ		Thread, Cotton- or Polyester-Covered A-A-50199, White AH, C.A. 66050: Size 70, 2 or 3 Ply Size 100, 2 or 3 Ply	TU
PAFZZ		Button, Sewing Hole, V-B-871, Type II, Class K, Style 25, Size 19 Line, Polyester White, Shade BA, C.A. 62031	GR
PAFZZ		Fastener Tape, Pile, Nylon, MIL-F-21840, Type I, Class I, Black 3230, 5/8 inches wide	YD

Section III. MATERIALS - Continued

(1) SMR CODE	(2) NATIONAL STOCK NUMBER	(3) DESCRIPTION	(4) UNIT OF ISSUE
PAFZZ	8305-01-074-1843	<p style="text-align: center;">SHIRT, WOMAN'S, LONG SLEEVE, POLYESTER/COTTON, ARMY GREEN 415, DURABLE PRESS</p> <p>Cloth, Polyester/Cotton Broadcloth, Army Green 415, MIL-C-43992</p>	YD
PAFZZ		<p>Thread, Cotton- or Polyester-Covered A-A-50199, White AH, C.A. 66050: Size 70, 2 or 3 Ply Size 100, 2 or 3 Ply</p>	
PAFZZ		<p>Button, Sewing Hole, V-B-871, Type II, Class K, Style 25, Size 19 Line, Polyester White, Shade BA, C.A. 62031</p>	GR
PAFZZ		<p>Fastener Tape, Pile, Nylon, MIL-F-21840, Type I, Class I, Black 3230, 5/8 inches wide</p>	YD

CHAPTER 20
MAINTENANCE OF THE EXTENDED COLD WEATHER CLOTHING SYSTEM (ECWCS)

Section I. INTRODUCTION

20-1. SCOPE

This chapter prescribes the procedures and instructions for repair of the following individual component items of the ECWCS:

- a. Parka, Extended Cold Weather, Camouflage
- b. Trousers, Extended Cold Weather, Camouflage
- c. Liner, Cold Weather Coat
- d. Liner, Cold Weather Trousers, Field
- e. Shirt, Cold Weather, Polyester Fiberpile
- f. Overall, Bib, Cold Weather, Fiberpile
- g. Drawers, Cold Weather, Polypropylene
- h. Undershirt, Cold Weather, Polypropylene
- i. Hood, Balaclava Cold Weather
- j. Ruff, Parka, Extended Cold Weather

20-2. SPECIFICATIONS AND PUBLICATIONS

- a. Items.

SPECIFICATION	ITEM
MIL-P-44188	Parka, Extended Cold Weather, Camouflage
MIL-T-44189	Trousers, Extended Cold Weather, Camouflage
MIL-L-43536	Liner, Cold Weather Coat
MIL-L-43498	Liner, Cold Weather Trousers, Field
MIL-S-44163	Shirt, Cold Weather, Polyester Fiberpile
MIL-O-44191	Overall, Bib, Cold Weather, Fiberpile
MIL-D-44165	Drawers, Cold Weather, Polypropylene
MIL-U-44164	Undershirt, Cold Weather, Polypropylene
A-A-50194	Hood, Balaclava, Cold Weather
MIL-R-44354	Ruff, Parka, Extended Cold Weather

- b. Components.

SPECIFICATION	ITEM
V-F-106	Fastener, Slide, Interlocking
A-A-50198	Thread, Gimp, Cotton, Buttonhole
A-A-50199	Thread, Polyester Core, Cotton or Polyester - Covered
JJ-W-155	Webbing, Textile (Cotton Elastic)
CCC-C-438	Cloth, Cotton, Buckram
DDD-L-20	Label: For Clothing, Equipment and Tentage (General Use)
MIL-T-2283	Tape, Textile, Nylon, Woven, White or Dyed

20-2. SPECIFICATIONS AND PUBLICATIONS - Continued

SPECIFICATION	ITEM
MIL-F-10884 MIL-F-21840 MIL-C-21852 MIL-T-43566 V-B-871 MIL-C-508 MIL-B-41826 MIL-C-43701 MIL-C-44157 MIL-C-44187	Fastener, Snap Fastener, Tapes, Hook and Pile, Synthetic Cloth, Taffeta, Nylon Tape, Textile, Cotton, General Purpose Natural or in colors. Button, Sewing, and Button, Staple, (Plastic) Cloth, Oxford, Nylon, 3 Ounce Batting, Synthetic Fibers, Polyester, (Unquilted and Quilted) Cord, Elastic, Nylon Cloth, Plain Weave, Polyester/Cotton Cloth, Laminated, Waterproof and Moisture-Vapor Permeable
MIL-W-4088 MIL-E-20652 MIL-C-43251 MIL-C-44162 MIL-C-44161 MIL-C-43824	Webbing, Textile, Woven Nylon Eyelet, Metallic, and Eyelet Washers, Metallic Cloth, Pile, Polyester Fiberpile Cloth, Plain Weave, Polyester/Cotton Cloth, Knitted Terry, Polypropylene Cloth, Synthetic Fur, Knitted

c. Publications

NUMBER	TITLE
FM 10-16 FM 10-280 FED-STD-751	General Fabric Repair Field Laundry, Bath and Clothing Exchange Operations Stitches, Seams, and Stitchings

20-3. IDENTIFICATION AND DESCRIPTION

a. Parka, Extended Cold Weather, Camouflage.

NSN	SIZES	SPECIFICATION
8415-01-228-1306	X-Small X-Short	MIL-P-44188
8415-01-228-1307	X-Small Short	MIL-P-44188
8415-01-228-1308	X-Small Regular	MIL-P-44188
8415-01-228-1309	X-Small Long	MIL-P-44188
8415-01-228-1310	Small X-Short	MIL-P-44188
8415-01-228-1311	Small Short	MIL-P-44188
8415-01-228-1312	Small Regular	MIL-P-44188
8415-01-228-1313	Small Long	MIL-P-44188
8415-01-228-1314	Medium X-Short	MIL-P-44188
8415-01-228-1315	Medium Short	MIL-P-44188
8415-01-228-1316	Medium Regular	MIL-P-44188
8415-01-228-1317	Medium Long	MIL-P-44188
8415-01-228-1318	Large Short	MIL-P-44188
8415-01-228-1319	Large Regular	MIL-P-44188
8415-01-228-1320	Large Long	MIL-P-44188
8415-01-228-1321	X-Large Regular	MIL-P-44188
8415-01-228-1322	X-Large Long	MIL-P-44188

20-3. IDENTIFICATION AND DESCRIPTION - Continued

The parka (Figure 20-1 and Figure 20-2) is made of a triple layer laminated waterproof, windproof, and moisture vapor permeable nylon material. The garment repels water but is sufficiently porous to prevent moisture buildup from perspiration. The parka has an integral hood, two breast pockets, inside map pockets that can be opened without unzipping the parka, two large lower cargo pockets and a two-way, full front slide fastener to provide full face protection, leaving only the eyes uncovered. The underarms also have a slide fastener to provide ventilation. The parka is woodland camouflaged and is fully lined with a windsirt. There are elastic drawcords with barrel locks at the waist and a nylon, woven tape drawcord with barrel locks at the hood. Nylon woven tape is also used for the neck hanger loop. Nylon hook and pile fastener tapes are located at the wrist tabs to allow for adjustment. Snap fasteners are located at the Insignia tab along the full front closure on the overlay of the slide fastener, on the windsirt and pockets. The various garment sizes with fitting guidelines are listed in Table 20-16

b. Trousers, Extended Cold Weather, Camouflage

NSN	SIZES	SPECIFICATION
8415-01-228-1336	X-Small X-Short	MIL-T-44189
8415-01-228-1337	X-Small Short	MIL-T-44189
8415-01-228-1338	X-Small Regular	MIL-T-44189
8415-01-228-1339	X-Small Long	MIL-T-44189
8415-01-228-1340	Small X-Short	MIL-T-44189
8415-01-228-1341	Small Short	MIL-T-44189
8415-01-228-1342	Small Regular	MIL-T-44189
8415-01-228-1343	Small Long	MIL-T-44189
8415-01-228-1344	Medium X-Short	MIL-1-44189
8415-01-228-1345	Medium Short	MIL-T-44189
8414-01-228-1346	Medium Regular	MIL-T-44189
8415-01-228-1347	Medium Long	MIL-T-44189
8415-01-228-1348	Large Short	MIL-T-44189
8415-01-228-1349	Large Regular	MIL-T-44189
8415-01-228-1350	Large Long	MIL-T-44189
8415-01-228-1351	X-Large Regular	MIL-T-44189
8415-01-228-1352	X-Large Long	MIL-T-44189

20-3 IDENTIFICATION AND DESCRIPTION-Continued

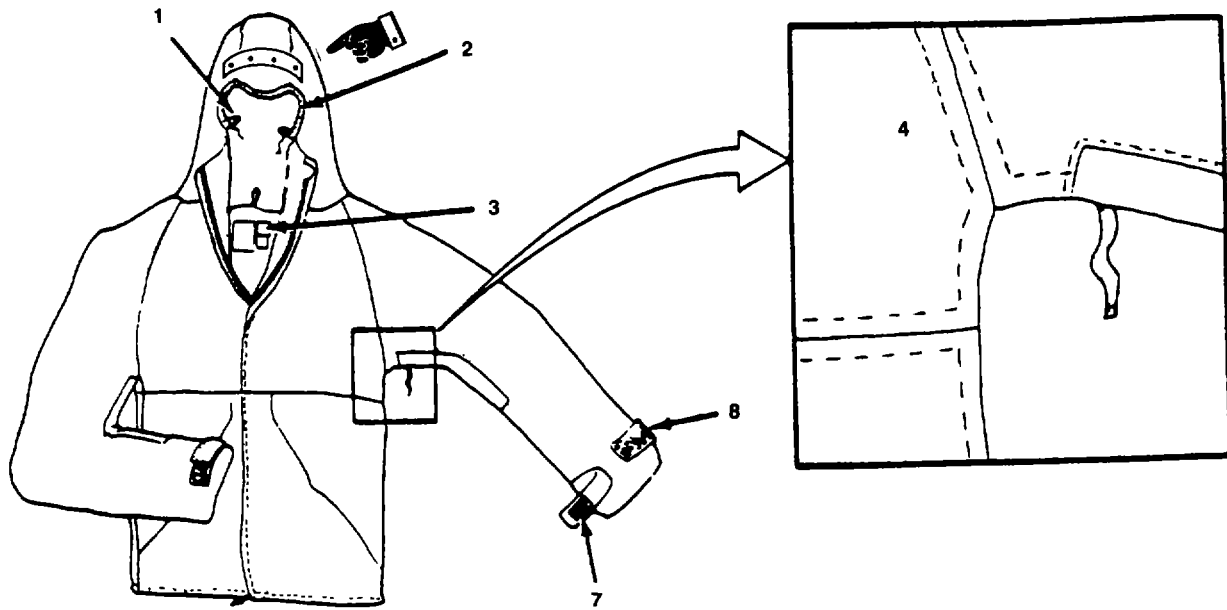

FRONT VIEW

LEGEND:

- 1 Barrel Lock
- 2 Nylon Tape
- 3 Labels
- 4 Seam Sealing Tape
(Inside Garment)
- 5 Underarm Slide Fastener
- 6 Cotton Tape
- 7 Hook Tape
- 8 Pile Tape

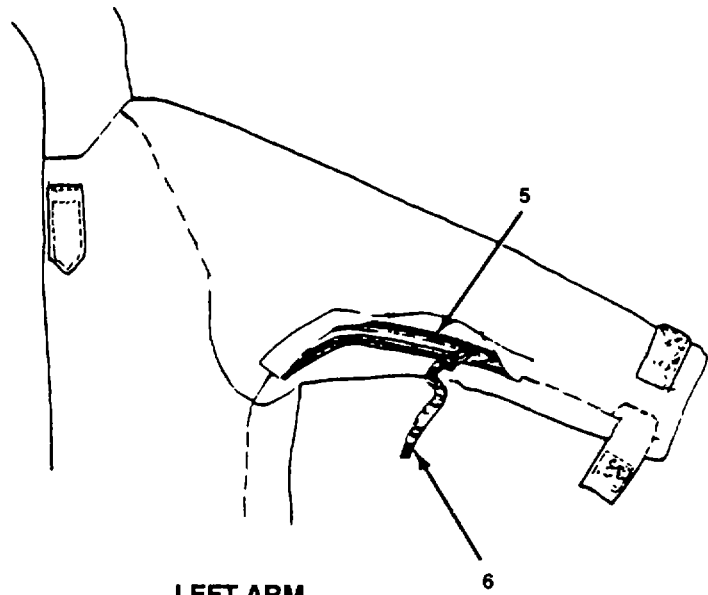

LEFT ARM

Figure 20-1. Parka, Extended Cold Weather, Camouflage

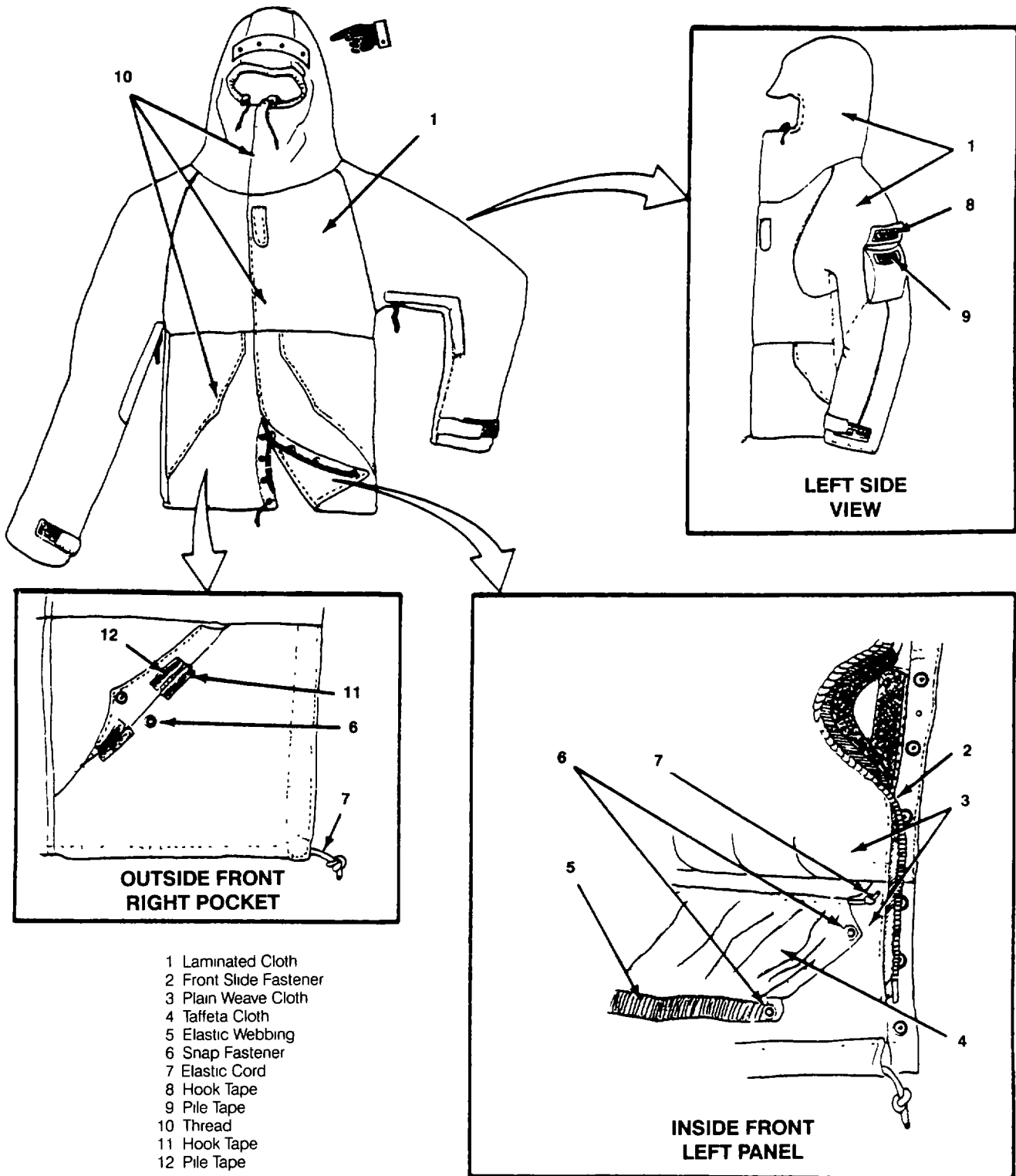

Figure 20-2. Parka, Extended Cold Weather, Camouflage

20-3. IDENTIFICATION AND DESCRIPTION - Continued

The trousers (Figure 20-3 and Figure 20-4) are made of the same material as the parka. They are also woodland camouflaged and have seat and knee patches, pass through pockets, and gusseted leg openings to allow easy donning and doffing without removing the boots. The trousers have an elastic drawcord with barrel lock at the waist. Nylon hook and pile fastener tapes are located at the ankle tabs to allow for adjustment. Slide fasteners are located on the legs and front fly. The trousers have nylon tape suspender loops. Snap fasteners are located above the front fly slide fastener and on the pockets. The various garment sizes are listed in Table 20-17.

c. Liner, Cold Weather Coat.

NSN	SIZES	SPECIFICATION
8415-01-062-0679	X-Small X-Short	MIL-L-43536
8415-00-782-2886	X-Small	MIL-L-43536
8415-01-062-0680	Small X-Short	MIL-L-43536
8415-00-782-2887	Small	MIL-L-43536
8415-01-062-0681	Medium X-Short	MIL-L-43536
8415-00-782-2888	Medium	MIL-L-43536
8415-00-782-2889	Large	MIL-L-43536
8415-00-782-2890	X-Large	MIL-L-43536

The coat liner (Figure 20-4.1) is an olive green undergarment of polyester batting covered with 3 plies of ripstop nylon cloth. The liner serves as an insulating layer for the upper body.

d. Liner, Cold Weather Trousers, Field.

NSN	SIZES	SPECIFICATION
8415-00-782-2992	X-Small Short and Regular	MIL-L-43498
8415-00-782-2993	X-Small Long	MIL-L-43498
8415-00-782-2994	Small Short and Regular	MIL-L-43498
8415-00-782-2925	Small Long	MIL-L-43498
8415-00-782-2926	Medium Short and Regular	MIL-L-43498
8415-00-782-2927	Medium Long	MIL-L-43498
8415-00-782-2928	Large Short and Regular	MIL-L-43498
8415-00-782-2929	Large Long	MIL-L-43498
8415-00-782-2930	X-Large Short and Regular	MIL-L-43498
8415-00-782-2931	X-Large Long	MIL-L-43498

The trouser liner (Figure 20-4.2) is an olive green undergarment of polyester batting covering with 3 plies of ripstop nylon cloth. The liner serves as an insulating layer for the lower body.

e. Shirt, Cold Weather, Polyester Fiberpile.

NSN	SIZES	SPECIFICATION
8415-01-228-1353	X-Small	MIL-S-441 63A
8415-01-228-1354	Small	MIL-S-441 63A
8415-01-228-1355	Medium	MIL-S-441 63A
8415-01-228-1356	Large	MIL-S-441 63A
8415-01-228-1357	X-Large	MIL-S-441 63A

The shirt (Figure 20-5) is a brown-colored, long sleeve, front opening type garment with a fold over collar that converts to a turtleneck when the front slide fastener is completely closed. A black elastic nylon drawcord with barrel lock is at the waist, with black hook and pile fastener tapes on the two chest cargo pockets, and wrist adjustments. The shoulders, underarms, sleeves, and pockets are reinforced with plain weave black polyester/cotton material. The various garment sizes are listed in Table 20-14.

20-3 IDENTIFICATION AND DESCRIPTION-Continued

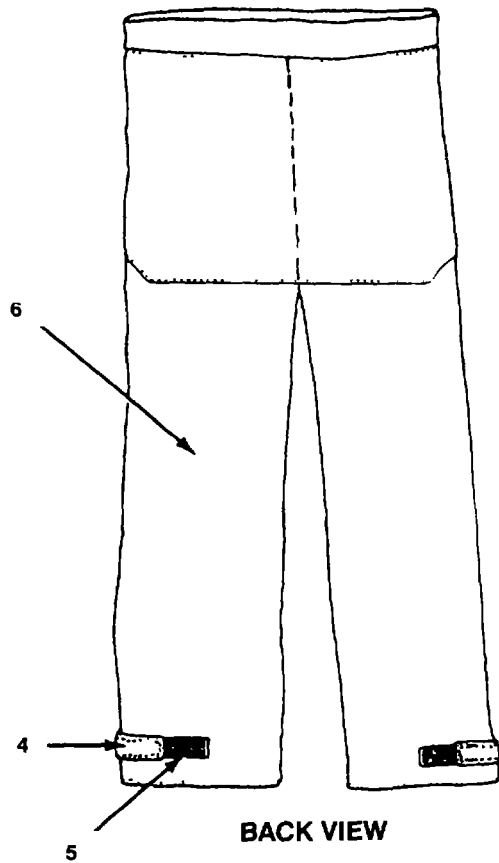

- LEGEND:**
- 1 Barrel Lock
 - 2 Elastic Cord
 - 3 Leg Slide Fastener
 - 4 Hook Tape
 - 5 Pile Tape
 - 6 Laminated Cloth

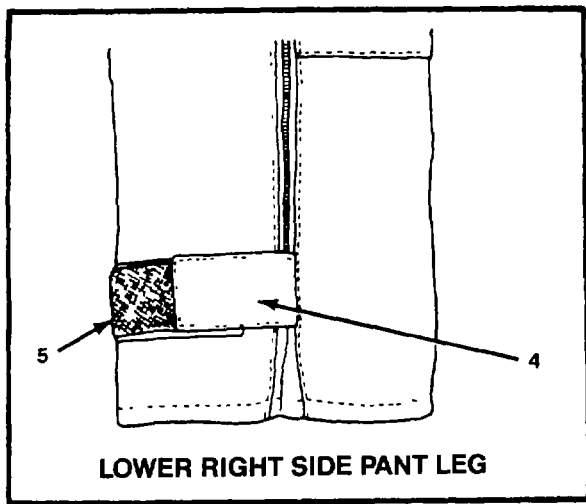
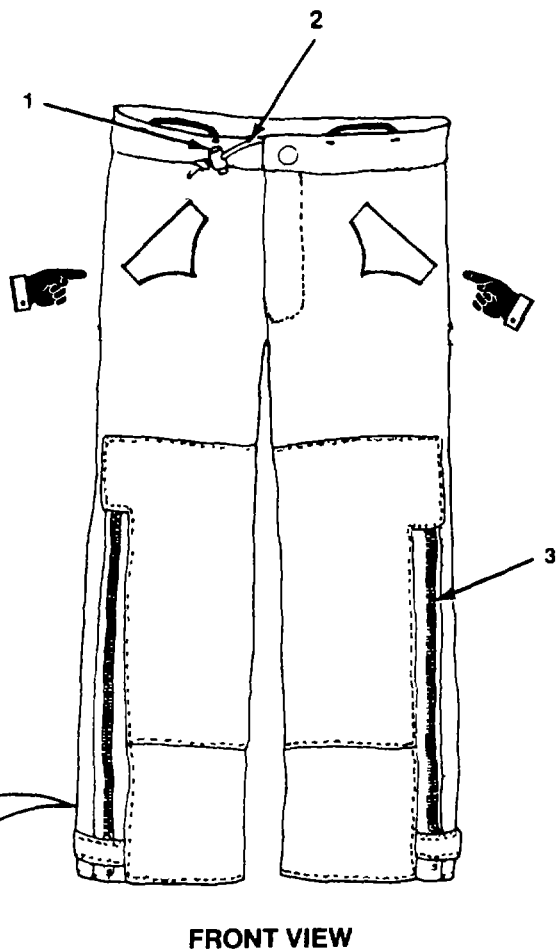

Figure 20-3. Trousers, Extended Cold Weather, Camouflage

20-3 IDENTIFICATION AND DESCRIPTION-Continued

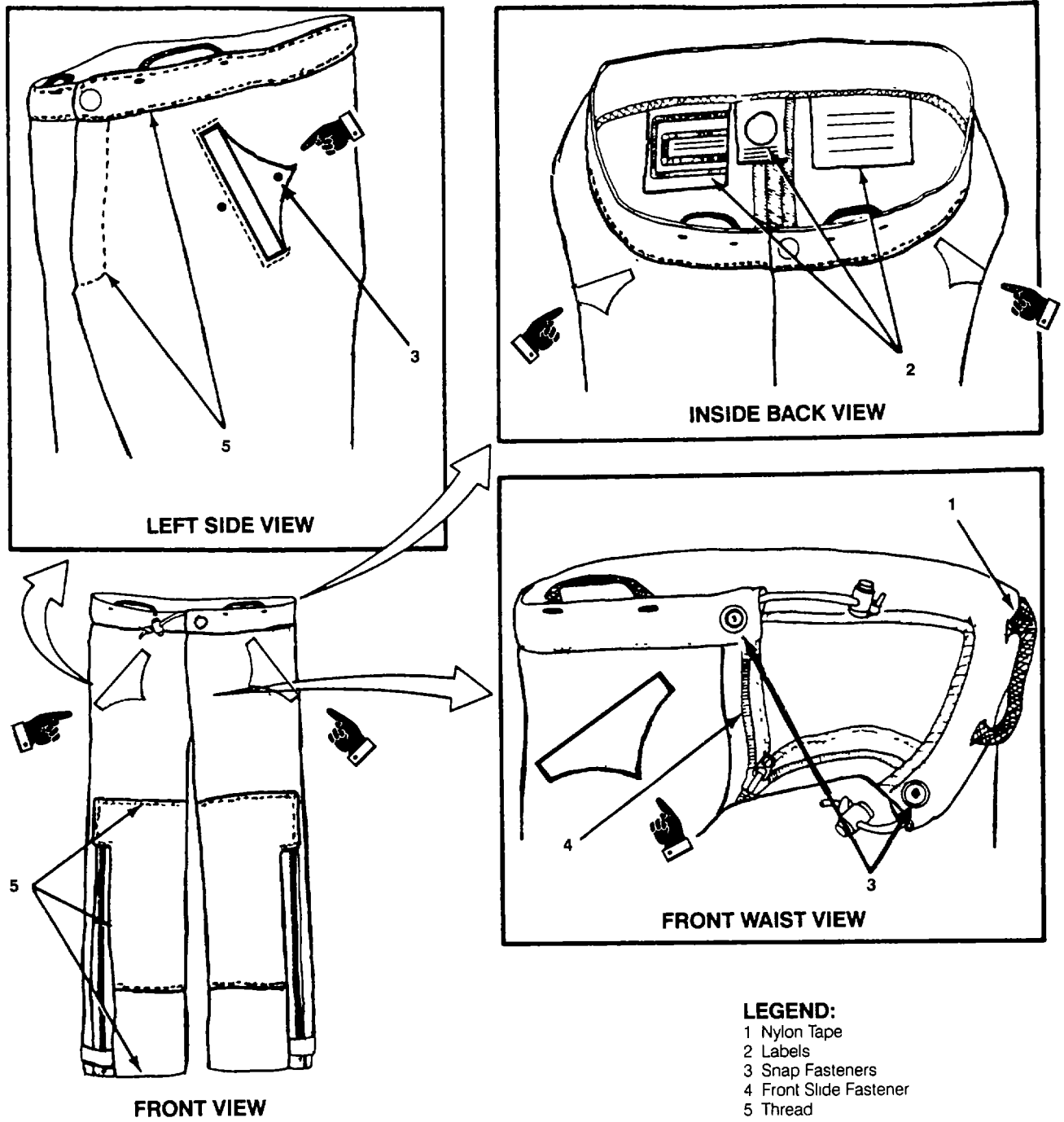
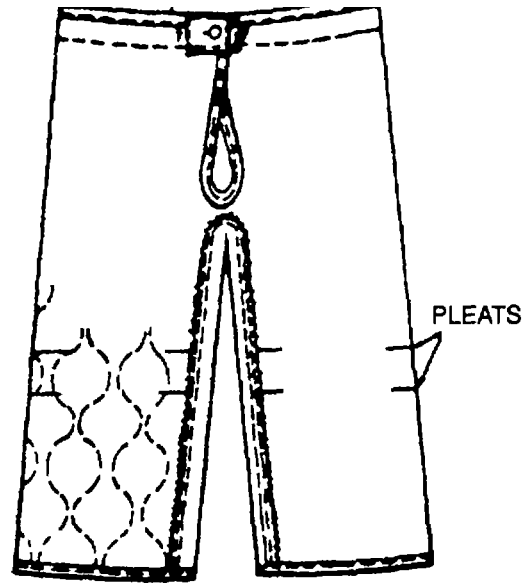

Figure 20-4. Trousers, Extended Cold Weather, Camouflage

20-3. IDENTIFICATION AND DESCRIPTION - Continued



LEGEND:

- 1. Quilted Polyester Batting
- 2. Oxford Nylon Cloth
- 3. Thread
- 4. Button
- 5. Tape

FIELD TROUSER LINER

Figure 20-4.1. Liner, Cold Weather Coat

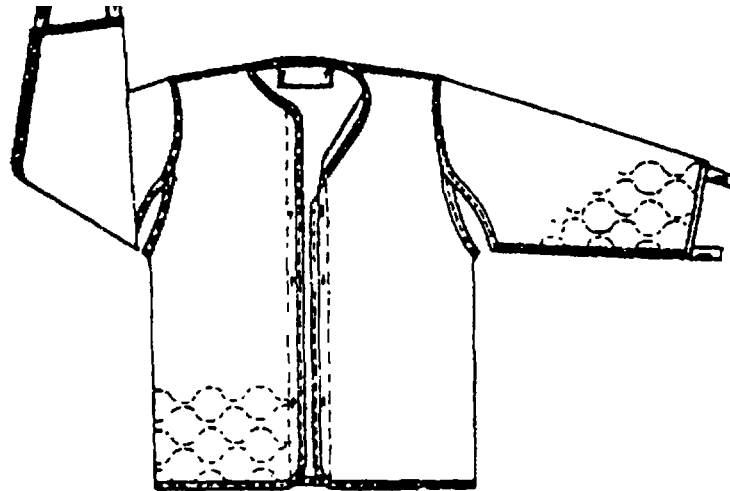

LEGEND:

- 1. Quilted Polyester Batting
- 2. Oxford Nylon Cloth
- 3. Thread
- 4. Button
- 5. Tape

COAT LINER

Figure 20-4.2. Liner, Cold Weather Trousers, Field

20-3 IDENTIFICATION AND DESCRIPTION - Continued

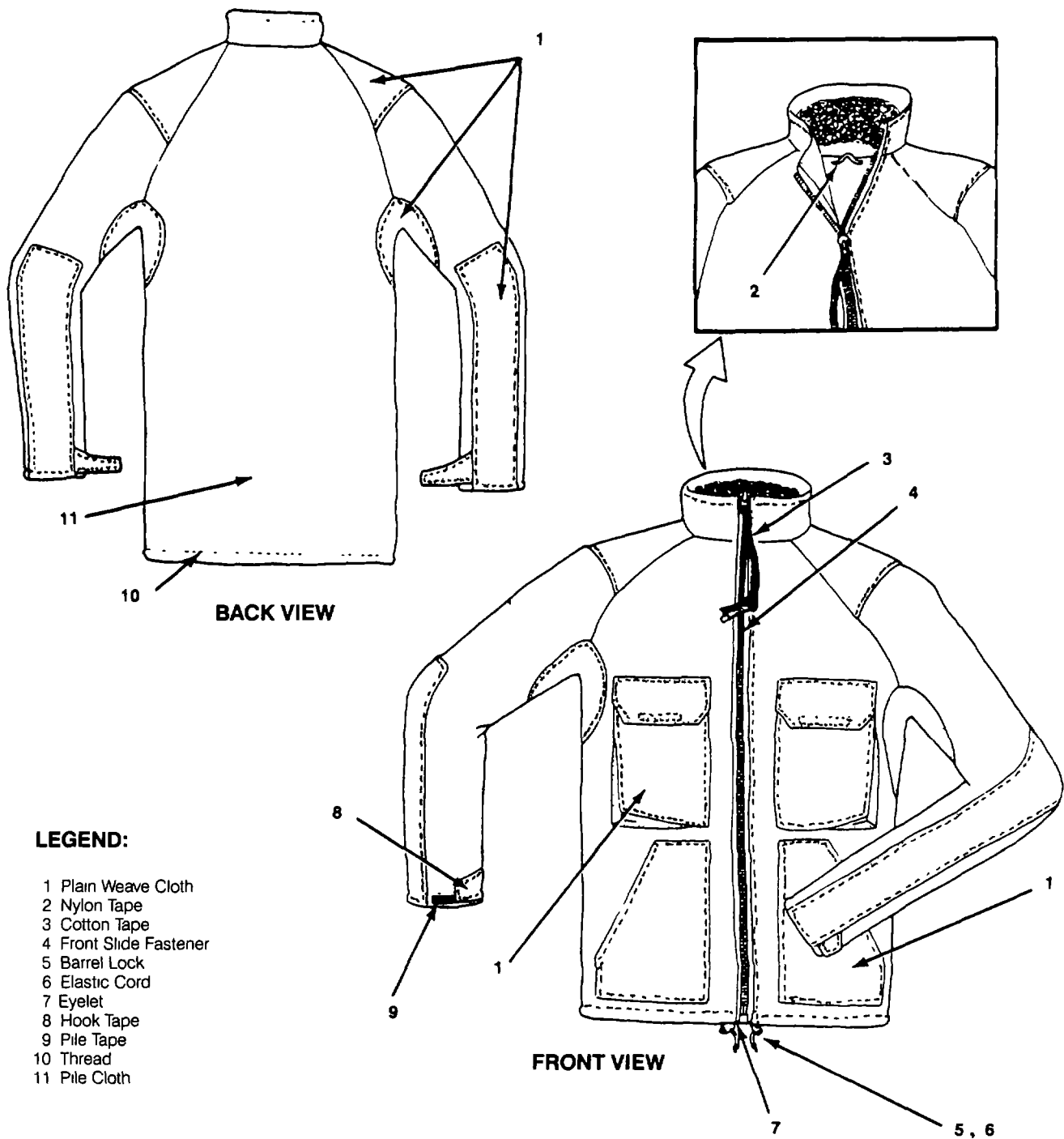

Figure 20-5. Shirt, Cold Weather, Polyester Fiberpile

20-3. IDENTIFICATION AND DESCRIPTION - Continued

f. Overall, Bib, Cold Weather, Fiberpile.

NSN	SIZES	SPECIFICATION
8415-01-228-1323	X-Small Short/Regular	MIL-0-44191
8415-01-228-1324	X-Small Long	MIL-0-44191
8415-01-228-1325	Small Short/Regular	MIL-0-44191
8415-01-228-1326	Small Long	MIL-0-44191
8415-01-228-1327	Medium Short/Regular	MIL-0-44191
8415-01-228-1328	Medium Long	MIL-0-44191
8415-01-228-1329	Large Short/Regular	MIL-0-44191
8415-01-228-1330	Large Long	MIL-0-44191
8415-01-228-1331	X-Large Short/Regular	MIL-0-44191
84154-01-228-1332	X-Large Long	MIL-0-44191

The overall (Figure 20-6) is constructed of a brown colored, knitted polyester fiberpile material and features adjustable elastic suspenders with Quick release buckles, a side full length black slide fastener and a fly slide fastener enable two-way openings. Black colored hanger loops at the back of the bib, and black colored suspender fastener loops are attached to the waistband. The various garment sizes are listed in Table 20-19

g. Drawers, Cold Weather, Polypropylene.

NSN	SIZES	SPECIFICATION
8415-01-227-9542	X-Small	MIL-D-44165
8415-01-227-9543	Small	MIL-D-44165
8415-01-227-9544	Medium	MIL-D-44165
8415-01-227-9545	Large	MIL-D-44165
84154-1-227-9546	X-Large	MIL-D-44165

The drawers (Figure 20-7) are constructed of a brown-colored knitted, brushed polypropylene material with an elastic waistband and knitted ankle cuffs. The various garment sizes are listed in Table 20-21

h. Undershirt, Cold Weather, Polypropylene

NSN	SIZES	SPECIFICATION
8415-01-227-9547	X-Small	MIL-U-44164
8415-01-227-9448	Small	MIL-U-44164
8415-01-227-9549	Medium	MIL-U-44164
8415-01-227-9550	Large	MIL-U-44164
8415-01-227-9551	X-Large	MIL-U-44164

20-3. IDENTIFICATION AND DESCRIPTION - Continued

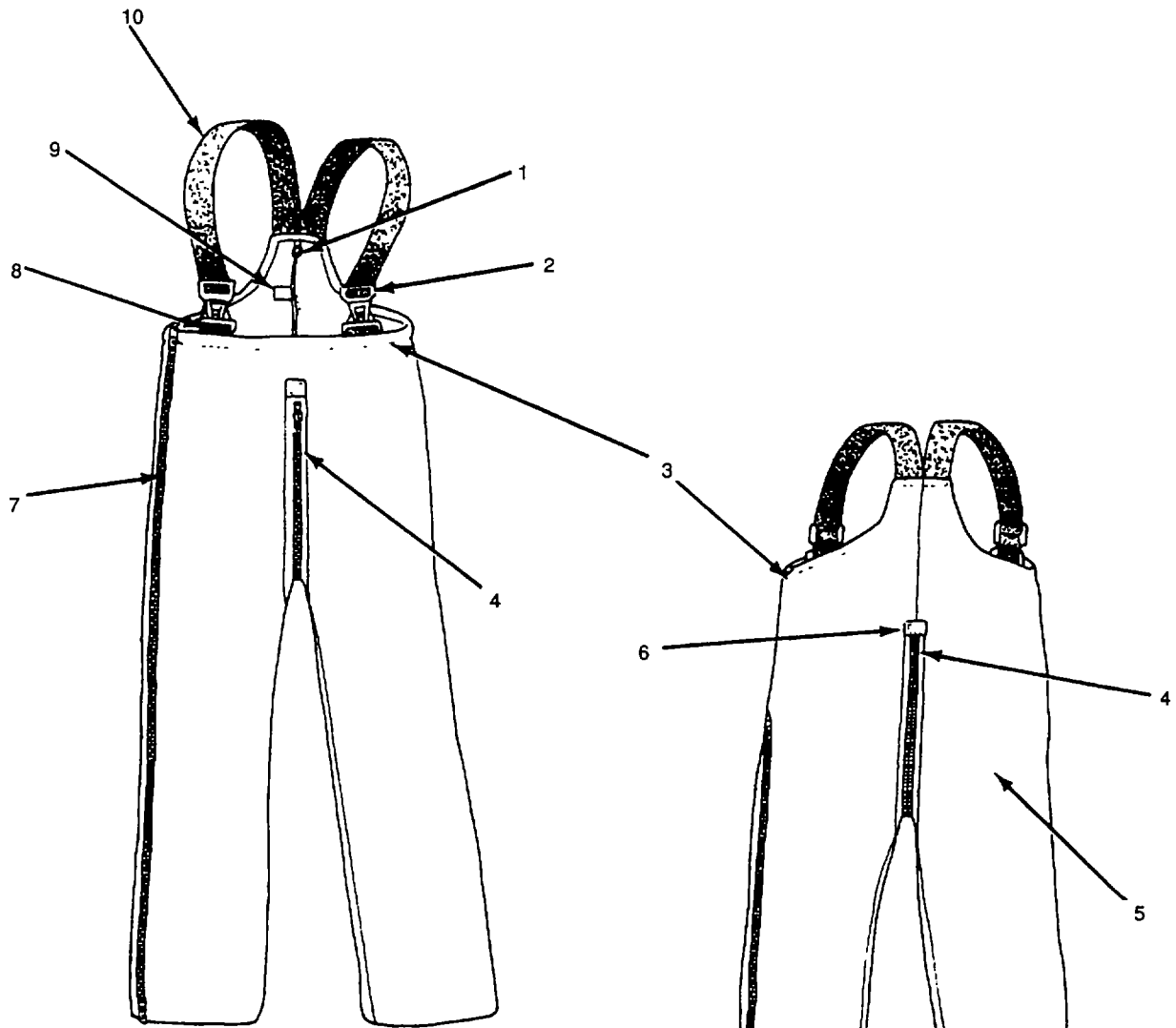

FRONT VIEW

BACK VIEW

LEGEND:

- 1. Nylon Tape
- 2. Suspender Fasteners
- 3. Thread
- 4. Front to Back Slide Fastener
- 5. Pile Cloth
- 6. Webbing
- 7. Full Length Slide Fastener
- 8. Webbing
- 9. Labels
- 10. Suspenders

Figure 20-6. Overall, Bib, Cold Weather, Fiberpile

20-3. IDENTIFICATION AND DESCRIPTION - Continued

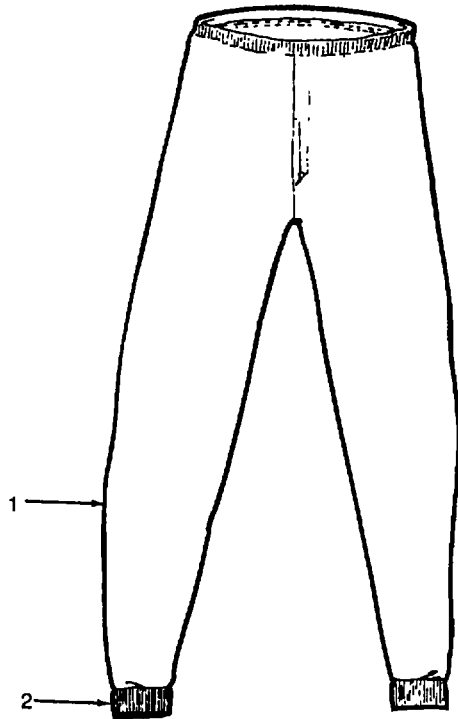

- LENGEND:
- 1. Cloth Knitted Terry Polypropylene
 - 2. Cuff Material

Figure 20-7. Drawers, Cold Weather, Polypropylene

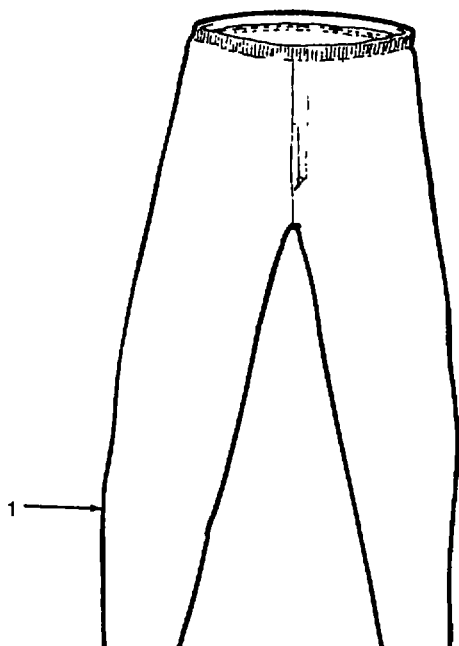

- LENGEND:
- 1. Cloth Knitted Terry Polypropylene
 - 2. Cuff Material

Figure 20-8. Undershirt, Cold Weather, Polypropylene

20-3. IDENTIFICATION AND DESCRIPTION - Continued I

LEGEND:

- 1 Label
- 2 Thread
- 3 Fastener Tape, Hook
- 4 Snap Fastener
- 5 Copper Wire
- 6 Cloth, Water-Proof
- 7 Cloth, Synthetic Fur

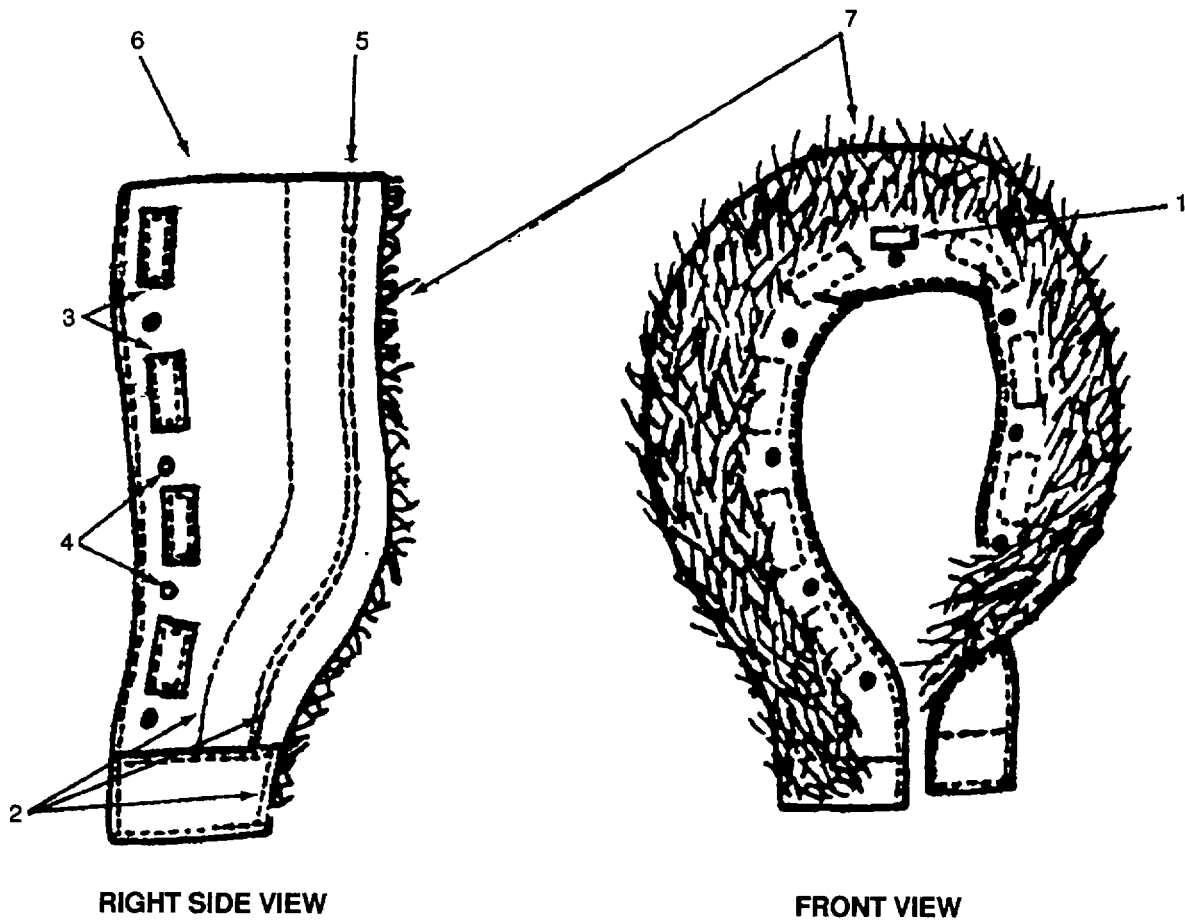

Figure 20-8.1. Ruff, Parka, Extended Cold Weather

20-3. IDENTIFICATION AND DESCRIPTION - Continued

The undershirt (Figure 20-8) is a brown-colored turtleneck that has a centerfront slide fastener which extends to the middle of the chest area. The slide fastener allows for ventilation at the neck and chest area. The various garment sizes are listed in Table 20-20.

- i. Hood, Balaclava, Cold Weather.

NSN	SIZE	SPECIFICATION
8415-01-310-0606	One size	A-A-50194

The balaclava is constructed of two piles of a black wool or a wool blend knitted cloth with a wind barrier interlining. The design is a pull-over-the-head style with an adjustable face opening. There are no repair procedures for the balaclava as it is a non-repairable item.

- j. Ruff, Parka, Extended Cold Weather

NSN	SIZE	SPECIFICATION
8415-01-315-9765	X-Small	MIL-R-44354
8415-01-315-9766	Small	MIL-R-44354
8415-01-315-9767	Medium	MIL-R-44354
8415-01-315-9768	Large	MIL-R-44354
8415-01-315-9769	X-Large	MIL-R-44354

The ruff (Figure 20-8.1) is a camouflage printed item with synthetic fur material on the side facing the face and hook and pile, and male snap fasteners on the opposite side, opposite end. The fasteners allow this item to be attached to the Parka, Extended Cold Weather. The main body cloth for the ruff is the same tri-laminate material used in the ECWCS Parka and Trousers and described in Military Specification MIL-C-44187.

Section II. MAINTENANCE PROCEDURES

20-4. MATERIALS

Materials used to repair the ECWCS shall be serviceable materials recovered from similar salvaged items or new materials that conform to the specifications listed in Section III.

20-5. CLASSIFICATIONS

Serviceability classification for the ECWCS shall be determined in accordance with Chapter 1.

20-6. CLEANING AND LAUNDERING

- a. Machine/Laundry. The shirt and overalls are to be laundered using a delicate/gentle fabric cycle or by hand, using cold water (up to 85° F (27° C)) and cold water laundry detergent. Rinse in clear cold water.

CAUTION

Do not use chlorine bleach or starch. Discoloration and degradation of Infrared protection capacity of the material will result.

20-6. CLEANING AND LAUNDERING - Continued**CAUTION**

To prevent damage to the parka and trousers, dryer temperature should not exceed 90°F (32°C). Avoid over drying and do not press since this will cause degradation to the component materials of the fabric laminate.

The coat and trouser liners shall be laundered using the permanent press fabric cycle or by hand, using warm water (90°F) and mild soap or detergent. Rinse thoroughly, and drip dry or tumble dry, medium setting. **DO NOT DRY CLEAN.**

The undershirt and drawers are to be laundered using delicate wash cycle or wash by hand in cold water (85° F) and cold water detergent. Rinse in clean cold water.

CAUTION

Do not bleach or starch. Discoloration and degradation of material will result.

Dry all components of the ECWCS, except the fur ruff, at lowest fabric cycle such as delicate/gentle. Remove immediately at end of drying cycle. To drip dry, remove from water and place garment on a rustproof hanger.

CAUTION

Do not use bleach, starch or dry clean. Discoloration and degradation of infrared protection capacity of the material will result.

The fur ruff shall be laundered using the permanent press fabric cycle or by hand, using warm water (90°F) and a mild soap or detergent. Rinse thoroughly and drip dry. Do not tumble dry. **DO NOT DRY CLEAN.**

- b. Field Laundering. The coat liners, trouser liners, shirt and overalls are to be laundered using Formula II and the parka and trousers Formula VIII of FM 10-280.

CAUTION

To prevent damage to ECWCS, dryer temperature should not exceed 90° F. Avoid over drying and do not press. Degradation to the component materials of the fabric laminate will result.

Dry all components of the ECWCS, except the fur ruff, in a tumble dryer, loaded not more than 2/3 of rated capacity at lowest fabric cycle Remove immediately from dryer

The fur ruff is to be laundered in accordance with FM 10-280, Mobile Field Laundering, Clothing Exchange, and Bath Operations, Wool Method, Formula II. Field Laundering Method with wash and rinse temperature of 90°F. The fur ruff must be air dried at room temperature Do not put in any type of dryer or expose fur ruff to heat above 90°F (doing so causes the fur ruff material to become matted and non-functional). **DO NOT DRY CLEAN.**

- c. Post (Fixed) Laundry. Parka, and trousers shall be laundered utilizing Natick Formula I. Shirt, overalls, I drawers and undershirt should be laundered utilizing Natick IV.

20--7. REPAIR I

- a. General. Prior to repair operations, each item shall be inspected by qualified personnel to determine the extent of repair necessary. All repairs to the components of the ECWCS will be accomplished at the direct support level. FM 10-16 will be used as a general guide.
- b. Repair Procedures:
 - (1) Preliminary Examination. Remove all dirt, mud, dust, spots, stains and other foreign matter a brush before examining the garment. Rotten items will be discarded, seams will be tested by grasping the item with both hands and pulling at right angles to the seams. Areas to be repaired shall be marked with crayons. Nonspecific and personal marks shall be erased or obliterated

207. REPAIR - Continued

(2) Rips and tears.

- (a) Any stitching/restitching/patching required to repair the parka and trousers must be heat sealed before the garment is placed back into service. This will prevent water from penetrating through the holes created during stitching.
- (b) Heat sealing tape is used to repair rips up to 25 inches missing the inner tricot knit of garments, and to seal restitched seams. Sealing is necessary to maintain the waterproof characteristics of the garment. The entire width of the sealing tape shall be hot adhesive sealed over the seam or stitching on the inside. The sealer heat seam, coverall, NSN 3540-01-186-7869 (Part No. 1525AS102-1, FSCM 81337) is used to apply heat and pressure to the adhesive coated seam tape and patches in order to affix them permanently to the outer shell cloth. All seam tapes shall overlap a minimum of 3/4 inch at joining points. Up to three repairs totaling 15 inches may thus be applied to the parka or trousers. Seam tape may also be used to repair areas where the original tape does not overlap sewn seams by the minimum 1/8 inch on both sides.
- (c) If the heat seam sealer is not available, a commercial iron on a high steam setting, or a tailoring iron on a medium setting may be used.

CAUTION

Temperature of iron shall not exceed 350°F with the addition of steam to prevent melting of the nylon tricot layer of the fabric. The following steps are to be followed:

- 1. Test temperature of iron to ensure proper setting. Apply heat to sample piece of heat sealing tape to ensure nylon tricot layer does not melt. Adjust setting if necessary.
- 2. To apply heat sealing tape, place appropriate length of tape to inside of garment on area to be repaired. With adhesive side of the tape against repair apply iron in one location at a time. Do not slide the iron back and forth. Apply pressure for 15 seconds. Turn garment to right side and apply iron to same area again for 15 seconds to allow heat sealing tape to set.
- (d) Holes or worn areas on the liners which exceed 1/8 inch shall be patched and darned. Precut patches of matching material for uniformity. Cut patches to extend approximately 3/4 Inch around perimeter of opening, providing not less than 3/8 inch turn-under at all edges except selvage edges. Darn holes and worn areas of less than 1/4 Inch. Turn under frayed hems and edges and restitch. Use sharp needles to sew lining to prevent large needles holes or cutting fabric.

(3) Stitching and restitching

- (a) The location, stitch type, thread side, and stitches per inch for the various ECWCS components are listed in Tables 20-1 through 20-5. All stitches, seams, and stitching shall conform to FED-STD-751. Seam allowances shall be maintained with seams sewn so no raw edges, run-offs, pleats, puckers, or open seams occur. When two or more methods of stitching are given for the same operation, any one may be used.
- (b) Any stitching/restitching/patching required to repair the parka and trousers must be heat sealed before the garment may be placed back into service. This will prevent water from penetrating through the holes created during stitching.

20-7. REPAIR- Continued

- (c) The ends of all stitching on the liners shall be backstitched or bartacked at ends to prevent raveling. Maintain proper thread tension to prevent loose stitching and to imbed the lock in the center of the material sewn. The looper thread shall be on the outside of the garment. Backstitch type 301 stitching not less than 1 inch at each end of break. Overlock thread breaks in overedge stitching not less than 3/4 inch. Thread size shall conform to V-T-276 of the types and sizes listed In Table 20-2.1.
- (4) Liner Buttons and Buttonholes. Replace damaged or missing buttons with matching serviceable or new buttons. Properly align replacement button with corresponding buttonhole. Rework damaged buttonholes over gimp to match original design. Pull and shape by hand or machine stitch a small matching reinforcement patch on the underside, and rework through the patch.
- (5) Binding Tape for Liners. Overlap the damaged binding tape with new tape extending 1 inch beyond the damaged area. Turn binding edges under 1/2 Inch and stitch 1/8 inch from edge of tape.

Table 20-1. Stitching Instructions (Parka)

LOCATION	STITCH TYPE	THREAD		STITCHES PER INCH
		NEEDLE	BOBBIN	
General	301	B	B	10-13
Assembling hood, upper, and complete lining	515 or 516	B	B	10-13
Bartacking windskirt on seam	1/2" bartack	B	B	28 each
Bartacking hood tunnel and drawcord	5/8" bartack	B	B	21 to 28 each

Table 20-2. Stitching Instructions (Trousers)

LOCATION	STITCH TYPE	THREAD		STITCHES PER INCH
		NEEDLE	BOBBIN	
General	301	B	B	10-13
Assembling suspender loops	3/8" bartack	B	B	21-28 each
Assembling front fly (Overedge stitch)	504 or 516	B	B	10-13
Hemming waistband seam (Overedge stitch)	515 or 516	B	B	10-13
Hemming waistband (General & Overedge)	301	B	B	10-13

20-7. REPAIR - Continued

Table 20-2.1 *Stitching Instructions (Coat and Trouser Liners)*

LOCATION	STITCH TYPE	THREAD		STITCHES PER INCH
		NEEDLE	BOBBIN	
General	301 or 401	B B	B AA	10-14 10-14
Buttonhole	---	B	B	52-56 (buttonhole)
Button	301 or 101	B B	B -	14-16 20-24
Overedging	503 or 504	-- --	AA --	8-10
Bartacking		B	B	28 (bartack)

Table 20-3 *Stitching Instructions (Shirt)*

LOCATION	STITCH TYPE	THREAD		STITCHES PER INCH
		NEEDLE	BOBBIN	
General	301	B	B	8-10
Assembling breast pockets (over-edge stitch)	502 or 503	B	B	8-10
Stitching breast pockets, cut-out corners	301 or 401	B	B	8-10
Assembling shirt join fronts to sleeves, stitch underarm insert to fronts and sleeves; join back to sleeves, collar, and side seams and sleeve seam	515, 516, 519	B	B	8-10
Attaching shirt sleeve, front, and back seams	301 or 515 516, 519	B	B	8-10

Table 20-4. *Stitching Instructions (Bib Overall)*

LOCATION	STITCH TYPE	THREAD		STITCHES PER INCH
		NEEDLE	BOBBIN	
General	301	B	B	8-10
Assembling overall around periphery of all pattern pieces (Overedge stitch)	502 or 503	B	B	8-10

Table 20-5. *Stitching Instructions (Drawers and Under shirt)*

LOCATION	STITCH TYPE	THREAD		STITCHES PER INCH
		NEEDLE	BOBBIN	
Stitch, slide fastener to collar (undershirt only)	301 or 401	100	100	2-16
Repair Seams	503 or 504	100	100	12-16

20-7. REPAIR - Continued

- (6) Repair of 301 stitching. Ends of all stitching shall be backstitched or overstitched not less than 1/2 inch (1.25 cm) except where ends are turned under or caught in other seams or stitching. Ends of a continuous line of stitching shall overlap not less than 1/2 inch (1.25 cm). Thread tensions shall be not less than 1/2 inch (1.25 cm). Thread tensions shall be maintained so that there will be no loose stitching resulting in loose bobbin or top thread or excessively tight stitching resulting in puckering of materials sewn. The lock shall be embedded in the materials sewn. When thread breaks, skipped stitches, run-offs, or bobbin runouts occur during sewing, stitching shall be repaired by restarting the stitching a minimum of 1/2 inch (1.25 cm) back of end of the interrupted stitching. Except for prestitching, thread breaks of two or more consecutive skipped or run-off stitches noted during inspection of the item shall be repaired by overstitching. The stitching shall start a minimum of 1/2 inch (1.25 cm) in back of defective area, continue over the defective area onto the existing stitching. Loose or excessively tight stitching shall be repaired by removing defective stitching without damaging the materials, and restitching in the required manner. When making above repairs, ends of stitching need not be backstitched.
- (7) Type 401,502,503, 515,516, and 519 Stitching. These type stitchings are repaired in the same manner as type 301, except that repairs to type 401 stitching requires both ends of all seams to have 1/2 inch (1.30 cm) minimum chain extending beyond each end unless they are caught in a seam or other stitching.
- (8) Bartacks. Unless otherwise specified, all bartacks shall be 3/8 +1 1/16 inch (1 +10 cm) long and 1/8 +1/32 inch (0.35 +0.10 cm) wide, and shall contain 28 stitches. Bartacking shall be free from thread breaks and loose stitching.
- (9) Slide Fasteners. Replace damaged, missing, or malfunctioning slide fasteners with serviceable ones. Slide fasteners are not seam sealed in; remove the one to be replaced and sew in a new one.
- (10) Snap Fasteners. Replace missing, loose, or damaged snap fasteners. Patch damaged area surrounding snap fastener sockets and studs prior to attaching snap fasteners.
- (11) Drawcords and Barrel Locks. Replace missing or defective drawcords in lengths to match original construction. Drawcord ends shall be heat seared and knotted. Refer to Table 20-6 through Table 20-8 for proper lengths. Replace Barrel Locks as required.

Table 20-6.

ITEM	X-Small In Cm	Small In Cm	Medium In Cm	Large In Cm	X-Large In Cm	Tolerance In Cm
Hood Drawcord	32 1/2 82.50	33 83.85	33 1/2 85	34 1/4 87	34 3/4 88.25	±1 ± 2.50
Windskirt Drawcord	41 1/2 105.50	45 1/2 115.50	49 1/2 125.50	53 1/2 135.85	57 1/2 146	±1 ± 2.50
Windskirt Webbing	23 3/4 60.50	26 3/4 68	30 3/4 78.10	34 3/4 88.25	38 3/4 98.50	±1 ±2.50
Hanger Tape	4 1/2 11.50	4 1/2 11.50	4 1/2 11.50	4 1/2 11.50	4 1/2 11.50	±1 ± 2.50

20-7. REPAIR - Continued

Table 20-7. Drawcord and Tape Lengths (Trousers)

ITEM	X-Small In Cm	Small In Cm	Medium In Cm	Large In Cm	X-Large In Cm	Tolerance In Cm
Drawcord	38 96.50	42 106.65	46 116.85	50 127	54 137.10	± 1 +2.50
Fastener Tapes, Hook	1 1/2 3.85	1 1/2 3.85	1 1/2 3.85	1 1/2 3.85	1 1/2 3.85	± 1 +2.50
Fastener Tapes, Pile	6 3/4 17.10	6 3/4 17.10	6 3/4 17.10	6 3/4 17.10	6 3/4 17.10	± 1 ± 2.50
Suspender Loops	6 15.25	6 15.25	6 15.25	6 15.25	6 15.25	± 1 -250

Table 20-8. Drawcord Lengths (Shirt)

ITEM	X-Small In Cm	Small In Cm	Medium In Cm	Large In Cm	X-Large In Cm	Tolerance In Cm
Hem	39 3/4	41 3/4	43 3/4	45 3/4	47 3/4	. =
Drawcord	101	106	111.10	116.25	121.25	. 2.50
Hanger	5 1/2	5 1/2	5 1/2	5 1/2	5 1/2	. =
Tape	14	14	14	14	14	. 2.50

(12) Elastic Webbing. Replace defective elastic webbing at bottom of shirt.

(13) Hangers. Replace defective or missing neck hanger loops. Construct hangers by folding a strip of Tape, Textile (Refer to Section III, Figure 20-5 Item 2) and double stitch on the underside.

(14) Pocket Flaps. Repair or replace tom, missing, or defective flaps. Restitch ripped seams or loose B stitching.

(15) Pockets. Restitch loose or ripped pockets. Replace missing or defective pockets with new ones using the following materials:

(a) Parka and Trousers: Cloth, Laminated, Waterproof, Moisture-Vapor Permeable conforming to MIL-C-44187 (Refer to Section III, Figure 20-2 Item 1 and Figure 20-3 Item 6)

(b) Shirt: Cloth, Pile, Synthetic, Fiberpile brown 463, class 4, conforming to MIL-C-43251 (Refer to Section III, Figure 20-5 Item 11)

20-7. REPAIR - Continued

To attach pockets and flaps to fronts, turn in edges of breast pocket 1/2 inch (1.25 cm) if not prehemmed. Position pockets and stitch 1/16 to 1/8 inch (0.15 to 0.35 cm) from folded edge around sides and bottom, tacking tops. Position breast pocket flap above pockets so line of stitching will lay away from pocket. Stitch to fronts 3/16 to 1/4 inch (0.50 to 0.65 cm) from overedged edge. Turn flap sewn and raise stitch 1/4 to 5/16 inch (0.65 to 0.90 cm) from fold, tacking ends. Turn pocket opening side of handwarmer pockets on shirt to inside and stitch 3/8 to 1/2 inch (1 to 12.5 cm) from folded edge for hem. Position handwarmer pockets, turning seam allowance under and stitch 1/8 to 3/16 inch (0.35 to 0.50 cm) from folded edges.

- (16) Eyelets: Replace missing, loose, badly split and off center eyelet holes. Darn enlarged eyelet holes with polyester thread. Punch holes receiving eyelets smaller than outside diameter of eyelet barrel so that barrel must be forced through the material.

Table 20-9. Side Fastener Lengths (Undershirt)

ITEM	X-Small In Cm	Small In Cm	Medium In Cm	Large In Cm	X-Large In Cm
Replace Slide Fastener	12 1/8	12 1/4	12 3/8	12 1/2	12 5/8

- (17) Ruff: The ruff has a 1 inch wide hook fastener tape (with an approximate cut length of 2 inches), Olive Green 106 for the attachment points connecting the ruff to the ECWCS Parka and 2 inch wide hook and loop fastener tape (with an approximate cut length of 3 3/8 inches), Olive Green 106 for the ends of the ruff. Both tapes shall conform to type II, class 1 of MIL-F-21840. The ruff also has male (stud and post) snap fasteners, style 2A, conforming to MIL-F-10884.

Table 20-9. 1. Stitching Instructions (Ruff)

LOCATION	STITCH TYPE	THREAD		STITCHES PER INCH
		NEEDLE	BOBBIN	
General	301	B	B	10-13

20-8. RESIZING

After cleaning and repair, resize garments according to sizes listed in Tables 20-10 through 20-15 below. When garments vary in size from original marking, obliterate old marking and re-mark with proper size using indelible pencil or waterproof ink. When actual measurements do not correspond to the size indicated, relabel to the next lowest size.

20-8. RESIZING - Continued

Table 20-10. Finished Measurements (Parka)

Size	1/2 Chest <u>1/</u> In (Cm)	Back Length <u>2/</u> In (Cm)	Sleeve length <u>3/</u> In (Cm)
X-Short			
X-Small	21 (53.35)	24 1/2 (62.25)	26 1/4 (66.65)
Small	23 (58.50)	25 (63.50)	26 1/2 (67.35)
Medium	25 (63.50)	25 1/2 (64.75)	26 3/4 (68)
Short			
X-Small	21 (53.35)	25 1/2 (64.75)	26 3/4 (68)
Small	23 (58.50)	26 (66)	27 (68.65)
Medium	25 (63.50)	26 1/2 (67.35)	27 1/4 (69.25)
Large	27 (68.65)	27 (68.55)	27 1/2 (69.85)
Regular			
X-Small	21 (53.35)	27 (68.65)	27 3/4 (70.50)
Small	23 (58.50)	27 1/2 (69.85)	28 (71.10)
Medium	25 (63.50)	28 (71.10)	28 1/4 (71.75)
Large	27 (68.65)	28 1/2 (72.50)	28 3/4 (73)
Long			
X-Small	21 (53.35)	28 1/2 (72.50)	28 3/4 (73)
Small	23 (58.50)	29 (73.65)	29 (73.65)
Medium	25 (63.50)	29 1/2 (75)	28 3/4 (73)
Large	27 (68.65)	30 (76.25)	29 1/2 (75)
X-Large	29 (73.65)	30 1/2 (77.50)	29 3/4 (75.60)
Tolerance	+ 3/4 (2)	+ 3/4 (2))	± 1/2 (1.25)

1/ With slide fastener closed and parka smoothed flat, measure 1/2 chest from folded edge at base of armhole seams.

2/ Measure center back length from neck seam to bottom of hem.

3/ Measure sleeve length from armhole seam to bottom of sleeve along underarm seam.

20-8. RESIZING - Continued

Table 20-11. Finished Measurements (Trousers)

Size	1/2 Chest ^{1/} In (Cm)	Inseam ^{2/} In (Cm)	Sleeve length ^{3/} In (Cm)
X-Short			
X-Small	15 (38)	26 1/2(67.35)	35 (89)
Small	17 (43.10)	26 1/2(67.35)	35 1/2 (90.25)
Medium	19 (48.25)	26 1/2 (67.35)	36 (91.50)
Short			
X-Small	15 (38)	28 1/2(72.50)	37 1/2 (95.25)
Small	17 (43.10)	28 1/2(72.50)	38 (96.50)
Medium	19 (48.25)	28 1/2 (72.50)	38 1/2 (97.75)
Large	21 (53.35)	28 1/2 (72.50)	39 (99)
Regular			
X-Small	15 (38)	30 1/2(77.50)	40 (101.60)
Small	17 (43.10)	30 1/2 (77.50)	40 1/2 (102.85)
Medium	19 (48.25)	30 1/2 (77.50)	41 (104.10)
Large	21 (53.35)	30 1/2 (77.50)	41 1/2 (105.40)
X-Large	23 (58.40)	30 1/2 (77.50)	42 (106.65)
Long			
X-Small	15 (38)	32 1/2 (82.50)	42 1/2 (108)
Small	17 (43.10)	32 1/2 (82.50)	43 (109.25)
Medium	19 (48.25)	32 1/2 (82.50)	43 1/2 (110.50)
Large	21 (53.35)	32 1/2 (82.50)	44 (111.75)
X-Large	23 (58.40)	32 1/2 (82.50)	44 1/2 (113)
Tolerance	. 1 1/2(1.25)	. 3/4 (2)	. 1/2 (1.25)

1/ With Trousers fastened, measure along center of waistband from folded edge to folded edge.

2/ Measure inseam of trousers from crotch seam to bottom edge of trouser leg hem.

3/With trouser flat, measure from top of waistband to trouser leg hem.

Table 20-11.1. Finished Measurements (Coat Liner)

SIZE	1/2 CHEST ¹ INCHES	BACK LENGTH ² INCHES	SLEEVE LENGTH ³ INCHES
X-Small	23	27 1/2	22
Small	25	28	22 1/2
Medium	27	28 1/2	23
Large	29	29	23 1/2
X-Large	31	29 1/2	24
Tolerance	±3/4	+1/2	±1/2

1 1/2 chest measurement taken with the liner flat and the front edges abutting, from folded edge to folded edge at the base of armhole.

2 Back length measurement taken along center back from edge of neck to bottom edge of liner.

3 Sleeve measurement taken from center of top sleeve to bottom edge of sleeve.

20-8. RESIZING - Continued

Table 20-11.2. Finished Measurements (Trousler Liner)

INCHES	1/2 WAIST ¹	INSEAM SHORT & REGULAR	INSEAM LONG
	INCHES	INCHES	INCHES
X-Small	17 1/2	22	26
Small	19 1/2	22	26
Medium	21 1/2	22	26
Large	23 1/2	22	26
X-Large	25 1/2	22	26
Tolerance	+3/4 -1/2	+ 3/4	+3/4

¹ Measurement taken with the waist buttoned, and the liner laid flat and smooth. Measure across front at center of the waistband from side edge to side edge.

Table 20-12. Finished Measurements (Shirt)

Size	1/2 Chest <u>1</u> / In (Cm)	Sleeve Length <u>2</u> / In (Cm)	Back length <u>3</u> / In (Cm)
X-Small	18 5/8 (47.35)	32 1/4 (82)	26 3/4 (68)
Small	20 5/8 (52.40)	33 1/4 (84.50)	27 1/4 (69.25)
Medium	22 5/8 (57.50)	34 1/4 (87)	27 3/4 (70.50)
Large	24 5/8 (62.50)	35 1/4 (89.50)	28 1/4 (71.75)
X-Large	26 5/8 (67.60)	36 1/4 (92)	28 3/4 (73)
Tolerance	+ 1/2 (1.25)	+ 3/4 (2)	+ 3/4 (2)

1/ With the slide fastener closed, and shirt laying flat and as smooth as possible, continue an imaginary seam line from the sleeve and front yoke seam to a point under the arm dividing the underarm insert approximately in half.

2/ Measure from center back at collar, diagonally to sleeve yoke point, at center edge of sleeve hem.

3/ Measure down center back from collar seam to bottom edge of shirt.

Table 20-13. Finished Measurements (Bib Overall)

Size	1/2 Chest <u>1</u> / In (Cm)	Back Length <u>2</u> / In (Cm)	Outseam <u>3</u> / In (Cm)
	X-Small	16 (40.65)	23 (58.50)
X-Small/Long	16 (40.65)	27 (68.50)	42 (106.65)
Small	18 (45.75)	23 (58.50)	38 (96.50)
Small/Long	18 (45.75)	27 (68.50)	42 1/2 (108)
Medium	20 (50.85)	23 (58.50)	38 1/2 (97.75)
Medium/Long	20 (50.85)	27 (68.50)	43 (109.25)
Large	21 (53.35)	23 (58.50)	39 (99)
Large/Long	21 (53.35)	27 (68.50)	43 1/2 (110.50)
X-Large	22 (55.85)	23 (58.50)	39 1/2 (100.35)
X-Large/Long	22 (55.85)	27 (68.50)	44 (111.75)
Tolerance	+ 1/2 (1.25)	+ 3/4 (2)	+ 3/4 (2)

1/ Half chest measurements taken 1 inch below front top from seam to seam.

2/ Inseam measurements taken from the center of the crotch to the bottom edge of the leg along the seam.

3/ Outseam measurements taken from the top edge of the seam to the bottom edge of the leg.

20-8. RESIZING - Continued

NOTE:

All measurements shall be taken with the slide fasteners closed and the overall placed smooth and flat on a table.

Table 20-14. Finished Measurements (Undershirt)

SIZE	1/2 Cuff Width 5/ In	Cuff Length 6/ In	1/2 Neck 4/ In	112 Chest 1/ In	Back Length 2/ In	Sleeve Length 3/ In
X-Small	3 1/2	2 1/2	7 1/2	19	25 1/4	19
Small	3 1/2	2 1/2	7 3/4	21	26 1/4	20
Medium	4	2 1/2	8	23	27 1/4	21
Large	4	2 1/2	8 1/4	25	28 1/4	22
X-Large	4 1/2	2 1/2	8 1/2	27	29 1/4	23

- 1/ Measure at base of armhole, from folded edge to folded edge.
- 2/ Measure along center back, from collar seam to bottom of undershirt.
- 3/ Measure along underarm, from bottom of cuff to armhole seam.
- 4/ With slide fastener closed, measure from folded edge to folded edge.
- 5/ Measure cuff width at center of cuff, from folded edge to folded edge
- 6/ Measure from base of sleeve to bottom of cuffs.

Table 20-15. Finished Measurements (Drawers)

Size	1/2 Waist 1/ In	Inseam 2/ In	1/2 Cuff Width 3/ In	1/2 Cuff Length 4/ In
X-Small	10 1/2	28 1/2	3 1/2	3
Small	11 1/2	29 1/2	3 1/2	3
Medium	12 1/2	30 1/2	4	3
Large	13 1/2	31 1/2	4	3
X-Large	14 1/2	32 1/2	4 1/2	3

- 1/ Measure along center of waistband, from folded edge to the folded edge.
- 2/ Measure Inseam of drawers from crotch seam to bottom edge of drawers leg cuff.
- 3/ Measure width of cuff from folded edge at center of cuff.
- 4/ Measure length of cuff from seam edge of ribbing to bottom edge of hem.

Table 20-15.1. Finished Measurements (Ruff)

	X-Small	Small	Medium	Large	X-Large	Tolerance
Length 1 In	34	34 1/2	35 1/2	35 3/4	36 1/4	. 1/4

1/ The finished measurement shall be taken with the ruff lying flat on a table, fur face down, and measuring from end to end along the snap fastener edge.

The ruff is designed to fit the ECWCS parka of the same size.

20-8. RESIZING - Continued

Table 20-16. Parka Sizes

X-Small X-Short

Height: Up to 63 in
 Chest Mn: Up to 33 in
 Chest Wn: Up to 36 in
 NSN: 8415-01-228-1306
 NATO Size: 5060/7484

Small X-Short

Height: Up to 63 in
 Chest Mn: 33 to 37 in
 Chest Wn: 36 to 40 in
 NSN: 8415-01-228-1310
 NATO Size: 5060/8494

Medium X-Short

Height: Up to 63 in
 Chest Mn: 37 to 41 in
 Chest Wn: 40 to 44 in
 NSN: 8415-01-228-1314
 NATO Size: 5060/9404

X-Small Short

Height: 63 to 67 in
 Chest Mn: Up to 33 in
 Chest Wn: Up to 36 in
 NSN: 8415-01-228-1307
 NATO Size: 6070/7484

X-Small Long

Height: 71 in and up
 Chest Mn: Up to 33 in
 Chest Wn: Up to 36 in
 NSN: 8415-01-228-1309
 NATO Size: 8090/7484

Small Long

Height: 71 in and up
 Chest Mn: 33 to 37 in
 Chest Wn: 36 to 44 in
 NSN: 8415-01-228-1313
 NATO Size: 8090/8494

Small Short

Height: 63 to 67 in
 Chest Mn: 33 to 37 in
 Chest Wn: 36 to 40 in
 NSN: 8415-01-228-1311
 NATO Size: 6070/8494

Medium Short

Height: 63 to 67 in
 Chest Mn: 37 to 41 in
 Chest Wn: 40 to 44 in
 NSN: 8415-01-228-1315
 NATO Size: 6070/9404

Large Short

Height: Up to 67 in
 Chest: 41 to 45 in
 NSN: 8415-01-228-1318
 NATO Size: 6070/0414

X-Small Regular

Height: 67 to 71 in
 Chest Mn: Up to 33 in
 Chest Wn: Up to 36 in
 NSN: 8415-01-228-1308
 NATO Size: 7080/7484

Medium Long

Height: 71 in and up
 Chest Mn: 37 to 41 in
 Chest Wn: 40 to 44 in
 NSN: 8415-01-228-1317
 NATO Size: 8090/9404

Large Long

Height: 71 in and up
 Chest Mn: 41 to 45 in
 NSN: 8415-01-228-1310
 NATO Size: 8090/0414

Small Regular

Height: 67 to 71 in
 Chest Mn: 33 to 37 in
 Chest Wn: 36 to 40 in
 NSN: 8415-01-228-1312
 NATO Size: 7080/8494

Medium Regular

Height: 67 to 71 in
 Chest Mn: 37 to 41 in
 Chest Wn: 40 to 44 in
 NSN: 8415-01-228-1316
 NATO Size: 7080/9404

Large Regular

Height: 67 to 71 in
 Chest: 41 to 45 in
 NSN: 8415-01-228-1319
 NATO Size: 7080/0414

X-Large Regular

Height: 67 to 71 in
 Chest MN: 45 in and up
 NSN: 8415-01-228-1322
 NATO Size: 7080/1424

X-Large Long

Height: 71 in and up
 Chest Mn: 45 in and up
 NSN: 8415-01-228-1322
 NATO Size: 8090/1424

20-8. RESIZING - Continued**Table 20-17. Trousers Sizes****X-Small X-Short**

Inseam: to 26 1/2 in
 Waist: Up to 27 in
 NSN: 8415-01-228-1336
 NATO Size: 6067/5869

X-Small Regular

Inseam: 29 1/2 to 32 1/2 in
 Waist: Up to 27 in
 NSN: 8415-01-228-1338
 NATO Size: 7583/5869

Small X-Short

Inseam: to 26 1/2 in
 Waist: 27 to 31 in
 NSN: 8415-01-228-1340
 NATO Size: 6067/6979

Small Regular

Inseam: 29 1/2 to 32 1/2 in
 Waist: 27 to 31 in
 NSN: 8415-01-228-1342
 NATO Size: 7583/6979

Medium X-Short

Inseam: to 26 1/2 in
 Waist: 31 to 25 in
 NSN: 8415-01-228-1344
 NATO Size: 6067/7989

Medium Regular

Inseam: 29 1/2 to 32 1/2 in
 Waist: 31 to 35 in
 NSN: 8415-01-228-1346
 NATO Size: 7583/7989

Large Short

Inseam: 26 1/2 to 29 1/2 in
 Waist: 35 to 39 in
 NSN: 8415-01-228-1348
 NATO Size: 6775/8999

Large Long

Inseam: 32 1/2 to 35 1/2 in
 Waist: 35 to 39 in
 NSN: 8415-01-228-1350
 NATO Size: 8390/8999

X-Large Long

Inseam: 32 1/2 to 35 1/2 in
 Waist: Over 39 in
 NSN: 8415-01-228-1352
 NATO Size: 8390/9909

X-Small Short

Inseam: 26 1/2 to 29 1/2 in
 Waist: Up to 27 in
 NSN: 8415-01-228-1337
 NATO Size: 6775/5869

X-Small Long

Inseam: 32 1/2 to 35 in
 Waist: Up to 27 in
 NSN: 8415-01-228-1339
 NATO Size: 8390/5869

Small Short

Inseam: 26 1/2 to 29 1/2 in
 Waist: 27 to 31 in
 NSN: 8415-01-228-1341
 NATO Size: 6775/6979

Small Long

Inseam: 32 1/2 to 35 1/2 in
 Waist: 27 to 31 in
 NSN: 8415-01-228-1343
 NATO Size: 8390/6979

Medium Short

Inseam: 26 1/2 to 29 1/2 in
 Waist: 31 to 35 in
 NSN: 8415-01-228-1345
 NATO Size: 6775/7989

Medium Long

Inseam: to 35 1/2 in
 Waist: 31 to 35 in
 NSN: 8415-01-228-1347
 NATO Size: 8390/7989

Large Regular

Inseam: 29 1/2 to 32 1/2 in
 Waist: 35 to 39 in
 NSN: 8415-01-228-1349
 NATO Size: 7583/8999

X-Large Regular

Inseam: 29 1/2 to 32 1/2 in
 Waist: Over 39 in
 NSN: 8415-01-228-1351
 NATO Size: 7583/9909

20-8. RESIZING - Continued**Table 20-17.1. Coat Liner Sizes****X-Small X-Short**

Height: Up to 63 in
 Chest Men's: Up to 33 in
 Chest Women's: Up to 36 in
 NSN: 8415-01-062-0679
 NATO Size: 5060/7484

Small

Height: Over 63 in
 Chest Men's: 33 to 37 in
 Chest Women's: 36 to 40 in
 NSN: 8415-00-782-2887
 NATO Size: 7080/8494

Large

Height: Over 63 in
 Chest Men's: 41 to 45 in
 NSN: 8415-00-782-2889
 NATO Size: 7080/0414

X-Small

Height: Over 63 in
 Chest Men's: Up to 33 in
 Chest Women's: Up to 36 in
 NSN: 8415-00-782-2886
 NATO Size: 7080/7484

Medium X-Small

Height: Up to 63 in
 Chest Men's: 37 to 41 in
 Chest Women's: 40 to 44 in
 NSN: 8415-01-062-0681
 NATO Size: 5060/9404

X-Large

Height: Over 63 in
 Chest Men's: Over 45 in
 NSN: 8415-00-782-2890
 NATO Size: 7080/1424

Small X-Short

Height: Up to 63 in
 Chest Men's: 33 to 37 in
 Chest Women's: 36 to 40 in
 NSN: 8415-01-062-0680
 NATO Size: 5060/8494

Medium

Height: Over 63 in
 Chest Men's: 37 to 41 in
 Chest Women's: 40 to 44 in
 NSN: 8415-00-782-2888
 NATO Size: 7080/9404

Table 20-17.2. Trousler Liner Sizes**X-Small - Short and Regular**

Waist: Below 27 in
 Inseam: Up to 32 1/2 in
 NSN: 8415-00-782-2992
 NATO Size: 6783/5869

Small Long

Waist: From 27 to 31 in
 Inseam: Over 32 1/2 in
 NSN: 8415-00-782-2925
 NATO Size: 8390/6979

Large - Short and Regular

Waist: From 35 to 39 in
 Inseam: Up to 32 1/2 in
 NSN: 8415-00-782-2928
 NATO Size: 6783/8999

X-Large - Long

Waist: From 39 to 43 in
 Inseam: Over 32 1/2 in
 NSN: 8415-00-782-2931
 NATO Size: 8390/9909

X-Small Long

Waist: Below 27 in
 Inseam: Over 32 1/2 in
 NSN: 8415-00-782-2993
 NATO Size: 8390/5869

Medium - Short and Regular

Waist: From 31 to 35 in
 Inseam: Up to 32 1/2 in
 NSN: 8415-00-782-2926
 NATO Size: 6783/7989

Large - Long

Waist: From 35 to 39 in
 Inseam: Over 32 1/2 in
 NSN: 8415-00-782-2929
 NATO Size: 8390/8999

Small Short and Regular

Waist: From 27 to 31 in
 Inseam: Up to 32 1/2 in
 NSN 8415-00-782-2994
 NATO Size. 6783/6979

Medium - Long

Waist: From 31 to 35 in
 Inseam: Over 32 1/2 in
 NSN: 8415-00-782-2927
 NATO Size: 8390/7989

X-Large - Short and Regular

Waist: From 39 to 43 in
 Inseam: Up to 32 1/2 in
 NSN: 8415-00-782-2930
 NATO Size: 6783/9909

20-8. RESIZING - Continued

Table 20-18. Shirt Sizes

X-Small

Chest: Under 33 in
 NSN: 8415-01-228-1353
 NATO Size: 7080/7484

Small

Chest: 33 to 37 in
 NSN: 8415-01-228-1354
 NATO Size: 7080/8494

Medium

Chest: 37 to 41 in
 NSN: 8415-01-228-1355
 NATO Size: 7080/9404

Large

Chest: 41 to 45 in
 NSN: 8415-01-228-1356
 NATO Size: 7080/0414

X-Large

Chest: 45 in and up
 NSN: 8415-01-228-1357
 NATO Size: 7080/1424

Table 20-19. Bib Overall Sizes

X-Small Short/Regular

Inseam: to 32 1/2 In
 Waist: Under 27 in
 NSN: 8415-01-228-1323
 NATO Size: 6783/5869

X-Small Long

Inseam: Over 32 1/2 In
 Waist: Under 27 In
 NSN: 8415-01-228-1324
 NATO Size: 8390/5869

Small Short/Regular

Inseam: to 32 1/2 in
 Waist: 27 to 31 In
 NSN: 8415-01-228-1325
 NATO Size: 6783/6979

Small Long

Inseam Over 32 1/2 in
 Waist: 27 to 31 in
 NSN 8415-01-228-1326
 NATO Size 8390/6979

Medium Short Regular

Inseam' to 32 1/2 In
 Waist: 31 to 35 in
 NSN: 8415-01-228-1327
 NATO Size. 6783/7989

Medium Long

Inseam: Over 32 1/2 In
 Waist: 31 to 35 in
 NSN: 8415-01-228-1328
 NATO Size: 8390/7989

Large Short/Regular

Inseam: to 32 1/2 In
 Waist: 35 to 39 in
 NSN: 8415-01-228-1329
 NATO Size: 6783/8999

Large Long

Inseam: Over 32 1/2 in
 Waist: 35 to 39 in
 NSN: 8415-01-228-1330
 NATO Size: 8390/8999

X-Large Short/Regular

Inseam: to 32 1/2 In
 Waist: Over 39 in
 NSN: 8415-01-228-1331
 NATO Size: 6783/9909

X-Large Long

Inseam. Over 32 1/2 in
 Waist: Over 39 in
 NSN: 8415-01-228-1332
 NATO Size: 8390/9909

Table 20-20. Undershirt Sizes

X-Small

Chest: Under 33
 NSN: 8415-01-227-9547
 NATO Size: 7080/7484

Small

Chest: 33 to 37 in
 NSN: 8415-01-227-9548
 NATO Size: 7080/8494

Medium

Chest: 37 to 41
 NSN: 8415-01-227-9549
 NATO Size: 7080/9404

Large

Chest: 41 to 45
 NSN: 8415-01-227-9550
 NATO Size: 7080/0414

X-Large

Chest: 45 in and up
 NSN: 8415-01-227-9551
 NATO Size: 7080/1424

20-8. RESIZING - Continued

Table 20-21. Drawer Sizes

X-Small

Waist: Below 27 in
 NSN: 8415-01-227-9542
 NATO Size: 7583/5869

Small

Waist: From 27 to 31 in
 NSN: 8415-01-227-9543
 NATO Size: 7583/6979

Medium

Waist: From 31 to 35 in
 NSN: 8415-01-227-9544
 NATO Size: 7583/7989

Large

Waist: From 35 to 39 in
 NSN: 8415-01-227-9545
 NATO Size: 7583/8999

X-Large

Waist: From 39 to 43 in
 NSN: 8415-01-227-9546
 NATO Size: 7583/9909

Table 20-21.1. Ruff Sizes

X-Small

Fits all lengths of X-Small Parka
 NSN: 8415-01-315-9765
 NATO Size: 7080/7484

Small

Fits all lengths of Small Parka
 NSN: 8415-01-315-9766
 NATO Size: 7080/8494

Medium

Fits all lengths of Medium Parka
 NSN: 8415-01-315-9767
 NATO Size: 7080/8494

Large

Fits all lengths of Large Parka
 NSN: 8415-01-315-9768
 NATO Size: 7080/0414

X-Large

Fits all lengths of X-Large Parka
 NSN: 8415-01-315-9769
 NATO Size: 7080/1424

20-9. WORKMANSHIP

All work shall be accomplished only by qualified personnel. The finished garments shall be complete, clean and free from defects affecting their serviceability and appearance. Sealed seams and stitchings shall show no leakage when tested. Threads shall be neatly trimmed. Drawcords shall not be missing or caught in hem, tunnel, or waistband stitching. Drawcords shall be of sufficient lengths with ends heat seared and knotted. Slide fasteners shall close properly, be of specified length and color, and contain thongs as specified. Seams shall not be twisted, pleated, or puckered. Stitch tension shall be adequate, not loose or tight, with specified number of stitches per inch on major portions of seam. The material shall not be defective or damaged in any manner. The material shall not contain cuts, tears, mends, burns, needle chews or holes.

20-10. INSPECTION

The inspection or quality control unit is responsible for determining compliance with repair instructions and requirements for classification. In-process inspections shall be performed for quality of workmanship and correct application of repair procedures. The completed item will be inspected for serviceable condition and appearance to ensure against return of substandard products to supply channels.

Section III. MATERIALS

FIG NO.	ITEM NO.	SM&R CODE	NSN	DESCRIPTION	UNIT OF ISSUE
20-1	1	PAFZZ		PARKA, EXTENDED COLD WEATHER, CAMOUFLAGE (Figure 201 and Figure 202) Barrel Lock; black, ITW Nexus Barroloc, Part No. (BBL) Black Delrin (FSCM 02768) Source: ITW 230 Gerry Dr. Wood Dale, IL 60191	EA
20-1	2	PAFZZ		Tape, Textile, Nylon Woven; olive drab 7, 1/2 inch wide, conforming to MIL-T-2283 Source: Bally Ribbon Mills 23 N. Seventh St. Bally, P.A. 19503	YD
20-1	2	PAFZZ		Tape, Textile, Nylon Woven; black, 1/2 inch wide, conforming to MIL-T-2283. Source: Bally Ribbon Mills 23 N. Seventh St. Bally, P.A. 19503	YD
20-1	3	XBFZZ		Label: For Clothing Equipage and Tentage (General Use) class 1 identification label Class 2 size label and class 3 instruction label medium green, C.A. 70034, 70130, or 70131 conforming to type VI of DDD-L 20. Source E.I. DuPont de Nemours and Co. Inc. Textile Fiber Department Wilmington, Delaware 19898	
20-1	4	XBFZZ		Tape, Seam sealing; 1 _1/16 inch wide strips, olive green 106 laminated cloth fabricated in layers as follows: Nylon 6.6 tricot weighing 1.5 ±0.3 oz/yd.2 The middle layer of microporous expanded polytetrafluoroethylene film weighing 0.6 + 0.2 or - 0.1 oz/yd.2 Adhesive thermoplastic not less than 5.4 mils thick. Source: W. L. Gore Assoc. 3 Blue ball Rd Elkton, MD 21921. Part Number: HIK 016 GT	YD

Section III. MATERIALS - Continued

FIG NO.	ITEM NO.	SM&R CODE	NSN	DESCRIPTION	UNIT OF ISSUE																								
20-1	5	PAFZZ		<p>PARKA, EXTENDED COLD WEATHER CAMOUFLAGE (Figure 20-1 and Figure 20-2) -Continued</p> <p>Fastener, Slide, Underarm type 1, style 6, size MS black, black tape, nylon or polyester continuous coil or ladder type configuration conforming to V-F-106. Lengths corresponding to the parka size indicated below: (See size code legend at end of Section III)</p> <p>Source: See page 20-38</p> <table> <tr> <td>Size</td> <td>inch</td> <td>cm</td> </tr> <tr> <td>XS</td> <td>26 7/8</td> <td>68.25</td> </tr> <tr> <td>S</td> <td>26 3/8</td> <td>69.50</td> </tr> <tr> <td>M</td> <td>27 3/8</td> <td>70.75</td> </tr> <tr> <td>L</td> <td>27 7/8</td> <td>72.10</td> </tr> <tr> <td>XL</td> <td>28 7/8</td> <td>73.35</td> </tr> </table>	Size	inch	cm	XS	26 7/8	68.25	S	26 3/8	69.50	M	27 3/8	70.75	L	27 7/8	72.10	XL	28 7/8	73.35							
Size	inch	cm																											
XS	26 7/8	68.25																											
S	26 3/8	69.50																											
M	27 3/8	70.75																											
L	27 7/8	72.10																											
XL	28 7/8	73.35																											
20-1	6	PAFZZ	8315-00-253-6288	Tape, Textile, Cotton General Purpose; throng pulls, olive drab 7, 1/2 inch conforming to MIL-T-2283.	YD																								
20-1	6	PAFZZ		Tape, Textile, Cotton General Purpose; throng pulls, olive drab 7, 1/2 inch conforming to MIL-T-2283.	YD																								
20-1	7	PAFZZ	8315-00-448-5663	Fastener Tape, Hook, Nylon Synthetic; olive green 1061 1/2 inch wide, type II, class 1 of MIL-F-21840	YD																								
20-1	8	PAFZZ	8315-01-243-3193	Fastener Tape, Pile, Nylon Synthetic; olive green 10611 1/2 inch wide, type II, class 1 of MIL-F-21840	YD																								
20-2	1	XBFZZ	8305-01-243-3193	Cloth, Laminated; waterproof and moisture-vapor permeable. 56 inch wide conforming to MIL-C-44187 Source: W.L. Gore Assoc. 3 Blueball Rd. Elkton, MD 21921	YD																								
20-2	2	PAFZZ		<p>Fastener, Slide, Front Entry; type IV, style 8 Size MH, black tape individual element molded black plastic with two sliders enabling two-way opening conforming to V-F-106. Lengths corresponding to the parka sizes indicated below: (See size code legend at end of Section III)</p> <p>Source: See page 20-38</p> <table> <tr> <td>Size</td> <td>inch</td> <td>cm</td> </tr> <tr> <td>XSXS</td> <td>26 7/8</td> <td>67.60</td> </tr> <tr> <td>XSS</td> <td>27 5/8</td> <td>70.10</td> </tr> <tr> <td>XSR</td> <td>29 1/8</td> <td>74</td> </tr> <tr> <td>XSL</td> <td>30 5/8</td> <td>77.75</td> </tr> <tr> <td>SXS</td> <td>27 1/8</td> <td>68.85</td> </tr> <tr> <td>SS</td> <td>28 1/8</td> <td>71.40</td> </tr> <tr> <td>SR</td> <td>29 5/8</td> <td>75.25</td> </tr> </table>	Size	inch	cm	XSXS	26 7/8	67.60	XSS	27 5/8	70.10	XSR	29 1/8	74	XSL	30 5/8	77.75	SXS	27 1/8	68.85	SS	28 1/8	71.40	SR	29 5/8	75.25	YD
Size	inch	cm																											
XSXS	26 7/8	67.60																											
XSS	27 5/8	70.10																											
XSR	29 1/8	74																											
XSL	30 5/8	77.75																											
SXS	27 1/8	68.85																											
SS	28 1/8	71.40																											
SR	29 5/8	75.25																											

Section III. MATERIALS - Continued

FIG NO.	ITEM NO.	SM&R CODE	NSN	DESCRIPTION	UNIT OF ISSUE
				PARKA, EXTENDED COLD WEATHER CAMOUFLAGE (Figure 20-1 and Figure 20-2) -Continued Size inch cm SL 31 1/8 79 MXS 27 5/8 70.25 MS 28 5/8 72.65 MR 30 1/8 76.50 ML 31 5/8 80.35 LS 29 1/8 74 LR 30 5/8 77.75 LL 32 1/8 81.50 XLR 31 1/8 79 XLL 32 5/8 82.85	
20-2	3	XBFZZ		Cloth, Plain Weave, polyester cotton, olive green 106, minimum 45 inch wide conforming to MIL-C-44157 Source: Sitex Inc. 215 W. 40 th Street New York, NY 10018	YD
20-2	4	PAFZZ		Cloth, Taffeta, Nylon, olive green 106, minimum 45 inch wide, conforming to type III of MIL-C-21852. (FSCM 81349) Source: H. Landau 210 Conshohoken Road Bala Cynwyd, PA 19004	YD
20-2	5	PAFZZ	8305-00-965-4816	Webbing, Textile (Cotton Elastic) 7/8 inch unbleached cotton, type, class 5, conforming to JJ-W-155	
20-2	6	PAFZZ	5325-00-292-5300 (stud) 5325-01-016-8349 (eyelet)	Fastener, Snap; stud and post parts style 2A finish 2, consisting of stud and eyelet size 1 or 2 conforming to MIL-F-10884	
20-2	7	PAFZZ		Cord, Elastic, Nylon 3/16 inch diameter, rubber elastic (multi strand) w/braided nylon covering olive drab 107, conforming to type II of MIL-C-43701 Length in accordance with Table 20-5. Source: Hope Webbing Co. PO Box 6387 Providence, R.I. 02940	YD
20-2	8	PAFZZ	8315-01-010-7203	Fastener Tape, Hook, Nylon Synthetic, olive green 106 type II, class 1 of MIL-F-21840, 5/8 inch wide	YD

Section III. MATERIALS - Continued

FIG NO.	ITEM NO.	SM&R CODE	NSN	DESCRIPTION	UNIT OF ISSUE
20-2	9	PAFZZ	8315-01-010-7204	PARKA, EXTENDED COLD WEATHER CAMOUFLAGE (Figure 20-1 and Figure 20-2) -Continued Fastener Tape, Pile, Nylon Synthetic, olive green 106 type II, class of MIL-F-21840, 5/8 inch wide	YD
20-2	10	PAFZZ	8315-00-988-1299	Thread Polyester, size B 2 or 3 ply, shade S-1, C.A. 66022 type 1, class 1 subclass B, conforming to V-T-285	CN
20-2	11	PAFZZ	8315-00-151-6480	Fastener Tape, Hook, Nylon Synthetic; olive green 106 1 inch wide, type 1, class 1 of MIL-F-21840	
20-2	12	PAFZZ	8315-00-151-6484	Fastener Tape, Pile, Nylon Synthetic; olive green 106 1 inch wide, type 1, class 1 of MIL-F-21840	
20-3	1	PAFZZ		TROUSERS, EXTENDED COLD WEATHER, CAMOUFLAGE (Figure 20-3 and Figure 20-4) Barrel Lock: black ITW Nexus Barreloc, or equiv. PN (BBL) Black Delrin Source: ITW 230 Gerry Dr. Wood Dale, IL 60191 (FSCM 02768)	EA
20-3	2	PAFZZ		Cord, Elastic, Nylon 3/16 inch diameter rubber elastic (multi-strand) w/braided nylon covering, olive drab 107, conforming to type II of MIL-C-43701 Length in accordance with Table 20-7 Source: Hope Webbing Co. PO Box 6387 Providence, R.I. 02940	YD
20-3	3	PAFZZ		Fastener, Slide, Interlocking; black type I style 3, size MS, nylon or polyester continuous coil or ladder configuration, with thong. Black tape 17 inches, (43.30 cm) conforming to V-F-106 Source: See page 20-38	EA
20-3	4	PAFZZ		Fastener, Tape, Hook nylon synthetic, olive green 106, type II, 1 1/2 inch wide, class of MIL-F-21840	YD

Section III. MATERIALS - Continued

FIG NO.	ITEM NO.	SM&R CODE	NSN	DESCRIPTION	UNIT OF ISSUE																											
20-3	5	PAFZZ	8315-00-448-5664	TROUSERS, EXTENDED COLD WEATHER CAMOUFLAGE (Figure 20-3 and Figure 20-4) Fastener Tape, Pile nylon synthetic, olive green 106, type II 1 1/2 wide, class of MIL-F-21840	YD																											
20-3	6	PAFZZ	8305-00-243-3193	Cloth, Laminated; waterproof and moisture-vapor permeable. 56 inch wide conforming to MIL-C-44187 Source: W.L. Gore Assoc. 3 Blueball Rd., Elkton, MD 21921																												
20-4	1	PAFZZ		Tape, Textile, Nylon Woven; olive drab 7 conforming to MIL-T-2283 Source: Bally Ribbon Mills 23 N. Seventh St. Bally, P.A. 19503	YD																											
20-4	2	XBFZZ		Label: for Clothing Equipage and tentage (General Use) identification, size, and instruction label, khaki, C.A. 70188 conforming to type VI of DDD-L-20. Source: E.I. DuPont de Nemours and Co., Inc. Textile Fiber Department Wilmington, Delaware 19898	EA																											
20-4	3	PAFZZ	5325-00-292-5300 (stud) 5325-01-016-8349 (eyelet)	Fastener, Snap, stud and post parts, style 2A, finish 2, consisting of stud and eyelet size 1 or 2, conforming to MIL-F-10884	EA																											
20-4	4	PAFZZ		Fastener Slide interlocking; black type 1 style 3, size MS, nylon or polyester continuous coil or ladder configuration, with thong, black tape, conforming to V-F-106 Lengths corresponding to the trouser sizes indicated below: (See size code legend at the end of Section III) Source: See page 20-38 <table style="margin-left: 40px;"> <thead> <tr> <th>Size</th> <th>inch</th> <th>cm</th> </tr> </thead> <tbody> <tr> <td>XSXS</td> <td>6 1/2</td> <td>16.50</td> </tr> <tr> <td>XSS</td> <td>7</td> <td>17.75</td> </tr> <tr> <td>XSR</td> <td>7 1/2</td> <td>19</td> </tr> <tr> <td>XSL</td> <td>8</td> <td>20.35</td> </tr> <tr> <td>SXS</td> <td>7</td> <td>17.75</td> </tr> <tr> <td>SS</td> <td>7 1/2</td> <td>19</td> </tr> <tr> <td>SR</td> <td>8</td> <td>20.35</td> </tr> <tr> <td>SL</td> <td>8 1/2</td> <td>21.60</td> </tr> </tbody> </table>	Size	inch	cm	XSXS	6 1/2	16.50	XSS	7	17.75	XSR	7 1/2	19	XSL	8	20.35	SXS	7	17.75	SS	7 1/2	19	SR	8	20.35	SL	8 1/2	21.60	EA
Size	inch	cm																														
XSXS	6 1/2	16.50																														
XSS	7	17.75																														
XSR	7 1/2	19																														
XSL	8	20.35																														
SXS	7	17.75																														
SS	7 1/2	19																														
SR	8	20.35																														
SL	8 1/2	21.60																														

Section III. MATERIALS - Continued

FIG NO.	ITEM NO.	SM&R CODE	NSN	DESCRIPTION	UNIT OF ISSUE
				TROUSERS, EXTENDED COLD WEATHER CAMOUFLAGE (Figure 20-3 and Figure 20-4) MXS 7 1/2 19 MS 8 20.35 MR 8 1/2 21.60 ML 9 22.85 LXS 8 20.35 LS 8 1/2 21.60 LR 9 22.85 LL 9 1/2 24.10 XLXS 8 1/2 21.60 XLS 9 22.85 XLR 9 1/2 24.10 XLL 10 25.40	
20-4	5	PAFZZ	8310-01-063-9282	Thread, Polyester, brown C.A. 66022, conforming to type I, class 1, size B, subclass B, of V-T-285	CN
20-4.1	1	F	8320-01-147-2086	LINER, COLD WEATHER COAT (Figure 20-4.1) Batting, Quilted Polyester, Type VIII, Cover A, Style A, Class 9 of MIL-B-41826 Source of supply for repair: Canabalize from old items.	
20-4.1	2	PAFZZ	8305-00-261-8140	Cloth, Oxford, Nylon, Olive Green shade 106, MIL-C-508, for facing and binding	YD
20-4.1	3	PAFZZ	8310-00-244-0603	Thread, Nylon, Olive Drab Shade 66022 (S-1), 3 Ply, Ticket A, A-A-50199	TU
20-4.1	3	PAFZZ	8310-00-244-0602	Thread, Nylon, Olive Drab Shade 66022 (S-1), 2 Ply Ticket B, A-A-50199	SL
20-4.1	3	PAFZZ	8310-00-262-0096	Thread, Cotton Gimp, Olive Drab Shade 66022 (S-1), A-A-50198	SL
20-4.1	4	PAFZZ	8315-00-899-0029	Button, Sewing Hole, Olive Green Shade 62016 (BP) Style 26, B-B-871	GR
20-4.1	5	PAOZZ	8315-00-255-7675	Tape, Pressure Sensitive Adhesive, for Mending Nylon Parachutes, Type I, 1 inch MIL-T-6134 (81349), MIL-T-43618. Source of Supply: Fasson Products Painesville, Ohio	

Section III. MATERIALS - Continued

FIG NO.	ITEM NO.	SM&R CODE	NSN	DESCRIPTION	UNIT OF ISSUE
20-4.2	1	F	8320-01-147-2086	LINER, COLD WEATHER TROUSERS (Figure 20-4.2) Batting, Quilted Polyester, Type VIII, Cover A, Style A, Class 9 of MIL-B-41826 Source of supply for repair: Canabalize from old items.	
20-4.2	2	PAFZZ	8305-00-261-8140	Cloth, Oxford, Nylon, Olive Green Shade 106, MIL-C-508, for facing and binding	YD
20-4.2	3	PAFZZ	8310-00-244-0603	Thread, Nylon, Olive Drab Shade 66022 (S-1), 3 Ply, Ticket A, A-A-50199	TU
20-4.2	3	PAFZZ	8310-00-244-0602	Thread, Nylon, Olive Drab Shade 66022 (S-1), 2 Ply, Ticket B, A-A-50199	SL
20-4.2	3	PAFZZ	8310-00-262-0096	Thread, Cotton Gimp, Olive Drab Shade 66022 (S-1), 3 Ply, Ticket 8, A-A-50198	SL
20-4.2	4	PAFZZ	8315-00-899-0029	Button, Sewing Hole, Olive Green Shade 62016 (BP) Style 26, V-B-871	GR
20-4.2	5	PAOZZ	8315-00-255-7675	Tape, Pressure Sensitive Adhesive, for Mending Nylon Parachutes, Type I, 1 inch, MIL-T-6134 (81349), MIL-T-43618. Source of Supply: Fasson Products Painesville, Ohio	
20-5	1	XBFZZ		SHIRT COLD WEATHER, POLYESTER FIBERPILE (Figure 20-5) Cloth, Plain Weave, Polyester/Cotton black, 464, minimum 60 inch wide conforming to MIL-C-44162 Source: Reeves Brothers 1271 Avenue of the Americas New York, NY 10028	YD
20-5	2	XBFZZ		Tape, Textile, Nylon, Woven, flat black, 3/8 inch conforming to MIL-T-2283 Source: Bally Ribbon Mills 23 N. Seventh St. Bally, PA 19503	YD
20-5	3	PAFZZ	8315-00-253-6288	Tape, Textile, Cotton General Purpose; thong pulls, olive drab 7, conforming to MIL-T-43566 Source: Bally Ribbon Mills 23 N. 7th Street Bally, PA 19503	EA
20-5	4	PAFZZ		Fastener, Slide, Interlocking; type IV, style 8, size M, black polyester or nylon continuous element coil or ladder configuration with long tab pull and thong. Black tape conforming to V-F-106 Lengths corresponding to the shirt sizes indicated below: (See size code legend at end of Section III)	

Section III. MATERIALS

FIG. NO.	ITEM NO.	SMR CODE	NSN	DESCRIPTION	UNIT OF ISSUE																		
20-5	5	PAFZZ		<p>SHIRT, COLD WEATHER, POLYESTER FIBERPILE (Figure 205) Source: See page 20-38</p> <table border="0"> <tr> <td>Size</td> <td>Inch</td> <td>cm</td> </tr> <tr> <td>XS</td> <td>26 7/8</td> <td>68.25</td> </tr> <tr> <td>S</td> <td>27 3/8</td> <td>69.50</td> </tr> <tr> <td>M</td> <td>27 7/8</td> <td>70.75</td> </tr> <tr> <td>L</td> <td>28 3/8</td> <td>72.10</td> </tr> <tr> <td>XL</td> <td>28 7/8</td> <td>73.35</td> </tr> </table> <p>Barrel Lock; black, ITW Nexus Barreloc, or equiv. PN (BBL) Black Deirin Source: ITW 230 Gerry Dr. Wood Dale, IL 60191 (FSCM 02768)</p>	Size	Inch	cm	XS	26 7/8	68.25	S	27 3/8	69.50	M	27 7/8	70.75	L	28 3/8	72.10	XL	28 7/8	73.35	EA
Size	Inch	cm																					
XS	26 7/8	68.25																					
S	27 3/8	69.50																					
M	27 7/8	70.75																					
L	28 3/8	72.10																					
XL	28 7/8	73.35																					
20-5	6	PAFZZ		<p>Cord, Elastic, Nylon 3/16 inch diameter, rubber elastic (multi-strand) w/braided nylon covering olive drab 107, conforming to type II of MIL-C-43701 Length according to Table 20-8. Source: Hope Webbing Co. PO Box 6387 Providence, R.I. 02940</p>	YD																		
20-5	7	PAFZZ	5325-01-139-4839	<p>Eyelet, Metallic and Eyelet Washers, Metallic conforming to M20652/1 -BBE125 of MIL-E-20625</p>	EA																		
20-5	8	PAFZZ	8315-00-935-6762	<p>Fastener, Tape, Hook Synthetic, Black, type I class 2, conforming to MIL-F-21840, 5/8 inch</p>	YD																		
20-5	9	PAFZZ	8315-00-935-6763	<p>Fastener, Tape, Pile Synthetic, black, type I class 2, conforming to MIL-F-21840, 5/8 inch</p>	YD																		
20-5	10	PAFZZ	8310-00-988-1299	<p>Thread, Polyester, size B 2 or 3 ply, shades S-1 C.A. 66022, conforming to type I, class 1, sub-class B, of V-T-285</p>	CN																		
20-5	11	XBFZZ		<p>Cloth, Pile, Synthetic, Fiberpil; brown 463 class 4, minimum 60 inch wide conforming to MIL-C-43251 Source: Borg Textile Corp. P.O. Box 657 Rossville, GA. 30741</p>	YD																		

Section III. MATERIALS

FIG. NO.	ITEM NO.	SMR CODE	NSN	DESCRIPTION	UNIT OF ISSUE
20-6	1	XBFZ		OVERALL, BIB COLD WEATHER FIBERPILE (Figure 20-6) Tape, Textile, Nylon Woven, flat black, 1/2 inch wide, conforming to MIL-T-2283 Source: Bally Ribbon Mills 23 N. 7th Street, Bally, PA 19503	YD
20-6	2	PAFZZ		Fastener, Suspender; black, 2 inches, quick release model, ITW Nexus SF, PN SF/2" 5050 or equivalent. (FSCM 02768) Source: ITW 230 Gerry Or. Wood Dale, IL 60191	YD
20-6	3	PAFZZ	8310-01-063-9282	Thread, Polyester, brown C.A. 66069, conforming to type I, class 1, subclass A, size B or V-T-285	CN
20-6	4	PAFZZ		Fastener, Slide, Interlocking: type 1, style 19 size MS, black, nylon or polyester continuous coil or ladder, length 22 1/2 inch (57.20 cm) black type conforming to V-F-106 Source: See page 20-38	EA
20-6	5	XBFZZ		Cloth, Pile, Synthetic Fiberpile; brown 463 class 4, minimum width 60 inches, conforming to MIL-C-43251 Source: Borg Textile Corp P.O. Box 697 Rossville, GA 30741	YD
20-6	6	PAFZZ		Webbing, Textile, Woven Nylon; 1 1/4 inches wide black, type III, class 2 conforming to MIL-W-4088 Source: Narricot Webbing P.O. Box 57 Cheltenham, PA 19012	YD
20-6	7	PAFZZ		Fastener, Slide, interlocking; type IV, style 8 size MS, individual element molded plastic black with black thong equipped with two single pull sliders mouth to mouth arrangement, enabling two-way opening. Length 39 1/2 inch (100.35 cm) conforming to V-F-106 Source: See page 20-38	EA
20-6	8	PAFZZ	8305-01-015-9434	Webbing, Textile, Woven Nylon; 1 23/32 inch wide black, type VIII, class 2	YD

Section III. MATERIALS

FIG. NO.	ITEM NO.	SMR CODE	NSN	DESCRIPTION	UNIT OF ISSUE
20-6	9	XBFZZ		<p>OVERALL, BIB, COLD WEATHER FIBERPILE (Figure 20-6) Label: For Clothing Equipage and Tentage (General Use) Identification, size, and instruction label, khaki, C.A. 70188 conforming to type VI of DDD-L-20 Source: E.I. DuPont de Nemours and Co., Inc. Textile Fiber Department Wilmington, Delaware 19898</p>	EA
20-6	10	PAFZZ		<p>Suspenders, Spandex finish Knit elastic, 2 inch wide black Source: South Carolina Elastic Company Part #15034-k-1</p>	EA
20-7	1	XBFZZ		<p>DRAWERS, COLD WEATHER, POLYPROPYLENE (Figure 207) Cloth Knitted, Terry Polypropylene Source: PKM Incorporated 509 Glenbrook Rd. Stamford, CT 06906</p>	YD
20-7	2	XBFZZ		<p>Cuff Material. The cloth for the cuffs shall be from a 14 odenier (nominal) multifilament 100% Polypropylene yarn. Source: PKM Incorporated Stamford, CT 06906</p>	
20-8	1	XBFZZ		<p>UNDERSHIRT, COLD WEATHER, POLYPROPYLENE (Figure 20-8) Cloth, Knitted, Terry Polypropylene Source: PKM Incorporated 509 Glenbrook Rd. Stamford, CT 06906</p>	YD
20-8	2	PAFZZ		<p>Fastener Slide. The slide fastener shall be a continuous element coil or ladder configuration and conform to Type I, Style 3, size LS of VF-106. The color of the slide fastener shall approximate the color of the undershirt.</p>	SPOOL

Section III. MATERIALS

FIG. NO.	ITEM NO.	SMR CODE	NSN	DESCRIPTION	UNIT OF ISSUE
20-8.1	1	XBFZZ		<p>RUFF, PARKA, EXTENDED COLD WEATHER (Figure 20-8.1) Label: For Clothing, Equipage, and Tentage General Purpose, Class 3 Instruction Label and Class 4 Identification and Size Label. Type VI of DDD-L-20, Medium Green, C.A. 70034, 70130 or 70131 with fastness to laundering. As an alternative, a combination size and identification label conforming to Class 14 of DDD-L-20. Source of Supply: E.I. DuPont de Nemours and Co. Inc. Textile Fiber Department Wilmington, DE 19898</p>	EA
20-8.1	2	PAFZZ	8315-00-988-1299	<p>Thread, Polyester, Size B, 2 or 3 ply, Shade 8-1, C.A. 66022, type I, class 1, subclass B of V-T-285</p>	CN
20-8.1	3	PAFZZ	8315-01-090-5096	<p>Fastener Tape, 1 inch hook conforming to type II, class 1 of MIL-F-21840, Olive Green 106</p>	RL
20-8.1	4	PAFZZ	8315-01-086-9635	<p>(H) Fastener Tape, 2 inch hook and pile respectively conforming to type II, class 1 of (P) MIL-F-21840, Olive Green 106</p>	RL
20-8.1	5	PAFZZ	8315-00-498-6631 5325-00-292-5300	<p>Snap Fastener, Stud and Post (Male) conforming to style 2A, finish 2, MIL-F-10884 Copper Wire, Non-insulated 0.08 i 0.003 inch diameter (12 gauge) dead soft and bright Source of Supply: Electric Specialty and Supply Roxbury, MA (617) 442-6400</p>	EA
20-8.1	6	XBFZZ	8305-01-243-3193	<p>Cloth, Laminated, Waterproof and Moisture-Vapor Permeable conforming to MIL-C-44187 Source of supply: W.L. Goeit Associates 3 Blueball Rd Elkton, MD 21921</p>	YD
20-8.1	7	XBFZZ		<p>Cloth, Synthetic Fur, Knitted, conforming to MIL-C-43824 Source of Supply: Bora Textiles Corp 105 Maple St Rossville, GA 30741</p>	

Section III. MATERIALS

GARMENT SIZE CODE LEGEND:

XSXS	X-SMALL X-SHORT	MS	MEDIUM SHORT
XSS	X-SMALL SHORT	M	MEDIUM
XS	X-SMALL	MR	MEDIUM REGULAR
XSR	X-SMALL REGULAR	ML	MEDIUM LONG
XSL	X-SMALL LONG	LS	LARGE SHORT
SXS	SMALL X-SHORT	L	LARGE
SS	SMALL SHORT	LR	LARGE REGULAR
S	SMALL	LL	LARGE LONG
SR	SMALL REGULAR	XL	X-LARGE
SL	SMALL LONG	XLR	X-LARGE REGULAR
MXS	MEDIUM X-SHORT	XLL	X-LARGE LONG

SLIDE FASTENER SOURCE:

YKK (U.S.A.) Inc.
 7 Nescaminy Interplex
 Suite 209
 Trevose, PA 19047

CHAPTER 21

MAINTENANCE OF WOMAN'S MATERNITY WORK UNIFORMS

Section I. INTRODUCTION

21.1 SCOPE

This chapter provides Instructions that cover the materials, methods and procedures for repair and maintenance of the maternity coat and slacks.

21.2 COMMODITY SPECIFICATION

a. Items

SPECIFICATION	ITEM
MI L-C-44111	Coat, Woman's, Maternity Work Uniform
MIL-C-44110	Slacks, Woman's Maternity Work Uniform

b Components

SPECIFICATION	ITEM
V-B-871	Button, Sewing Hole, and Button Staple (Plastic)
V-T-276	Thread, Cotton
V-T-280	Thread, Gimp, Cotton, Buttonhole
MIL-C-43468	Cloth, Camouflage Pattern, Wind Resistant
	Poplin, Cotton
MIL-T-43548	Thread, Polyester, Cotton-Covered

21-3. IDENTIFICATION AND DESCRIPTION

1. Coat/Slacks, Camouflage Pattern.

a. Coat. Camouflage Pattern, is fabricated of wind resistant, poplin, cotton. It is a single breasted coat style design with collar, two patch pockets with flaps, straight cut bottom, adjustable cuff tabs and side body panels with tabs. The coat back is cut from one piece of material. The front is secured by buttons and buttonholes concealed by a flay on the left front. The pockets are also closed by buttons and buttonholes. All major joining seams are of a double-lapped and double-stitched construction (See figure 21-1).

b. Slacks. Camouflage pattern, is fabricated of wind resistant, popling, cotton. The slacks have an elasticized waistband, a front stretch panel and two side pockets with flaps that are closed with buttons and buttonholes. All major joining seams are of a double-lapped and double stitched construction (See figure 21-2).

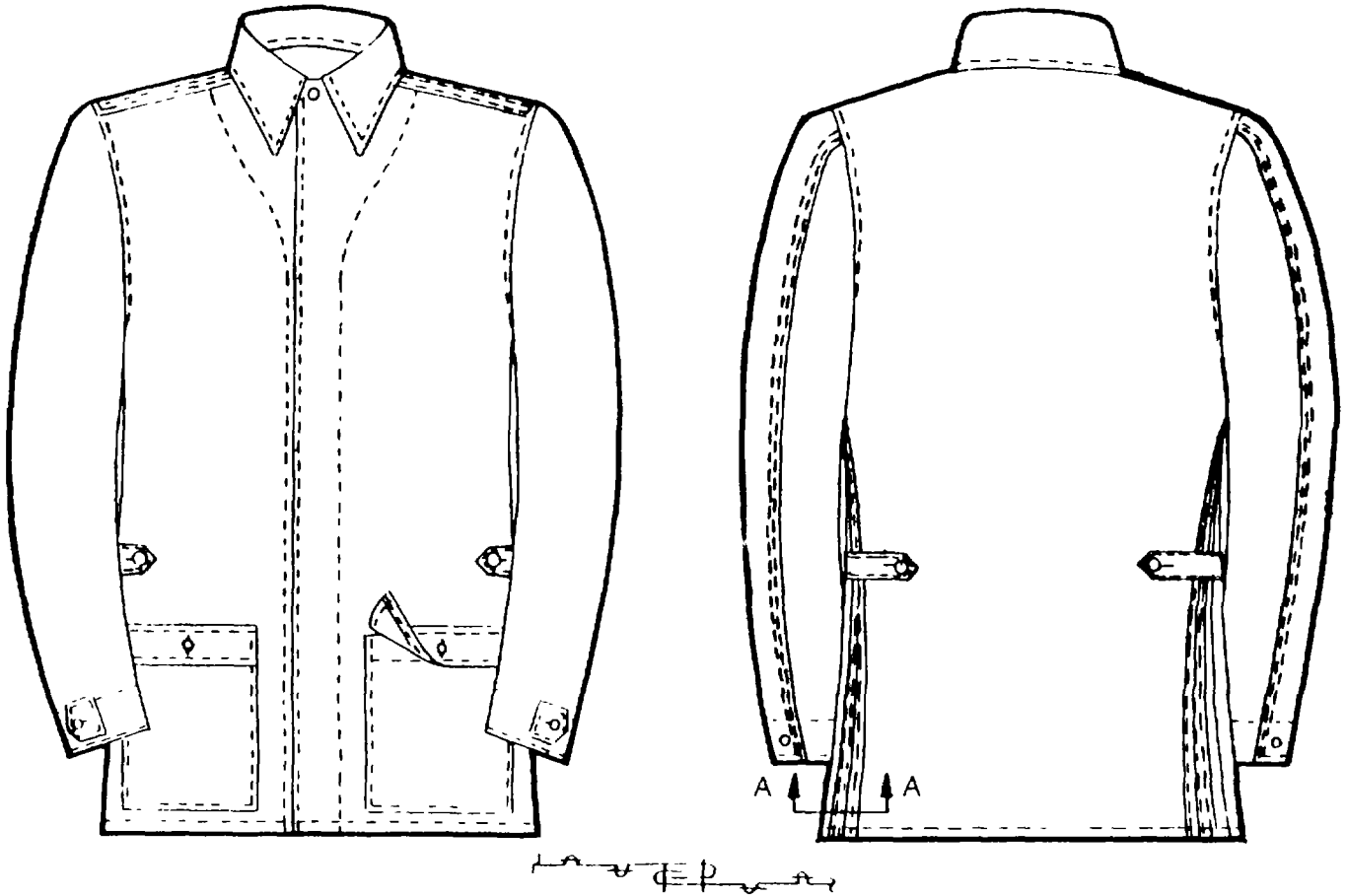

SECTION A-A

Figure 21-1. Coat Woman's, Maternity Work Uniform.

21-3. IDENTIFICATION AND DESCRIPTION-Continued

Table 20-1. Coat, Woman's, Maternity Work Uniform

NSN	SHORT	1/2 1 CHEST	1/2 2 SWEEP	CROSS 3 BACK	BACK 4 LENGTH	SLEEVE 5 LENGTH	6 COLLAR
	Tolerance 1/2"	T-1/2"	T-1/2"	T-1/2"	T-1/2"	T-1/2"	T-1/4"
8410-01-170- 7522 7525 7528 7531 7534 7537 7540	6	19-1/2	24-1/4	15	27-1/4	22	15-1/8
	8	20	24-3/4	15-3/8	27-1/2	22-1/4	15-1/2
	10	20-1/2	25-1/4	15-3/4	27-3/4	22-1/2	15-7/8
	12	21-1/4	26	16-1/8	28	22-3/4	16-1/4
	14	22	26-3/4	16-1/2	28-1/4	23	16-5/8
	16	22-3/4	27-1/2	16-7/8	28-1/2	23-1/4	17
	18	23-3/4	28-1/2	17-1/4	28-3/4	23-1/2	17-3/8
	20	24-3/4	29-1/2	17-5/8	29	23-3/4	17-3/4
8410-01-201- 4204 4207	22	25-3/4	30-1/2	18	29-1/4	24	18-1/8
	REG.						
8410-01-170- 7523 7526 7529 7523 7535 7538 7541	6	19-1/2	24-1/4	15	28-3/4	23	15-1/8
	8	20	24-3/4	15-3/8	29	23-1/4	15-1/2
	10	20-1/2	25-1/4	15-3/4	29-1/4	23-1/2	15-7/8
	12	21-1/4	26	16-1/8	29-1/2	23-3/4	16-1/4
	14	22	26-3/4	16-1/2	29-3/4	24	16-5/8
	16	22-3/4	27-1/2	16-7/8	30	24-1/4	17
	18	23-3/4	28-1/2	17-1/4	30-1/4	24-1/2	17-3/8
	20	24-3/4	29-1/2	17-5/8	30-1/2	24-3/4	17-3/4
8410-01-201- 4205 4208	22	25-3/4	30-1/2	18	30-3/4	25	18-1/8
	LONG						
8410-01-170- 7524 7527 7530 7533 7536 7539 7542	6	19-1/2	24-1/4	15	30-1/4	24	15-1/8
	8	20	24-3/4	15-3/8	30-1/2	24-1/4	15-1/2
	10	20-1/2	25-1/4	15-3/4	30-3/4	24-1/2	15-7/8
	12	21-1/4	26	16-1/8	31	24-3/4	16-1/4
	14	22	26-3/4	16-1/2	31-1/4	25	16-5/8
	16	22-3/4	27-1/2	16-7/8	31-1/2	25-1/4	17
	18	23-3/4	28-1/2	17-1/4	31-3/4	25-1/2	17-3/8
	20	24-3/4	29-1/2	17-5/8	32	25-3/4	17-3/4
8410-01-201- 4206 4209	22	25-3/4	30-1/2	18	32-1/4	26	18-1/8

¹ 1/2 chest measurement taken from folded edge to folded edge at base of armhole.

² 1/2 sweep measurement taken from folded edge to folded edge along bottom of coat with side pleats closed.

³ Cross back measurement taken across back from back seams of sleeves.

⁴ Back length measurement taken from base of undercollar to bottom of coat.

⁵ Sleeve length measurement taken from top sleeve at shoulder seam to bottom of sleeve.

⁶ Collar measurement taken along collar joining seam.

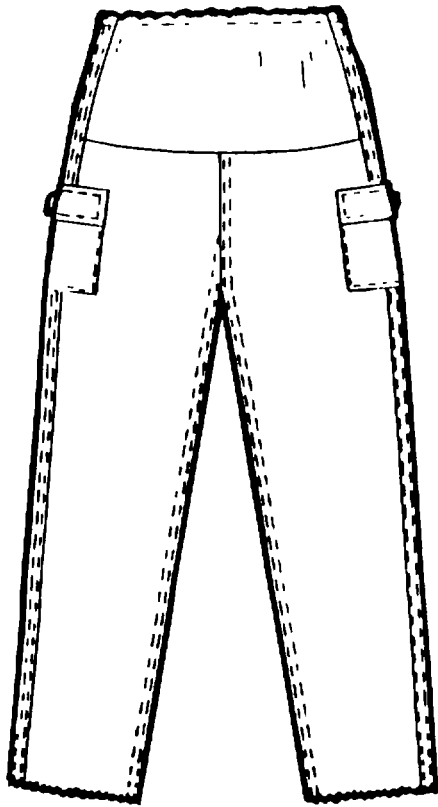

FRONT

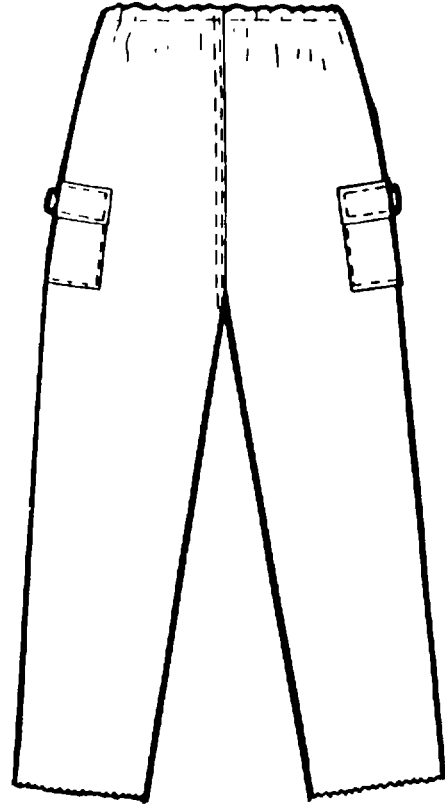

BACK

Figure 21-2. Slacks, Woman's, Maternity Work Uniform.

21-3. IDENTIFICATION AND DESCRIPTION - Continued

Table 21-2. Slacks, Woman's, Maternity Work Uniforms

NSN	SHORT	¹ / ₂ 1 WAIST	¹ / ₂ 2 HIP	³ OUTSEAM	⁴ INSEAM		
	Tolerance	T-1/2"	T-1/2"	T-1/2"	T-3/4"		
8410-01-170- 7543	6	11-3/4	19-3/4	42-1/4	32		
7546	8	12-1/4	20-1/4	42-1/2	32		
7549	10	12-3/4	20-3/4	42-3/4	32		
7552	12	13-1/2	21-1/2	43	32		
7555	14	14-1/4	22-1/4	43-1/4	32		
7558	16	15	23	43-1/2	32		
7561	18	16	24	43-3/4	32		
8410-01-201- 4230	20	17	25	44	32		
4233	22	18	26	44-1/2	32		
	REG						
8410-01-170- 7544	6	11-3/4	19-3/4	44-1/2	33-1/2		
7547	8	12-1/4	20-1/4	44-3/4	33-1/2		
7550	10	12-3/4	20-3/4	45	33-1/2		
7553	12	13-1/2	21-1/2	45-1/4	33-1/2		
7556	14	14-1/4	22-1/4	45-1/2	33-1/2		
7559	16	15	23	45-3/4	33-1/2		
7562	18	16	24	46	33-1/2		
8410-01-201- 4231	20	17	25	46-1/4	33-1/2		
4234	22	18	26	46-1/2	33-1/2		
	LONG						
8410-01-170- 7545	6	11-3/4	19-3/4	46-1/2	35		
7548	8	12-1/4	20-1/4	46-3/4	35		
7551	10	12-3/4	20-3/4	47	35		
7554	12	13-1/2	21-1/2	47-1/4	35		
7557	14	14-1/4	22-1/4	47-1/2	35		
7560	16	15	23	47-3/4	35		
7563	18	16	24	48	35		
8410-01-201- 4232	20	17	25	48-1/4	35		
4235	22	18	26	48-1/2	35		

¹ 1/2 Waist measurement taken from folded edge to folded edge at center of waistband in relaxed position.

² 1/2 Hip measurement taken from folded edge to folded edge of slacks along bottom of stretch panel.

³ Outseam measurement taken from top of waistband along seam to bottom of slacks.

⁴ Inseam measurement taken from crotch seam along Inseam to bottom of slacks.

Section II. REPAIR PROCEDURES

21-4. MATERIALS

General materials used in the repair of the coat and trousers shall be serviceable materials recovered from similar salvaged items when authorized, or will be new materials as specified in Section III. New materials will be requisitioned from stock numbers and item description and shall conform to the appropriate specifications. When not available from stock, the materials may be purchased locally that conform as closely as possible to the standard material.

21-5. REPAIR MAINTENANCE

Prior to repair operations, each item shall be inspected by qualified personnel to determine the amount of repair necessary. The following methods shall be observed as fully as skills, facilities, funds and local conditions permit. The sequence of operations shall be determined by the repairing organizations, unless otherwise prescribed.

a. Inspection. Inspect all items to determine the amount of repairs needed and whether such repairs can be accomplished within the organization or evacuate to Direct Support level of Maintenance.

b. Repair. The following repairs will be accomplished by hand or organizational maintenance'

(1) Replace missing and damaged buttons.

(2) Iron-on patches. Rips and tears other than stress points (e.g. crotch seams, pocket seams, pocket flap seams, etc.) may be repaired by Iron-on patches. Any rip or tear closer than 3/4 Inch (1.91 cm) to any seam will be repaired by sewing.

(a) Patch size. The iron-on patch shall be cut to the size and shape that it will extend 3/4 inch (1.91) cm) in all directions beyond the tear or other damage. Patches will have rounded corners.

(b) Patching procedures for iron-on patches. When patching by hand, iron place patch to the inside of the garment. The garment may be turned inside out or the patch may be inserted within the garment, taking care that the patch is centered in the desired position. Trim heavily raveled ends with scissors. Smooth out the area to be patched so that the tear is closed or very nearly closed and so that there will be no wrinkles, folds, seams, or other protrusions under the Iron when it is applied (See figure 21-3.)

21-5. REPAIR AND MAINTENANCE-Continued

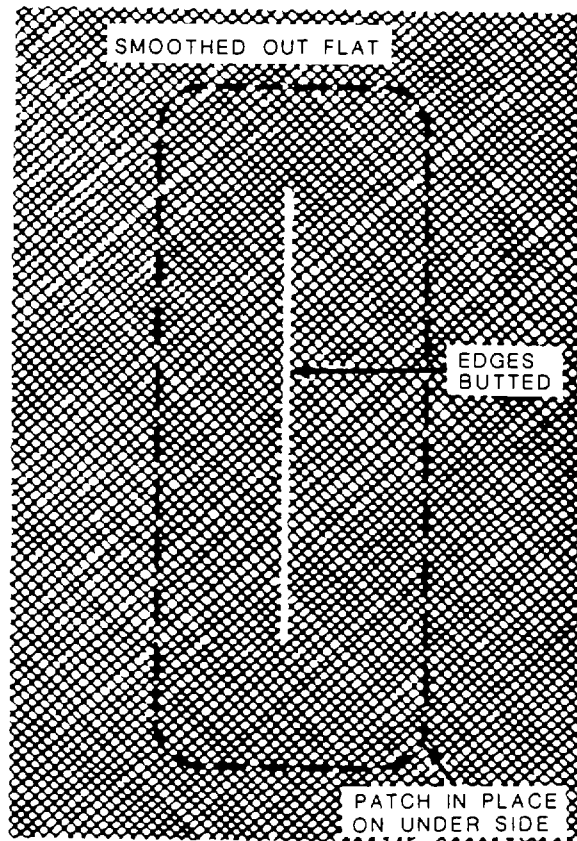

Figure 21-3. Preparing A Tear For Patching.

1. Prewarm the area to be patched by pressing with a household electric dry iron or steam Iron used dry. With Iron set at the cotton indicator or as high as possible without scorching the fabric, apply the Iron for 5 seconds or more. Immediately position the patch. Hold the iron on the patch for about 12 seconds. Use no more than a slight rotating motion of the iron and apply constant pressure. Remove the iron and allow patch area to cool. In place about 5 seconds, or long enough so that the patch will not drift off when the garment is removed from the ironing board.
2. Patches that are longer than the Iron may be ironed in sections, starting at the center and completing each section before moving to the next section. Overlapping of the iron upon previously bonded section is permissible. Carefully trim away any frayed protrusions at the torn edges.

21-5. REPAIR AND MAINTENANCE-Continued

(c) Quality control. Adjust heating, pressing and cooling times as required for the iron being used. Check the quality of the adhesive bond periodically and adjust heating times and temperatures.

NOTE

Check test. Periodically during the work and when adjusting the iron, test a patch which has cooled for about 5 minutes by picking with the fingers at the edge of the patch until a tab about 1/4 to 1/2 Inch (0.635 to 1.27 cm) long is formed. Pull hard on the tab with fingers. A well bonded tab will be difficult to peel off and will indicate that iron adjustment and heating time are adequate. Replace the check test patch with a new patch.

1. If the adhesive strikes through the patch cloth, too much heat has been applied. Reduce time of pressing or temperature of the iron. A small amount of strike through is not objectionable provided the patch meets the check test.
 2. A bonded patch which has a lifted edge will be re-ironed. A bonded patch which has been subjected to the check test will be replaced.
 3. When patching by special automatic press, the platen temperature, dwell time, dwell pressure, and other details shall be in accordance with the press manufacturer's Instructions.
- c. Cleaning. Items shall be cleaned by individual laundering or by utilizing laundry facilities provided at the installation. Follow laundering instruction on labels
- d. Direct Support Level of Maintenance
- (1) Preliminary examination and cleaning. Dirt, mud, dust, spots, mildew stain, and other foreign matter shall be removed with a brush or by laundering. Mildewy and rotten items shall be discarded. Seams shall be tested by grasping the item with both hands and pulling at right angles to the seam. Areas to be repaired shall be marked with crayon. Non-specification and personnel marks shall be erased or obscured.
 - (2) Laundry. Items shall be processed in laundry facilities in accordance with established practices set forth in FM 10-280. When such facilities are not available, items shall be laundered by contract with private industry in accordance with accepted commercial laundry practices.
 - (3) Patching. Garments may be patched by either the iron on or stitched patches.

21-5. REPAIR AND MAINTENANCE-Continued

- (4) Sewing Machine Repairs, Stitching and Restitching. All sewing, except emergency repair, shall be machine sewn. When ends of machine stitching type 301 are not caught in other seams or stitching, they shall be back-stitched not less than 1 Inch (2.54 cm) at each break. Ends of a continuous line of stitching shall overlap not less than 1/2 inch (1.27 cm). Thread breaks (all stitch types) shall be repaired by stitching back of the break not less than 1/2 Inch (1.27 cm). Thread tension shall be properly maintained to avoid loose stitching and locks shall be imbedded in the center of the material sewn. Stitch spacing used for restitching and type of seams, shall be the same as in the original construction. Seams with loose and/or weak thread shall be restitched. For illustrations of the various types of stitches used, see FED STD-751. The following types of stitch, thread size and stitches per Inch for the repair (table 21-3).

Table 21- 4.Stitching Instruction

LOCATION	STITCH TYPE	THREAD		STITCHES PER INCH
		NEEDLE	BOBBIN	
General	301	50	50	10-14
General	401	50	70	10-14
Bartacks	Bartack	50	50	28 per Bartack
Buttonholes	Buttonhole	30	50	52-56 per Buttonhole
Buttons	101 or 301	30	30	14-16 per Button

- (5) Patching and darning. Patching and darning may be applied to any area of the items. Repair small tears not more than 1/2 inch (1.27 cm) across with a darning or zigzag stitch. Patch holes with a diameter of 1/4 Inch (0.635 cm) or more. Repair rips, tears, and thin areas greater than 1/2 inch (1.27 cm) by patching. Patches shall be limited to a maximum of 2 inches (5.08 cm) in the greatest dimension. Patches shall match the garment in color and type of material. Insert patch under damaged area; cut away damaged area and turn edges under approximately 3/8 inch (0.952 cm). Cut patch large enough to extend not less than 1/2 Inch (1.27 cm) and not more than 1 inch (2.54 cm) around the perimeter of the opening with 3/8 inch (0.952 cm) turn-under of all edges except salvage edges. Precut all patches to provide for symmetry. Materials shall be those specified in Section III
- (a) Buttons. Replace missing, loose, or damaged buttons with buttons conforming to those listed in Section III. Attach the buttons securely and align with eyelet of respective buttonholes.

21-5. REPAIR AND MAINTENANCE - Continued

- (b) Buttonholes. Buttonholes shall be of the eyelet-end taper-bar type worked over gimp. Repair damaged buttonholes by reshaping enlarged buttonholes before reworking. Pull into shape and hand or machine whip a small reinforcement patch to the underside of the buttonhole. Then rework buttonhole through the patch.
 - (c) Stretch Panel. Replace damaged stretch panel with parts attained from salvage of the like size and design.
 - (d) Pockets. Darn or machine patch small rips at corners or broken seams.
 - (e) Hems. Turn under all frayed hems and stitch in place.
 - (f) Elasticized waistband. Replace missing or damaged waistband elastic with new parts of like size and design.
- (6) Resizing. Resize all garments after complete repair and cleaning according to Item group schedule of sizes listed below. When items deviate in size from original marking, obliterate the old marking and print or stamp the proper size with an indelible pencil or waterproof ink near old size. When the measurements do not correspond to a size listed, remark items to correspond to the next lowest size. Items with measurements falling below the lowest measurement in the schedule will not be accepted for remarking. Refer to appropriate table for measuring and sizing instructions for each garment.

21-6. WORKMANSHIP

All work shall be accomplished by personnel skilled in the particular trade applicable to their duties. Darning shall be neatly accomplished and patches shall be of the proper size and firmly stitched to the garments. Stitching and reseaming shall be secure and loose ends shall be turned and removed. Buttons, buckles and belt loops shall be securely and properly attached and function as intended. The finished items shall be complete and well repaired, thoroughly cleaned, and free from all defects which may affect serviceability or general appearances.

21-7. INSPECTION

The inspection or quality control unit is responsible for determining compliance with repair instructions and requirements for classification. In-process inspections will be performed for quality of workmanship and correct application of repair procedures. The completed item will be inspected for serviceable condition and appearance to insure against return of a sub-standard product to supply channels.

Section III. MATERIALS - Continued

(1) SMR CODE	(2) NATIONAL STOCK NUMBER	(3) DESCRIPTION	(4) UNIT OF ISSUE	
PAFZZ	8305-01-167-8403	COAT, WOMAN'S AND SLACKS, WOMAN'S MATERNITY WORK UNIFORM	YD	
PAFZZ	8310-01-066-0973	Cloth, Wind Resistant Poplin, Woodland, Camouflage Pattern, MIL-C-43468, Type III	YD	
PAFZZ	8315-00-899-0029	Thread, Cotton-covered Polyester, MIL-T-43548 Olive Drab S-1, C.A. 66022, Size 50, 3 Ply	TU	
PAFZZ	8315-00-899-0029	Button, Sewing Hole, V-B-871, Type II, Class D, Style 26, Size 30 Line, Olive Green C.A. 62016	GR	
PAFZZ	8310-00-262-0094	Thread, Gimp, Cotton, Olive Drab, C.A. 66022, V-T-280, Type II, Size 8, 3 Ply	SL	

★U.S. GOVERNMENT PRINTING OFFICE:1994-555-028/00205

Change 5 21-11/(21-12 blank)

CHAPTER 22

MAINTENANCE OF AIRCREW CLOTHING

Section I. INTRODUCTION

22-1. SCOPE.

This chapter describes the procedures and materials used in maintenance of Coat, Aircrew, Combat and Trousers, Aircrew, Combat. (Aircrew Battledress Uniform (ABDU))

22-2. SPECIFICATIONS.

a. End Items.

SPECIFICATION	ITEM
MIL-C-44371	Coat, Aircrew, Combat
MIL-T-44372	Trousers, Aircrew, Combat

b. Components.

SPECIFICATION	ITEM
MIL-C-83429	Cloth, Plain and Basket Weave, Aramid
A-A-50198	Thread, Gimp, Cotton, Buttonhole
A-A-50195	Thread, Aramid
MIL-T-44100	Thread, Para-Aramid, Spun, Intermediate Modulus
MIL-W-43685	Webbing
MIL-T-43709	Tape, Aramid
V-B-871	Buttons
MIL-B-543	Buckles, Adjustment Strap
MIL-F-21840	Fastener Tapes, Hook and Pile
V-F-106	Fastener, Slide, Interlocking

c. Drawings. US Army Natick Research and Development Command, Natick, MA 01760.

NUMBER	TITLE
2-1-2145	Coat, Aircrew, Combat
2-1-2188	Trousers, Aircrew, Combat

22-3. PUBLICATIONS.

NUMBER	TITLE
AR 32-4	Special Measurement Clothing and Footwear, Orthopedic Footwear, Guidons, Streamers and Flags
Fed Std. 751	Stitches, Seams and Stitching
FM 10-280	Field Laundry, Bath and Clothing Exchange Operations

22-4. IDENTIFICATION AND DESCRIPTION OF ITEMS.

a. Coat, Aircrew, Combat

NSN	SIZE	SPECIFICATION
8415-01-345-5204	X-SMALL SHORT, WOODLAND CAMOUFLAGE	MIL-C-44371
8415-01-345-5205	X-SMALL REGULAR, WOODLAND CAMOUFLAGE	MIL-C-44371
8415-01-345-5206	X-SMALL LONG, WOODLAND CAMOUFLAGE	MIL-C-44371
8415-01-345-5207	SMALL SHORT, WOODLAND CAMOUFLAGE	MIL-C-44371
8415-01-345-5208	SMALL REGULAR, WOODLAND CAMOUFLAGE	MIL-C-44371
8415-01-345-5209	SMALL LONG, WOODLAND CAMOUFLAGE	MIL-C-44371
8415-01-345-5210	MEDIUM SHORT, WOODLAND CAMOUFLAGE	MIL-C-44371
8415-01-345-5211	MEDIUM REGULAR, WOODLAND CAMOUFLAGE	MIL-C-44371
8415-01-345-5212	MEDIUM LONG, WOODLAND CAMOUFLAGE	MIL-C-44371
8415-01-345-5213	LARGE SHORT, WOODLAND CAMOUFLAGE	MIL-C-44371
8415-01-345-5214	LARGE REGULAR, WOODLAND CAMOUFLAGE	MIL-C-44371
8415-01-345-5215	LARGE LONG, WOODLAND CAMOUFLAGE	MIL-C-44371
8415-01-345-5216	X-LARGE SHORT, WOODLAND CAMOUFLAGE	MIL-C-44371
8415-01-345-5217	X-LARGE REGULAR, WOODLAND CAMOUFLAGE	MIL-C-44371
8415-01-345-5218	X-LARGE LONG, WOODLAND CAMOUFLAGE	MIL-C-44371
8415-01-328-8253	X-SMALL SHORT, TAN	MIL-C-44371
8415-01-328-8254	X-SMALL REGULAR, TAN	MIL-C-44371
8415-01-328-8252	X-SMALL LONG, TAN	MIL-C-44371
8415-01-328-8255	SMALL SHORT, TAN	MIL-C-44371
8415-01-328-8256	SMALL REGULAR, TAN	MIL-C-44371
8415-01-328-8257	SMALL LONG, TAN	MIL-C-44371
8415-01-328-8258	MEDIUM SHORT, TAN	MIL-C-44371
8415-01-328-8259	MEDIUM REGULAR, TAN	MIL-C-44371
8415-01-328-8260	MEDIUM LONG, TAN	MIL-C-44371
8415-01-328-8261	LARGE SHORT, TAN	MIL-C-44371
8415-01-328-8262	LARGE REGULAR, TAN	MIL-C-44371
8415-01-328-8263	LARGE LONG, TAN	MIL-C-44371
8415-01-328-8264	X-LARGE SHORT, TAN	MIL-C-44371
8415-01-328-8265	X-LARGE REGULAR, TAN	MIL-C-44371
8415-01-328-8266	X-LARGE LONG, TAN	MIL-C-44371

The aircrew coat (Figure 22-1), designed to temporarily protect aircrew members from fire, is made from Nomex fabric that is a high temperature resistant and inherently flame retardant synthetic fabric with no hot melt point or drip characteristics. The fabric is light-weight, will not support combustion, but will begin to char at 700° to 800° F (371° to 427°C) The fabric has good abrasion resistance and is non-absorbent. It may be either aramid or novoloid

22-4. SPECIFICATIONS AND PUBLICATIONS - Continued

fibers. The coat is a "bush-type" design with two breast and two lower patch pockets with flaps, a left sleeve utility pocket, hook and pile fastener tape adjustments for waist and sleeves, and a slide fastener front closure. The coat is produced in either a woodland camouflage or desert tan camouflage pattern.

NOTE

Individuals who cannot be fitted properly using these sizes may obtain special fitting in accordance with AR 32-4 Special Measurement Clothing.

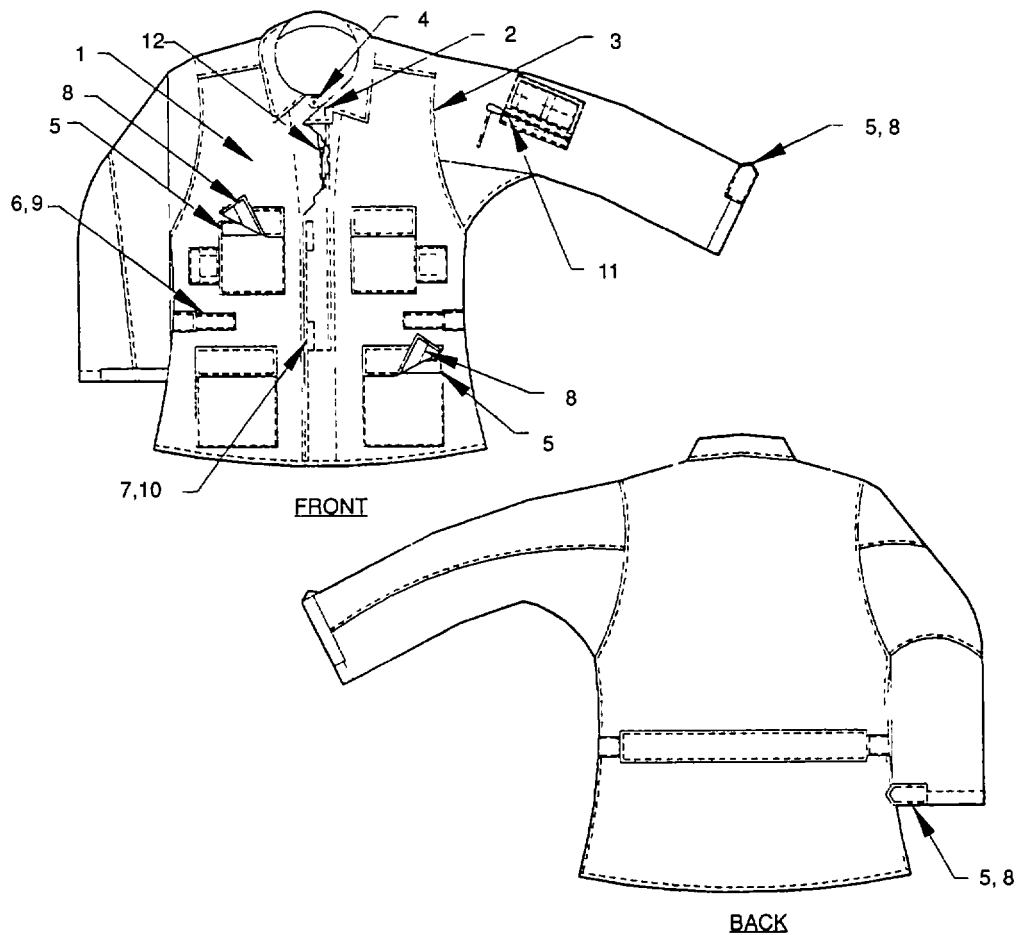

LEGEND

- | | | | |
|----|----------------------------|-----|----------------------------|
| 1. | Cloth | 7. | Hook Fastener Tape, 2" |
| 2. | Gimp Cotton | 8. | Pile Fastener Tape, 1" |
| 3. | Thread | 9. | Pile Fastener Tape, 1 1/2" |
| 4. | Button | 10. | Pile Fastener Tape, 2" |
| 5. | Hook Fastener Tape, 1" | 11. | Sleeve Slide Fastener |
| 6. | Hook Fastener Tape, 1 1/2" | 12. | Slide Fastener |

Figure 22-1 . Coat, Aircrew, Combat.

b. Trousers, Aircrew, Combat

NSN	SIZE	SPECIFICATION
8415-01-345-5219	X-SMALL SHORT, WOODLAND CAMOUFLAGE	MIL-T-44372
8415-01-345-5220	X-SMALL REGULAR, WOODLAND CAMOUFLAGE	MIL-T-44372
8415-01-345-5221	X-SMALL LONG, WOODLAND CAMOUFLAGE	MIL-T-44372
8415-01-345-5222	SMALL SHORT, WOODLAND CAMOUFLAGE	MIL-T-44372
8415-01-345-5223	SMALL REGULAR, WOODLAND CAMOUFLAGE	MIL-T-44372
8415-01-345-5224	SMALL LONG, WOODLAND CAMOUFLAGE	MIL-T-44372
8415-01-345-5225	MEDIUM SHORT, WOODLAND CAMOUFLAGE	MIL-T-44372
8415-01-345-5226	MEDIUM REGULAR, WOODLAND CAMOUFLAGE	MIL-T-44372
8415-01-345-5227	MEDIUM LONG, WOODLAND CAMOUFLAGE	MIL-T-44372
8415-01-345-5228	LARGE SHORT, WOODLAND CAMOUFLAGE	MIL-T-44372
8415-01-345-5229	LARGE REGULAR, WOODLAND CAMOUFLAGE	MIL-T-44372
8415-01-345-5230	LARGE LONG, WOODLAND CAMOUFLAGE	MIL-T-44372
8415-01-345-5231	X-LARGE SHORT, WOODLAND CAMOUFLAGE	MIL-T-44372
8415-01-345-5232	X-LARGE REGULAR, WOODLAND CAMOUFLAGE	MIL-T-44372
8415-01-345-5233	X-LARGE LONG, WOODLAND CAMOUFLAGE	MIL-T-44372
8415-01-328-8269	X-SMALL SHORT, TAN	MIL-T-44372
8415-01-328-8270	X-SMALL REGULAR, TAN	MIL-T-44372
8415-01-328-8271	X-SMALL LONG, TAN	MIL-T-44372
8415-01-328-8272	SMALL SHORT, TAN	MIL-T-44372
8415-01-328-8273	SMALL REGULAR, TAN	MIL-T-44372
8415-01-328-8274	SMALL LONG, TAN	MIL-T-44372
8415-01-328-8275	MEDIUM SHORT, TAN	MIL-T-44372
8415-01-328-8276	MEDIUM REGULAR, TAN	MIL-T-44372
8415-01-328-8277	MEDIUM LONG, TAN	MIL-T-44372
8415-01-328-8278	LARGE SHORT, TAN	MIL-T-44372
8415-01-328-8279	LARGE REGULAR, TAN	MIL-T-44372
8415-01-328-8280	LARGE LONG, TAN	MIL-T-44372
8415-01-328-8281	X-LARGE SHORT, TAN	MIL-T-44372
8415-01-328-8282	X-LARGE REGULAR, TAN	MIL-T-44372
8415-01-328-8283	X-LARGE LONG, TAN	MIL-T-44372

The aircrew trousers (Figure 22-2), designed to temporarily protect aircrew members from fire, are made from Nomex fabric that is a high temperature resistant and inherently flame retardant synthetic fabric with no hot melt point or drip characteristics. The fabric is light-weight, will not support combustion, but will begin to char at 700 to 800°F (371 ° to 427°C). The fabric has good abrasion resistance and is non-absorbent. It may be either aramid or novoloid fibers. The trousers have four standard type pockets, two thigh patch pockets, two lower leg patch pockets and a slide fastener fly closure. All pockets have flaps except for slide hanging pockets. The trousers are produced in either a woodland camouflage or a desert tan camouflage pattern.

NOTE

Individuals who cannot be fitted properly using these sizes may obtain special fitting in accordance with AR 32-4 Special Measurement Clothing.

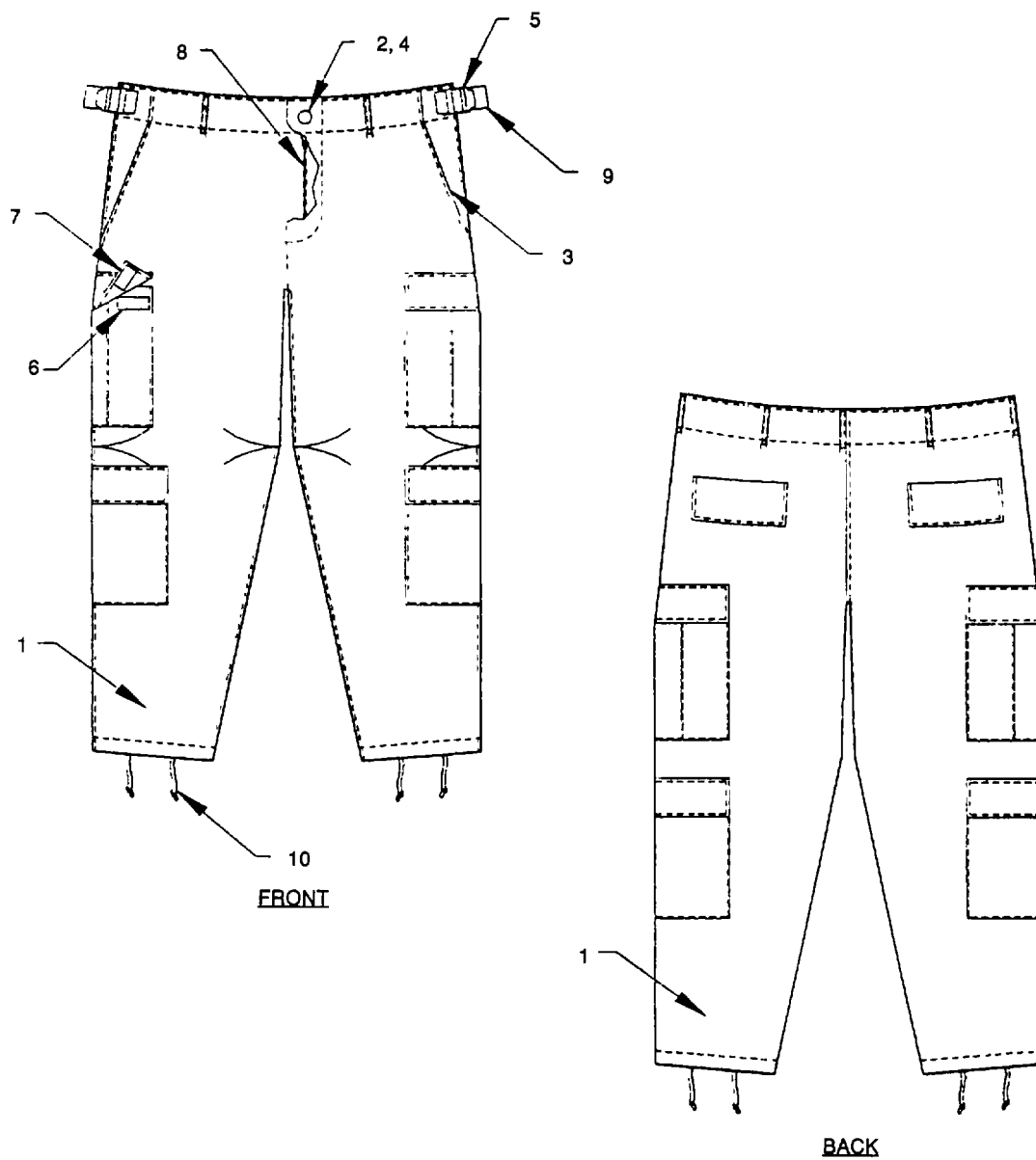

LEGEND

- | | | | |
|----|--------|-----|--------------------|
| 1. | Cloth | 6. | Hook Fastener Tape |
| 2. | Gimp | 7. | Pile Fastener Tape |
| 3. | Thread | 8. | Slide Fastener |
| 4. | Button | 9. | Webbing |
| 5. | Buckle | 10. | Tie Tape |

Figure 22-2 . Trousers, Aircrew, Combat

Section II. REPAIR PROCEDURES**22-5. MATERIALS**

Materials used in the repair of aircrew clothing will be serviceable materials recovered from similar salvaged items, except where specifically prohibited, or will be new materials. New materials will conform to the appropriate specifications and will be requisitioned from standard numbers, or part numbers, complete military standard numbers, or part number and Contractor and Government Entity Code (CAGEC) listed in Section III. Do not use substitute materials.

22-6. REPAIR OF AIRCREW CLOTHING.

Prior to repair operations, each item shall be inspected by qualified personnel to determine the amount of repair necessary. The following methods shall be observed as fully as skills, facilities, funds, and local conditions permit. The sequence of operations shall be determined by the repairing organizations, unless otherwise prescribed.

NOTE

Attachment of organizational Insignias is permissible. Method of attachment is a command option. If sewn, use MIL-T-44100 or A-A-50195.

a. Unit Repair.

- (1) Inspection. Inspect the aircrew coat and trousers to determine the extent of damage, normal wear and the need for repair. The material may begin to pill after some use (loose fibers may form on the surface of the material). This condition is normal and does not degrade the items serviceability. These pills may be removed by hand.
- (2) Cleaning. Hand or machine launder the aircrew coat and trousers with mild soap and water in accordance with paragraph 22-7 Cleaning. Rinse and air or machine dry.

WARNING

Make all repairs to aircrew clothing with MIL-T-44100 or A-A-50195 thread. Use of non-aramid thread type may cause hot spots and severe injury in case of fire.

- (3) Repair. Repairs to be accomplished at unit level will be hand sewing of rips, tears, loose seams and damaged button holes. Replace missing or damaged buttons and belt loops. Replacement buttons will match the original buttons in color, design, and size of the type specified in Section III.

b. Direct Support Maintenance.

- (1) Inspection. Dirt, mud, dust, spots, mildew stain and other foreign matter shall be removed by laundering. Mildewy and rotten items shall be discarded. Seams shall be tested by grasping the item with both hands and pulling at right angles to the seam. Areas to be repaired shall be marked with chalk. Non-specification and personnel marks shall be erased or obscured.

(2) Cleaning. Items shall be processed in laundry facilities in accordance with Formula I, FM 10-280, or Formula E, FM 10-17. When such facilities are not available, items shall be laundered by contract with private industry but strictly in accordance with one of the above listed formulas.

(3) Repair.

WARNING

Make all repairs to aircrew clothing with MIL-T-44100 or A-A-50195 thread. Use of non-aramid thread type may cause hot spots and severe Injury In case of fire.

- (a) Rips and tears. Repair rips and tears of 1/2 inch (1.27 cm) or less by darning in greatest dimension. Patch rips, tears, and holes exceeding 1/2 inch (1.27 cm) with a single patch of aramid cloth specified in Section III.
- (b) Stitching and restitching. Repair all stitches, seams and stitching on the aircrew clothing using stitching for various applications listed in Table 22-1. Seam allowances will be maintained with seams sewn so that no raw edges, runoffs, twists, pleats, puckers, or open seams occur. Overedge stitching will be 3/16 to 1/4 inch (0.48 to 0.63 cm) gauge.
- (c) Repair of type 301 stitching. Ends of all stitching, shall be backstitched or overstitched not less than 1 inch (2.54 cm) except where ends are turned under in a hem or held down by other seams or stitching. Ends of a continuous line of stitching shall overlap not less than 1/2 inch (1.27 cm). Thread tensions shall be not less than 1/2 inch (1.27 cm). Thread tensions shall be maintained so that there will be no loose stitching resulting in puckering of materials sewn. The lock shall be embedded in the materials sewn. When thread breaks, skipped stitches, run-offs, or bobbin runouts occur during stitching, the stitching shall be repaired by restarting the stitching a minimum of 1 inch (2.54 cm) in back of the interrupted stitching. Except for prestitching, thread breaks of two or more consecutive skipped or run-off stitches noted during inspection of the item shall be repaired by overstitching. The stitching shall start a minimum of 1 inch (2.54 cm) in back of defective area, continue over the defective area onto the existing stitching. Loose or excessively tight stitching shall be repaired by removing defective stitching without damaging the materials, and restitching in the required manner. When making above repairs, ends of stitching need not be backstitched.

Table 22-1. Stitching

ITEM REF PARA -	SEWING OPERATION	STITCH TYPE	THREAD NEEDLE AND BOBBIN	STITCHES PER INCH
6	General	301	60 TEX	10-12
6	General	401	60 TEX	10-12
6	Overedge Stitching	502	60 TEX	6-10
6	Overedge Stitching	503	60 TEX	6-10
6	Overedge Stitching	504	60 TEX	6-10
6	Safety Stitch	515	60 TEX	10-12
6	Safety Stitch	516	60 TEX	10-12
6	Safety Stitch	519	60 TEX	10-12
6	Bartacking		60 TEX	28 per bartack
6	Buttonholes		60 TEX	44-46 per buttonhole
6	Buttons	101 or 301	60 TEX	20-24 per button

* May be repaired by hand using double ply of E thread.

- (d) Type 401, 503, 504, 515, 516 stitching is repaired in the same manner as type 301, except that repairs to type 401 stitching requires both ends of all seams to have a 1/2 inch (1.27 cm) minimum chain extending beyond each end unless they are caught in a seam or other stitching.
 - (e) Patching and darning may be applied to any area of the garment. Repair small tears not more than 1/2 inch (1.27 cm) across with a darning or zigzag stitch. Repair rips, tears and thin areas greater than 1/2 inch (1.27 cm) but less than 4 inches (10.2 cm) by patching. Patch holes having a diameter of 1/2 inch (1.27 cm) but less than 4 inches (10.2 cm) by patching. Patches shall match the garment in color and type of material. Cut away the damaged area to a square or rectangular shape, depending upon the shape of the repaired area. Turn the raw edges under 3/8 inch (0.95 cm) and sew 1/8 inch (0.32 cm) from the edge. Cut the patch of sufficient size to extend at least 1/2 inch (1.27 cm) beyond the hole or area to be patched, allowing for a 3/8 inch (0.95 cm) turn under. Place the patch on the outside and sew it 1/8 inch (0.32 cm) from the edge of the patch using size 60 tex thread and type 301 stitching.
 - (f) Buttons. Replace missing, loose or damaged buttons with buttons conforming to those listed in Section III as applicable. Attach the buttons securely and aligned with eyelet end of respective buttonholes
 - (g) Buttonholes. Buttonholes shall be of the eyelet end taper bar type worked over gimp. Repair damaged buttonholes by reshaping enlarged buttonholes before reworking. Then pull buttonhole into shape and hand or machine whip a small reinforcement patch to the underside of the buttonhole. Then rework buttonhole through the patch.
 - (h) Belt loop. Replace missing, broken or torn belt loops with new parts of matching size and material. Such parts shall be fastened in a like manner to those being replaced and shall be properly positioned.
 - (i) Pockets. Darn or machine patch small holes, small rips at corners, and broken seams of pockets. Replace damaged patch pockets with new pocket of matching material and design. Inside hanging pockets shall be repaired by piecing, when required. Replace defective flaps except those flaps with very small holes that can be darned.
 - (j) Hem. Turn under all frayed hems and stitch in place.
 - (k) Waistband adjusting straps. Replace missing or damaged waistband straps with new parts of like size and design
 - (l) Buckles. Replace missing, broken, or damaged buckles in size and type specified in Section III.
 - (m) Slide fasteners. Replace missing or defective slide fasteners with parts conforming to the type specified in Section III. Installation shall be in the same manner as the original fastener. Refer to Table 22-4 for appropriate lengths.
 - (n) Hook and Pile Fastener. Any damaged hook and pile fastener tape may be replaced. Tapes shall conform to Type I, Specification MIL-F-21840. Tapes shall be replaced as originally installed.
- (4) Resizing. Resize all garments after complete repair and cleaning according to the item group schedule of sizes listed in Table 22-2 and Table 22-3. When items deviate in size from their original marking, obliterate the old marking and print or stamp the proper size with an indelible pencil or waterproof ink near the old size. When the measurements do not correspond to a size listed, remark the Items to correspond to the next lowest size. Items with measurements falling below the lowest measurement in the schedule will not be accepted as conditioned.

Table 22-2. Coat, Aircrew BDU, Sizing Instructions and Finished Measurements (In Inches)

SIZE	SHORT	REGULAR	LONG
Half Chest (1)			
X-Small	18-3/4	18-3/4	18-3/4
Small	20-3/4	20-3/4	20-3/4
X-Medium	22-3/4	22-3/4	22-3/4
Large	24-3/4	24-3/4	24-3/4
X-Large	26-3/4	26-3/4	26-3/4
Back Length (2)			
X-Small	28-3/4	30-1/4	31-1/2
Small	29-1/4	30-3/4	32-1/8
Medium	29-3/4	31-1/4	32-5/8
Large	30-1/4	31-3/4	33-1/8
X-Large	30-3/4	32-1/4	33-5/8
Sleeve Length (3)			
X-Small	23-1/2	24-1/2	25-1/2
Small	24	25	26
Medium	24-1/2	25-1/2	26-1/2
Large	25-1/2	26-1/2	27-1/2
X-Large	26-1/2	27-1/2	28-1/2

- (1) Half Chest: Coat front closed, at base of armhole from folded edge to folded edge + 3/4 Inch tolerance.
(2) Back Length: At center of back, from collar seam to bottom of coat + 3/4 Inch tolerance.
(3) Sleeve Length: Along center of top sleeve from top of sleeve to bottom edge of hem + 1/2 inch tolerance

Table 22-3 Trousers, Aircrew BDU, Sizing Instructions and Finished Measurements (in inches)

SIZE	1/2 WAIST (1)	INSEAM (2)
X-Small-Short	13-3/4	31-3/4
X-Small-Regular	13-3/4	33-3/4
X-Small-Long	13-3/4	35-3/4
Small-Short	15-3/4	31-3/4
Small-Regular	15-3/4	33-3/4
Small-Long	15-3/4	35-3/4
Medium-Short	17-3/4	31-3/4
Medium-Regular	17-3/4	33-3/4
Medium-Long	17-3/4	35-3/4

Table 22-3. Trousers, Aircrew BDU, Sizing Instructions and Finished Measurements (in inches) - Cont'd

SIZE	1/2 WAIST (1)	INSEAM (2)
Large-Short	19-3/4	31-3/4
Large-Regular	19-3/4	33-3/4
Large-Long	19-3/4	35-3/4
X-Large-Short	21-3/4	31-3/4
X-Large-Regular	21-3/4	33-3/4
X-Large-Long	21-3/4	35-3/4
X-Small-Short, Tan	13-3/4	31-3/4
X-Small-Regular, Tan	13-3/4	33-3/4
X-Small-Long, Tan	13-3/4	35-3/4
Small-Short, Tan	15-3/4	31-3/4
Small-Regular, Tan	15-3/4	33-3/4
Small-Long, Tan	15-3/4	35-3/4
Medium-Short, Tan	17-3/4	31-3/4
Medium-Regular, Tan	17-3/4	33-3/4
Medium-Long, Tan	17-3/4	35-3/4
Large-Short, Tan	19-3/4	31-3/4
Large-Regular, Tan	19-3/4	33-3/4
Large-Long, Tan	19-3/4	35-3/4
X-Large-Short, Tan	21-3/4	31-3/4
X-Large-Regular, Tan	21-3/4	33-3/4
X-Large-Long, Tan	21-3/4	35-3/4

(1) Half Waist Slide fastener and button closed; In center of waist band from folded edge to folded edge, + 1/2 inch tolerance

(2) Inseam: From center to crotch seam to bottom of leg + 3/4 Inch tolerance.

Table 22-4. Slide Fastener Lengths (in inches)

SIZE	COAT	TROUSERS
X-Small-Short	15	6-1/2
X-Small-Regular	15-1/2	7
X-Small-Long	16	7-1/2
Small-Short	15-1/2	7
Small-Regular	16	7-1/2
Small-Long	16-1/2	8
Medium-Short	16	7-1/2
Medium-Regular	16-1/2	8
Medium-Long	17	8-1/2
Large-Short	16-1/2	8
Large-Regular	17	8-1/2
Large-Long	17-1/2	9
X-Large-Short	17	8-1/2
X-Large-Regular	17-1/2	9
X-Large-Long	18	9-1/2

22-7. CLEANING.

Laundering in water up to 180°F (82.2°C) maximum and tumble drying up to 180°F (82.2°C), will not damage or shrink the aircrew battle dress uniform. Use of a commercial fabric softener (STAY-PUFF, DOWNY, etc.) during rinse, will remove body oil during laundry process. The fabric softeners also serve to remove wrinkles or creases, due to the high temperature resistant quality of Nomex fabric. Dry cleaning or laundering will not compromise the flame retardant properties of the "NOMEX" and no renewable flame retardant treatment is required.

NOTE

- **It is recommended that a new coat or trousers be laundered prior to use in order to soften the fabric and eliminate any possible skin irritation that might occur due to original fabric harshness. It is recommended that immediately after tumble drying or during drip drying, the uniform be hung on a hanger.**
- **DO NOT STARCH these uniforms. In event that the uniform is inadvertently starched, restore the fire resistance to its original state by rinsing the garment in warm water.**
- **Do not use any type of bleaching compound in laundering.**
- **After ten laundering cycles and thereafter launder in accordance with Formula IX (no bleach) of FM 10-280 and Natick Formula X, fixed laundry for the retreatment of anti-static agent.**

22-8. WORKMANSHIP.

Repair and cleaning will be done by personnel skilled in their duties.

22-9. INSPECTION.

After complete repair, inspect each item and its components to determine if they meet the criteria in Chapter 1 listed under Classification B. The inspection or quality control unit is responsible for preventing return of sub-standard product to supply channels.

Section III. MATERIALS

FIG. NO.	ITEM NO.	SMR CODE	NSN	DESCRIPTION	UNIT OF ISSUE
22-1	1	XBFZZ	8305-01-345-5234	COAT, AIRCREW, COMBAT Cloth, Plain and Basket Weave, Aramid, Conforming to Type II, CI 5, Woodland Camo # 483, of MIL-C-83429.	RO
22-1	1	XBFZZ	8305-00-000-0171	Cloth, Plain and Basket Weave, Aramid, Conforming to Type II, CI 6, Desert Tan # 380, of MIL-C-83429.	RO
22-1	2	PAFZZ	8310-00-262-0094	Thread, Gimp, Cotton, Buttonhole: Shade OD-SL, C.A.66022, Conforming to Size 8, Type I or II of A-A-50198.	SL
22-1	2	PAFZZ		Thread, Gimp, Cotton, Buttonhole: Shade # 380, C.A. 66022, Conforming to Size 8, Type I or II of A-A-50198. Source: Thread USA, PO Box 750, Gastonia, NC 28052.	SL
22-1	3	PAFZZ	8310-00-492-8397	Thread, Aramid, Shade # 483, C.A. 66022, Conforming to Type I, 60 Tex of A-A-50195	TU
22-1	3	PAFZZ		Thread, Aramid, Shade # 380, C.A. 66022, Conforming to Type I, 60 Tex of A-A-50195. Source: Atlantic Thread Co., PO Box 11395, Baltimore, MD 21239.	TU
22-1	3	PAFZZ		Thread, Para-aramid, Spun, Intermediate Modulus, Shade # 483, Conforming to 60 Tex of MIL-T-44100. Source: Atlantic Thread Co., PO Box 11395, Baltimore, MD 21239.	TU
22-1	3	PAFZZ		Thread, Para-aramid, Spun, Intermediate Modulus, Shade # 380, Conforming to 60 Tex of MIL-T-44100. Source: Atlantic Thread Co., PO Box 11395, Baltimore, MD 21239	TU
22-1	4	PAFZZ		8315-00-899-0029 Buttons, DoD Shade BP # 483, Cable No. 62016, Dull Finish, Size 30 Line, Conforming to Type II, Class D, Style 26 of V-B-871	GR

Section III. MATERIALS - Continued

FIG. NO.	ITEM NO.	SMR CODE	NSN	DESCRIPTION	UNIT OF ISSUE
22-1	4	PAFZZ		Buttons, DoD Shade # 380, Cable No 62016, Dull Finish, Size 30 Line, Conforming to Type II, Class D, Style 26 of V-B-871. Source: US Button Corp, 328 Kennedy Dr, Putnum, CT 06260.	GR
22-1	5	PAFZZ	8315-00-151-6480	Fastener Tape: Hook, Conforming to Type I, CI 1, 1 in, Shade OG-106, of MIL-F-21840.	YD
22-1	5	PAFZZ		Fastener Tape: Hook, Conforming to Type I, CI 1, 1 in, Shade # 380, of MIL-F-21840 Source. US Slide Fastener Corp, 21 Drydock Ave, Boston, MA 02210.	YD
22-1	6	PAFZZ	8315-00-151-6481	Fastener Tape: Hook, Conforming to Type I, CI 1, 1-1/2 in, Shade OG-106, of MIL-F-21840.	YD
22-1	6	PAFZZ		Fastener Tape. Hook, Conforming to Type I, CI 1, 1-1/2 in, Shade # 380, of MIL-F-21840. Source US Slide Fastener Corp, 21 Drydock Ave, Boston, MA 02210.	YD
22-1	7	PAFZZ	8315-00-151-6479	Fastener Tape. Hook, Conforming to Type I, CI 1, 2 in, Shade OG-106, of MIL-F-21840.	YD
22-1	7	PAFZZ		Fastener Tape. Hook, Conforming to Type I, CI 1, 2 in, Shade # 380, of MIL-F-21840. Source. US Slide Fastener Corp, 21 Drydock Ave, Boston, MA 02210	YD
22-1	8	PAFZZ	8315-00-151-6484	Fastener Tape: Pile, Conforming to Type I, CI 1, 1 in, Shade OG-106, of MIL-F-21840.	YD
22-1	8	PAFZZ		Fastener Tape: Pile, Conforming to Type I, CI 1, 1 in, Shade # 380, of MIL-F-21840. Source: US Slide Fastener Corp, 21 Drydock Ave, Boston, MA 02210.	YD
22-1	9	PAFZZ	8315-00-151-6483	Fastener Tape: Pile, Conforming to Type I, CI 1, 1-1/2 in, Shade OG-106, of MIL-F-21840.	YD

Section III. MATERIALS - Continued

FIG. NO.	ITEM NO.	SMR CODE	NSN	DESCRIPTION	UNIT OF ISSUE																																																
22-1	9	PAFZZ		Fastener Tape: Pile, Conforming to Type I, CI 1, 1-1/2 in, Shade # 380, of MIL-F-21840. Source: US Slide Fastener Corp, 21 Dry-dock Ave, Boston, MA 02210.	YD																																																
22-1	10	PAFZZ	8315-00-151-6482	Fastener Tape: Pile, Conforming to Type I, CI 1, 2 in, Shade OG-106, of MIL-F-21840.	YD																																																
22-1	10	PAFZZ		Fastener Tape: Pile, Conforming to Type I, CI 1, 2 in, Shade # 380, of MIL-F-21840. Source: US Slide Fastener Corp, 21 Dry-dock Ave, Boston, MA 02210.	YD																																																
22-1	11	PAFZZ	5225-00-159-3722	Fastener, Slide, Sleeve, Interlocking, 4 3/4 in, Type I, Style 7, size MS of V-F-106 w/OG 106 Tape.	EA																																																
22-1	12	PAFZZ		Fastener, Slide: Interlocking, Type IV, Style 8, Size MS of V-F-106 w/OG 106 Tape. Source: See page 22-17	EA																																																
				<table border="0"> <tr> <td>Size</td> <td>Inch</td> <td>Cm</td> </tr> <tr> <td>XSS</td> <td>15</td> <td>38.1</td> </tr> <tr> <td>XSR</td> <td>15 1/2</td> <td>39.3</td> </tr> <tr> <td>XSL</td> <td>16</td> <td>40.6</td> </tr> <tr> <td>SS</td> <td>15 1/2</td> <td>39.3</td> </tr> <tr> <td>SR</td> <td>16</td> <td>40.6</td> </tr> <tr> <td>SL</td> <td>16 1/2</td> <td>41.9</td> </tr> <tr> <td>MS</td> <td>16</td> <td>40.6</td> </tr> <tr> <td>MR</td> <td>16 1/2</td> <td>41.9</td> </tr> <tr> <td>ML</td> <td>17</td> <td>43.2</td> </tr> <tr> <td>LS</td> <td>16 1/2</td> <td>41.9</td> </tr> <tr> <td>LR</td> <td>17</td> <td>43.2</td> </tr> <tr> <td>LL</td> <td>17 1/2</td> <td>44.4</td> </tr> <tr> <td>XLS</td> <td>17</td> <td>43.2</td> </tr> <tr> <td>XLR</td> <td>17 1/2</td> <td>44.4</td> </tr> <tr> <td>XLL</td> <td>18</td> <td>45.72</td> </tr> </table>	Size	Inch	Cm	XSS	15	38.1	XSR	15 1/2	39.3	XSL	16	40.6	SS	15 1/2	39.3	SR	16	40.6	SL	16 1/2	41.9	MS	16	40.6	MR	16 1/2	41.9	ML	17	43.2	LS	16 1/2	41.9	LR	17	43.2	LL	17 1/2	44.4	XLS	17	43.2	XLR	17 1/2	44.4	XLL	18	45.72	
Size	Inch	Cm																																																			
XSS	15	38.1																																																			
XSR	15 1/2	39.3																																																			
XSL	16	40.6																																																			
SS	15 1/2	39.3																																																			
SR	16	40.6																																																			
SL	16 1/2	41.9																																																			
MS	16	40.6																																																			
MR	16 1/2	41.9																																																			
ML	17	43.2																																																			
LS	16 1/2	41.9																																																			
LR	17	43.2																																																			
LL	17 1/2	44.4																																																			
XLS	17	43.2																																																			
XLR	17 1/2	44.4																																																			
XLL	18	45.72																																																			
				TROUSERS, AIRCREW, COMBAT																																																	
22-2	1	XBFZZ		Cloth, Plain and Basket Weave, Aramid, Conforming to Type II, CI 5, Woodland Camo # 483, of MIL-C-83429.	RO																																																

Section III. MATERIALS - Continued

FIG. NO.	ITEM NO.	SMR CODE	NSN	DESCRIPTION	UNIT OF ISSUE
22-2	1	XBFZZ		Cloth, Plain and Basket Weave, Aramid, Conforming to Type II, CI 6, Desert Tan # 380, of MIL-C-83429.	RO
22-2	2	PAFZZ	8310-00-262-0094	Thread, Gimp, Cotton, Buttonhole: Shade OD-SL, C.A. 66022, Conforming to Size 8, Type I or II of A-A-50198.	SL
22-2	2	PAFZZ		Thread, Gimp, Cotton, Buttonhole: Shade # 380, C.A. 66022, Conforming to Size 8, Type I or II of A-A-50198. Source: Thread USA, PO Box 750, Gastonia, NC 28052.	SL
22-2	3	PAFZZ	8310-00-492-8397	Thread, Aramid, Shade # 483, C.A. 66022, Conforming to Type I, 60 Tex of A-A-50195.	TU
22-2	3	PAFZZ		Thread, Aramid, Shade # 380, C.A. 66022, Conforming to Type I, 60 Tex of A-A-50195. Source: Atlantic Thread Co., PO Box 11395, Baltimore, MD 21239.	TU
22-2	3	PAFZZ		Thread, Para-aramid, Spun, Intermediate Modulus, Shade # 483, Conforming to 60 Tex of MIL-T-441 00. Source: Atlantic Thread Co., PO Box 11395, Baltimore, MD 21239.	TU
22-2	3	PAFZZ		Thread, Para-aramid, Spun, Intermediate Modulus, Shade # 380, Conforming to 60 Tex of MIL-T-44100. Source: Atlantic Thread Co., PO Box 11395, Baltimore, MD 21239.	TU
22-2	4	PAFZZ	8315-00-899-0029	Buttons, DoD Shade BP # 483, Cable No. 62016, Dull Finish, Size 30 Line, Conforming to Type II, Class D, Style 26 of V-B-871.	GR
22-2	4	PAFZZ		Buttons, DoD Shade # 380, Cable No. 62016, Dull Finish, Size 30 Line, Conforming to Type II, Class D, Style 26 of V-B-871. Source: US Button Corp, 328 Kennedy Dr, Putnum, CT 06260.	GR
22-2	5	PAFZZ	5340-00-157-7987	Buckles, Adjustment Strap: Conform to Type II, Style 3, Class 3 of MIL-B-543 (use Salvage Items).	EA

Section III. MATERIALS - Continued

FIG. NO.	ITEM NO.	SMR CODE	NSN	DESCRIPTION	UNIT OF ISSUE																																																													
22-2	6	PAFZZ	8315-00-151-6480	Fastener Tape: Hook, Conforming to Type I, CI 1, 1 in, Shade OG-1 06, of MIL-F-21840.	YD																																																													
22-2	6	PAFZZ		Fastener Tape: Hook, Conforming to Type I, CI 1, 1 in, Shade # 380, of MIL-F-21840. Source: US Slide Fastener Corp, 21 Drydock Ave, Boston, MA 02210.	YD																																																													
22-2	7	PAFZZ	8315-00-151-6484	Fastener Tape: Pile, Conforming to Type I, CI 1, 1 in, Shade OG-106, of MIL-F-21840.	YD																																																													
22-2	7	PAFZZ		Fastener Tape: Pile, Conforming to Type I, CI 1, 1 in, Shade # 380, of MIL-F-21840. Source: US Slide Fastener Corp, 21 Drydock Ave, Boston, MA 02210.																																																														
22-2	8	PAFZZ		Fastener, Slide. Interlocking, Type I, Style 3, Size MS of V-F-106 w/OG 106 Tape. Source: See page 22-17.	EA																																																													
				<table border="0"> <tr> <td>Size</td> <td>Inch</td> <td>Cm</td> </tr> <tr> <td>XSS</td> <td>6-1/2</td> <td>16.5</td> </tr> <tr> <td>XSR</td> <td>7</td> <td>17.8</td> </tr> <tr> <td>5325-01-273-2341</td> <td>XSL</td> <td>7-1/2</td> <td>19</td> </tr> <tr> <td></td> <td>SS</td> <td>7</td> <td>17.8</td> </tr> <tr> <td>5325-01-273-2341</td> <td>SR</td> <td>7-1/2</td> <td>19</td> </tr> <tr> <td>5325-01-273-1705</td> <td>SL</td> <td>8</td> <td>20.3</td> </tr> <tr> <td>5325-01-273-2341</td> <td>MS</td> <td>7-1/2</td> <td>19</td> </tr> <tr> <td>5325-01-273-1705</td> <td>MR</td> <td>8</td> <td>20.3</td> </tr> <tr> <td>5325-01-272-6584</td> <td>ML</td> <td>8-1/2</td> <td>21.5</td> </tr> <tr> <td>5325-01-273-1705</td> <td>LS</td> <td>8</td> <td>20.3</td> </tr> <tr> <td>5325-01-272-6584</td> <td>LR</td> <td>8-1/2</td> <td>21.5</td> </tr> <tr> <td>5325-01-2743313</td> <td>LL</td> <td>9</td> <td>22.8</td> </tr> <tr> <td>5325-01-272-6584</td> <td>XLS</td> <td>8-1/2</td> <td>21.5</td> </tr> <tr> <td>5325-01-274-3313</td> <td>XLR</td> <td>9</td> <td>22.8</td> </tr> <tr> <td>5325-01-274-3314</td> <td>XLL</td> <td>9-1/2</td> <td>24</td> </tr> </table>	Size	Inch	Cm	XSS	6-1/2	16.5	XSR	7	17.8	5325-01-273-2341	XSL	7-1/2	19		SS	7	17.8	5325-01-273-2341	SR	7-1/2	19	5325-01-273-1705	SL	8	20.3	5325-01-273-2341	MS	7-1/2	19	5325-01-273-1705	MR	8	20.3	5325-01-272-6584	ML	8-1/2	21.5	5325-01-273-1705	LS	8	20.3	5325-01-272-6584	LR	8-1/2	21.5	5325-01-2743313	LL	9	22.8	5325-01-272-6584	XLS	8-1/2	21.5	5325-01-274-3313	XLR	9	22.8	5325-01-274-3314	XLL	9-1/2	24	
Size	Inch	Cm																																																																
XSS	6-1/2	16.5																																																																
XSR	7	17.8																																																																
5325-01-273-2341	XSL	7-1/2	19																																																															
	SS	7	17.8																																																															
5325-01-273-2341	SR	7-1/2	19																																																															
5325-01-273-1705	SL	8	20.3																																																															
5325-01-273-2341	MS	7-1/2	19																																																															
5325-01-273-1705	MR	8	20.3																																																															
5325-01-272-6584	ML	8-1/2	21.5																																																															
5325-01-273-1705	LS	8	20.3																																																															
5325-01-272-6584	LR	8-1/2	21.5																																																															
5325-01-2743313	LL	9	22.8																																																															
5325-01-272-6584	XLS	8-1/2	21.5																																																															
5325-01-274-3313	XLR	9	22.8																																																															
5325-01-274-3314	XLL	9-1/2	24																																																															

Section III. MATERIALS - Continued

FIG. NO.	ITEM NO.	SMR CODE	NSN	DESCRIPTION	UNIT OF ISSUE
22-2	9	PAFZZ	8305-00-406-3496	Webbing, Conforming to Type I of MIL-W-43685 (use Salvage Straps). Tape, Aramid, Conforming to MIL-T-43709 (1/4" width).	YD
22-2	10	PAFZZ	8315-00-405-2298		YD

Section III. MATERIALS - Continued

GARMENT SIZE CODE LEGEND:

XSS	X-SMALL SHORT	LS	LARGE SHORT
XSR	X-SMALL REGULAR	LR	LARGE REGULAR
XSL	X-SMALL LONG	LL	LARGE LONG
SS	SMALL SHORT	XLS	X-LARGE SHORT
SR	SMALL REGULAR	XLR	X-LARGE REGULAR
SL	SMALL LONG	XLL	X-LARGE LONG
MS	MEDIUM SHORT		
MR	MEDIUM REGULAR		
ML	MEDIUM LONG		

Commercial Sources for Slide Fasteners are:

YKK USA, Inc.
171 Rittenhouse Circle
Bristol, PA 19007
(215) 785-1200

Talon Co.
3535 N.W. 58th St.
Miami, FL 33142
(305) 633-9025

Diversified Marketing Group
230 Windsor Ave
Suite 207
Narberth, PA 19072
(215) 667-5589

**CHAPTER 23
REPAIR AND MAINTENANCE OF TWO PIECE CHEMICAL PROTECTIVE UNDERWEAR
(TRAINING GARMENTS ONLY)**

Section I. INTRODUCTION

23-1. SCOPE.

This chapter describes the procedures and materials used in maintenance of Two Piece Chemical Protective Underwear (CPU). This chapter refers to CPU used for training purposes only.

23-2. COMMODITY SPECIFICATIONS.

a. Item.

SPECIFICATION	ITEM
MIL-U.44435 (GL)	Underwear, Chemical Protective, Two Piece (Undershirt and Drawers)

b. Components.

SPECIFICATION	ITEM
A-A-50199	Thread, Polyester Core, Cotton - or Polyester-Covered
A-A-52095	Thread, Polyester, Textured
V-F-106	Fasteners, Slide, Interlocking
DDD-L-20	Label: For Clothing, Equipage, and Tentage, (General Use)
PPP-B-636	Boxes, Shipping Fiberboard
PPP-F-320	Fiberboard: Corrugated and Solid, Sheet Stock (Container Grade) and Out Shapes
MIL-B-44433	Bag Barrier, Multi-layer Film
MIL-D-3464	Desiccants, Activated, Bagged, Packaging Use and Static Dehumidification
MIL-F-21840	Fastener Tapes, Hook and Loop, Synthetic
MIL-L-35078	Loads Unit: Preparation of Semiperishable Subsistence Items; Clothing, Personal Equipment, Equipage; General Specification For

23-3 PUBLICATIONS.

NUMBER	TITLE
FED-STD-101	Test Procedures for Packaging Materials
FED-STD-751	Stitches, Seams, and Stitchings
MIL-STD-105	Sampling Procedures and Tables for Inspection by Attributes
MIL-STD-129	Marking for Shipment and Storage
MIL-STD-147	Palletized Unit Loads
FM 10-16	General Fabric Repair
FM 10-280	Mobil Field Laundry, Clothing Exchange and Bath Operations

23-4. IDENTIFICATION AND DESCRIPTION.

Two Piece Chemical Protective Underwear.

a. Undershirt

NSN	SIZES	SPECIFICATION
8415-01-363-8692	32	MIL-U-44435
8415-01-363-8693	34	MIL-U-44435
8415-01-363-8694	36	MIL-U-44435
8415-01-363-8695	38	MIL-U-44435
8415-01-363-8696	40	MIL-U-44435
8415-01-363-8697	42	MIL-U-44435
8415-01-363-8698	44	MIL-U-44435
8415-01-363-8699	46	MIL-U-44435
8415-01-363-8700	48	MIL-U-44435

b. Drawers.

NSN	SIZES	SPECIFICATION
8415-01 -373-8683	26	MIL-U-44435
8415-01-363-8684	28	MIL-U-44435
8415-01-363-8685	30	MIL-U-44435
8415-01 -363-8686	32	MIL-U-44435
8415-01-363-8687	34	MIL-U-44435
8415-01-363-8688	36	MIL-U-44435
8415-01-363-8689	38	MIL-U-44435
8415-01-363-8690	40	MIL-U-44435
8415-01 -363-8691	42	MIL-U-44435

23-4 IDENTIFICATION AND DESCRIPTION - Continued

Chemical Protective Underwear (CPU) (Figure 23-1) undershirt and drawers are issued separately, but are intended to be worn together as a uniform. The CPU is composed of state-of-the-art materials which provide chemical protection. The protective system worn under a standard duty uniform, is somewhat resistant to water, petroleum, oils and lubricants (POL's). The undershirt and drawers are composed of a breathable material which allows perspiration to escape. The undershirt is a hip-length design with a stand-up collar full length sleeves, with adjustable hook and loop fastener tapes, and a full front closure with slide fastener. The drawers are a basic long-john type design.

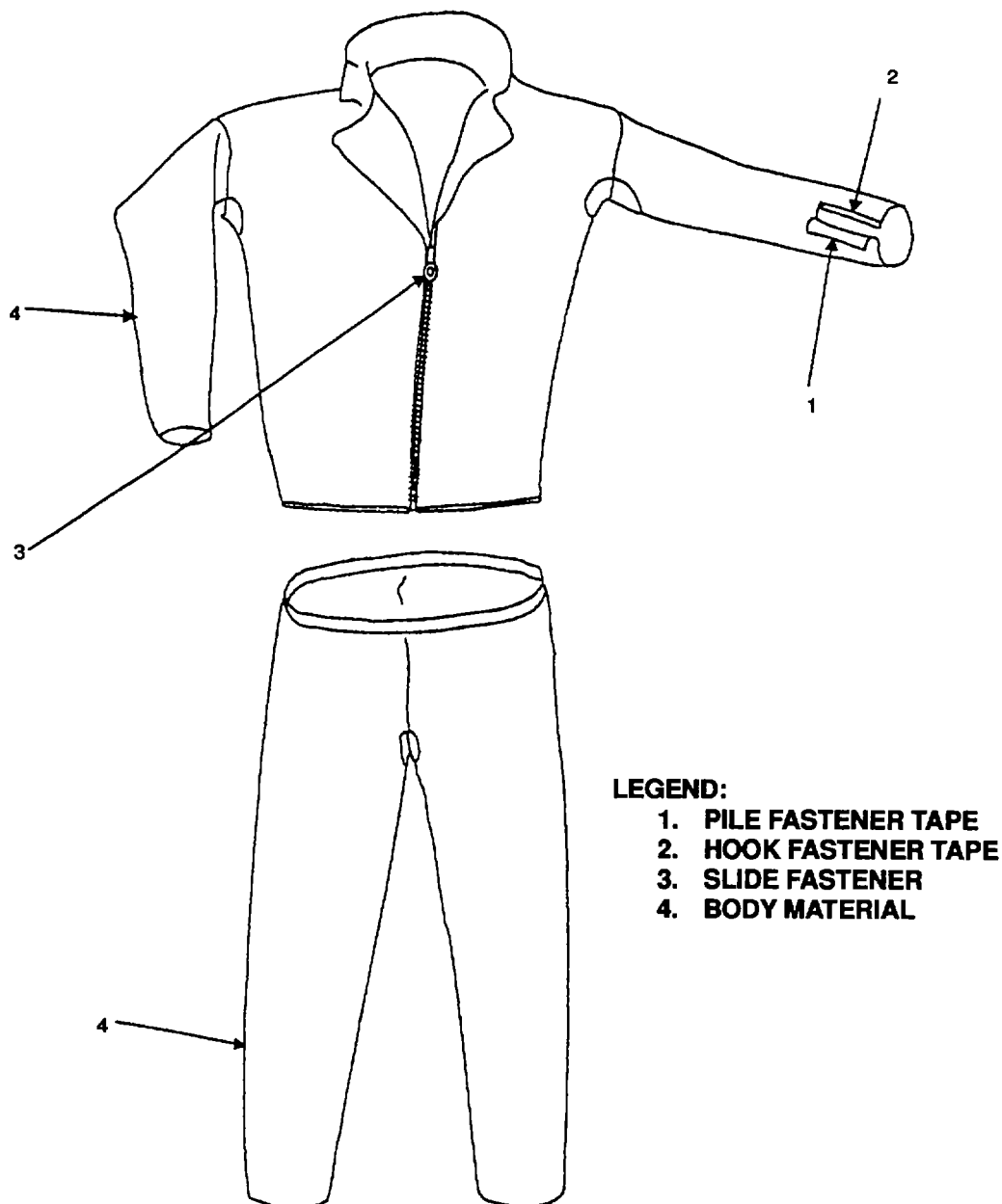

Figure 23-1 . Two Piece Chemical Protective Underwear (Undershirt and Drawers)

Section II. REPAIR PROCEDURES

23-5. MATERIALS.

- a. General. Materials used in the repair of CPU will be serviceable materials recovered from similar salvaged items, except where specifically prohibited, or will be new materials.
- b. New Materials. New materials will conform to the appropriate specifications and will be requisitioned from stock using national stock numbers, complete military standard numbers, or part number and Contractor and Government Entity Code (CAGEC) listed in section III. When not available from stock, materials conforming as closely as possible to the standard material may be purchased locally.

23-6 REPAIR OF CPU (UNDERSHIRT AND DRAWERS).

NOTE

Fielded Items will not be repaired. This chapter is for repair of training garments only. Wide latitude for repair is encouraged. CPU with rips, tears, or required repairs will not be issued to the soldier for protection against chemical agents.

- a. General. Prior to repair, each item will be inspected to determine the amount of repair necessary. All repairs to components of the CPU will be accomplished at the direct support level. FM 10-16 will be used as a general guide. Repair of the CPU is authorized for training garments only.
- b. Repair Procedures:
 - (1) Preliminary Examination. Remove all dirt, mud, dust, spots, stains and other foreign matter with a brush before examining the garment. Seams will be tested by firmly grasping the item with both hands and pulling at right angles to the seams. Areas to be repaired shall be marked by means of tape or chalk or other removable means. Nonspecific and personal marks shall be erased or obliterated.
 - (2) Rips and tears. (Figure 23-2)
 - (a) To mend a ripped seam, overlap the two edges and hand sew or 301 machine stitch with straight and small stitches. (Figure 23-2, A).
 - (b) To repair a tear, place the two edges together and neatly hand sew using a whip stitch. (Figure 23-2, B).
 - (c) To mend a frayed edge, turn the frayed edge under and hand sew or 301 machine stitch this turned edge. (Figure 23-2, C).
 - (3) Field Expedient Repair or Temporary Measures.
 - (a) Loosely whip stitch a rip or tear, keeping the seam as flat as possible. Trim all thread ends.
 - (b) Field taping (duct tape or other tape sufficient to patch). Keeping the rip or tear as flat as possible, tape over the puncture. Cut the appropriate size of tape to cover the rip or tear. Round the edges of the tape to reduce fraying. Place the tape over the rip or tear and press firmly.

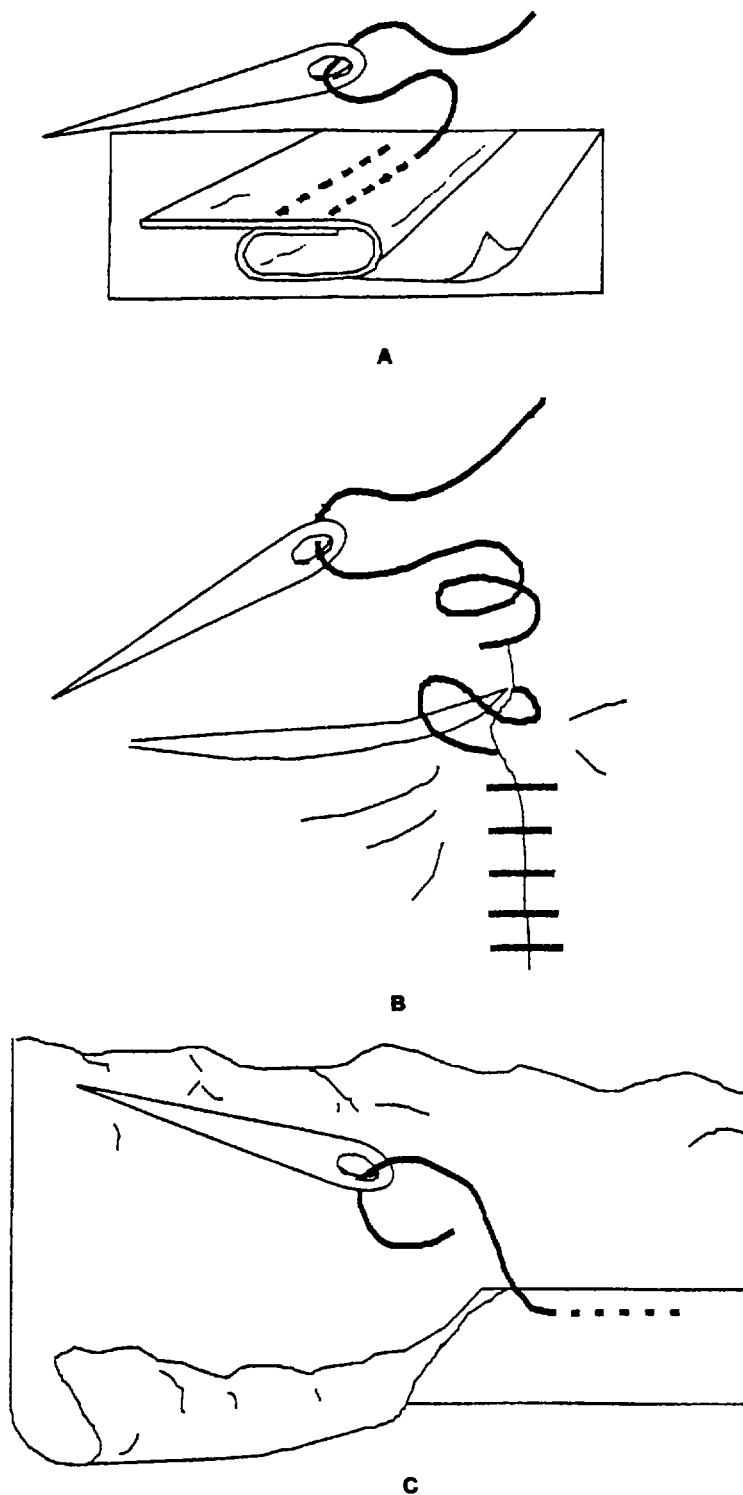

Figure 23-2. Two Piece Chemical Protective Underwear, Repair

23-6. REPAIR OF CPU (UNDERSHIRT AND DRAWERS) - Continued

- (4) Slide Fasteners. Replace damaged, missing, or malfunctioning slide fastener with serviceable one.
- (5) Hook and Loop Pile Fastener Tapes. Replace damaged or missing Hook and Loop Pile Fasteners.

23-7. RESIZING.

After cleaning and repair, resize garments according to sizes listed in Table 23-1 and Table 23-2 below. When garments vary in size from original marking, obliterate old marking and re-mark with proper size using indelible pencil or waterproof ink. When actual measurements do not correspond to the size indicated, relabel to the next lowest size.

Table 23-1. Undershirt Finished Measurements

SIZE	1/2 CHEST <u>1/</u> IN (CM)	BACK LENGTH <u>2/</u> IN (CM)	SLEEVE LENGTH <u>3/</u> IN (CM)	1/2 NECK <u>4/</u> IN (CM)
32	14 1/2 (36.83)	26 1/4 (66.67)	18 (45.72)	8 (20.32)
34	15 1/2 (39.37)	27 (68.58)	18 1/2 (46.99)	8 1/4 (20.95)
36	16 1/2 (41.91)	27 3/4 (70.48)	19 (48.26)	8 1/2 (21.59)
38	17 1/2 (44.45)	28 1/2 (72.39)	19 1/2 (49.53)	8 3/4 (22.22)
40	18 1/2 (46.99)	29 1/4 (74.29)	20 (50.80)	9 (22.86)
42	19 1/2 (49.53)	30 (76.20)	20 1/2 (52.07)	9 1/4 (23.49)
44	20 1/2 (52.07)	30 3/4 (78.10)	21 (53.34)	9 1/2 (24.13)
46	21 1/2 (54.61)	31 1/2 (80.01)	21 1/2 (54.61)	9 3/4 (24.76)
48	22 1/2 (57.15)	32 1/4 (81.91)	22 (55.88)	10 (25.40)
Tolerance	±1/2	+ 3/4, - 1/2	± 1/2	±1/4

- 1/ Measure at base of armhole, from folded edge to folded edge.
- 2/ Measure along center back from collar seam to bottom of shirt.
- 3/ Measure along underarm seam from bottom of armhole to sleeve cuff.
- 4/ With slide fastener dosed, measure from folded edge to folded edge.

NOTE

All measurements shall be taken with the undershirt laid out flat, slide fastener dosed and under no tension.

Table 23-2. Drawers Finished Measurements

SIZE	1/2 WAIST <u>1/</u> IN (CM)		INSEAM <u>2/</u> IN (CM)		1/2 LEG BOTTOM WIDTH <u>3/</u> IN (CM)	
26	11 1/2	(29.21)	27	(68.58)	5	(12.70)
28	12	(30.48)	27 1/2	(69.85)	5 1/8	(13.00)
30	12 1/2	(31.75)	28	(71.12)	5 1/4	(13.33)
32	13	(33.02)	28 1/2	(72.39)	5 3/8	(13.63)
34	13 1/2	(34.29)	29	(73.66)	5 1/2	(13.97)
36	14	(35.56)	29 1/2	(74.93)	5 5/8	(14.27)
38	14 1/2	(36.83)	30	(76.20)	5 3/4	(14.60)
40	15	(38.10)	30 1/2	(77.47)	5 7/8	(14.90)
42	15 1/2	(39.37)	31	(78.74)	6	(15.24)
Tolerance	±1/2		±1/2		±1/4	

1/ Measure along center of waistband from folded edge to folded edge.

2/ Measure inseam of drawers from crotch seam to bottom edge of drawers.

3/ Measure width of leg at hem from folded edge to folded edge of cuff.

NOTE

All measurements shall be taken with the drawers laid flat and under no tension.

23-8. CLEANING.

- a. General. The Chemical Protective Underwear (CPU) may be laundered an unlimited number of times during training life. Dirty clothes wear out quickly because dirt cuts textile fibers and retains moisture from perspiration. Prior to laundering and drying, make sure all slide fasteners are engaged and all fastener tapes are fastened. Securing these items will result in a better laundered garment.
- b. Stain/Spot Removal. (For training only)

NOTE

Do not bleach or dry clean CPU.

- (1) Following instructions on container, use a pre-wash or spot remover directly on the stain or spot followed by a standard laundry cycle with type II detergent.

23-8. CLEANING - Continued

c. Machine Laundering.

NOTE

- Do not use bleach or starch. Do not dry dean or steam press.
- When used, laundry pins shall be secured below the care label on the jacket flap, and on the trouser elastic waistband.
- Always mark the "next laundering" record box prior to any laundering with an indelible ink market. For field laundry the laundry operation personnel are responsible for marking the garments.

Use Formula II from FM 10-280 or Formula IV of "Natick Formulas" using warm water (90 to 110° F (32 to 63°C)) and type II detergent. Rinse thoroughly in dean, warm water.

Formula II is used to launder the Chemical Protective Undergarment (CPU). Three ounces of commercially available quaternary ammonium softener and bacteriostat is added in the second rinse. To reduce shrinkage and strain on the items, the washer should be fully loaded and stopped during filling and draining. Allow the extractor to reach top speed, and then shut it off. Be sure the tumbler is fully loaded. Dry the CPU's at a temperature not exceeding 120°F (49°C).

OPERATION	WATER LEVEL	TIME (MIN)	TEMPERATURE DEG. F/C	SUPPLIES
Suds	High	5	90/32	Detergent, type II, 6 oz.
Suds	High	5	90/32	Detergent, type II, 4 oz.
Rinse	High	2	90/32	
Rinse	High	2	90/32	
Rinse	High	2	90/32	Sour, 2 oz.

d. Drying. Tumble dry at low temperatures (110°F/43°C) and REMOVE IMMEDIATELY from the dryer. AVOID OVER DRYING. To drip dry, remove from water and place on a rust-proof hanger.

23-9. WORKMANSHIP.

Repair and cleaning will be done by personnel skilled in their duties.

23-10. INSPECTION.

After completing repair and/or cleaning, inspect each item and its components to determine if they meet the criteria in Chapter 1 listed under classification B. The inspection or quality control unit is responsible for preventing return of sub-standard product to supply channels.

Section III. MATERIALS

NOTE

Any materials may be used to repair the Item for training purposes as long as the design and general appearance is maintained.

FIG NO.	ITEM NO.	SMR CODE	NSN	DESCRIPTION	UNIT OF MEASURE																				
23-1	1	PAFZZ		Fastener Tape. Pile MIL-F-21840, Type I, Class I, Color Black, 1 inch wide - (Use NSN 8315-00-106-5974, Green, US Army 106)	YD																				
23-1	2	PAFZZ	8315-00-916-8399	Fastener Tape: Hook, MIL-F-21840, Type I, Class I, Color Black, 2 inch wide	YD																				
23-1	3	XDFZZ		Fastener, Slide: V-F-106, Type IV, Style 8, size M, Color Black <table border="0"> <tr> <td><u>Size</u></td> <td><u>Inches</u></td> </tr> <tr> <td>32</td> <td>27</td> </tr> <tr> <td>34</td> <td>27 3/4</td> </tr> <tr> <td>36</td> <td>28 1/2</td> </tr> <tr> <td>38</td> <td>29 1/4</td> </tr> <tr> <td>40</td> <td>30</td> </tr> <tr> <td>42</td> <td>30 3/4</td> </tr> <tr> <td>44</td> <td>31 1/2</td> </tr> <tr> <td>46</td> <td>32 1/4</td> </tr> <tr> <td>48</td> <td>33</td> </tr> </table>	<u>Size</u>	<u>Inches</u>	32	27	34	27 3/4	36	28 1/2	38	29 1/4	40	30	42	30 3/4	44	31 1/2	46	32 1/4	48	33	
<u>Size</u>	<u>Inches</u>																								
32	27																								
34	27 3/4																								
36	28 1/2																								
38	29 1/4																								
40	30																								
42	30 3/4																								
44	31 1/2																								
46	32 1/4																								
48	33																								
23-1	4	XBFZZ		Material, Body Source: DuPont, Part No. LANX I																					
23-1	5	XDFZZ		Thread, Polyester, Textured, A-A-52095, size TEX 35(T-35), Black	CE																				
23-1	6	PAFZZ	5640-00-103-2254	Tape, Duct	EA																				
23-1	7	XDFZZ		Thread, Polyester, Textured, A-A-52095, size TEX 45-50 (T-50), Black	CE																				
23-1	8	XDFZZ		Thread, Cotton-Covered, A-A-50199, 50/2 ply, Black	CE																				
23-1	9	XDFZZ		Thread, Cotton-Covered, A-A-50199, 70/2 ply, Black	CE																				

INDEX

Subject	Page	Subject	Page
A			
Aircrew Clothing		Bib Overall, Cold Weather, Fiberpile, 20-1	
Identification and Description of Items, 22-2		Classification, 1-13	
Introduction, 22-1		Materials, 20-36	
Publications, 22-2		Repair, 20-14	
Scope, 22-1		Boots, Knee, Rubber, Black, Non-Skid, 11-1	
Specifications, 22-1		Materials, 11-24	
		Repair, 11-22	
Aircrew Clothing, Maintenance of, 22-1		C	
Aircrew Clothing, Repair of, 22-6		Camouflage	
All Seasons Coat, Men's, Polyester/Wool Serge, 9-1		Cap, 8-1	
Materials, 9-16		Materials, 8-18	
Repair, 9-11		Repair, 8-8	
All-Weather Coat, Man's Black with Removable Liner, 9-1		Hat and Insect Net, 8-1	
Materials, 9-16		Materials, 8-18	
Repair, 9-11		Repair, 8-8	
Apron		Parka	
Food Handler's, 7-1		Extended Cold Weather, 20-1	
Classification, 20-5		Materials, 20-29	
Materials, 7-14		Repair, 20-14	
Repair, 7-7		Liner, Night, 12-1	
Toxicological Agents', 11-1		Materials, 12-18	
Materials, 11-24		Repair, 12-6	
Repair, 11-19		Snow, 6-1	
Arctic M-1950 and M-65 Trousers, Snow Camouflage, White, 6-1		Materials, 6-12	
Liner M-65, 12-1		Repair, 6-5	
Materials, 12-18		Trousers	
Repair, 12-6		Snow, White, Arctic M-1950 and M-65, 6-1	
Materials, 6-14		Materials, 6-14	
Repair, 6-5		Repair, 6-5	
Army Aviation High Temperature and Fire Retardant NOMEX Clothing, 3-1		Temperate, Desert, and Hot Weather, 15-1	
Materials, 3-33		Materials, 15-20	
Repair, 3-13		Repair, 15-13	
B		Caps	
Battledress Cap, 8-1		Classification, 20-5	
Materials, 8-18		Materials, 8-18	
Repair, 8-8		Repair, 8-8	
		Cleaning, 22-11	
		Cleaning, Repair and Maintenance of Two Piece Chemical Protective Underwear (Training Garments Only), 23-7	
		Cleaning, Repair Procedures, 22-11	
		Coat, Cold Weather, Liner, Materials, 20-34	
		Coat, Liner, Cold Weather, Materials, 20-34	
		Coated Poncho, Vinyl, Heavy Duty with Hood, 13-1	
		Materials, 13-11	

INDEX (Continued)

Subject	Page	Subject	Page
		Field Coat, 10-1	
Repair, 13-5		Liner, 12-1	
		Materials, 12-18	
Coats		Repair, 12-6	
Aircrew, Combat, Classification, 20-6		Materials, 10-25	
All Seasons, Polyester/Wool Serge, Man's, 9-1		Repair, 10-7	
Materials, 9-16		Hood, Baladavas, 20-1	
Repair, 9-11		Liner, Coat, 20-1	
All-Weather, Man's Black with Removable Liner, 9-1		Liner, Cold Weather Coat, Materials, 20-34	
Materials, 9-16		Liner, Cold Weather Trousers, Materials, 20-34.1	
Repair, 9-11		Liner, Trousers, Field, 20-1	
Camouflage Pattern, Temperate, Desert, and Hot Weather, 15-1		Overall, Fiberpile, 20-1	
Materials, 15-20		Classification, 1-13	
Repair, 15-13		Materials, 20-36	
Cold Weather, Field, 10-1		Repair, 20-14	
Liner, Cold Weather, 12-1		Parka, 20-1	
Materials, 12-18		Classification, 1-14	
Repair, 12-6		Materials, 20-29	
Materials, 10-25		Repair, 20-14	
Repair, 10-8		Ruff, Parka, Extended Cold Weather, 20-1	
Food Handler's, 7-1		Materials, 20-37	
Classification, 20-6		Shirt, Polyester Fiberpile, 20-1	
Materials, 7-14		Classification, 1-15	
Repair, 7-7		Materials, 20-34.1	
Service, Men's, 9-1		Repair, 20-14	
Materials, 9-16		Trousers, 20-1	
Repair, 9-11		Classification, 1-18	
Woman's: Classic Design, 18-1		Materials, 20-32, 20-34	
Materials, 18-17		Repair, 20-14	
Repair, 18-13		Undershirt, Polypropylene, 20-1	
Cold Weather (also see Extended Cold Weather and Extreme Cold Weather)		Materials, 20-36.1	
Cap, 8-1		Repair, 20-14	
Materials, 8-18		Combat Vehicle Crewmember's Fire Retardant NOMEX Clothing, 3-1	
Repair, 8-8		Classification, 1-6.1	
Clothing (Field): Coat, Parka and Trousers, 10-1		CWU-27P, Army Aviation, Fire Retardant NOMEX, 3-1	
Liners, 12-1		Classification, 1-6.1	
Materials, 12-18		Repair, 3-13	
Repair, 12-6		Explosive Handlers', 11-1	
Materials, 10-25		Materials, 11-24	
Repair, 10-7		Repair, 11-23	
Drawers, Polypropylene, 20-1		Materials, 3-36	
Materials, 20-36.1		Liner, 3-38	
Repair, 20-14		Mechanic's, Classification, 1-7	
		Repair, 3-13	
		Rocket Fuel Handlers' Limited and Full Protection, 11-1	
		Materials, 11-24	
		Repair, 11-13	

INDEX (Continued)

Subject	Page	Subject	Page
Toxicological Agents, 11-1		CPU (Undershirt and Drawers), Repair of, 23-4	
Materials, 11 -24		CVC High Temperature and Fire Retardant NOMEX	
Repair, 11-19		Clothing, 3-1	
Combat Vehicle Crewmember's High Temperature		Coverall, 3-1	
and Fire Retardant NOMEX Clothing		Materials, 3-33	
Coverall, 3-1		Liner, 3-38	
Materials, 3-36		Repair, 3-13	
Liner, 3-38		Jacket, 3-1	
Repair, 3-13		Classification, 1-8	
Jacket, 3-1		Materials, 3-34	
Classification, 1-8		Repair, 3-13	
Repair, 3-34		Overall	
Materials, 3-34		Materials, 3-38	
Repair, 3-13		Repair, 3-13	
Overall, 3-1		Shirt and Trousers, 3-1	
Materials, 3-38		Materials, 3-33	
Repair, 3-13		Repair, 3-13	
Shirt and Trousers, 3-1		CWU-27P Coverall, Army Aviation Fire Retardant	
Materials, 3-33		NOMEX, 3-1	
Repair, 3-13		Classification, 1-6.1	
Commodity Specifications, Repair and Maintenance		Repair, 3-13	
of Two Piece Chemical Protective Underwear			
(Training Garments Only), 23-1		D	
Cotton and Polyester/Poplin Raincoat, Men's, 13-1		Description, Identification and, 23-2	
Materials, 13-12		Desert Hat, 8-1	
Repair, 13-7		Materials, 8-18	
Cotton Trousers, Snow Camouflage, White, Arctic		Repair, 8-8	
M-1950, 6-1		Desert Night Camouflage	
Materials, 6-14		Parka, 16-1	
Repair, 6-5		Liner, 12-1	
Cotton Warp Nylon Filling Trousers; Snow Camou-		Materials, 12-18	
flage, White Arctic, M-65, 6-1		Repair, 12-6	
Materials, 6-14		Materials, 16-9	
Repair, 6-5		Repair, 16-6	
Cotton/Polyester and Wool Service Trousers, Men's,		Trousers, 16-1	
4-1		Materials, 16-9	
Materials, 4-13		Repair, 16-6	
Repair, 4-5		Drawers, Cold Weather, Polypropylene, 20-1	
Covers, Footwear, Toxicological Agents' Protective,		Classification, 1-8	
11-1		Materials, 20-36.1	
Materials, 11-24		Repair, 20-14	
Repair, 11-22		Dress, Food Handler's, 7-1	
		Materials, 7-14	
		Repair, 7-7	

INDEX (Continued)

Subject	Page	Subject	Page
Durable Press		Shirt, Men's, Wool/Nylon	5-1
Shirt, Utility, 2-1		Materials, 5-8	
Materials, 2-13		Repair, 5-4	
Repair, 2-6			
Trousers		Trousers, Men's, Extreme Cold Weather, 10-1	
Tan Polyester/Cotton, 4-1		Materials, 10-25	
Materials, 4-13		Repair, 10-7	
Repair, 4-5		Wool, 5-1	
Utility, 2-1		Materials, 5-8	
Materials, 2-13		Repair, 5-4	
Repair, 2-6			
		Fire Retardant NOMEX Clothing, High Temperature, and Army Aviation/CVC, 3-1	
E		Materials, 3-33	
ECWCS, 20-1		Repair, 3-13	
Materials, 20-29		Flight/CVC Gloves, Fire Retardant NOMEX, 3-1	
Repair, 20-14		Repair, 3-13	
Explosive Handlers' Coveralls, 11-1			
Materials, 11-24		Flyer's/CVC Fire Retardant NOMEX Clothing (Jackets, Shirts, and Trousers), 3-1	
Repair, 11-23		Materials, 3-33	
Extended Cold Weather Clothing System (ECWCS), Consisting of Parka, Trousers, Shirt, Overall, Drawers, and Undershirt, 20-1		Repair, 3-13	
Materials, 20-29		Food Handlers' Garments (Apron, Coat, Dress, and Trousers), 7-1	
Repair, 20-14		Materials, 7-14	
Extreme Cold Weather, 8-1		Repair, 7-7	
Hood, 8-1			
Materials, 8-18		Food Inspector and Meat Handlers' Smock, Man's, 7-1	
Repair, 8-8		Materials, 7-14	
Parka, 10-1		Repair, 7-7	
Liner, Man's Nylon Quilted, 12-1			
Materials, 12-18		Footwear Covers, Toxicological Agents Protective, 11-1	
Repair, 12-6als, 11-24		Materials, 11-24	
Materials, 10-25		Repair, 11-22	
Repair, 10-7		Fuel Handlers', Rocket Coveralls, 11-1	
		Materials, 11-24	
F		Repair, 11-13	
Fiberpile Cold Weather Bib Overall, 20-1		Hood, 11-1	
Materials, 20-36			
Repair, 20-14		Materials, 11-24	
		Repair, 11-18	
Field			
Coat, Cold Weather, 10-1		Fur Ruff Winter Hood, 8-1	
Materials, 10-25		Materials, 8-18	
Repair, 10-7		Repair, 8-8	

INDEX (Continued)

Subject	Page	Subject	Page
G			
Garments, Food Handlers', Men's and Women's, 7-1		Winter W/Fur Ruff, 8-1	
Materials, 7-14		Materials, 8-18	
Repair, 7-7		Repair, 8-8	
Gas Mask Hood, Toxicological Agent's, 11-1		Hood, Balacavas, Cold Weather, 20-1	
Materials, 11-24		Hot Weather Cap and Sun Hat, 8-1	
Repair, 11-21		Materials, 8-18	
General Purpose Smock, 7-1		Repair, 8-8	
Materials, 7-14		I	
Repair, 7-7		Identification and Description of Items, Maintenance of Aircrew Clothing, 22-2	
Gloves, Flight/CVC, Fire Retardant NOMEX, 3-1		Identification and Description, Repair and Maintenance of Two Piece Chemical Protective Underwear (Training Garments Only), 23-2, 23-4	
Repair, 3-13		Insect Net Hat, Camouflage, 8-1	
H		Materials, 8-18	
Hats, Camouflage, Insect Net, and Hot Weather Sun, 8-1		Repair, 8-8	
Materials, 8-18		Inspection	
Repair, 8-8		Inspection, Repair and Maintenance of Two Piece Chemical Protective Underwear (Training Gar- ments Only), 23-9	
Heavy Duty Poncho with Hood (Vinyl Coated), 13-1		Inspection, Repair Procedures, 22-11	
Materials, 13-11		Insulating Cap, Helmet Liner, 8-1	
Repair, 13-5		Materials, 8-18	
Helmet Liner Insulating Cap, 8-1		Repair, 8-8	
Materials, 8-18		Introduction, Maintenance of Aircrew Clothing, 22-1	
Repair, 8-8		J	
High Temperature and Fire Retardant NOMEX Clothing, Army Aviation/CVC, 3-1		Jacket, Flyer's/CVC, Fire Retardant NOMEX, 3-1	
Materials, 3-33		Classification, 1-8	
Repair, 3-13		Materials, 3-34	
Hood		Repair, 3-13	
Extreme Cold Weather, 8-1		K	
Classification, 1-8		Knee Boots, Rubber, Black, Non-Skid, 11-1	
Materials, 8-18		Materials, 11-24	
Repair, 8-8		Repair, 11-22	
Rocket Fuel Handlers' Full and Limited Protection, 11-1			
Materials, 11-24			
Repair, 11-12			
Toxicological Agents', 11-1			
Materials, 11-24			
Repair, 11-19			

INDEX (Continued)

Subject	Page	Subject	Page
L		M	
Limited Protection, Rocket Fuel Handlers'		M-1950 and M-65 Arctic Trousers, Snow	
Coveralls, 11-1		Camouflage, White, 6-1	
Materials, 11-24		Materials, 6-14	
Repair, 11-13		Repair, 6-5	
Hood, 11-1		Maintenance of Aircrew Clothing, 22-1	
Material, 11-24		Introduction, 22-1	
Repair, 11-18		Materials, 22-1, 22-12	
Liner		Repair Procedures, 22-1, 22-6	
Classification, 1-10		Aircrew Clothing, Repair of, 22-6	
Cold Weather Coat, Man's, 12-1		Cleaning, 22-6	
Materials, 12-18		Inspection, 22-6	
Repair, 12-6		Materials, 22-6	
Coverall, CVC, Fire Retardant, NOMEX, 3-1		Maintenance of Two Piece Chemical Protective Un-	
Materials, 3-36		derwear (Training Garments Only), Repair and,	
Repair, 3-13		23-1	
Helmet, Insulating Cap, 8-1		Man's	
Materials, 8-18		Coat Liner, Cold Weather, 12-1	
Repair, 8-8		Materials, 12-18	
Parka, Extreme Cold Weather and Night Camou-		Repairs, 12-6	
flage, 12-1		Raincoat, Quarpel, 13-1	
Materials, 12-18		Materials, 13-12	
Repair, 12-6		Repair, 13-7	
Trousers, Man's, Field, Nylon Quilted, 12-1		Shirt, Long and Short Sleeve, Polyester/Cotton,	
Materials, 12-18		14-1	
Repair, 12-6		Materials, 14-7	
Trousers, Snow Camouflage, White Arctic M-65,		Repair, 14	
12-1		Mask, Gas, Hood, Toxicological Agents', 11-1	
Materials, 12-18		Materials, 11-24	
Repair, 12-6		Repair, 11-18	
Wet Weather Poncho, 12-1		Materials, 22-6, 22-12	
Materials, 12-18		Materials, Repair and Maintenance of Two Piece	
Repair, 12-6		Chemical Protective Underwear (Training Gar-	
Liner, Coat, Cold Weather, 20-1		ments Only), 23-4	
Liner, Trousers, Field, Cold Weather, 20-1		Materials, Repair Procedures, 22-6	
Long Sleeve Shirt, Polyester/Cotton		Meat Handler and Food Inspectors Smock, Man's,	
Man's, 14-1		7-1	
Materials, 14-7		Materials, 7-14	
Repair, 14-4		Repair, 7-7	
Woman's Polyester/Cotton, 19-1		Men's	
Materials, 19-15		All-Weather Coats, 9-1	
Repair, 19-12		Materials, 9-16	
		Repair, 9-11	

INDEX (Continued)

Subject	Page	Subject	Page
Cotton and Polyester/Poplin Raincoat, 13-1		Repair, 16-6	
Materials, 13-12		Trousers, Desert, 16-1	
Repair, 13-7		Materials, 16-9	
Cotton/Polyester and Wool Service Trousers, 4-1		Repair, 16-6	
Materials, 4-13		NOMEX Clothing, High Temperature and Fire	
Repair, 4-5		Retardant, Army Aviation/CVC, 3-1	
Field Trousers, 10-1		Coverall, Combat Vehicle Crewmember's, 3-1	
Materials, 10-25		Materials, 3-36	
Repair, 10-7		Liner, 3-38	
Food Handlers' Garments, 7-1		Repair, 3-13	
Materials, 7-14		Coverall, CWP-27P, 3-1	
Repair, 7-7		Repair, 3-13	
Overcoats, 9-1		Flight Gloves, 3-1	
Materials, 9-16		Repair, 3-13	
Repair, 9-11		Flyer's Jacket, 3-1	
Service Coats, 9-1		Materials, 3-34	
Materials, 9-16		Repair, 3-13	
Repair, 9-11		Flyer's Shirt, 3-1	
Service Shirts, 14-1		Materials, 3-33	
Materials, 14-7		Repair, 3-13	
Repair, 14-4		Flyer's Trousers, 3-1	
Wool Serge Trousers, 4-1		Materials, 3-33	
Materials, 4-13		Repair, 3-13	
Repair, 5-4		Non-Skid Rubber Knee Boots, 11-1	
Wool, Wool-Nylon Trousers, 5-1		Materials, 11-24	
Materials, 5-8		Repair, 11-22	
Repair, 5-4		Nylon Poncho, Coated, 13-1	
Mitten Set, Classification, 1-12		Materials, 13-11	
		Repair, 13-5	
N		O	
Necktab, Women's Shirt, 19-1		Overall	
Materials, 19-14		Bib, Cold Weather, Fiberpile, 20-1	
Repair, 19-12		Classification, 1-13	
Net, Insect, Camouflage, 8-1		Materials, 20-36	
Materials, 8-18		Repair, 20-14	
Repair, 8-8		Combat Vehicle Crewmember's Fire Retardant	
Night Camouflage		NOMEX, 3-1	
Parka, Desert, 16-1		Materials, 3-38	
Materials, 16-9		Repair, 3-13	
Liner, 12-1		Overcoats, Men's, 9-1	
Repair, 12-6		Materials, 9-16	
		Repair, 9-11	

INDEX (Continued)

Subject	Page	Subject	Page
Oxford Cotton Trousers, Snow Camouflage, White, Arctic M-1950, 6-1		Polyester/Wool Trousers, 4-1	
Materials, 6-14		Materials, 4-13	
Repair, 6-5		Repair, 4-5	
P			
Parka		Polypropylene Cold Weather Drawers and Undershirt, 20-1	
Classification, 1-13		Materials, 20-36.1	
Extended Cold Weather, Camouflage, 20-1		Repair, 20-14	
Materials, 20-29		Poncho, Heavy Duty with Hood (Vinyl Coated), 13-1	
Repair, 20-14		Liner, Wet Weather, 12-1	
Extreme Cold Weather, 10-1		Materials, 12-18	
Materials, 10-25		Repair, 12-6	
Repair, 10-7		Materials, 13-11	
Liner, Extreme Cold Weather and Night Camouflage, 12-1		Repair, 13-5	
Materials, 12-18		Poplin/Cotton and Polyester Raincoat, Men's, 13-1	
Repair, 12-6		Materials, 13-11	
Night Camouflage, Desert, 16-1		Repair, 13-7	
Materials, 16-9		Protective Clothing	
Repair, 16-6		Rocket Fuel Handlers', 11-1	
Snow, Camouflage, 6-1		Materials, 11-24	
Materials, 6-12		Repair, 11-12	
Repair, 6-5		Toxicological Agents', 11-1	
Parka and Trousers, Wet Weather, 17-1		Materials, 11-24	
Classification, 1-14		Repair, 11-19	
Materials, 17-8		Publications, Maintenance of Aircrew Clothing, 22-2	
Repair, 17-4		Publications, Repair and Maintenance of Two Piece Chemical Protective Underwear (Training Garments Only), 23-2	
Polyester Fiberpile Shirt, Cold Weather, 20-1			
Classification, 1-15		Q	
Materials, 20-34.1		Quarrel Raincoat, 13-1	
Repair, 20-14		Materials, 13-12	
Polyester/Cotton Durable Press Trousers, Men's Tan, 4-1		Repair, 13-7	
Materials, 4-13		R	
Repair, 4-5		Raincoat, Men's Quarrel, 13-1	
Polyester/Wool Serge		Materials, 13-12	
Coat, Men's, All Season, 9-1		Repair, 13-7	
Materials, 9-16		Repair and Maintenance of Two Piece Chemical Protective Underwear (Training Garments Only), 23-1	
Repair, 9-11			
Trousers, 4-1			
Materials, 4-13			
Repair, 4-5			

INDEX (Continued)

Subject	Page	Subject	Page
Repair and Maintenance of Two Piece Chemical Protective Underwear (Training Garments Only)		Service Coat, Men's, 9-1	
Introduction		Materials, 9-16	
Commodity Specifications, 23-1		Repair, 9-11	
Identification and Description, 23-1		Service Shirt, Men's, 14-1	
Publications, 23-1		Materials, 14-7	
Scope, 23-1		Repair, 14-4	
Materials, 23-1		Service Trousers, Cotton/Polyester and Wool, Men's, 4-1	
Repair Procedures		Materials, 4-13	
Cleaning, 23-1		Repair, 4-5	
Inspection, 23-1		Shirt	
Materials, 23-1		Cold Weather, Polyester Fiberpile, 20-1	
Repair of CPU (Undershirt and Drawers), 23-1		Classification, 1-15	
Resizing, 23-1		Materials, 20-34.1	
Workmanship, 23-1		Repair, 20-14	
Repair of Aircrew Clothing, Repair Procedures, 22-6		Field, Nylon/Wool, 5-1	
		Materials, 5-8	
		Repair, 5-4	
Repair Procedures, Maintenance of Aircrew Clothing, 22-6		Flyer's ICVC Fire Retardant NOMEX, 3-1	
Resizing, Repair and Maintenance of Two Piece Chemical Protective Underwear (Training Garments Only), 23-6		Materials, 3-33	
		Repair, 3-13	
		Long Sleeve, Polyester Cotton	
		Men's, 14-1	
		Materials, 14-7	
		Repair, 14-4	
		Women's, 19-1	
		Materials, 19-15	
		Repair, 19-12	
		Service, 14-1	
		Materials, 14-7	
		Repair, 14-4	
		Short Sleeve, Polyester/Cotton	
		Men's, 14-1	
		Classification, 1-16	
		Materials, 14-7	
		Repair, 14-4	
		Women's, 19-1	
		Classification, 1-16	
		Materials, 19-15	
		Repair, 19-12	
		Utility, Durable Press, 2-1	
		Materials, 2-13	
		Repair, 2-6	
		Women's Necktab, 19-1	
		Materials, 19-15	
		Repair, 19-12	
		Wool, Wool-Nylon, 5-1	
		Materials, 5-8	
		Repair, 5-4	
S			
Scarf, Wool, Classification, 1-15			
Scope, Maintenance of Aircrew Clothing, 22-1			
Scope, Repair and Maintenance of Two Piece Chemical Protective Underwear (Training Garments Only), 23-1			

INDEX (Continued)

Subject	Page	Subject	Page
Skirt, Women's: Classic Design, 18-1		Trousers	
Materials, 18-17		Aircrew, Combat, Classification, 1-17	
Repair, 18-13		Cold Weather, Liner, Materials, 20-34.1	
Slacks, Women's: Classic Design, 18-1		Trousers, Classification, 1-18	
Materials, 18-17		Army, Tan 445, Polyester/Cotton, Durable Press, 4-1	
Repair, 18-13		Material, 4-13	
Smocks, Food Inspector and Meat Handler and		Repair, 4-5	
General Purpose, 7-1		Camouflage Pattern, 15-1	
Materials, 7-14		Materials, 15-20	
Repair, 7-7		Repair, 15-13	
Snow Camouflage Parka and Trousers, 6-1		Extended Cold Weather, Camouflage, 20-1	
Materials, 6-12		Materials, 20-32, 20-34	
Repair, 6-5		Repair, 20-14	
Trousers Liner, M-65, 12-1		Field, 10-1	
Materials, 12-18		Materials, 10-25	
Repair, 12-6		Repair, 10-7	
Specifications, Commodity, 23-1		Flyer's/CVC, Fire Retardant NOMEX, 3-1	
Specifications, Maintenance of Aircrew Clothing, 22-1		Materials, 3-33	
Sun Hat, Hot Weather, 8-1		Repair, 3-13	
Materials, 8-18		Food Handler's, 7-1	
Repair, 8-8		Materials, 7-14	
		Repair, 7-7	
		Men's, Field, Wool M-1951, 5-1	
		Materials, 5-8	
		Repair, 5-4	
		Night Camouflage, Desert, 16-1	
		Material, 16-9	
		Repair, 16-6	
		Polyester/Wool, 4-1	
		Materials, 4-13	
		Repair, 4-5	
		Polyester/Wool Serge, 4-1	
		Materials, 4-13	
		Repair, 4-5	
		Service, Cotton Polyester and Wool, Mens, 4-1	
		Materials, 4-13	
		Repair, 4-5	
		Snow, Camouflage, White, Arctic M-1950, Oxford Cotton, 6-1	
		Materials, 6-14	
		Repair, 6-5	
		Snow, Camouflage, White, Arctic M-65, Cotton Warp/Nylon Filling, 6-1	
		Liner, 12-1	
		Materials, 12-18	
		Repair, 12-6	
		Materials, 6-14	
		Repair, 6-5	

T

Tan Trousers, Men's Polyester/Cotton, Durable Press, 4-1	
Materials, 4-13	
Repair, 4-5	
Toxicological Agents' Protective Clothing, 11-1	
Apron, 11-1	
Materials, 11-19	
Repair, 11-19	
Coveralls, 11-1	
Materials, 11-24	
Repair, 11-19	
Footwear Covers, 11-1	
Materials, 11-24	
Repair, 11-22	
Gas Mask Hood, 11-1	
Materials, 11-24	
Repair, 11-21	

By Order of the Secretary of the Army:

CARL E. VUONO
General, United States Army
Chief of Staff

Official:

THOMAS F. SIKORA
Brigadier General, United States Army
The Adjutant General

DISTRIBUTION:

To be distributed in accordance with DA Form 12-25E, Unit, Direct and General Support Maintenance Requirements for Clothing Repair Shop, Trailer Mounted, Model D8700337, D8700860 and Clothing Repair Shop, Trailer Mounted, Model CRS.

RECOMMENDED CHANGES TO EQUIPMENT TECHNICAL PUBLICATIONS



THEN...JOT DOWN THE DOPE ABOUT IT ON THIS FORM. CAREFULLY TEAR IT OUT, FOLD IT AND DROP IT IN THE MAIL.

SOMETHING WRONG WITH PUBLICATION

FROM: (PRINT YOUR UNIT'S COMPLETE ADDRESS)

DATE SENT

PUBLICATION NUMBER

PUBLICATION DATE

PUBLICATION TITLE

BE EXACT PIN-POINT WHERE IT IS

PAGE NO.

PARA-GRAPH

FIGURE NO.

TABLE NO.

IN THIS SPACE, TELL WHAT IS WRONG AND WHAT SHOULD BE DONE ABOUT IT.

TEAR ALONG PREPARATED LINE

PRINTED NAME, GRADE OR TITLE AND TELEPHONE NUMBER

SIGN HERE

THE METRIC SYSTEM AND EQUIVALENTS

Linear Measure

1 centimeter = 10 millimeters = .39 inch
 1 decimeter = 10 centimeters = 3.94 inches
 1 meter = 10 decimeters = 39.37 inches
 1 dekameter = 10 meters = 32.8 feet
 1 hectometer = 10 dekameters = 328.08 feet
 1 kilometer = 10 hectometers = 3.2808.8 feet

Square measure

1 sq. centimeter = 100 sq. millimeters = .155 sq. in.
 1 sq. decimeter = 100 sq. centimeters = 15.5 inches
 1 sq. meter (centare) = 100 sq. decimeters = 10.76 feet
 1 sq. dekameter (are) = 100 sq. meters = 1.076.4 sq. ft.
 1 sq. hectometer (hectare) = 100 sq. dekameters = 2.47 acres
 1 sq. kilometer = 100 hectometers = .386 sq. miles

Weights

1 centigram = 10 milligrams = .15 grain
 1 decigram = 10 centigrams = 1.54 grains
 1 gram = 10 decigram = .035 ounce
 1 dekagram = 10 grams = .35 ounce
 1 hectogram = 10 dekagrams = 3.52 ounces
 1 kilogram = 10 hectograms = 2.2 pounds
 1 quintal = 100 kilograms = 220.46 pounds
 1 metric ton = 10 quintals = 1.1 short tons

Liquid Measure

1 dekaliter = 10 liters = 2.64 gallons
 1 hectoliter = 10 dekaliters = 26.42 gallons
 1 kiloliter = 10 hectoliters = 264.18 gallons
 1 liter = 10 deciliters = 33.81 fl. ounces
 1 centiliter = 10 milliliters = .34 fl. ounce
 1 deciliter = 10 centiliters = 3.38 fl. ounces
 1 metric ton = 10 quintals = 1.1 short tons

Cubic Measure

1 cu. centimeter = 1000 cu. millimeters = .06 cu. inch
 1 cu. decimeter = 1000 cu. centimeters = 61.02 cu. in.
 1 cu. meter = 1000 cu. decimeters = 35.31 cu. feet

Approximate Conversion Factors

To change	To	Multiply by	To change	To	Multiply by
inches	centimeters	2.540	ounce inches	newton-meters	.0070062
feet	meters	.305	centimeters	inches	.394
yards	meters	.914	meters	feet	3.280
miles	kilometers	1.609	meters	yards	1.094
sq. inches	sq. centimeters	6.451	kilometers	miles	.621
sq. feet	sq. meters	.093	sq. centimeters	sq. inches	.155
sq. yards	sq. meters	.836	sq. meters	sq. yards	10.764
sq. miles	sq. kilometers	2.590	sq. kilometers	sq. miles	1.196
acres	sq. hectometers	.405	sq. hectometers	acres	2.471
cubic feet	cubic meters	.028	cubic meters	cubic feet	35.315
cubic yards	cubic meters	.765	milliliters	fluid ounces	.034
fluid ounces	milliliters	29.573	liters	pints	2.113
pints	liters	.472	liters	quarts	1.057
quarts	liters	.946	grams	ounces	.035
gallons	liters	3.785	kilograms	pounds	2.205
ounces	grams	28.349	metric tons	short tons	1.102
pounds	kilograms	.454	pound-feet	newton-meters	1.356
short tons	metric tons	.907			
pound inches	newton-meters	.11296			

Temperature (Exact)

°F Fahrenheit temperature

5/9 (after subtracting 32)

Celsius Temperature °C

PIN: 028538-006